

PT-10 / PTC-10

10mm carbon / cermet through-hole potentiometer

The PT-10 and PTC-10 potentiometers offer control where frequent adjustment is required. The shaftless design allows for employment of different engagement mechanisms, such as a customized shaft, a motor control or a human interface adjustment. This potentiometer can also control variable outputs including frequency, change in motor speed or volume.

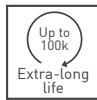

KEY FEATURES

- ▶ Excellent performance (up to 3% linearity)
- ▶ Carbon or cermet resistive element
- ▶ Up to 16 mechanical detents (stop positions) for tactile feedback
- ▶ Up to 100.000 life cycles
- ▶ IP54 protection
- ▶ Magazine packaging for automatic insertion available
- ▶ Polyester / Alumina substrate
- ▶ Wiper positioned at initial, 50% or fully clockwise
- ▶ Loose and assembled shaft and knobs
- ▶ Linear, logarithmic and anti-logarithmic tapers
- ▶ Self extinguishable plastic (UL 94V-0) available
- ▶ SPDT switch and low torque version available

On request

- ▶ Embossed tape packaging

ELECTRICAL SPECIFICATIONS

	PT-10 ((carbon)	PTC-10 (cermet)
Taper ¹	Lin, Log, Alog	
Range of values ¹	(Decad. 1.0 - 2.0 - 2.2 - 2.5 - 4.7 - 5.0)	
Lin	100Ω ≤ Rn ≤ 5MΩ	
Log, Alog	1KΩ ≤ Rn ≤ 5MΩ	
Standard Tolerance ¹		
100Ω ≤ Rn ≤ 1MΩ	± 20%	
1MΩ < Rn ≤ 5MΩ	± 30%	
Max. Voltage		
Lin	200 VDC	
Log, Alog	100 VDC	
Nominal power	50°C (122°F)	70°C (158°F)
Lin	0.15 W	0.33 W
Log, Alog	0.07 W	0.17 W
Residual resistance ¹	≤ 0.5% Rn (5Ω min.)	
Equivalent noise resistance	≤ 3% Rn (3Ω min.)	
Operating temperature	-25°C to +70°C ² (-13°F to + 158°F)	-40°C to +90°C ³ (-40°F to + 194°F)

1) Others available on request

2) Up to 85°C depending on application

3) +120°C/+248°F upon request

EXAMPLES OF APPLICATIONS

- ▶ Appliance program selection
- ▶ Thermostat adjustment
- ▶ Timer and control relays
- ▶ Consumer electronics
- ▶ Power tool controls
- ▶ Test and measurement equipment

PT-10 / PTC-10

10mm carbon / cermet through-hole potentiometer

MECHANICAL SPECIFICATIONS

	PT-10	PTC-10
Mechanical rotation angle ¹	235° ± 5°	
Electrical rotation angle ¹	220° ± 20°	
Torque Rotational Stop	0.4 to 2 Ncm (0.6 to 2.7 in-oz) > 5 Ncm (>7 in-oz)	
Push-pull force over the rotor	> 49N	
Life ²	Up to 100k cycles	Up to 10k cycles

¹ Endless rotation available: ST-10; ² Others check availability

ENVIRONMENTAL TESTING

	Test method (CEI 393-1)	PT-10 ΔR(%)- Piher typical test results	PTC-10 ΔR(%)- Piher typical test results
Electrical life	1.000h at 50°C; 0.15W 1.000h at 70°C; 0.33W	±5% n/a	n/a ±2%
Mechanical life	1000 cycles at 10 to 15 cpm	±3 % (Rn < 1M)	±2%
Temperature coefficient	-25°C; +70°C -40°C; +90°C	±300 ppm/°C (Rn < 100K) n/a	n/a ±100 ppm/°C
Thermal cycling	16h at 85°C and 2h at -25°C 16h at 90°C and 2h at -40°C	±2.5% n/a	n/a ±2%
Damp heat	500h at 40°C and 95% relative humidity (RH)	±5%	±2%
Vibration	2h each plane at 10Hz - 55Hz	±2%	±2%
Storage	6 month at 23°C ±2°C and 50% RH	±2.5%	±2%

Out of range values may not comply with these results. Standard test conditions: temperature:23°C ±2°C and 45% to 70% RH

RECOMMENDED CONNECTIONS

Recommended connection circuit for a position sensor or control application (voltage divider circuit electronic design).

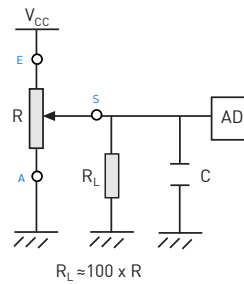

POWER RATING CURVE

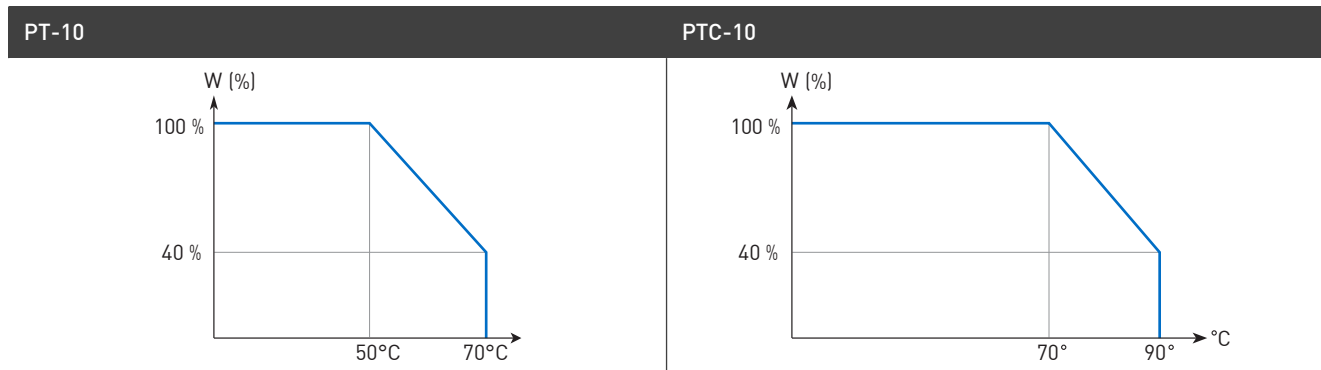

PT-10 / PTC-10

10mm carbon / cermet through-hole potentiometer

HOW TO ORDER

Carbon potentiometer

PT10	---	---	---	---	---	Optional features	---	---	---	---	S
Series	Mounting method²	Ω-Value³	Taper	Tolerance⁴	Life	Optional features	Cut track	Detents	Shaft/Knob	Shaft/Knob color	Torque
Rotors ¹	H01 horizontal adjust H04 H05 H07 crimped terminals H02 H10 V05 vertical adjust V10 V11 crimped terminals V13	101 = 100Ω 201 = 200Ω ... 504 = 500KΩ 505 = 5MΩ 000 = CM	A = lin. B = log. C = alog.	0505 = ±5% 0707 = ±7% 1010 = ±10% 2020 = ±20% 3030 = ±30% XXYY = +XX-YY%	[empty] = 1K cycles E = 10K cycles	Cut track [empty] PCI PCF	[empty] PAI PAM PAF P11 P1F P02 ... P16	[empty] = none 1 = Fig.1 2 = Fig.2 ... 18 = Fig.18	[empty] IN = not colored (natural) NE = black CR = cream	[empty] = standard L = ≤ 1 Ncm	
B G K L M R W inserted shaft X Y inserted knob Z						Flammability⁶ [empty] = standard I = non-flammable				Wiper position [empty] = initial PM = 50% PF = final	
						Packaging⁵ [empty] = bulk T = magazines					

🛒 check inventory

Cermet potentiometer

PTC10	---	---	---	---	---	Optional features	---	---	---	---
Series	Rotors¹	Mounting method²	Ω-Value³	Taper	Tolerance⁴	Optional features	Detents	Packaging	Shaft/knob color	Wiper position
B G K L M R W inserted shaft X Y inserted knob Z	H01 horizontal adjust H04 H05 H02 crimped terminals H10 V05 vertical adjust V10 V11 crimped terminals V13	101 = 100Ω 201 = 200Ω ... 504 = 500KΩ 505 = 5MΩ 000 = CM	A = lin. B = log. C = alog.	0505 = ±5% 0707 = ±7% 1010 = ±10% 2020 = ±20% 3030 = ±30% XXYY = +XX-YY%	[empty] = 1K cycles E = 10K cycles	Detents [empty] PAI PAM PAF P11 P1F P02 ... P16	[empty] = bulk T = magazines	[empty] = cream NE = black	[empty] = initial PM = 50% PF = final	
						Life [empty] = 1K cycles E = 10K cycles		Shaft/knob [empty] = none 1 = Fig.1 2 = Fig.2 ... 18 = Fig.18		Torque [empty] = standard L = ≤ 1 Ncm

🛒 check inventory

1. Rotors: "Z" adjustment only available on "H"-mounting versions. Rotor "G" only available in purple (color "V1")

2. Mounting method: "V05", "H07" terminals material: brass.

3. Ω- Value: XXX - First two digits of Ω-value 000 = CM = switch SPDT version
XXX - Number of zeros

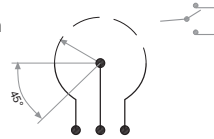

4. Tolerance: for custom tolerances please contact info@piher.net

5. Packaging: available options depend on mounting method, see "available packaging option" below. Embossed tape packaging on request.

6. Non-flammable according to UL 94V-0: housing, rotor and shaft. PTC-10 made of non-flammable material by standard.

ORDER CODE EXAMPLES

PT10LH01-103A2020-S

10mm carbon potentiometer with white rotor "L" (arrow shape), H01 mounting method (horizontal adjustment), 10K value, linear taper and 20% resistive tolerance.

PTC10WV05-104A1010-9-NE

10mm cermet potentiometer with rotor "W" (pre-inserted shaft), V05 mounting method (vertical adjustment), 100K resistive value, linear taper, 10% resistive tolerance and black ref. "9" shaft.

PT-10 / PTC-10

10mm carbon / cermet through-hole potentiometer

STANDARD CONFIGURATION

	PT-10	PTC-10
Life	1.000 cycles	
Cut track	no	n/a
Detents	none	
Packaging	bulk	
Shaft/knob/thumbwheel	none	
Non-flammability	no	yes
Housing color	black	cream
Rotor color	white	cream
Shaft/knob/thumbwheel color (if applicable)	Not coloured (natural)	cream
Wiper Position	initial	
Torque	0.4 to 2 Ncm	
Linearity*	not controlled	

* Others upon request

ROTORS

Without shaft or knob

L Screwdriver	M Hexagonal	G Hexagonal	K Cross slot	R	B

With inserted shaft

With inserted knob / thumbwheel

X Adjustable from collector side	W Adjustable from terminal side	Y Adjustable from terminal side Default knob is Fig. 5 - Ref. 5034	Z Adjustable from collector side Default knob is Fig. 5 - Ref. 5034

Default delivery is at initial position. Wipers are shown positioned at 50% for the picture.



Download the STEP files here:
www.pihernet.net

PT-10 / PTC-10

10mm carbon / cermet through-hole potentiometer

MOUNTING METHOD

Vertical adjust / Horizontal mounting - straight terminals

V05 - 5mm

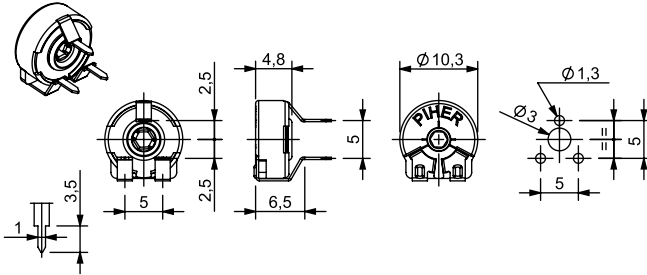

V10 - 10mm

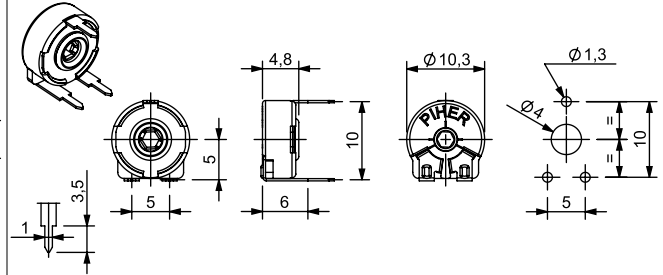

Vertical adjust / Horizontal mounting - crimped terminals

V11 - 10mm

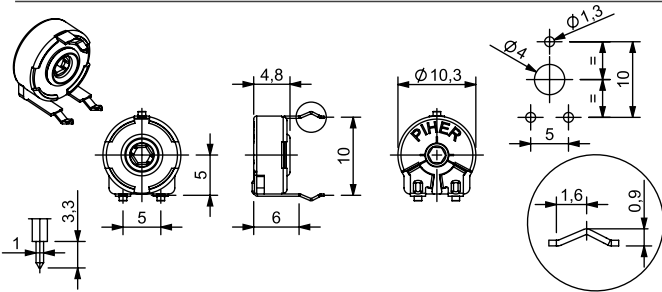

V13 - 10mm

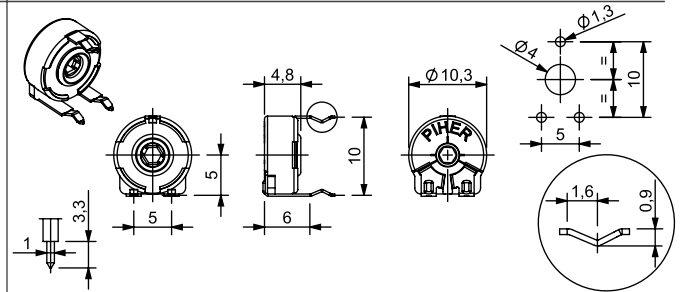

Horizontal adjust / Vertical mounting - straight terminals

H01 - 2.5mm

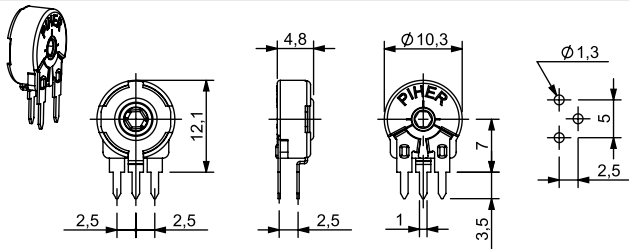

H04 - 3.8mm

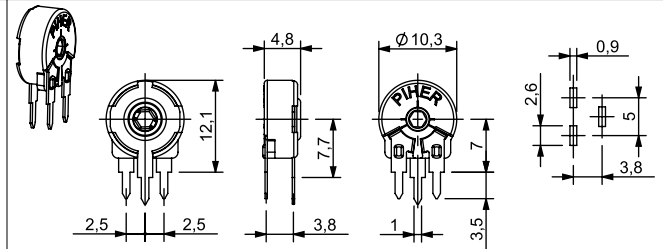

H05 - 5mm

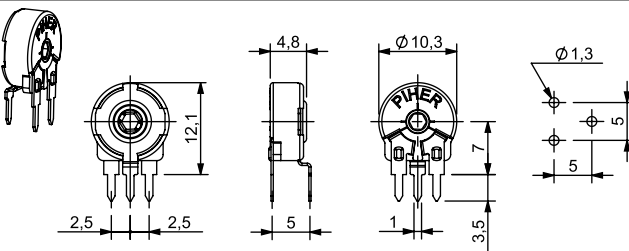

H07 - 3.8mm (only PT-10)

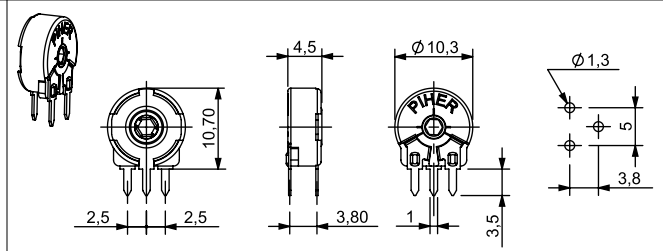

Horizontal adjust / Vertical mounting - crimped terminals

H02 - 2.5mm

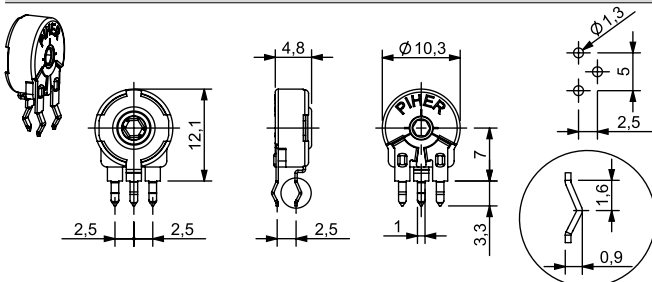

H10 - 5mm

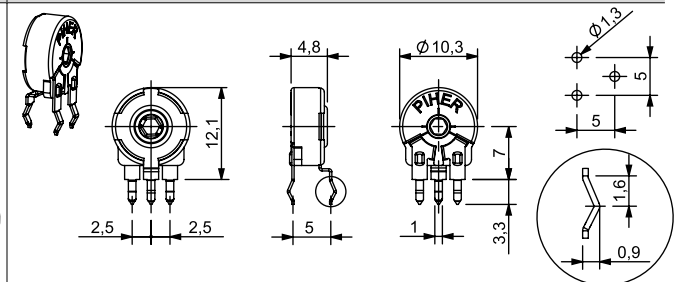

PT-10 / PTC-10

10mm carbon / cermet through-hole potentiometer

STANDARD RESISTANCE-VALUES AND TOLERANCES

Resistance Ω	100	200	220	250	470	500	1K	2K	2.2K	2.5K	4.7K	5K	10K	20K	22K	25K	47K	50K	100K	200K	220K	250K	470K	500K	1M	2M	2.5M	4.7M	5M
Order Code	101	201	221	251	471	501	102	202	222	252	472	502	103	203	223	253	473	503	104	204	224	254	474	504	105	205	255	475	505
Tolerance	20%																								30%				

SWITCH VERSIONS AVAILABLE WITH OR WITHOUT DETENTS

A80 Switch code

Switch standard specification

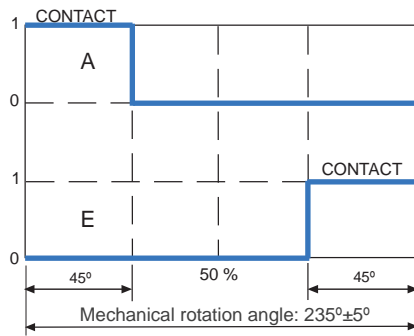

Power rating: 24V / 15mA
 ON position resistance: $\leq 5\Omega$
 Insulation resistance: $\geq 30M\Omega$

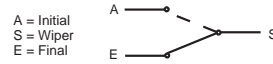

Contact Piher Sensing Systems for ordering information.

TAPERS

Standard

Example: special custom taper

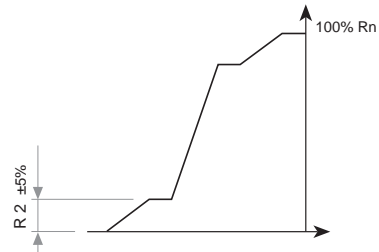
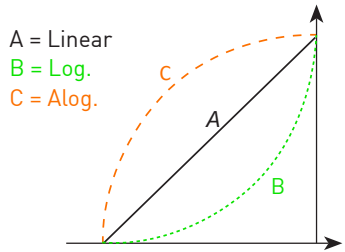

For more information on custom tapers contact Piher Sensing Systems.

CUT TRACKS (OPEN CIRCUIT DESIGN)

PCI

PCF

CCW on-of (A)

Cut track at the beginning of travel.

Cut track at the end of travel.

CW on-of (E)

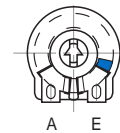
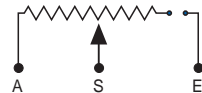
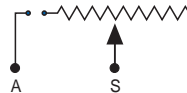
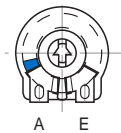

Other configurations available upon request. Cut Track not available for PTC-10.

PT-10 / PTC-10

10mm carbon / cermet through-hole potentiometer

DETENTS							
PAM	P1i	P1F	P02	P03	P04	P05	P06
P07	P08	P09	P10	P11	P12	P13	P16
PAI		PID		PFD		PAF	
<p>(wiper positioned at initial)</p>		<p>A = 26°</p>		<p>B = 27.5°</p>		<p>(wiper positioned at final)</p>	
<p>— Relative detent positions along total mechanical travel</p>							

Standard mechanical life is 500 cycles.
 Long life versions are available upon request and have the following characteristics at T^a: Potentiometers with 1 to 3 detents up to 10K cycles; Potentiometers with 4 and more detents up to 5K cycles.
 Please consult Piher Sensing Systems if unique non-overlapping values at each detent position or LOG/ALOG tapers are required.
 Different output voltage values can be matched at each detent position (see next section).
 Detent torque can vary from 1.2 to 2.5 times the standard potentiometer torque.
 For more than 16 detents versions please contact Piher Sensing Systems.

STEPPED OUTPUTS / CONSTANT VALUE ZONES

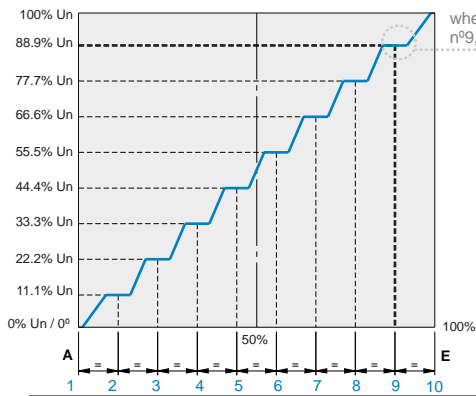

when the potentiometer's wiper position is located at detent n°9, the output voltage will be 88.9% Un ± % tolerance.

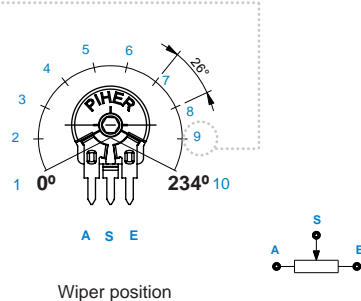

IMPROVED REPEATABILITY

Constant value zones can be combined with strategically located mechanical detents to provide exact alignment between the electrical output (flat areas) and the mechanical detent position. This provides clear mechanical positions that are not only repeatable, but perfectly aligned electrical outputs at each of the (detent) angles. The detents also prevent output values from changing due to vibration or accidental rotor movements. The result is a higher level of precision in controlling lighting, temperature, motor or other electronic control systems.

Contact Piher Sensing Systems for ordering information.

PT-10 / PTC-10

10mm carbon / cermet through-hole potentiometer

PACKAGING

Bulk



Dimensions (mm): 185x85x80

Without shaft: 1000 units per box

With Thumbweel: 800 units per box

With shaft: 400 units per box

Magazine for automatic insertion (50 units)

Horizontal adjust

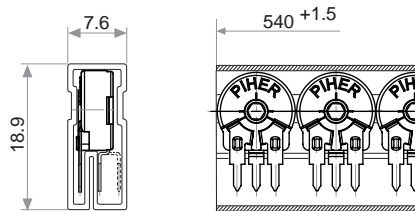

Vertical adjust

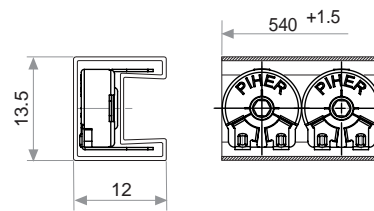

AVAILABLE PACKAGING OPTIONS

Mounting Type	Terminal Style	Mounting Method	Bulk	Magazine
Horizontal adjust	Straight	H01	x	x
		H04	x	x
		H05	x	x
		H07	x	x
	Crimped	H02	x	x
		H10	x	
Vertical adjust	Straight	V05	x	
		V10	x	x
	Crimped	V11	x	x
		V13	x	

Rotor Type X, W, Y, Z only in bulk packaging. Embossed tape packaging on request.

PT-10 / PTC-10

10mm carbon / cermet through-hole potentiometer

SHAFTS, KNOBS, THUMBWHEELS (TOP VIEW, FOR G AND M ROTOR TYPES)

<p>Fig. 1 - Ref. 5016</p>	<p>Fig. 3 - Ref. 5012</p>	<p>Fig. 4 - Ref. 6053</p>	<p>Fig. 5 - Ref. 5034</p>	<p>Fig. 12 - Ref. 6052</p>	<p>Fig. 14 - Ref. 5055</p>
<p>Fig. 7 - Ref. 5115</p>	<p>Fig. 8 - Ref.: 5116</p>	<p>Fig. 9 - Ref 5119</p>	<p>Fig. 10 - Ref. 5120</p>	<p>Fig. 17 - Ref. 5062</p>	
<p>Fig. 15 - Ref. 6008</p>	<p>Fig. 16 - Ref. 5039</p>	<p>Upon request: thumb-wheel with configurable numbers or texts</p> <p>Example of four positions marking thumbwheel for rotor R</p>			

Fig. 18 - Ref: 6064
2-gang plastic knob/shaft

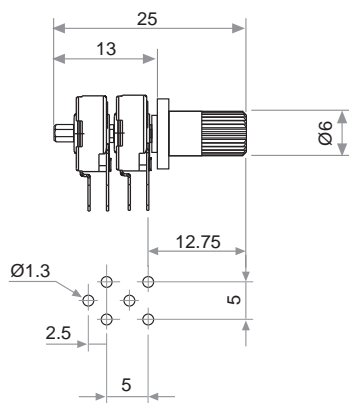

Shafts, thumbwheels and knobs are delivered unassembled if not specified otherwise in the part number code.

The position of assembled knobs Fig 5, 15, 16 can be indicated in the part number code: Initial (default), 50% (PM) or Final (PF). Others will be delivered at random position by default.

Custom specific positions are available for all shafts and knobs, on request.

Non flammable plastic available, if potentiometer is ordered with non-flammable plastic (UL-94V0), the shaft or knob will be delivered with non-flammable plastic too.

If you wish to use your own plastic shaft/ knob/actuator please contact us for advice about compatible materials.

PT-10 / PTC-10

10mm carbon / cermet through-hole potentiometer

POSITIONING

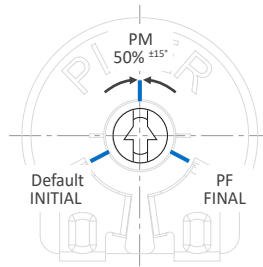

Default wiper position is initial. Custom delivery positions available on request.
Default wiper positioning tolerance is ± 15 deg. Other tolerances available on request.

OUR ADVANTAGE

- ▶ Leading-edge innovative position sensing solutions
 - ▷ Contactless (Hall-effect and Inductive Technology)
 - ▷ Contacting (Potentiometers, Printed Electronics)
- ▶ Engineering design-in support
- ▶ All our products can be customized to fit target application and customer requirement
- ▶ Capability to move seamlessly from development to true high-volume production
- ▶ A global footprint with global manufacturing, engineering and commercial support
- ▶ One-stop shop not limited to position sensors (temperature, pressure, gas,...) through group collaboration
- ▶ Flexibility and entrepreneurship of a medium-sized company with the backing of Amphenol Corporation



Please always use the latest updated datasheets and 3D models published on our website.

Disclaimer:

The product information in this catalog is for reference purposes. Please consult for the most up to date and accurate design information. Piher Sensors & Controls S.A., its affiliates, agents, and employees, and all persons acting on its or their behalf (collectively, "Piher"), disclaim any and all liability for any errors, inaccuracies or incompleteness contained herein or in any other disclosure relating to any product described herein. Piher disclaims any and all liability arising out of the use or application of any product described herein or of any information provided herein to the maximum extent permitted by law. The product specifications do not expand or otherwise modify Piher's terms and conditions of sale, including but not limited to the warranty expressed therein, which apply to these products. No license, express or implied, by estoppel or otherwise, to any intellectual property rights is granted by this document or by any conduct of Piher. The products shown herein are not designed for use in medical, life-saving, or life-sustaining applications unless otherwise expressly indicated. Customers using or selling Piher products not expressly indicated for use in such applications do so entirely at their own risk and agree to fully indemnify Piher for any damages arising or resulting from such use or sale. Please contact authorized Piher personnel to obtain written terms and conditions regarding products designed for such applications. Product names and markings noted herein may be trademarks of their respective owners. Information contained in and/or attached to this catalog may be subject to export control regulations of the European Community, USA, or other countries. Each recipient of this document is responsible to ensure that usage and/or transfer of any information contained in this document complies with all relevant export control regulations. If you are in any doubt about the export control restrictions that apply to this information, please contact the sender immediately. For any Piher Exports, Note: All products / technologies are EAR99 Classified commodities. Exports from the United States are in accordance with the Export Administration Regulations. Diversion contrary to US law is prohibited.

CONTACT

Piher Sensing Systems

Polígono Industrial Municipal
Vial T2, N°22
31500 Tudela
Spain

sales@piher.net

+34 948 820 450



NEED QUICK HELP?

Our AI Virtual Assistant is available
24/7 to provide instant support—
[click here to chat now!](#)

Rev. 23102024 © Piher Sensors & Controls S.A.