



ShenZhen inanbo Electronic Co., LTD.

2011

Website:<http://www.inanbo.com>

Rambo.wen

SPECIFICATION OF TFT MODULE

FOR INANBO-T32-SSD1289-V11

Remark:



Contents

Contents

Contents	1
REVISION RECORD	3
GENERAL INFORMATION	4
ABSOLUTE MAXIMUM RATINGS.....	4
ELECTRICAL CHARACTERISTICS DC CHARACTERISTICS	4
TIMING OF POWER SUPPLY	5
BACKLIGHT CHARACTERISTICS	5
EXTERNAL DIMENSIONS	6
FIG. 1 Optical Characteristic Measurement Equipment and Method.....	9
FIG. 2 Measuring method for optical characteristics in Reflective mode.....	9
FIG. 3 The definition of Response Time.....	10
FIG. 4 Measuring method for Contrast ratio,surface luminance, Luminance uniformity ,CIE (x, y) chromaticity.....	10
FIG. 5 The definition of viewing angle.....	11
INTERFACE DESCRIPTION	11
APPLICATION CIRCUIT	12
INITIAL CODE	12
RELIABILITY TEST.....	12
PRECAUTIONS FOR USING LCD MODULES	13
Handling Precautions	13
Handling precaution for LCM	16
Handling precaution for LCD	17
Handling precaution for Touch panel.....	18
Storage Precautions	18
Others.....	19
USING LCD MODULES.....	19
Installing LCD Modules	19



Precaution for assemble the module with BTB connector:	20
Precaution for soldering the LCM	20
Precautions for Operation.....	21
Safety.....	22
Limited Warranty.....	22
Return LCM under warranty.....	22
PACKING SPECIFICATION	22
PRIOR CONSULT MATTER	23



INANBO

REVISION RECORD

REV NO.	REV DATE	CONTENTS	REMARKS
V10.1	2010-06-06	First Release	
V11	2011-11-06	V11 Release	FPC ICON
V11.1	2011-11-12	EXDIM	



GENERAL INFORMATION

Item	Contents	Unit
LCD Type	TFT TRANSMISSIVE	/
Viewing direction	9:00	O' Clock
Glass area (W × H)	52.74 × 74.40	mm ²
Active area (W×H)	48.60 × 64.80	mm ²
Number of Dots	240(RGB) ×320	/
Driver IC	SSD1289Z	/
Colors	262K	/
Backlight Type	LED	/
Module Power consumption	290(typ)	mw
Interface Type	System parallel interface	
Input voltage	2.8	V

ABSOLUTE MAXIMUM RATINGS

Parameter	Symbol	Min	Max	Unit
Supply voltage for logic	VDD	-0.3	4.0	V
Input voltage	VIN	-0.3	VDD+5.0	V
Operating temperature	TOP	-20	70	°C
Storage temperature	TST	-30	80	°C
Humidity	RH		90%(Max60°C)	RH

ELECTRICAL CHARACTERISTICS DC CHARACTERISTICS

DC CHARACTERISTICS

Parameter	Symbol	Min	Typ	Max	Unit
Supply voltage for logic	VDD-VSS	2.7	2.8	2.9	V
Input Current	I _{dd}	-	15.59	23.38	mA
Input voltage ' H ' level	V _{IH}	0.8VDD	VDD	VDD	V
Input voltage ' L ' level	V _{IL}	0	0	0.2VDD	V
Output voltage ' H ' level	V _{OH}	0.8VDD	VDD	VDD	V
Output voltage ' L ' level	V _{OL}	0	0	0.2VDD	V



INANBO

TIMING OF POWER SUPPLY

PLEASE REFER TO THE DRIVER IC SPECIFICATION.

BACKLIGHT CHARACTERISTICS

Item	Symbol	Min.	Typ.	Max.	Unit	Condition
Forward voltage	Vf	3.0	3.2	3.4	V	If= 75 mA
Luminance	Lv	2800	3300	3800	cd/m ²	
Number of LED	-		5		Piece	-
Connection mode	p		parallel			-



INANBO

EXTERNAL DIMENSIONS

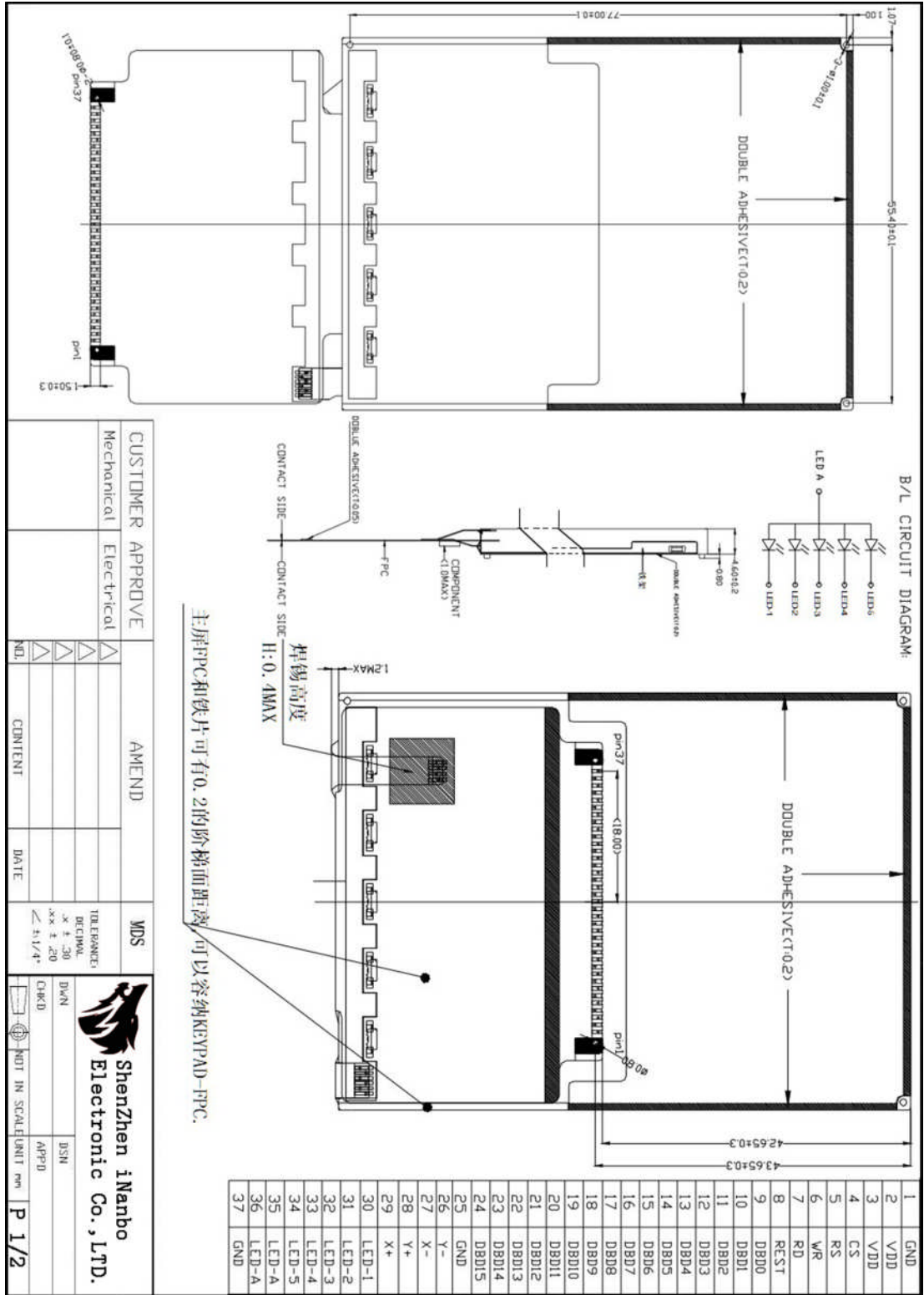

主屏FPC和铁片可有0.2的阶梯面距离 可以容纳KEYPAD-FPC.

CUSTOMER APPROVE	Mechanical	Electrical	AMEND	MDS	TOLERANCE: DIM: ±.30 X: ±.20 XXX: ±.20 ◁ ±1/4°	<p>Shenzhen Inanbo Electronic Co., Ltd.</p>	D/SN	APPD	NOT IN SCALE UNIT mm	P 1/2
	AMEND	DATE								



INANBO

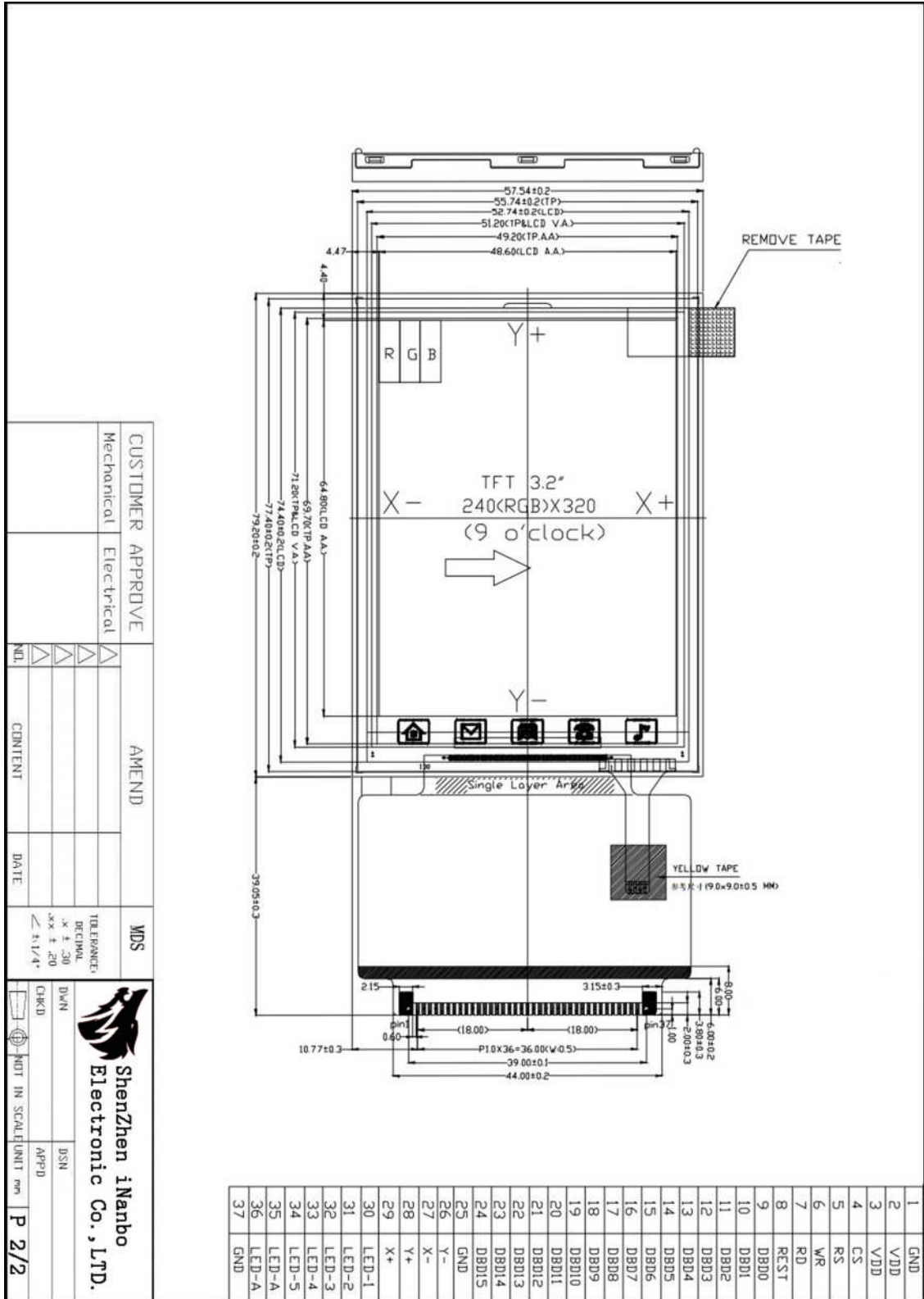

CUSTOMER APPROVE		AMEND		MDS	
Mechanical	Electrical			TOLERANCES	
Δ	Δ	Δ	Δ	DECIMAL	DRAW
Δ	Δ	Δ	Δ	XXX ± .20	CHKD
Δ	Δ	Δ	Δ	±1/4"	UNIT mm
COMMENT		DATE		P 2/2	

Shenzhen iNanbo
Electronic Co., LTD.

1	GND
2	VDD
3	VDD
4	CS
5	RS
6	WR
7	RD
8	REST
9	DB00
10	DB01
11	DB02
12	DB03
13	DB04
14	DB05
15	DB06
16	DB07
17	DB08
18	DB09
19	DB010
20	DB011
21	DB012
22	DB013
23	DB014
24	DB015
25	GND
26	Y-
27	X-
28	Y+
29	X+
30	LED-1
31	LED-2
32	LED-3
33	LED-4
34	LED-5
35	LED-A
36	LED-A
37	GND



ELECTRO-OPTICAL CHARACTERISTICS

Item	Symbol	Condition	Min	Typ	Max	Unit	Remark	Note	
Response time	Tr+Tf		---	---	---	ms	FIG.3	4	
			120	160	---	---	FIG 4.	1	
Contrast ratio	Cr	$\theta=0^\circ$							
Luminance uniformity	δ WHITE	$\phi=0^\circ$ Ta=25 °C	70	80	---	%	FIG 4.	3	
Surface Luminance	Lv		120	160	---	cd/m ²	FIG 4.	2	
Viewing angle range	θ	$\phi = 90^\circ$	50	60	---	deg	FIG 5.	6	
		$\phi = 270^\circ$	50	60	---	deg	FIG 5.	6	
		$\phi = 0^\circ$	30	40	---	deg	FIG 5.	6	
		$\phi = 180^\circ$	50	60	---	deg	FIG 5.	6	
CIE (x, y) chromaticity	Red	$\theta=0^\circ$ $\phi=0^\circ$ Ta=25°C	x	0.57	0.62	0.67		FIG 4.	5
			y	0.29	0.34	0.39			
	Green		x	0.27	0.32	0.37			
			y	0.55	0.60	0.65			
	Blue		x	0.09	0.14	0.19			
			y	0.02	0.07	0.12			
	White		x	0.24	0.30	0.36			
			y	0.25	0.31	0.37			

Note 1. Contrast Ratio(CR) is defined mathematically as For more information see FIG 4.:

$$\text{Contrast Ratio} = \frac{\text{Average Surface Luminance with all white pixels (P 1,P2, P 3,P4, P5)}}{\text{Average Surface Luminance with all black pixels (P1, P2, P 3,P4, P5)}}$$

Note 2. Surface luminance is the center point across the LCD surface 500mm from the surface with all pixels displaying white. For more information see FIG 4.

Lv = Average Surface Luminance with all white pixels (P1, P2, P 3, P4, P5)

Note 3. The uniformity in surface luminance , δ WHITE is determined by measuring luminance at each test position 1 through 5, and then dividing the maximum luminance of 5 points luminance by minimum luminance of 5 points luminance. For more information see FIG 4.

$$\delta \text{ WHITE} = \frac{\text{Minimum Surface Luminance with all white pixels (P1, P2, P 3, P4, P5)}}{\text{Maximum Surface Luminance with all white pixels (P1, P2, P 3, P4, P5)}}$$

Note 4. Response time is the time required for the display to transition from White to black(Rise Time, Tr) and from black to white(Decay Time, Tf). For additional information see FIG 3.



Note 5. CIE (x, y) chromaticity, The x, y value is determined by measuring luminance at each test position 1 through 5, and then make average value

Note 6. Viewing angle is the angle at which the contrast ratio is greater than 2, for TFT module the contrast ratio is greater than 10. The angles are determined for the horizontal or x axis and the vertical or y axis with respect to the z axis which is normal to the LCD surface. For more information see FIG 5.

FIG. 1 Optical Characteristic Measurement Equipment and Method

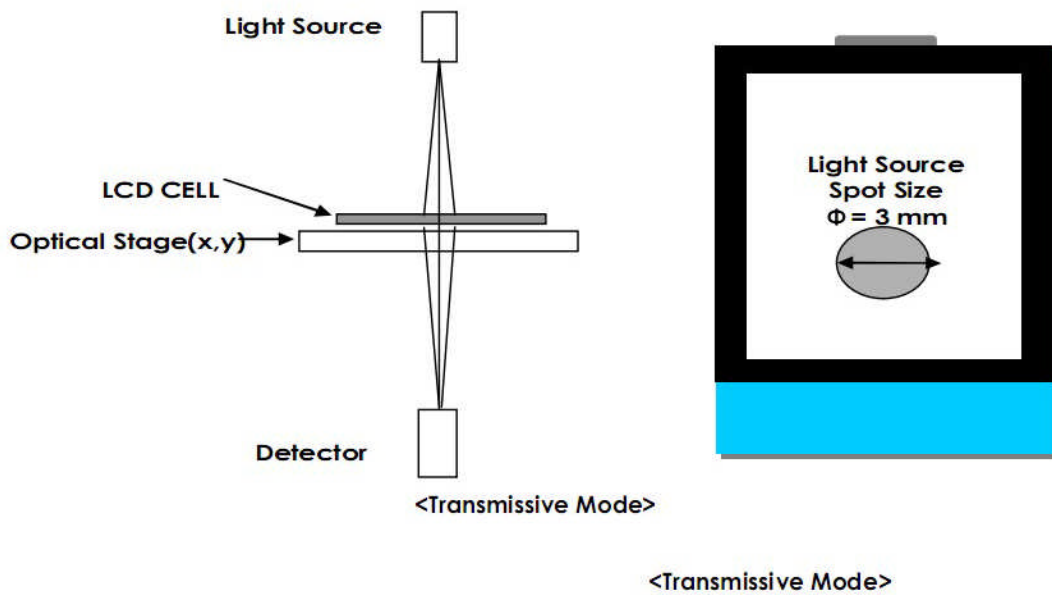

FIG. 2 Measuring method for optical characteristics in Reflective mode

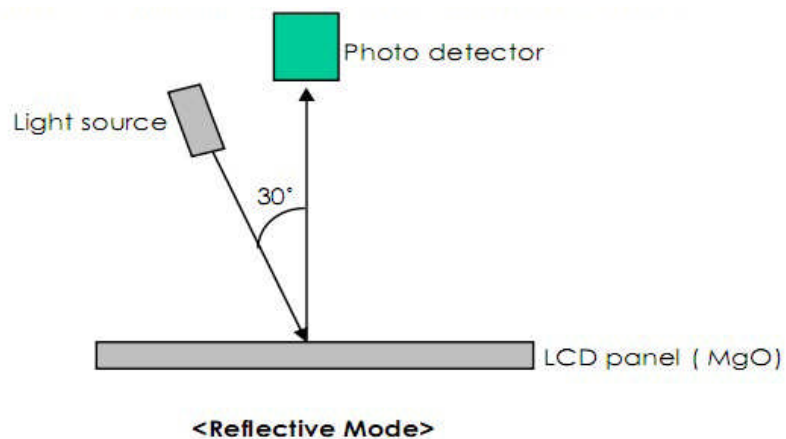
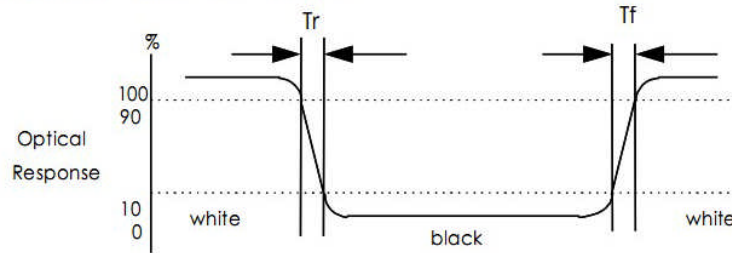



FIG. 3 The definition of Response Time

The response time is defined as the following figure and shall be measured by switching the input signal for “black” and “white”.



The values specified are at an approximate distance 500 mm from the LCD surface at a viewing angle of θ and θ equal to 0° . Measurement condition : Refer to next pages (B - light source , Halogen Lamp, with polarizer)

FIG. 4 Measuring method for Contrast ratio, surface luminance, Luminance uniformity, CIE (x, y) chromaticity

<measuring point for luminance variation> <measuring point for surface luminance>

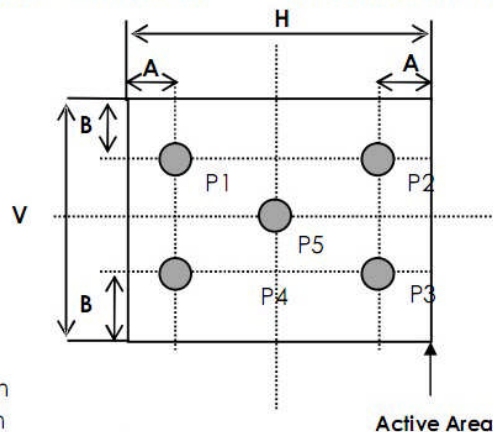

A : 5 mm

B : 5 mm

Light source spot size $\varnothing=2\text{mm}$

H,V : Active Area

measurement device is TOPCON luminance meter BM-7



FIG. 5 The definition of viewing angle

<dimension of viewing angle range>

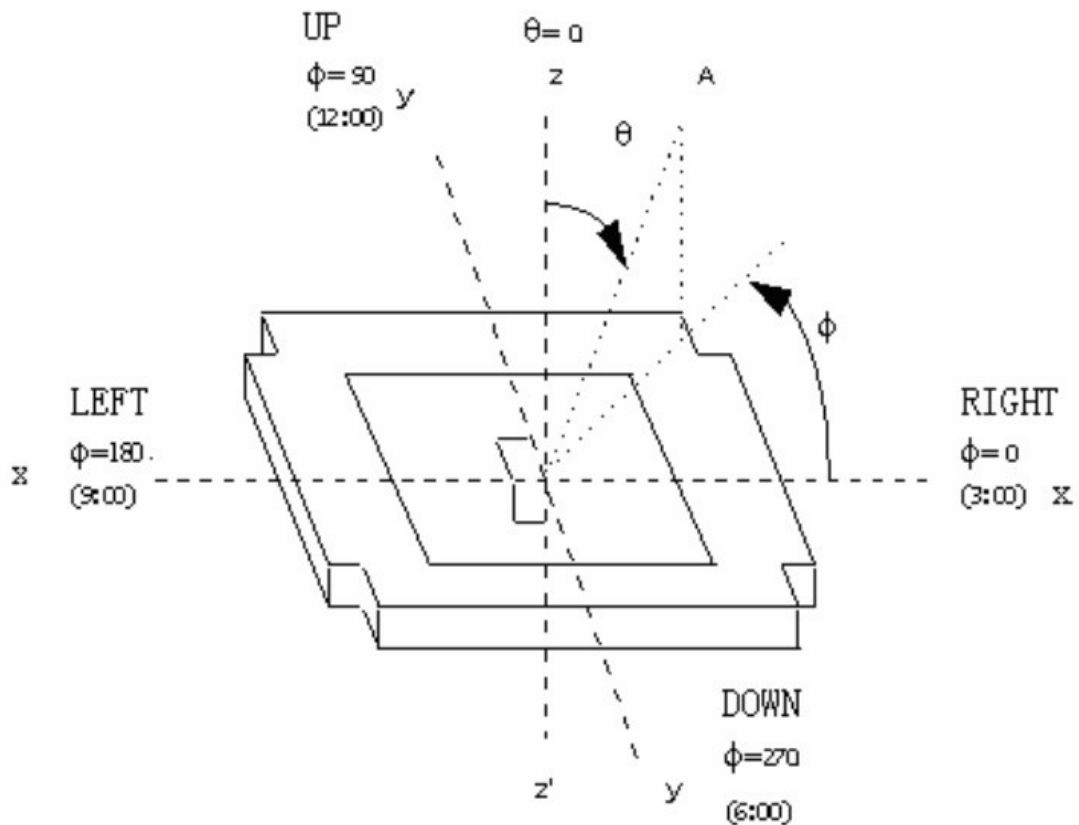

INTERFACE DESCRIPTION

Pin No.	Symbol	Level	Description
1	GND	VSS	Ground.
2	VDD	2.8V	Power supply for LCD.
3	VDD	2.8V	Power supply for LCD.
4	CS	H/L	Chip selection.
5	RS	H/L	Command / data select pin.
6	WR	H/L	Write signal.
7	RD	H/L	Read signal.
8	REST	H/L	Reset signal.
9~24	DBD0~DBD15	H/L	Data bus.
25	GND	VSS	Ground.



26	Y-	-	Touch panel coordinate in the down side of envisage drawing.
27	X-	-	Touch panel coordinate in the left side of envisage drawing.
28	Y+	-	Touch panel coordinate in the up side of envisage drawing.
29	X+	-	Touch panel coordinate in the right side of envisage drawing.
30	LED-1	-	LED light cathode.
31	LED-2	-	LED light cathode.
32	LED-3	-	LED light cathode.
33	LED-4	-	LED light cathode.
34	LED-5	-	LED light cathode.
35	LED-A	-	LED light anode.
36	LED-A	-	LED light anode.
37	GND	VSS	Ground.

APPLICATION CIRCUIT

Please consult our technical department for detail information.

INITIAL CODE

Please consult our technical department for detail information

RELIABILITY TEST

No.	Test Item	Test Condition	Inspection after test
1	High Temperature Storage	80±2 °C /200 hours	Inspection after 2~4hours storage at room temperature, the sample shall be free from defects: 1.Air bubble in the LCD; 2.Sealleak; 3.Non-display; 4.missing segments; 5.Glass crack;
2	Low Temperature Storage	-30±2 °C /200 hours	
3	High Temperature Operating	70±2 °C /120 hours	
4	Low Temperature Operating	-20±2 °C /120 hours	
5	Temperature Cycle	-20±2 °C ~25~ 70±2 °C × 10cycles (30min.)	
6	Damp Proof Test	50 °C ±5 °C ×90%RH/120 hours	
7	Vibration Test	Frequency:10Hz~55Hz~10Hz	



		Amplitude:1.5mm,X,Y,Z direction for total 3hours (Packing condition)	6.Current Idd is twice higher than initial value.
8	Drooping test	Drop to the ground from 1m height, one time, every side of carton.(Packing condition)	
9	ESD test	Voltage:±8KV	

Remark:

- 1.The test samples should be applied to only one test item.
 - 2.Sample size for each test item is 5~10pcs.
 - 3.For Damp Proof Test, Pure water(Resistance>10MΩ) should be used.
 - 4.In case of malfunction defect caused by ESD damage, if it would be recovered to normal state after resetting, it would be judge as a good part.
- Using ionizer(an antistatic blower) is recommended at working area in order to reduce electro-static voltage.
- When removing protection film from LCM panel, peel off the tag slowly(recommended

PRECAUTIONS FOR USING LCD MODULES

Handing Precautions

- (1) The display panel is made of glass and polarizer. As glass is fragile. It tends to become or chipped during handling especially on the edges. Please avoid dropping or jarring. Do not subject it to a mechanical shock by dropping it or impact.
- (2) If the display panel is damaged and the liquid crystal substance leaks out, be sure not to get any in your mouth. If the substance contacts your skin or clothes, wash it off using soap and water.
- (3) Do not apply excessive force to the display surface or the adjoining areas since this may cause the color tone to vary. Do not touch the display with bare hands. This will stain the display area and degraded insulation between terminals (some cosmetics are determined to the polarizer).
- (4) The polarizer covering the display surface of the LCD module is soft and easily scratched. Handle this polarizer carefully. Do not touch, push or rub the exposed polarizers with anything harder than an HB pencil lead (glass, tweezers, etc.). Do not put or attach anything on the display area to avoid leaving marks on. Condensation on the surface and contact with terminals due to cold will damage, stain or dirty the polarizer. After products



are tested at low temperature they must be warmed up in a container before coming in contact with room temperature air.

(5) If the display surface becomes contaminated, breathe on the surface and gently wipe it with a soft dry cloth. If it is heavily contaminated, moisten cloth with one of the following solvents

- Isopropyl alcohol
- Ethyl alcohol

Do not scrub hard to avoid damaging the display surface.

(6) Solvents other than those above-mentioned may damage the polarizer. Especially, do not use the following. - Water

- Ketone
- Aromatic solvents

Wipe off saliva or water drops immediately, contact with water over a long period of time may cause deformation or color fading. Avoid contacting oil and fats.

(7) Exercise care to minimize corrosion of the electrode. Corrosion of the electrodes is accelerated by water droplets, moisture condensation or a current flow in a high-humidity environment.

(8) Install the LCD Module by using the mounting holes. When mounting the LCD module make sure it is free of twisting, warping and distortion. In particular, do not forcibly pull or bend the I/O cable or the backlight cable.

(9) Do not attempt to disassemble or process the LCD module.

(10) NC terminal should be open. Do not connect anything.

(11) If the logic circuit power is off, do not apply the input signals.

(12) Electro-Static Discharge Control, Since this module uses a CMOS LSI, the same careful attention should be paid to electrostatic discharge as for an ordinary CMOS IC. To prevent destruction of the elements by static electricity, be careful to maintain an optimum work environment.



- Before remove LCM from its packing case or incorporating it into a set, be sure the module and your body have the same electric potential. Be sure to ground the body when handling the LCD modules.

- Tools required for assembling, such as soldering irons, must be properly grounded. make certain the AC power source for the soldering iron does not leak. When using an electric screwdriver to attach LCM, the screwdriver should be of ground potentiality to minimize as much as possible any transmission of electromagnetic waves produced sparks coming from the commutator of the motor.

- To reduce the amount of static electricity generated, do not conduct assembling and other work under dry conditions. To reduce the generation of static electricity be careful that the air in the work is not too dried. A relative humidity of 50%-60% is recommended. As far as possible make the electric potential of your work clothes and that of the work bench the ground potential

- The LCD module is coated with a film to protect the display surface. Exercise care when peeling off this protective film since static electricity may be generated

(13)Since LCM has been assembled and adjusted with a high degree of precision, avoid applying excessive shocks to the module or making any alterations or modifications to it.

- Do not alter, modify or change the shape of the tab on the metal frame.

- Do not make extra holes on the printed circuit board, modify its shape or change the positions of components to be attached.

- Do not damage or modify the pattern writing on the printed circuit board.

- Absolutely do not modify the zebra rubber strip (conductive rubber) or heat seal connector.

- Except for soldering the interface, do not make any alterations or modifications with a soldering iron. - Do not drop, bend or twist LCM.



Handling precaution for LCM

LCM is easy to be damaged.

Please note below and be careful for handling!

Correct handling:



As above picture, please handle with anti-static gloves around LCM edges.

Incorrect handling:

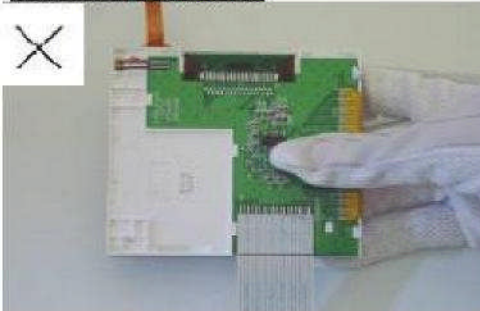

Please don't touch IC directly.

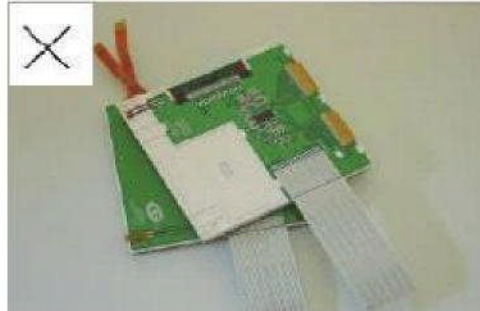

Please don't stack LCM.

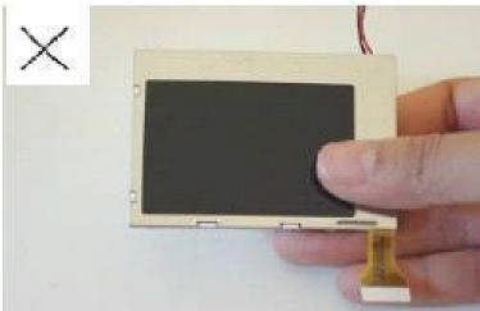

Please don't hold the surface of panel.

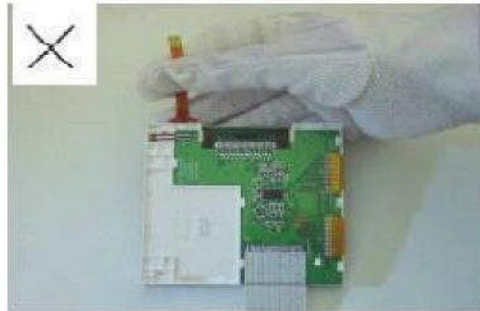

Please don't stretch interface of output, such as FPC cable.



Handling precaution for LCD

LCD is easy to be damaged.

Please note below and be careful for handling!

Correct handling:

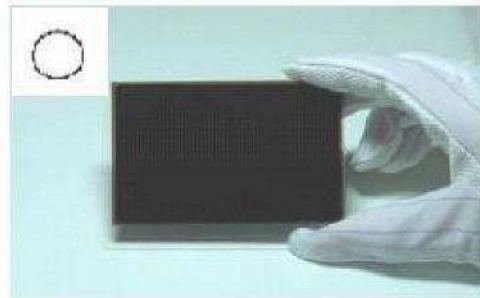

As above photo, please handle with anti-static gloves around LCD edges.

Incorrect handling:



Please don't stack the LCDS.

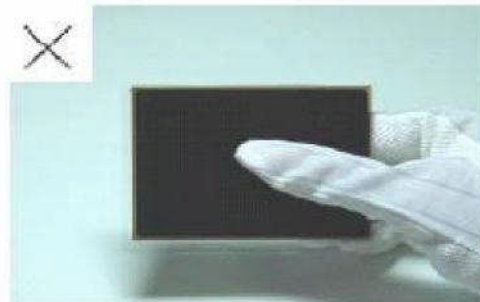

Please don't hold the surface of LCD.



Please don't operate with sharp stick such as pens.

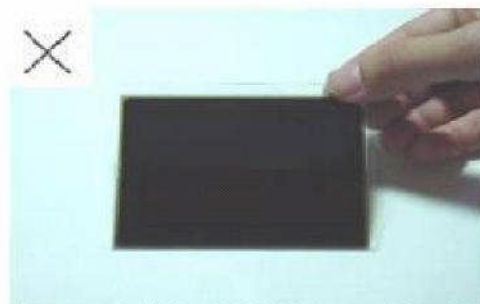

Please don't touch ITO glass without anti-static gloves.



Handling precaution for Touch panel

Touch Panel is easy to be damaged.
Please note below and be careful for handling!

Correct handling:

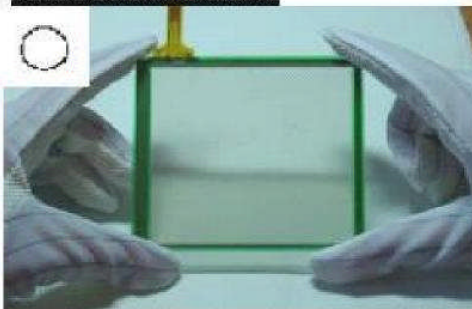

As above picture, please handle with anti-static gloves around touch panel edges.

Incorrect handling:

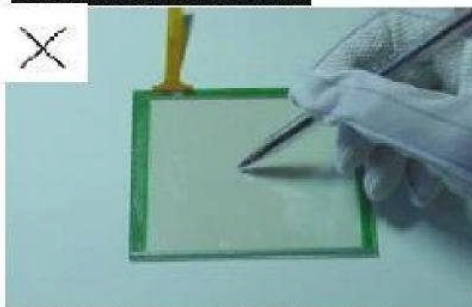

Please don't operate with sharp stick such as pencil.

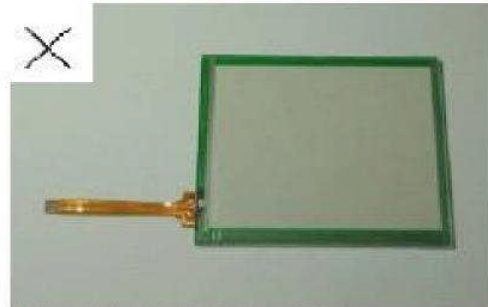

Please keep film surface on upper side.

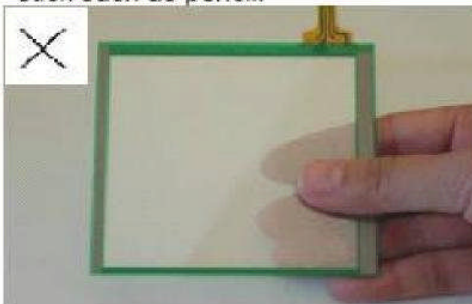

Please don't hold the surface of touch panel.

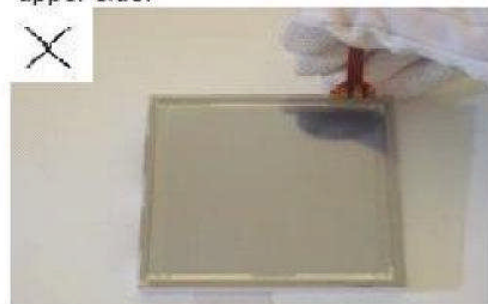

Please don't hold FPC, stretch FPC, or twist FPC.

Storage Precautions

When storing the LCD modules, the following precaution is necessary.

(1) Store them in a sealed polyethylene bag. If properly sealed, there is no need for the dessicant.



(2)Store them in a dark place. Do not expose to sunlight or fluorescent light, keep the temperature between 0°C and 35°C, and keep the relative humidity between 40%RH and 60%RH.

(3)The polarizer surface should not come in contact with any other objects. (We advise you to store them in the anti-static electricity container in which they were shipped.

Others

Liquid crystals solidify under low temperature (below the storage temperature range) leading to defective orientation or the generation of air bubbles (black or white). Air bubbles may also be generated if the module is subject to a low temperature.

If the LCD modules have been operating for a long time showing the same display patterns, the display patterns may remain on the screen as ghost images and a slight contrast irregularity may also appear. A normal operating status can be regained by suspending use for some time. It should be noted that this phenomenon does not adversely affect performance reliability.

To minimize the performance degradation of the LCD modules resulting from destruction caused by static electricity etc., exercise care to avoid holding the following sections when handling the modules.

- Exposed area of the printed circuit board.
- Terminal electrode sections.
-

USING LCD MODULES

Installing LCD Modules

The hole in the printed circuit board is used to fix LCM as shown in the picture below. Attend to the following items when installing the LCM.

(1) Cover the surface with a transparent protective plate to protect the polarizer and LC cell.

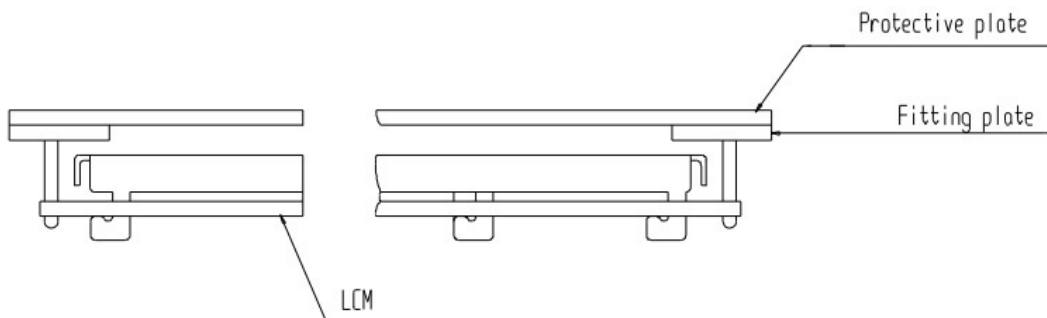

(2) When assembling the LCM into other equipment, the spacer to the bit between the LCM and the fitting plate should have enough height to avoid causing stress to the



module surface, refer to the individual specifications for measurements. The measurement tolerance should be $\pm 0.1\text{mm}$.

Precaution for assemble the module with BTB connector:

Please note the position of the male and female connector position, don't assemble or assemble like the method which the following picture shows

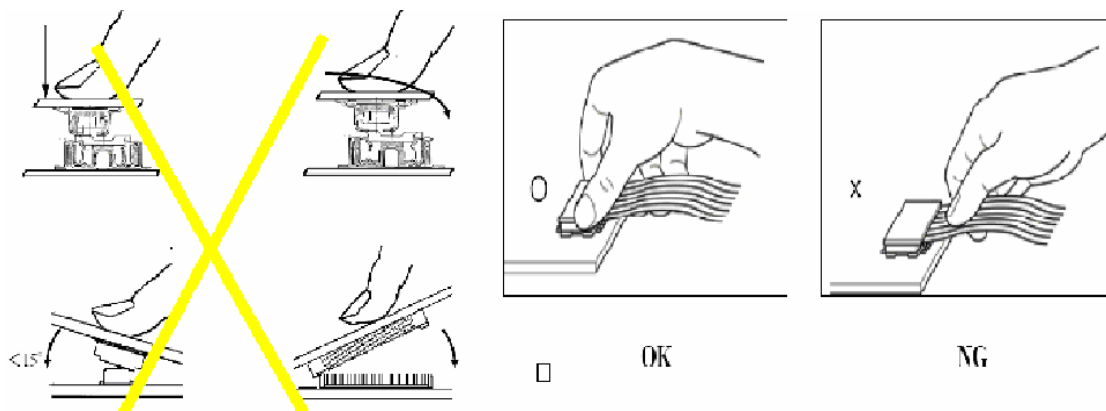

Precaution for soldering the LCM

	Manual soldering	Machine drag soldering	Machine press soldering
No ROHS product	290°C ~350°C. Time : 3-5S.	330°C ~350°C. Speed : 4-8 mm/s.	300°C ~330°C. Time : 3-6S. Press: 0.8~1.2Mpa
ROHS product	340°C ~370°C. Time : 3-5S.	350°C ~370°C. Time : 4- 8 mm/s.	330°C ~360°C. Time : 3-6S. Press: 0.8~1.2Mpa

(1) If soldering flux is used, be sure to remove any remaining flux after finishing to soldering operation. (This does not apply in the case of a non-halogen type of flux.) It is recommended that you protect the LCD surface with a cover during soldering to prevent any damage due to flux spatters.

(2) When soldering the electroluminescent panel and PC board, the panel and board should not be detached more than three times. This maximum number is determined by the temperature and time conditions mentioned above, though there may be some variance depending on the temperature of the soldering iron.



(3) When remove the electroluminescent panel from the PC board, be sure the solder has completely melted, the soldered pad on the PC board could be damaged.

Precautions for Operation

(1) Viewing angle varies with the change of liquid crystal driving voltage (VLCD). Adjust VLCD to show the best contrast.

(2) It is an indispensable condition to drive LCD's within the specified voltage limit since the higher voltage then the limit cause the shorter LCD life. An electrochemical reaction due to direct current causes LCD's undesirable deterioration, so that the use of direct current drive should be avoided.

(3) Response time will be extremely delayed at lower temperature than the operating temperature range and on the other hand at higher temperature LCD's show dark color in them. However those phenomena do not mean malfunction or out of order with LCD's, Which will come back in the specified operating temperature.

(4) If the display area is pushed hard during operation, the display will become abnormal. However, it will return to normal if it is turned off and then back on.

(5) A slight dew depositing on terminals is a cause for electro-chemical reaction resulting in terminal open circuit. Usage under the maximum operating temperature, 50%RH or less is required.

(6) Input each signal after the positive/negative voltage becomes stable.

(7) Please keep the temperature within specified range for use and storage. Polarization degradation, bubble generation or polarizer peel-off may occur with high temperature and high humidity.

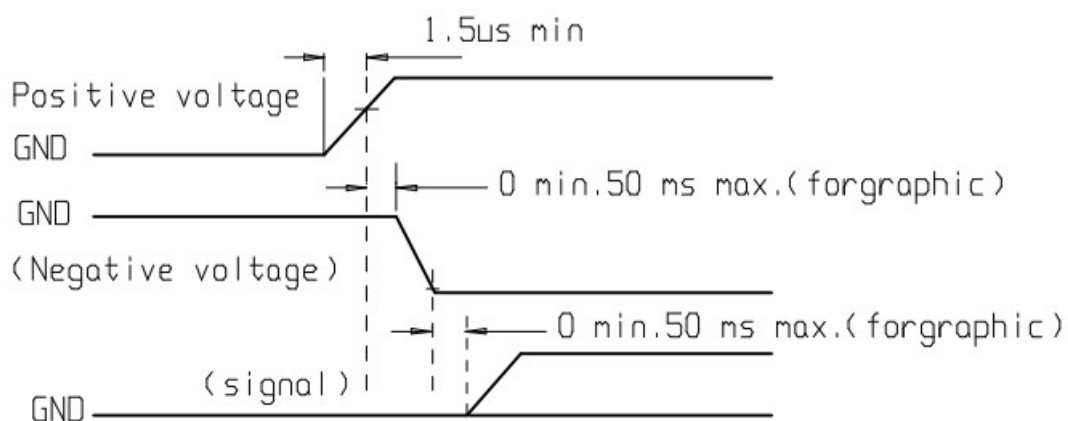



Safety

- (1) It is recommended to crush damaged or unnecessary LCDs into pieces and wash them off with solvents such as acetone and ethanol, which should later be burned.
- (2) If any liquid leaks out of a damaged glass cell and comes in contact with the hands, wash off thoroughly with soap and water.

Limited Warranty

Unless agreed between INANBO and customer, INANBO will replace or repair any of its LCD modules which are found to be functionally defective when inspected in accordance with INANBO LCD acceptance standards (copies available upon request) for a period of one year from date of shipments. Cosmetic/visual defects must be returned to INANBO within 90 days of shipment. Confirmation of such date shall be based on freight documents. The warranty liability of INANBO limited to repair and/or replacement on the terms set forth above. INANBO will not be responsible for any subsequent or consequential events.

Return LCM under warranty

No warranty can be granted if the precautions stated above have been disregarded. The typical examples of violations are :

- Broken LCD glass.
- PCB eyelet is damaged or modified.
- PCB conductors damaged.
- Circuit modified in any way, including addition of components.
- PCB tampered with by grinding, engraving or painting varnish.
- Soldering to or modifying the bezel in any manner.

Module repairs will be invoiced to the customer upon mutual agreement. Modules must be returned with sufficient description of the failures or defects. Any connectors or cable installed by the customer must be removed completely without damaging the PCB eyelet, conductors and terminals.

PACKING SPECIFICATION

TBD



INANBO

INANBO-T32-SSD1289-V11

DOC REV:V11.1

Date:2011-11-12

Page: 23 of 23

PRIOR CONSULT MATTER

- 1.For INanbo standard products, we keep the right to change material, process ... for improving the product property without notice on our customer.
- 2.For OEM products, if any change needed which may affect the product property, we will consult with our customer in advance.
- 3.If you have special requirement about reliability condition, please let us know before you start the test on our samples.