

# M54522P/FP

8-UNIT 400mA DARLINGTON TRANSISTOR ARRAY WITH CLAMP DIODE

## DESCRIPTION

M54522P and M54522FP are eight-circuit Darlington transistor arrays with clamping diodes. The circuits are made of NPN transistors. Both the semiconductor integrated circuits perform high-current driving with extremely low input-current supply.

## FEATURES

- High breakdown voltage ( $BV_{CEO} \geq 40V$ )
- High-current driving ( $I_{c(max)} = 400mA$ )
- With clamping diodes
- Driving available with PMOS IC output
- Wide operating temperature range ( $T_a = -20$  to  $+75^\circ C$ )

## APPLICATION

Drives of relays and printers, digit drives of indication elements (LEDs and lamps), and interfaces between microcomputer output and high-current or high-voltage systems

## FUNCTION

The M54522P and M54522FP each have eight circuits consisting of NPN Darlington transistors. These ICs have resistance of  $20k\Omega$  between input transistor bases and input pins. A spike-killer clamping diode is provided between each output pin (collector) and COM pin. The output transistor emitters are all connected to the GND pin (pin 8).

The collector current is 400mA maximum. Collector-emitter supply voltage is 40V maximum.

The M54522FP is enclosed in a molded small flat package, enabling space-saving design.

## PIN CONFIGURATION

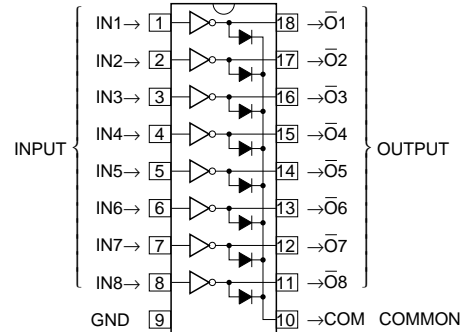

Package type 18P4G(P)

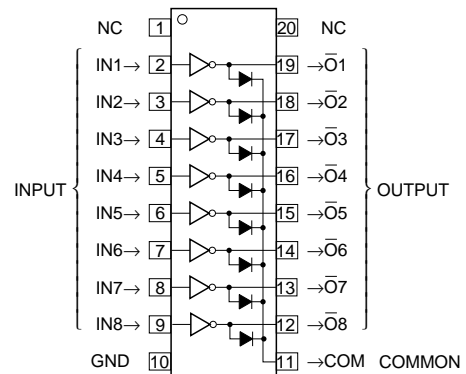

Package type 20P2N-A(FP)

NC : No connection

## CIRCUIT DIAGRAM

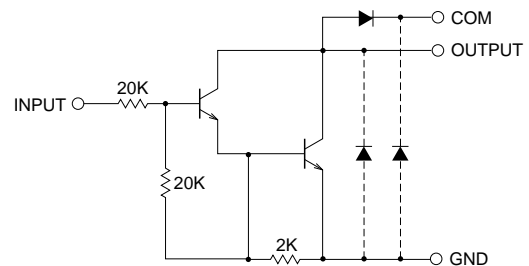

The eight circuits share the COM and GND.  
The diode, indicated with the dotted line, is parasitic, and cannot be used.

Unit :  $\Omega$

# M54522P/FP

## 8-UNIT 400mA DARLINGTON TRANSISTOR ARRAY WITH CLAMP DIODE

### ABSOLUTE MAXIMUM RATINGS (Unless otherwise noted, Ta = -20 ~ +75°C)

Symbol	Parameter	Conditions	Ratings	Unit
V <sub>CEO</sub>	Collector-emitter voltage	Output, H	-0.5 ~ +40	V
I <sub>C</sub>	Collector current	Current per circuit output, L	400	mA
V <sub>I</sub>	Input voltage		-0.5 ~ +40	V
I <sub>F</sub>	Clamping diode forward current		400	mA
V <sub>R</sub>	Clamping diode reverse voltage		40	V
P <sub>d</sub>	Power dissipation	Ta = 25°C, when mounted on board	1.79(P)/1.10(FP)	W
T <sub>opr</sub>	Operating temperature		-20 ~ +75	°C
T <sub>stg</sub>	Storage temperature		-55 ~ +125	°C

### RECOMMENDED OPERATING CONDITIONS (Unless otherwise noted, Ta = -20 ~ +75°C)

Symbol	Parameter	Limits			Unit	
		min	typ	max		
V <sub>o</sub>	Output voltage	0	—	40	V	
I <sub>C</sub>	Collector current (Current per 1 circuit when 8 circuits are coming on simultaneously)	Duty Cycle P : no more than 7% FP : no more than 5%	0	—	400	mA
		Duty Cycle P : no more than 30% FP : no more than 20%	0	—	200	
V <sub>IH</sub>	"H" input voltage	I <sub>C</sub> ≤ 400mA	8	—	30	V
		I <sub>C</sub> ≤ 200mA	4	—		
V <sub>IL</sub>	"L" input voltage		0	—	0.5	V

### ELECTRICAL CHARACTERISTICS (Unless otherwise noted, Ta = -20 ~ +75°C)

Symbol	Parameter	Test conditions	Limits			Unit
			min	typ*	max	
V (BR) CEO	Collector-emitter breakdown voltage	I <sub>CEO</sub> = 100μA	40	—	—	V
V <sub>CE (sat)</sub>	Collector-emitter saturation voltage	V <sub>I</sub> = 8V, I <sub>C</sub> = 400mA	—	1.15	2.4	V
		V <sub>I</sub> = 4V, I <sub>C</sub> = 200mA	—	0.95	1.6	
I <sub>I</sub>	Input current	V <sub>I</sub> = 17V	0.3	0.85	1.8	mA
V <sub>F</sub>	Clamping diode forward voltage	I <sub>F</sub> = 400mA	—	1.5	2.4	V
I <sub>R</sub>	Clamping diode reverse current	V <sub>R</sub> = 40V	—	—	100	μA
h <sub>FE</sub>	DC amplification factor	V <sub>CE</sub> = 4V, I <sub>C</sub> = 300mA, Ta = 25°C	1000	8000	—	—

\* : The typical values are those measured under ambient temperature (Ta) of 25°C. There is no guarantee that these values are obtained under any conditions.

### SWITCHING CHARACTERISTICS (Unless otherwise noted, Ta = 25°C)

Symbol	Parameter	Test conditions	Limits			Unit
			min	typ	max	
t <sub>on</sub>	Turn-on time	C <sub>L</sub> = 15pF (note 1)	—	30	—	ns
t <sub>off</sub>	Turn-off time		—	930	—	ns

# M54522P/FP

## 8-UNIT 400mA DARLINGTON TRANSISTOR ARRAY WITH CLAMP DIODE

### NOTE 1 TEST CIRCUIT

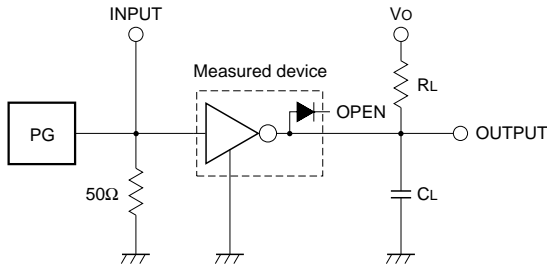

- (1) Pulse generator (PG) characteristics : PRR = 1kHz,  
 $t_w = 10\mu s$ ,  $t_r = 6ns$ ,  $t_f = 6ns$ ,  $Z_o = 50\Omega$   
 $V_{IN} = 0$  to  $8V$
- (2) Input-output conditions :  $R_L = 25\Omega$ ,  $V_o = 10V$
- (3) Electrostatic capacity  $C_L$  includes floating capacitance at connections and input capacitance at probes

### TIMING DIAGRAM

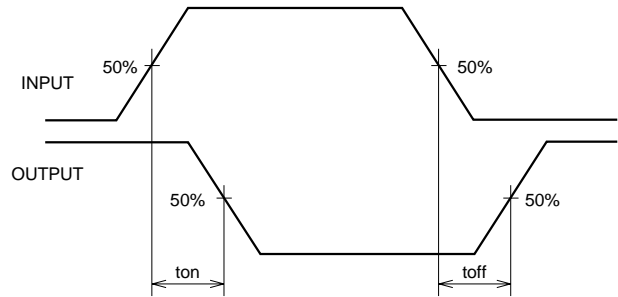

### TYPICAL CHARACTERISTICS

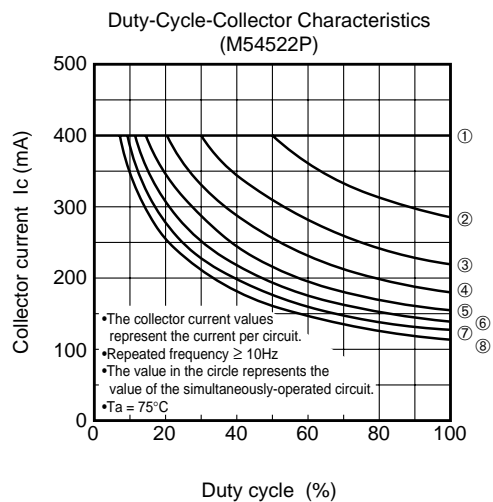
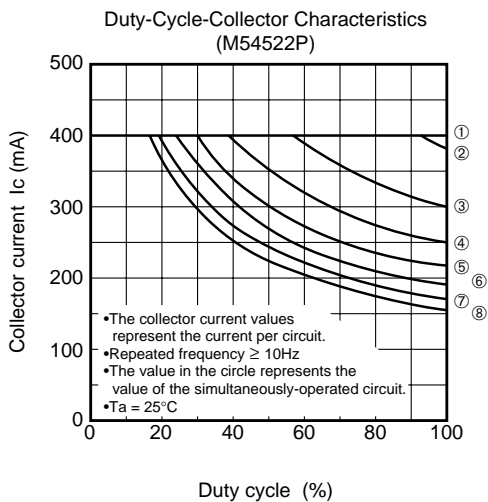
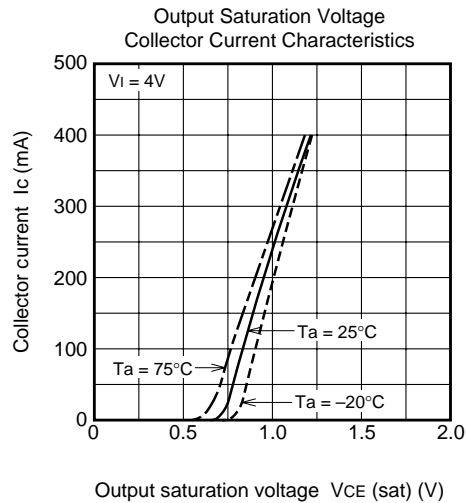
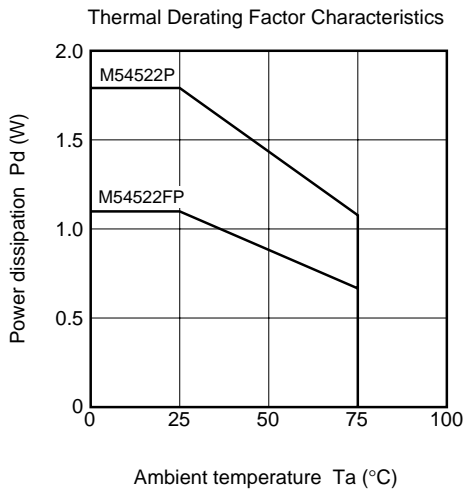

**M54522P/FP**

8-UNIT 400mA DARLINGTON TRANSISTOR ARRAY WITH CLAMP DIODE

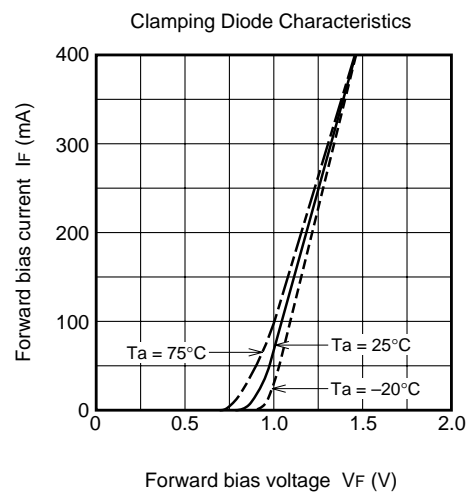
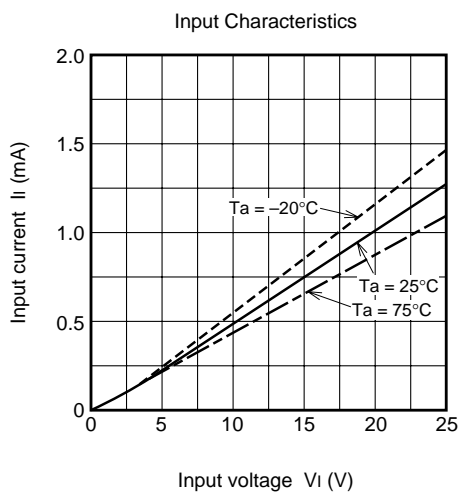
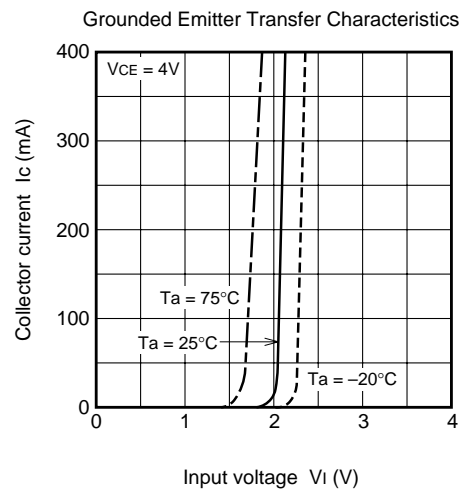
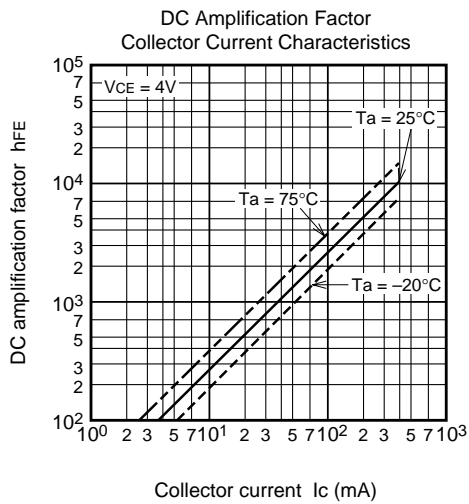
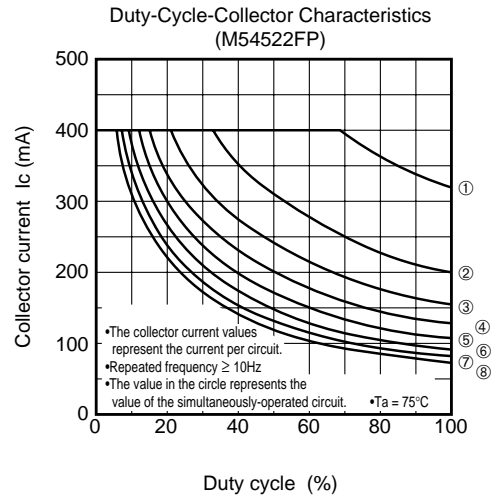
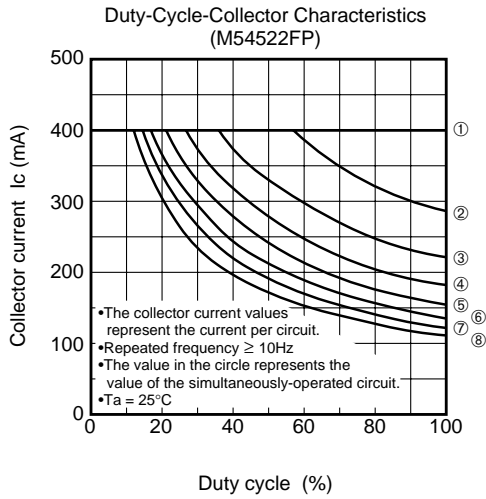

This datasheet has been download from:

[www.datasheetcatalog.com](http://www.datasheetcatalog.com)

Datasheets for electronics components.