



Low Power Voltage Controlled Oscillator Buffer

The MC12147 is intended for applications requiring high frequency signal generation up to 1300 MHz. An external tank circuit is used to determine the desired frequency of operation. The VCO is realized using an emitter-coupled pair topology. The MC12147 can be used with an integrated PLL IC such as the MC12202 1.1 GHz Frequency Synthesizer to realize a complete PLL sub-system. The device is specified to operate over a voltage supply range of 2.7 to 5.5 V. It has a typical current consumption of 13 mA at 3.0 V which makes it attractive for battery operated handheld systems.

DEVICE TO BE PHASED OUT.

NOTE: The MC12147 is NOT suitable as a crystal oscillator.

- Operates Up to 1.3 GHz
- Space-Efficient 8-Pin SOIC or SSOP Package
- Low Power 13 mA Typical @ 3.0 V Operation
- Supply Voltage of 2.7 to 5.5 V
- Typical 900MHz Performance
 - Phase Noise -105 dBc/Hz @ 100 kHz Offset
 - Tuning Voltage Sensitivity of 20 MHz/V
- Output Amplitude Adjustment Capability
- Two High Drive Outputs With a Typical Range from -8.0 to -2.0 dBm

The device has two high frequency outputs which make it attractive for transceiver applications which require both a transmit and receive local oscillator (LO) signal. The outputs Q and QB are available for servicing the receiver IF and transmitter up-converter single-ended. In receiver applications, the outputs can be used together if it is necessary to generate a differential signal for the receiver IF. Because the Q and QB outputs are open collector, terminations to the V_{CC} supply are required for proper operation. Since the outputs are complementary, BOTH outputs must be terminated even if only one is needed. The Q and QB outputs have a nominal drive level of -8dBm to conserve power. If addition signal amplitude is needed, a level adjustment pin (CNTL) is available, which when tied to ground, boosts the nominal output levels to -2.0 dBm.

External components required for the MC12147 are: (1) tank circuit (LC network); (2) Inductor/capacitor to provide the termination for the open collector outputs; and (3) adequate supply voltage bypassing. The tank circuit consists of a high-Q inductor and varactor components. The preferred tank configuration allows the user to tune the VCO across the full supply range. VCO performance such as center frequency, tuning voltage sensitivity, and noise characteristics are dependent on the particular components and configuration of the VCO tank circuit.

PIN NAMES

Pin	Function
V _{CC}	Power Supply
CNTL	Amplitude Control for Q, QB Output Pair
TANK	Tank Circuit Input
V _{REF}	Bias Voltage Output
QB	Open Collector Output
GND	Ground
Q	Open Collector Output

MC12147

LOW POWER VOLTAGE CONTROLLED OSCILLATOR BUFFER

SEMICONDUCTOR TECHNICAL DATA



D SUFFIX
PLASTIC PACKAGE
CASE 751
(SO-8)

PIN CONNECTIONS

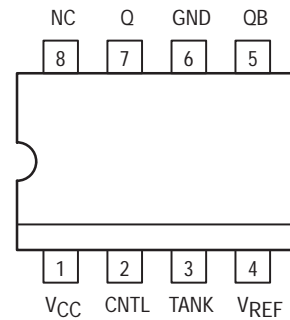

(Top View)

ORDERING INFORMATION

Device	Operating Temperature Range	Package
MC12147D	T _A = -40 to 85°C	SO-8

Freescale Semiconductor, Inc. ARCHIVE INFORMATION

ARCHIVE INFORMATION

MAXIMUM RATINGS (Note 1)

Parameter	Symbol	Value	Unit
Power Supply Voltage, Pin 1	V_{CC}	-0.5 to +7.0	V
Operating Temperature Range	T_A	-40 to +85	°C
Storage Temperature Range	T_{STG}	-65 to +150	°C
Maximum Output Current, Pin 5,7	I_O	12	mA

- NOTES:** 1. Maximum Ratings are those values beyond which damage to the device may occur. Functional operation should be restricted to the Recommended Operating Conditions.
 2. ESD data available upon request.

ELECTRICAL CHARACTERISTICS ($V_{CC} = 2.7$ to 5.5 VDC, $T_A = -40$ to 85°C , unless otherwise noted.)

Characteristic	Symbol	Min	Typ	Max	Unit
Supply Current (CNTL=GND) $V_{CC} = 3.3$ V $V_{CC} = 5.5$ V	I_{CC}	-	14.0 23.5	18 28	mA
Supply Current (CNTL=OPEN) $V_{CC} = 3.3$ V $V_{CC} = 5.5$ V	I_{CC}	-	8 13	13.0 22.5	mA
Output Amplitude (Pin 5 & 7) [Note 1] 50Ω to V_{CC} $V_{CC} = 2.7$ V	V_{OH} , V_{OL}	2.6 2.1	2.7 2.3	- 2.4	V
Output Amplitude (Pin 5 & 7) [Note 1] 50Ω to V_{CC} $V_{CC} = 5.5$ V	V_{OH} , V_{OL}	5.4 4.8	5.5 5.0	- 5.1	V
Tuning Voltage Sensitivity [Notes 2 and 3]	T_{stg}	-	20	-	MHz/V
Frequency of Operation	F_C	100	-	1300	MHz
CSR at 10 kHz Offset, 1.0 Hz BW [Notes 2 and 3]	$L(f)$	-	-85	-	dBc/Hz
CSR at 100 kHz Offset, 1.0 Hz BW [Notes 2 and 3]	$L(f)$	-	-105	-	dBc/Hz
Frequency Stability [Notes 2 and 3] Supply Drift	F_{sts}	-	0.8	-	MHz/V
Thermal Drift	f_{stt}	-	50	-	KHz/°C

- NOTES:** 1. CNTL pin tied to ground.
 2. Actual performance depends on tank components selected.
 3. See Figure 12, 750 MHz tank.
 4. $T = 25^\circ\text{C}$, $V_{CC} = 5.0$ V $\pm 10\%$

OPERATIONAL CHARACTERISTICS

A simplified schematic of the MC12147 is found in Figure 1. The oscillator incorporates positive feedback by coupling the base of transistor Q2 to the collector of transistor Q1. In order to minimize interaction between the VCO outputs and the oscillator tank transistor pair, a buffer is incorporated into the circuit. This differential buffer is realized by the Q3 and Q4 transistor pair. The differential buffer drives the gate which contains the primary open collector outputs, Q and QB. The output is actually a current which has been set by an internal bias driver to a nominal current of 4mA. Additional circuitry is incorporated into the tail of the current source which allows the current source to be increased to approximately 10mA. This is accommodated by the addition of a resistor which is brought out to the CNTL pin. When this pin is tied to ground, the additional current is sourced through the current source thus increasing the output amplitude of the Q/QB output pair. If less than 10 mA of current is needed, a resistor can be added to ground which reduces the amount of current.

be incorporated into the V_{CC} line without compromising the tuning range of the VCO. With the AC-coupled tank configuration, the V_{tune} voltage can be greater than the V_{CC} voltage supplied to the device.

There are four main areas that the user directly influences the performance of the VCO. These include Tank Design, Output Termination Selection, Power Supply Decoupling, and Circuit Board Layout/Grounding.

The design of the tank circuit is critical to the proper operation of the VCO. This tank circuit directly impacts the main VCO operating characteristics:

- 1) Frequency of Operation
- 2) Tuning Sensitivity
- 3) Voltage Supply Pushing
- 4) Phase Noise Performance

The tank circuit, in its simplest form, is realized as an LC circuit which determines the VCO operating frequency. This is described in Equation 1.

$$f_0 = \frac{1}{2\pi \sqrt{LC}} \quad \text{Equation 1}$$

In the practical case, the capacitor is replaced with a varactor diode whose capacitance changes with the voltage applied, thus changing the resonant frequency at which the VCO tank operates. The capacitive component in Equation 1 also needs to include the input capacitance of the device and other circuit and parasitic elements. Typically, the inductor is realized as a surface mount chip or a wound-coil. In addition, the lead inductance and board inductance and capacitance also have an impact on the final operating point.

APPLICATION INFORMATION

Figure 2 illustrates the external components necessary for the proper operation of the VCO buffer. The tank circuit configuration in this figure allows the VCO to be tuned across the full operating voltage of the power supply. This is very important in 3V applications where it is desirable to utilize as much of the operating supply range as possible so as to minimize the VCO sensitivity (MHz/V). In most situations, it is desirable to keep the sensitivity low so the circuit will be less susceptible to external noise influences. An additional benefit to this configuration is that additional regulation/ filtering can

Figure 1. Simplified Schematic

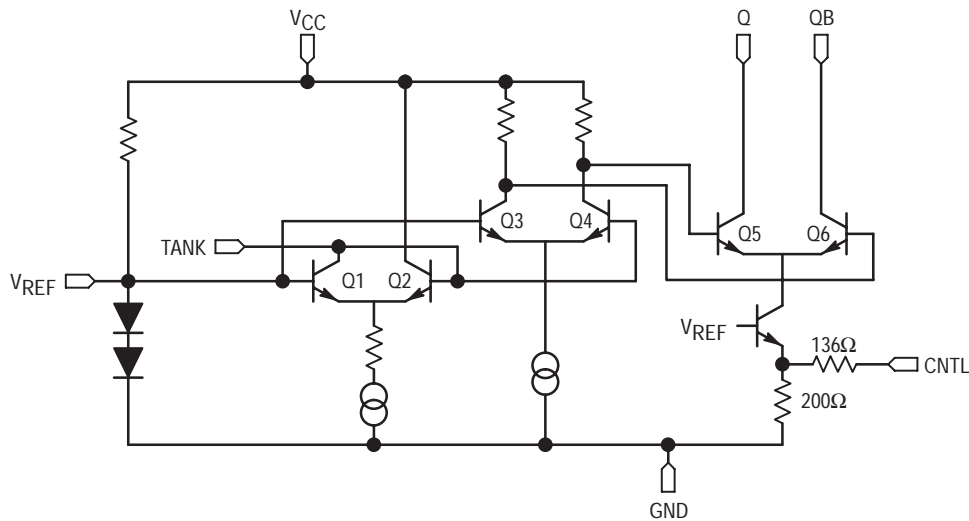

Freescale Semiconductor, Inc. ARCHIVE INFORMATION

ARCHIVE INFORMATION

Figure 2. MC12147 Typical External Component Connections

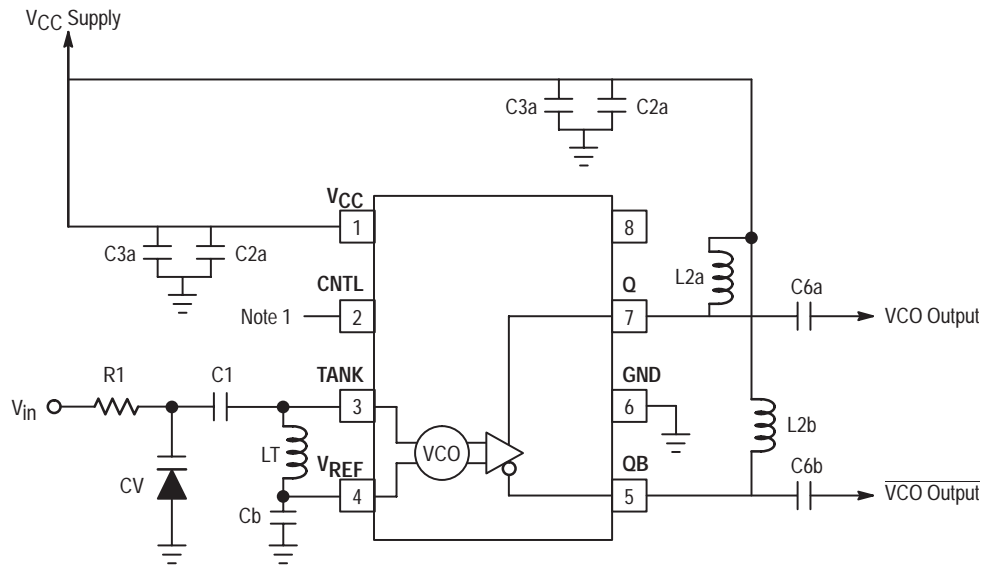

1. This input can be left open, tied to ground, or tied with a resistor to ground, depending on the desired output amplitude needed at the Q and QB output pair.
2. Typical values for R1 range from 5.0 kΩ to 10 kΩ.

A simplified linear approximation of the device, package, and typical board parasitics has been developed to aid the designer in selecting the proper tank circuit values. All the parasitic contributions have been lumped into a parasitic capacitive component and a parasitic inductive component. While this is not entirely accurate, it gives the designer a solid starting point for selecting the tank components.

Below are the parameters used in the model.

- Cp Parasitic Capacitance
- Lp Parasitic Inductance
- LT Inductance of Coil
- C1 Coupling Capacitor Value
- Cb Capacitor for decoupling the Bias Pin
- CV Varactor Diode Capacitance (Variable)

The values for these components are substituted into the following equations:

$$C_i = \frac{C_1 \times CV}{C_1 + CV} + C_p \quad \text{Equation 2}$$

$$C = \frac{C_i \times C_b}{C_i + C_b} \quad \text{Equation 3}$$

$$L = L_p + L_T \quad \text{Equation 4}$$

From Figure 2, it can be seen that the varactor capacitance (CV) is in series with the coupling capacitor (C1). This is calculated in Equation 2. For analysis purposes, the parasitic capacitances (CP) are treated as a lumped element and placed in parallel with the series combination of C1 and CV. This compound capacitance (Ci) is in series with the bias capacitor (Cb) which is calculated in Equation 3. The influences of the various capacitances; C1, CP, and Cb, impact the design by reducing the variable capacitance effects of the varactor which controls the tank resonant frequency and tuning range.

Now the results calculated from Equation 2, Equation 3 and Equation 4 can be substituted into Equation 1 to calculate the actual frequency of the tank.

To aid in analysis, it is recommended that the designer use a simple spreadsheet based on Equation 1 through Equation 4 to calculate the frequency of operation for various varactor/inductor selections before determining the initial starting condition for the tank.

The two main components at the heart of the tank are the inductor (LT) and the varactor diode (CV). The capacitance of a varactor diode junction changes with the amount of reverse bias voltage applied across the two terminals. This is the element which actually “tunes” the VCO. One characteristic of the varactor is the tuning ratio which is the ratio of the capacitance at specified minimum and maximum voltage points. For characterizing the MC12147, a Matsushita (Panasonic) varactor – MA393 was selected. This device has a typical capacitance of 11 pF at 1V and 3.7 pF at 4V and the C–V characteristic is fairly linear over that range. Similar performance was also achieved with Loral varactors. A multi-layer chip inductor was used to realize the LT component. These inductors had typical Q values in the 35–50 range for frequencies between 500 and 1000MHz.

Note: There are many suppliers of high performance varactors and inductors an Motorola can not recommend one vendor over another.

The Q (quality factor) of the components in the tank circuit has a direct impact on the resulting phase noise of the oscillator. In general, the higher the Q, the lower the phase noise of the resulting oscillator. In addition to the LT and CV components, only high quality surface-mount RF chip capacitors should be used in the tank circuit. These capacitors should have very low dielectric loss (high-Q). At a minimum, the capacitors selected should be operating 100 MHz below their series resonance point. As the desired frequency of operation increases, the values of the C1 and Cb capacitors will decrease since the series resonance point

is a function of the capacitance value. To simplify the selection of C1 and Cb, a table has been constructed based on the intended operating frequency to provide recommended starting points. These may need to be altered depending on the value of the varactor selected.

Frequency	C1	Cb
200 – 500 MHz	47 pF	47 pF
500 – 900 MHz	5.1 pF	15 pF
900 – 1200 MHz	2.7 pF	15 pF

The value of the Cb capacitor influences the VCO supply pushing. To minimize pushing, the Cb capacitor should be kept small. Since C1 is in series with the varactor, there is a strong relationship between these two components which influences the VCO sensitivity. Increasing the value of C1 tends to increase the sensitivity of the VCO.

The parasitic contributions Lp and Cp are related to the MC12147 as well as parasitics associated with the layout, tank components, and board material selected. The input capacitance of the device, bond pad, the wire bond, package/lead capacitance, wire bond inductance, lead inductance, printed circuit board layout, board dielectric, and proximity to the ground plane all have an impact on these parasitics. For example, if the ground plane is located directly below the tank components, a parasitic capacitor will be formed consisting of the solder pad, metal traces, board dielectric material, and the ground plane. The test fixture used for characterizing the device consisted of a two sided copper clad board with ground plane on the back. Nominal values were determined by selecting a varactor and characterizing the device with a number of different tank/frequency combinations and then performing a curve fit with the data to determine values for Lp and Cp. The nominal values for the parasitic effects are seen below:

Parasitic Capacitance	Cp	4.2 pF
Parasitic Inductance	Lp	2.2 nH

These values will vary based on the users unique circuit board configuration.

Basic Guidelines:

1. Select a varactor with high Q and a reasonable capacitance versus voltage slope for the desired frequency range.
2. Select the value of Cb and C1 from the table above .
3. Calculate a value of inductance (L) which will result in achieving the desired center frequency. Note that L includes both LT and Lp.
4. Adjust the value of C1 to achieve the proper VCO sensitivity.
5. Re-adjust value of L to center VCO.
6. Prototype VCO design using selected components. It is important to use similar construction techniques and materials, board thickness, layout, ground plane spacing as intended for the final product.
7. Characterize tuning curve over the voltage operation conditions.
8. Adjust, as necessary, component values – L,C1, and Cb to compensate for parasitic board effects.
9. Evaluate over temperature and voltage limits.

10. Perform worst case analysis of tank component variation to insure proper VCO operation over full temperature and voltage range and make any adjustments as needed.

Outputs Q and QB are open collector outputs and need a inductor to VCC to provide the voltage bias to the output transistor. In most applications, dc-blocking capacitors are placed in series with the output to remove the dc component before interfacing to other circuitry. These outputs are complementary and should have identical inductor values for each output. This will minimize switching noise on the VCC supply caused by the outputs switching. It is important that both outputs be terminated, even if only one of the outputs is used in the application.

Referring to Figure 2, the recommended value for L2a and L2b should be 47 nH and the inductor components resonance should be at least 300 MHz greater than the maximum operating frequency. For operation above 1100 MHz, it may be necessary to reduce that inductor value to 33 nH. The recommended value for the coupling capacitors C6a, C6b, and C7 is 47 pF. Figure 2 also includes decoupling capacitors for the supply line as well as decoupling for the output inductors. Good RF decoupling practices should be used with a series of capacitors starting with high quality 100 pF chip capacitors close to the device. A typical layout is shown below in Figure 3.

The output amplitude of the Q and QB can be adjusted using the CNTL pin. Referring to Figure 1, if the CNTL pin is connected to ground, additional current will flow through the current source. When the pin is left open, the nominal current flowing through the outputs is 4 mA. When the pin is grounded, the current increases to a nominal value of 10 mA. So if a 50 ohm resistor was connected between the outputs and VCC, the output amplitude would change from 200 mV pp to 500 mV pp with an additional current drain for the device of 6 mA. To select a value between 4 and 10 mA, an external resistor can be added to ground. The equation below is used to calculate the current.

$$I_{out(nom)} = \frac{(200 + 136 + R_{ext}) \times 0.8V}{200 \times (136 + R_{ext})}$$

Figure 4 through Figure 13 illustrate typical performance achieved with the MC12147. The curves illustrate the tuning curve, supply pushing characteristics, output power, current drain, output spectrum, and phase noise performance. In most cases, data is present for both a 750 MHz and 1200 MHz tank design. The table below illustrates the component values used in the designs.

Component	750MHz Tank	1200MHz Tank	Units
R1	5000	5000	Ω
C1	5.1	2.7	pF
LT	4.7	1.8	nH
CV	3.7 @ 1.0 V 11 @ 4.0 V	3.7 @ 1.0 V 11 @ 4.0 V	pF
Cb	100*	15	pF
C6, C7	47	33	pF
L2	47	47	nH

* The value of Cb should be reduced to minimize pushing.

Figure 3. MC12147 Typical Layout
(Not to Scale)

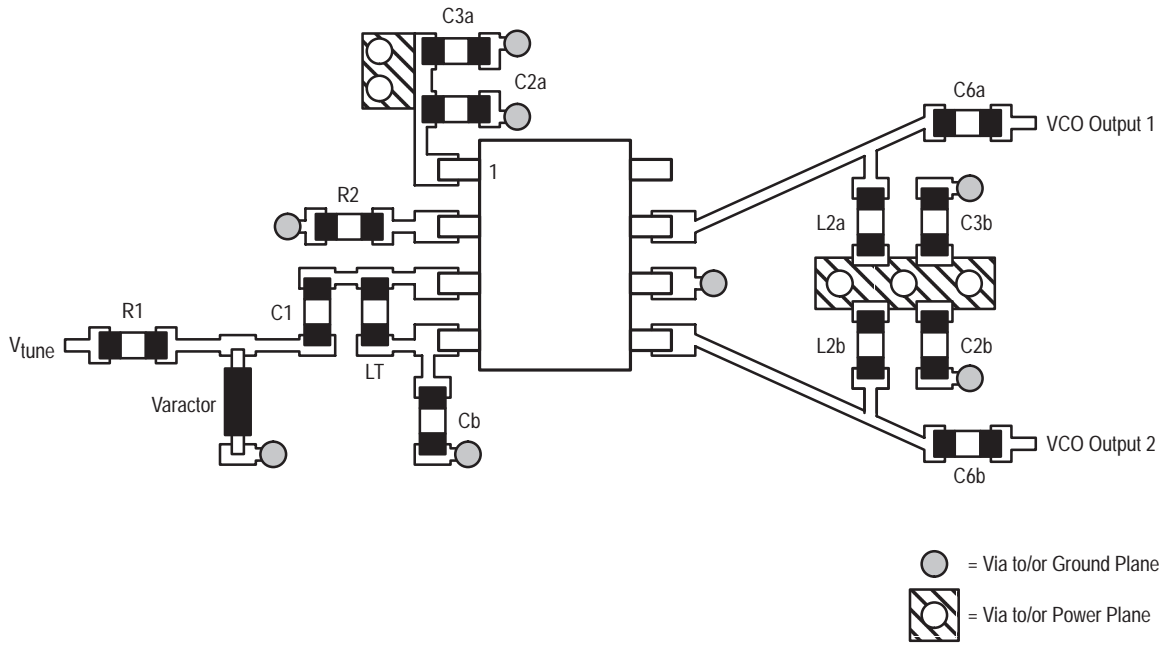

Freescale Semiconductor, Inc.
ARCHIVE INFORMATION

ARCHIVE INFORMATION

Figure 4. Typical VCO Tuning Curve, 750 MHz Tank

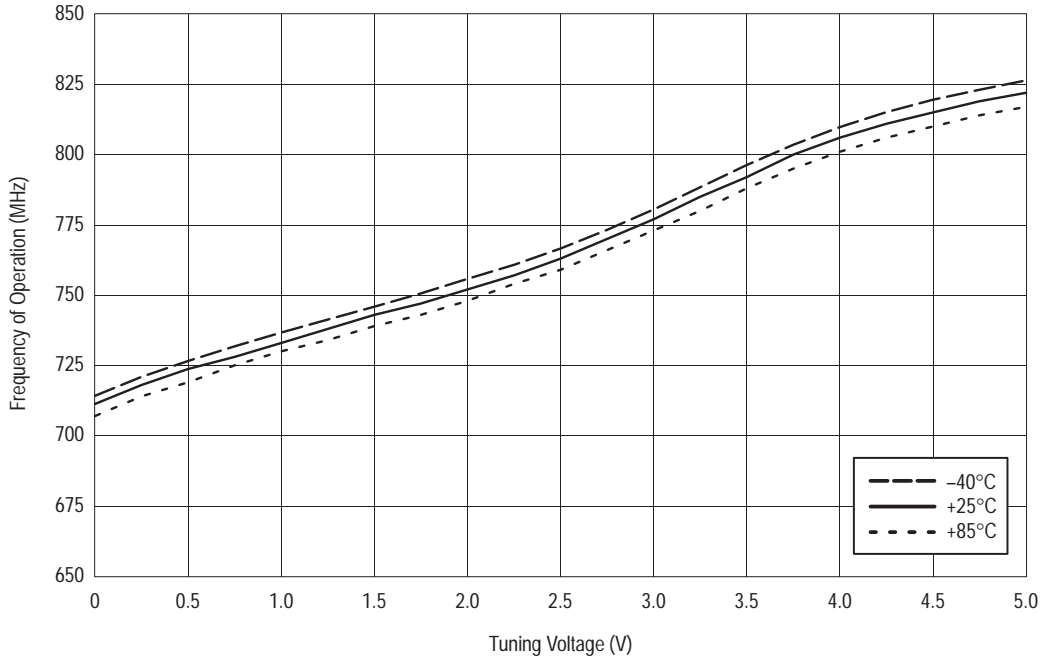
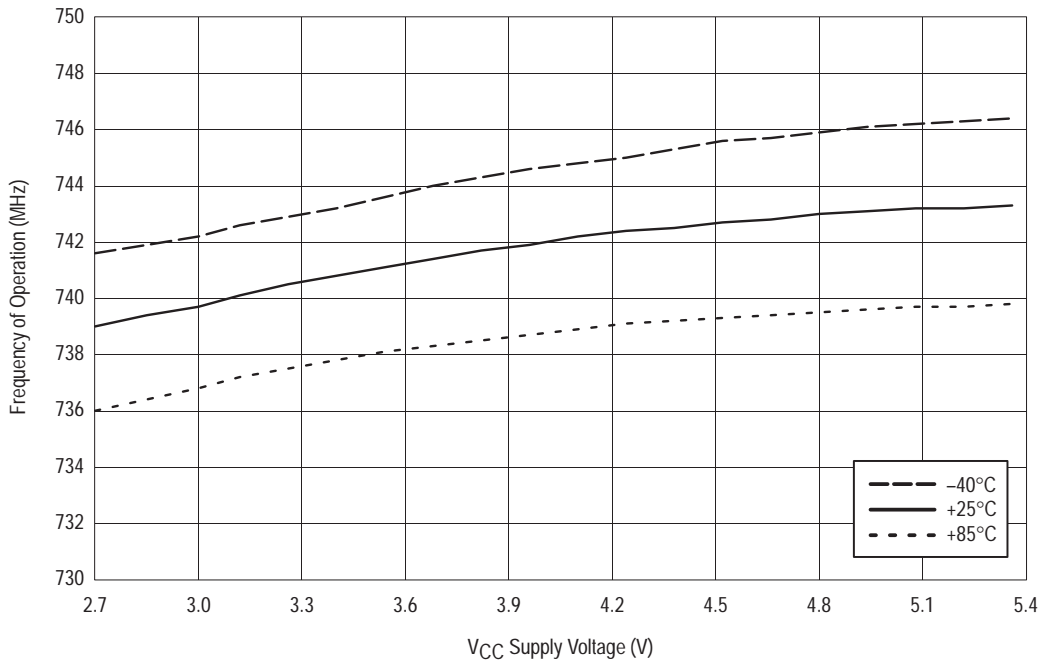

Figure 5. Typical Supply Pushing, 750MHz Tank



Freescale Semiconductor, Inc. ARCHIVE INFORMATION

ARCHIVE INFORMATION

Figure 6. Typical Q/QB Output Power versus Supply, 750 MHz Tank

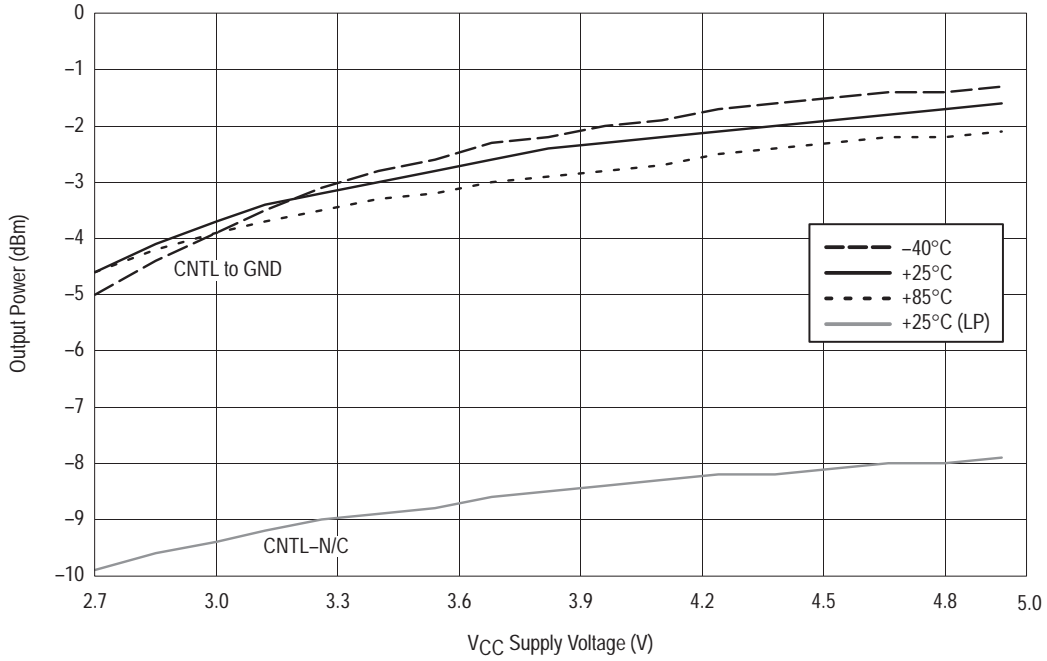
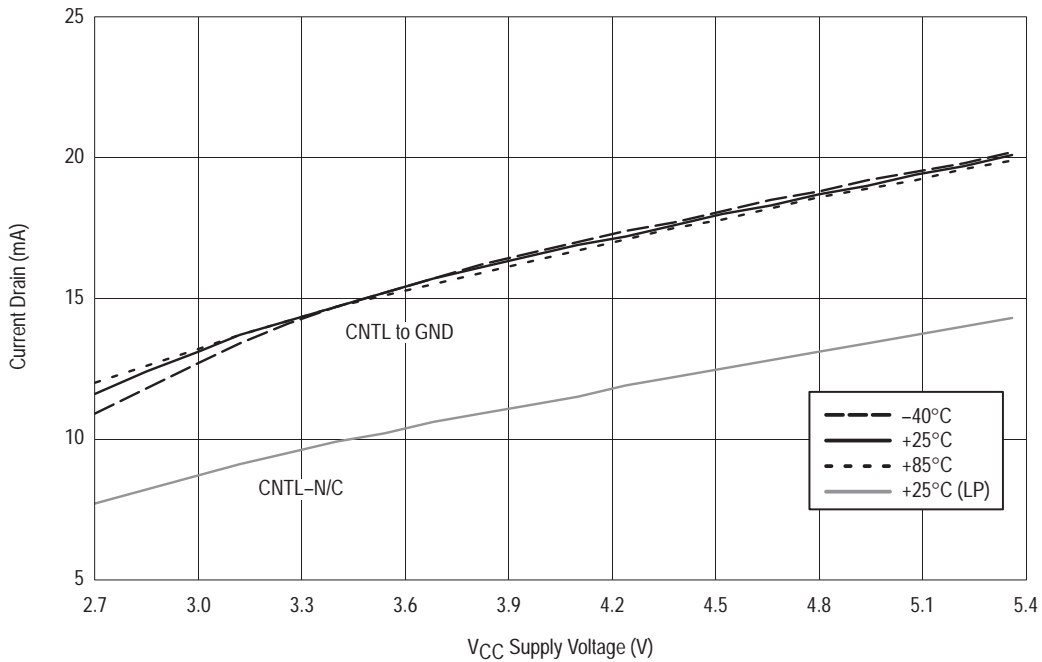

Figure 7. Typical Current Drain versus Supply, 750 MHz Tank



Freescale Semiconductor, Inc. ARCHIVE INFORMATION

ARCHIVE INFORMATION

Figure 8. Typical VCO Tuning Curve, 1200 MHz Tank
($V_{CC} = 5.0\text{ V}$)

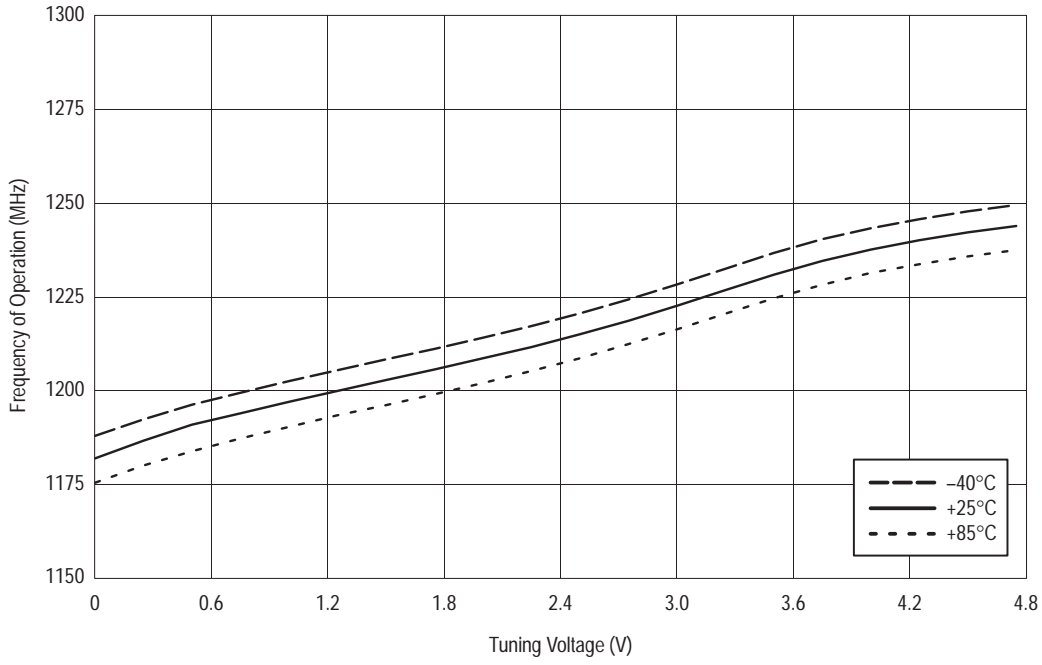
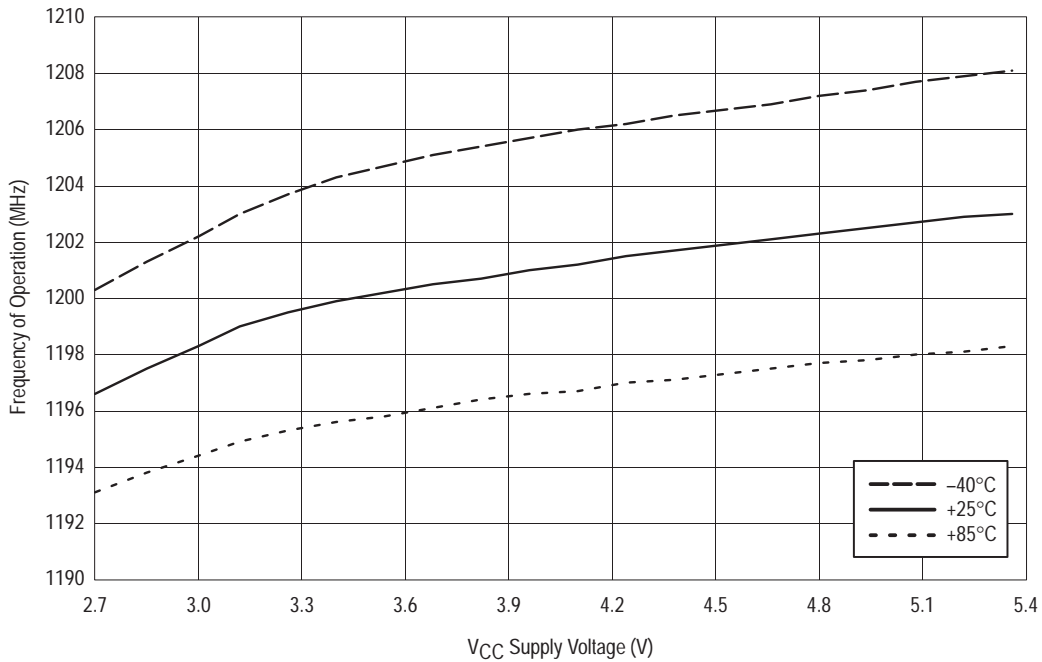

Figure 9. Typical Supply Pushing, 1200 MHz Tank



Freescale Semiconductor, Inc. ARCHIVE INFORMATION

ARCHIVE INFORMATION

Figure 10. Q/QB Output Power versus Supply, 1200 MHz Tank

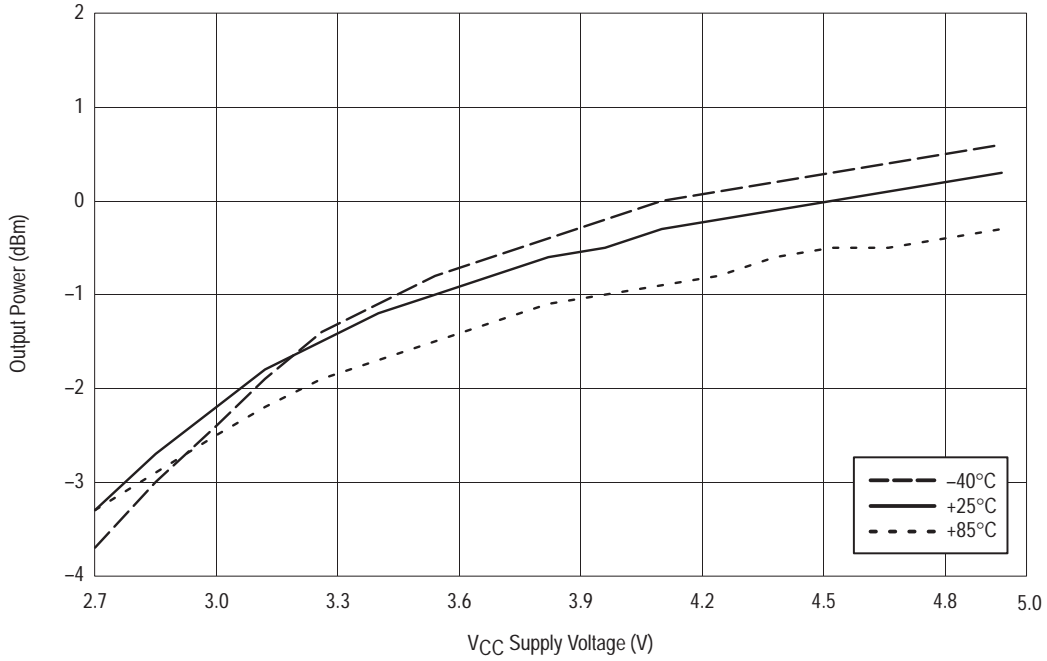
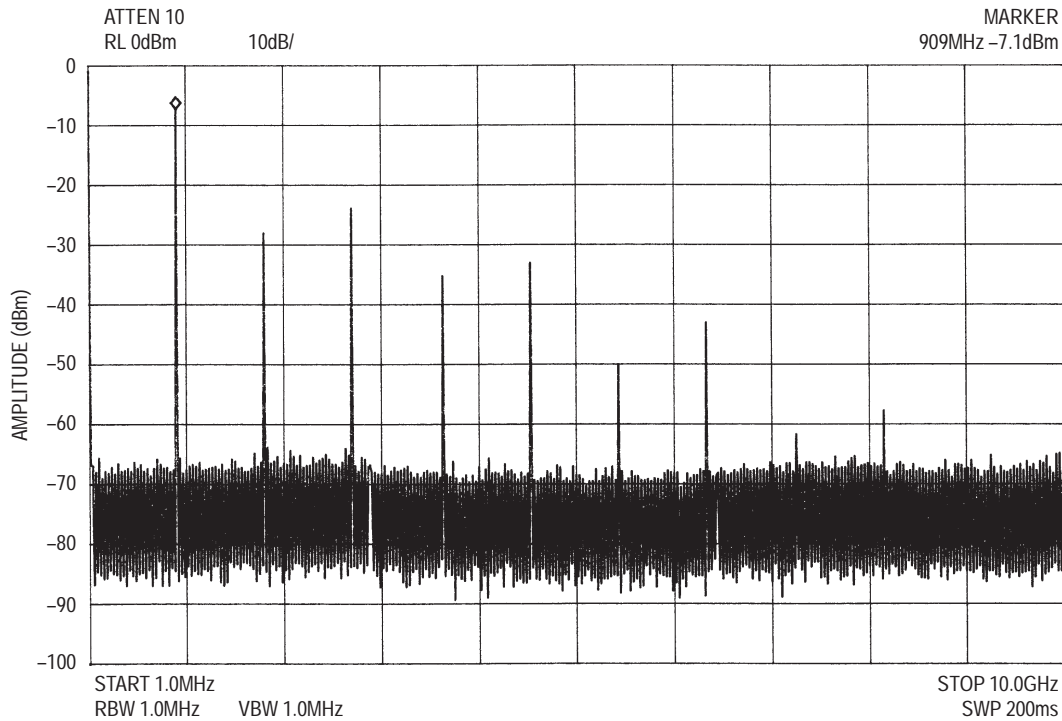

Figure 11. Typical VCO Output Spectrum



Freescale Semiconductor, Inc. ARCHIVE INFORMATION

ARCHIVE INFORMATION

Figure 12. Typical Phase Noise Plot, 750 MHz Tank

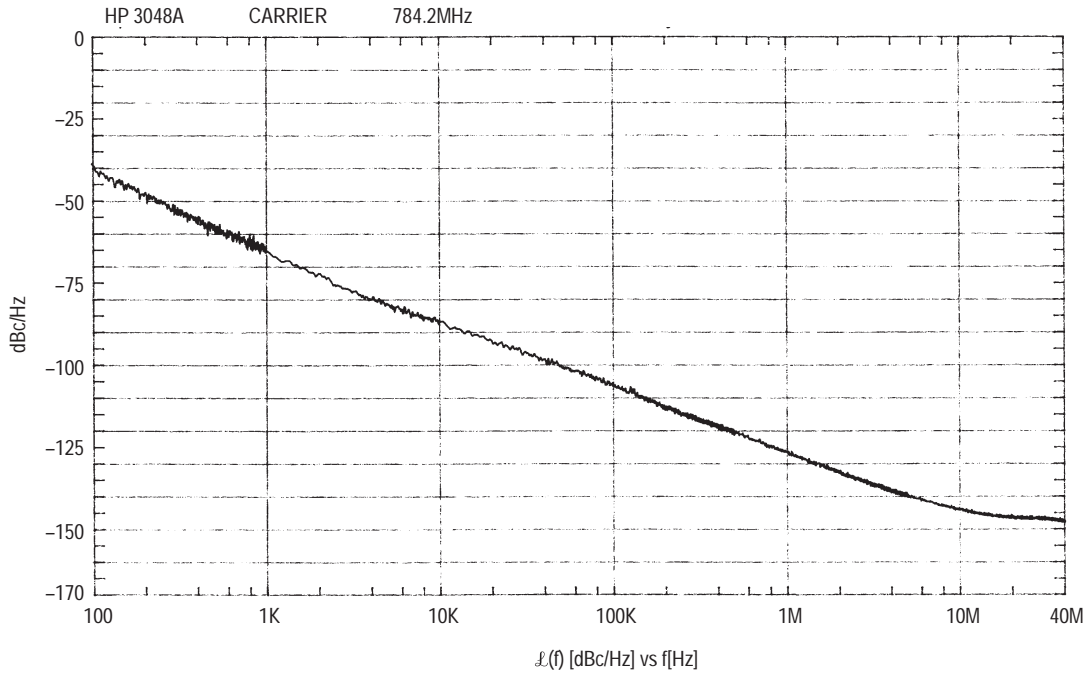
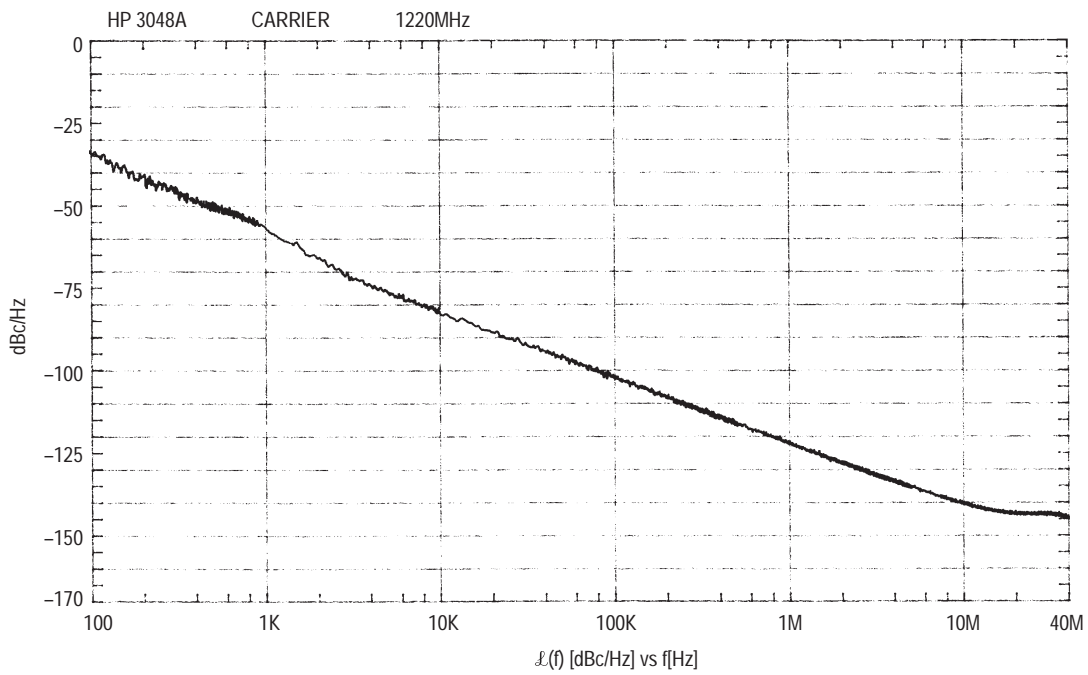
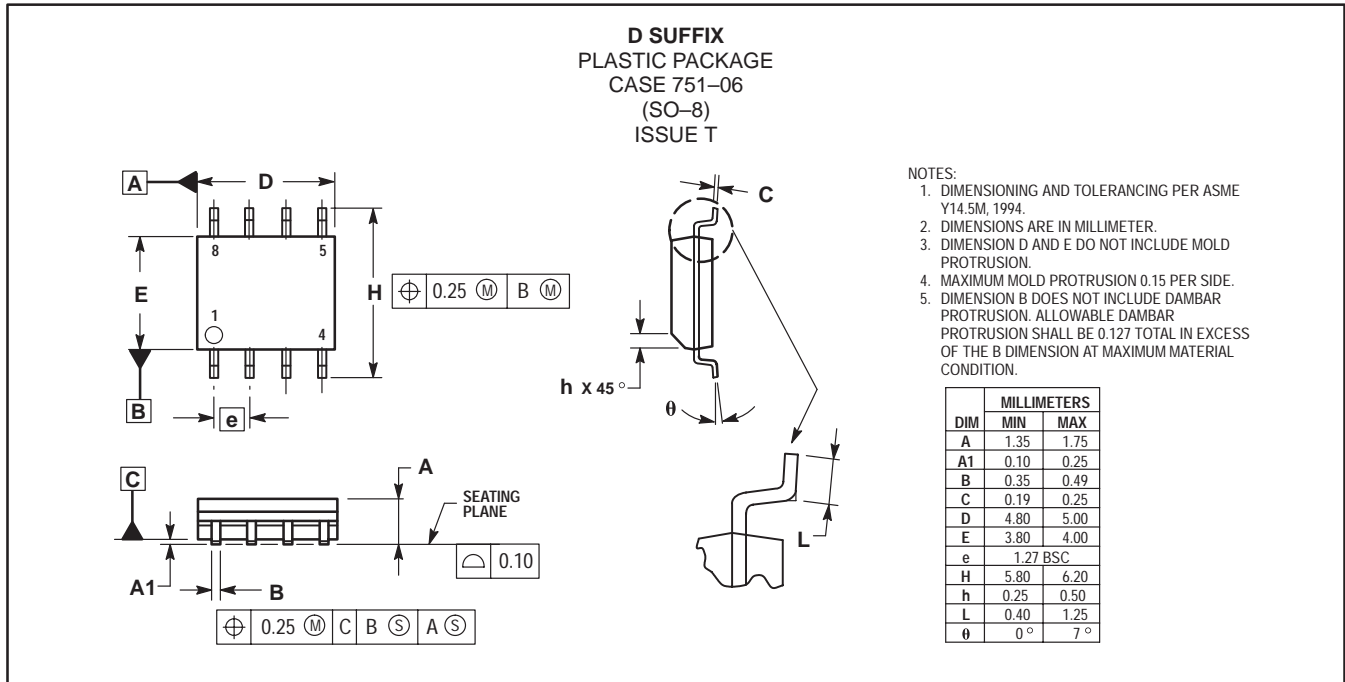

Figure 13. Typical Phase Noise Plot, 1200 MHz Tank



OUTLINE DIMENSIONS



Freescale Semiconductor, Inc. ARCHIVE INFORMATION

ARCHIVE INFORMATION

Motorola reserves the right to make changes without further notice to any products herein. Motorola makes no warranty, representation or guarantee regarding the suitability of its products for any particular purpose, nor does Motorola assume any liability arising out of the application or use of any product or circuit, and specifically disclaims any and all liability, including without limitation consequential or incidental damages. "Typical" parameters which may be provided in Motorola data sheets and/or specifications can and do vary in different applications and actual performance may vary over time. All operating parameters, including "Typicals" must be validated for each customer application by customer's technical experts. Motorola does not convey any license under its patent rights nor the rights of others. Motorola products are not designed, intended, or authorized for use as components in systems intended for surgical implant into the body, or other applications intended to support or sustain life, or for any other application in which the failure of the Motorola product could create a situation where personal injury or death may occur. Should Buyer purchase or use Motorola products for any such unintended or unauthorized application, Buyer shall indemnify and hold Motorola and its officers, employees, subsidiaries, affiliates, and distributors harmless against all claims, costs, damages, and expenses, and reasonable attorney fees arising out of, directly or indirectly, any claim of personal injury or death associated with such unintended or unauthorized use, even if such claim alleges that Motorola was negligent regarding the design or manufacture of the part. Motorola and are registered trademarks of Motorola, Inc. Motorola, Inc. is an Equal Opportunity/Affirmative Action Employer.

Mfax is a trademark of Motorola, Inc.

How to reach us:

USA/EUROPE/Locations Not Listed: Motorola Literature Distribution;
 P.O. Box 5405, Denver, Colorado 80217. 1-303-675-2140 or 1-800-441-2447

JAPAN: Motorola Japan Ltd.; SPD, Strategic Planning Office, 141,
 4-32-1 Nishi-Gotanda, Shinagawa-ku, Tokyo, Japan. 81-3-5487-8488

Customer Focus Center: 1-800-521-6274

Mfax™: RMFAX0@email.sps.mot.com – TOUCHTONE 1-602-244-6609
 Motorola Fax Back System – US & Canada ONLY 1-800-774-1848
 – http://sps.motorola.com/mfax/

ASIA/PACIFIC: Motorola Semiconductors H.K. Ltd.; Silicon Harbour Centre,
 2, Dai King Street, Tai Po Industrial Estate, Tai Po, N.T., Hong Kong.
 852-26668334

HOME PAGE: <http://motorola.com/sps/>



For More Information On This Product,
 Go to: www.freescale.com