



## TURBOSWITCH™ ULTRA-FAST HIGH VOLTAGE DIODE

### MAIN PRODUCT CHARACTERISTICS

$I_{F(AV)}$	2A
$V_{RRM}$	1200V
$t_{rr}$ (typ)	65ns
$V_F$ (max)	1.5V

www.DataSheet4U.com

### FEATURES AND BENEFITS

- SPECIFIC TO THE FOLLOWING OPERATIONS: SNUBBING OR CLAMPING, DEMAGNETIZATION AND RECTIFICATION
- ULTRA-FAST AND SOFT RECOVERY
- VERY LOW OVERALL POWER LOSSES IN BOTH THE DIODE AND THE COMPANION TRANSISTOR
- HIGH FREQUENCY OPERATION
- HIGH REVERSE VOLTAGE CAPABILITY

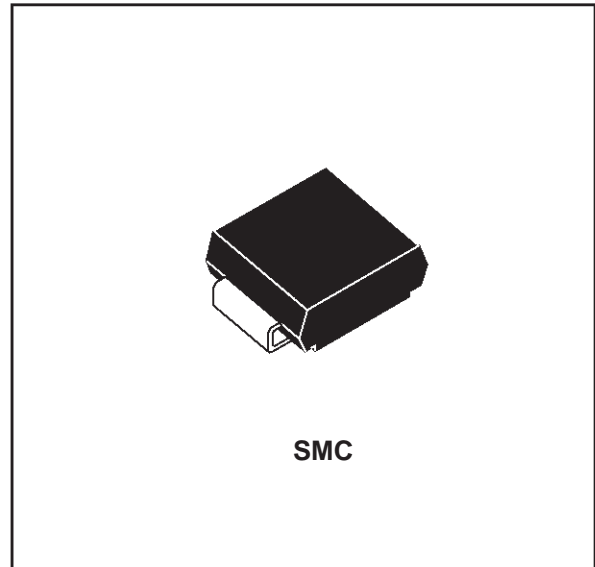

### DESCRIPTION

TURBOSWITCH 1200V drastically cuts losses in all high voltage operations which require extremely fast, soft and noise-free power diodes.

Due to their optimized switching performances they also highly decrease power losses in any associated switching IGBT or MOSFET in all "freewheel mode" operations and is particularly

suitable and efficient in motor control circuitries, or in primary of SMPS as snubber, clamping or demagnetizing diodes secondary of SMPS as high voltage rectifier diodes. They are also suitable for the secondary of SMPS as high voltage rectifier diodes.

### ABSOLUTE RATINGS (limiting values)

Symbol	Parameter	Value	Unit	
$V_{RRM}$	Repetitive peak reverse voltage	1200	V	
$V_{RSM}$	Non repetitive peak reverse voltage	1200	V	
$I_{F(RMS)}$	RMS forward current	10	A	
$I_{FRM}$	Repetitive peak forward current	$t_p = 5\mu s$ F=5kHz square	20	A
$I_{FSM}$	Surge non repetitive forward current	$t_p = 10ms$ sinusoidal	25	A
$T_{stg}$	Storage temperature range	- 65 to + 150	°C	
$T_j$	Maximum operating junction temperature	125	°C	

## STTA212S

### THERMAL AND POWER DATA

Symbol	Parameter	Test conditions	Value	Unit
$R_{th(j-l)}$	Junction to lead thermal resistance		21	°C/W
$P_1$	Conduction power dissipation	$I_{F(AV)} = 1.5A$ $\delta = 0.5$ $T_{lead} = 72^\circ C$	2.5	W
$P_{max}$	Total power dissipation $P_{max} = P_1 + P_3$ ( $P_3 = 10\% P_1$ )	$T_{lead} = 67^\circ C$	2.8	W

### STATIC ELECTRICAL CHARACTERISTICS

Symbol	Parameter	Test Conditions		Min	Typ	Max	Unit
$V_F^*$	Forward voltage drop	$I_F = 2A$	$T_j = 25^\circ C$ $T_j = 125^\circ C$		1.1	1.65 1.5	V
$I_R^{**}$	Reverse leakage current	$V_R = 0.8$ $\times V_{RRM}$	$T_j = 25^\circ C$ $T_j = 125^\circ C$		150	20 400	$\mu A$
$V_{to}$	Threshold voltage	$I_p < 3 \cdot I_{AV}$	$T_j = 125^\circ C$			1.15	V
$r_d$	Dynamic resistance					175	m $\Omega$

Test pulses : \*  $t_p = 380 \mu s$ ,  $\delta < 2\%$

\*\*  $t_p = 5 ms$ ,  $\delta < 2\%$

To evaluate the maximum conduction losses use the following equation :

$$P = V_{to} \times I_{F(AV)} + r_d \times I_F^2_{(RMS)}$$

### DYNAMIC ELECTRICAL CHARACTERISTICS

#### TURN-OFF SWITCHING

Symbol	Parameter	Test conditions	Min	Typ	Max	Unit
$t_{rr}$	Reverse recovery time	$T_j = 25^\circ C$ $I_F = 0.5 A$ $I_R = 1A$ $I_{rr} = 0.25A$ $I_F = 1 A$ $di_F/dt = -50A/\mu s$ $V_R = 30V$		65	115	ns
$I_{RM}$	Maximum recovery current	$T_j = 125^\circ C$ $V_R = 600V$ $I_F = 2A$ $di_F/dt = -16 A/\mu s$ $di_F/dt = -50 A/\mu s$		6.0	3.6	A
S factor	Softness factor	$T_j = 125^\circ C$ $V_R = 600V$ $I_F = 2A$ $di_F/dt = -50 A/\mu s$		0.9		/

#### TURN-ON SWITCHING

Symbol	Parameter	Test conditions	Min	Typ	Max	Unit
$t_{fr}$	Forward recovery time	$T_j = 25^\circ C$ $I_F = 2 A$ $di_F/dt = 16 A/\mu s$ measured at $1.1 \times V_{Fmax}$			900	ns
$V_{Fp}$	Peak forward voltage				35	V

**Fig. 1:** Conduction losses versus average current.

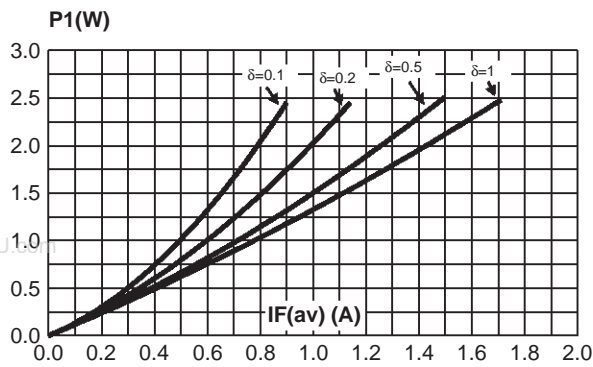

**Fig. 2:** Forward voltage drop versus forward current (maximum values).

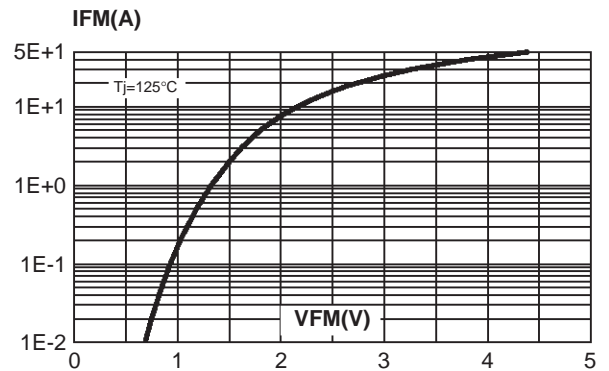

**Fig. 3:** Variation of thermal impedance junction to ambient versus pulse duration (epoxy printed circuit board FR4,  $e(\text{Cu})=35\mu\text{m}$ ,  $S(\text{Cu})=1\text{cm}^2$ ).

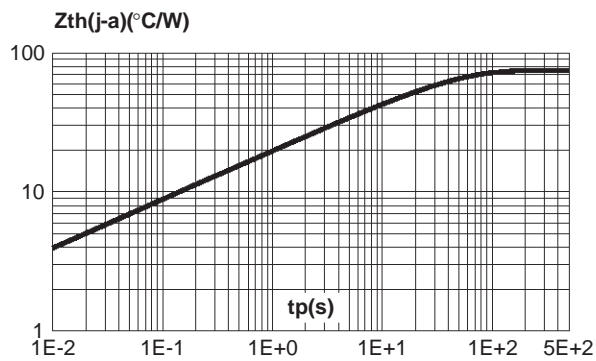

**Fig. 4:** Peak reverse recovery current versus  $dI_F/dt$  (90% confidence).

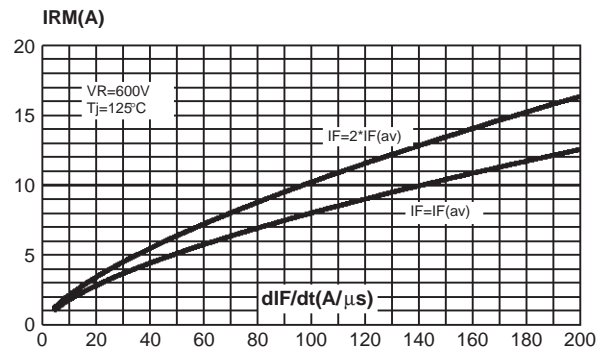

**Fig. 5:** Softness factor ( $t_b/t_a$ ) versus  $dI_F/dt$  (typical values).

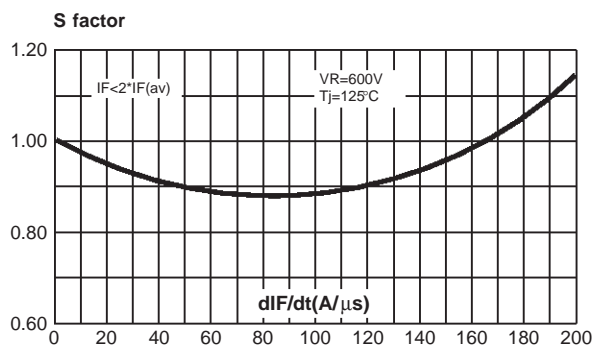

**Fig. 6:** Reverse recovery time versus  $dI_F/dt$  (90% confidence).

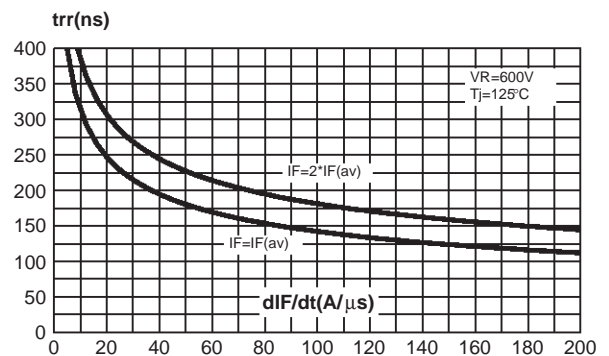

**Fig. 7:** Relative variation of dynamic parameters versus junction temperature (reference  $T_j=125^\circ\text{C}$ ).

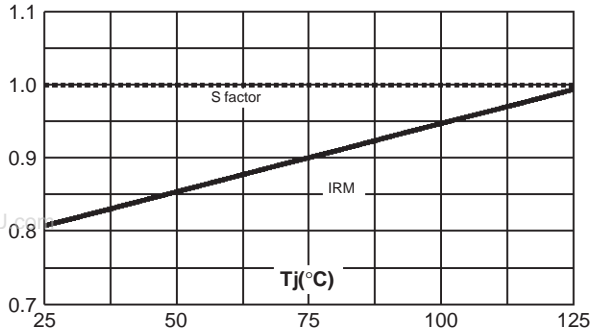

**Fig. 8:** Transient peak forward voltage versus  $dI_F/dt$ .

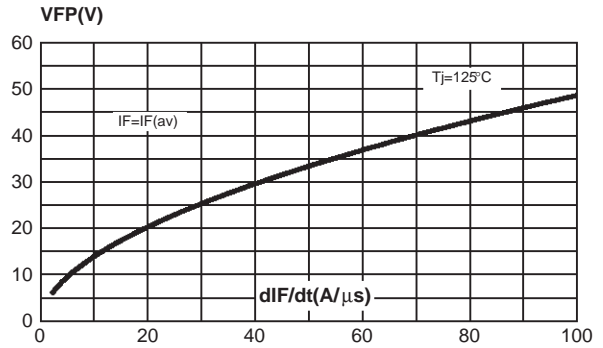

**Fig. 9:** Forward recovery time versus  $dI_F/dt$ .

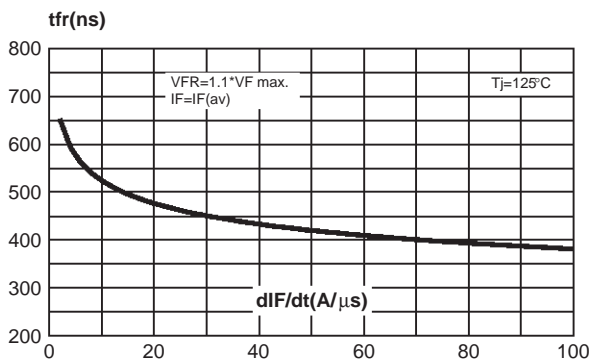

## APPLICATION DATA

The 1200V TURBOSWITCH has been designed to provide the lowest overall power losses in any all high frequency or high pulsed current operations.

In such applications (fig. A to D), the way of calculating the power losses is given below :

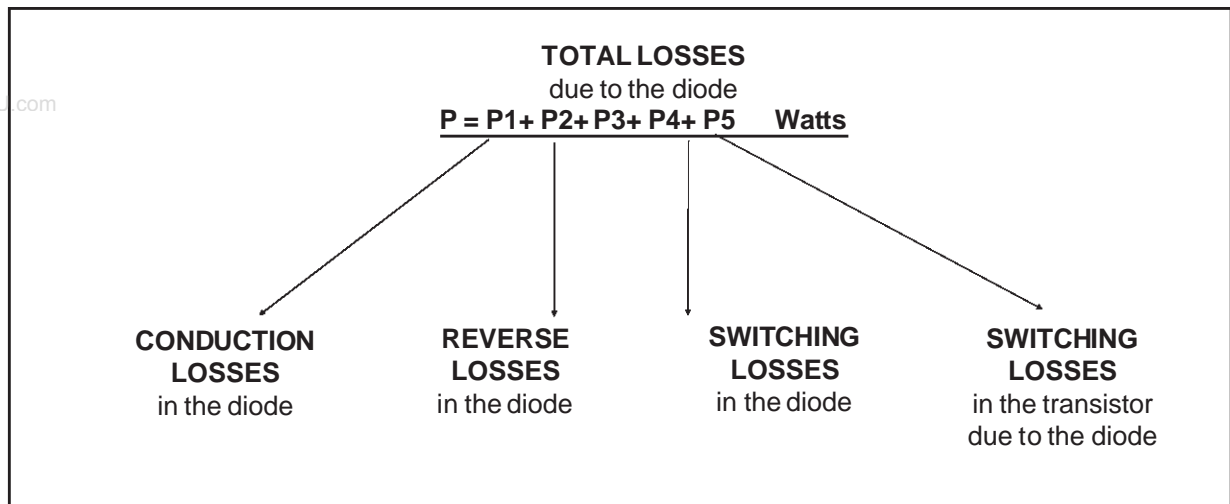
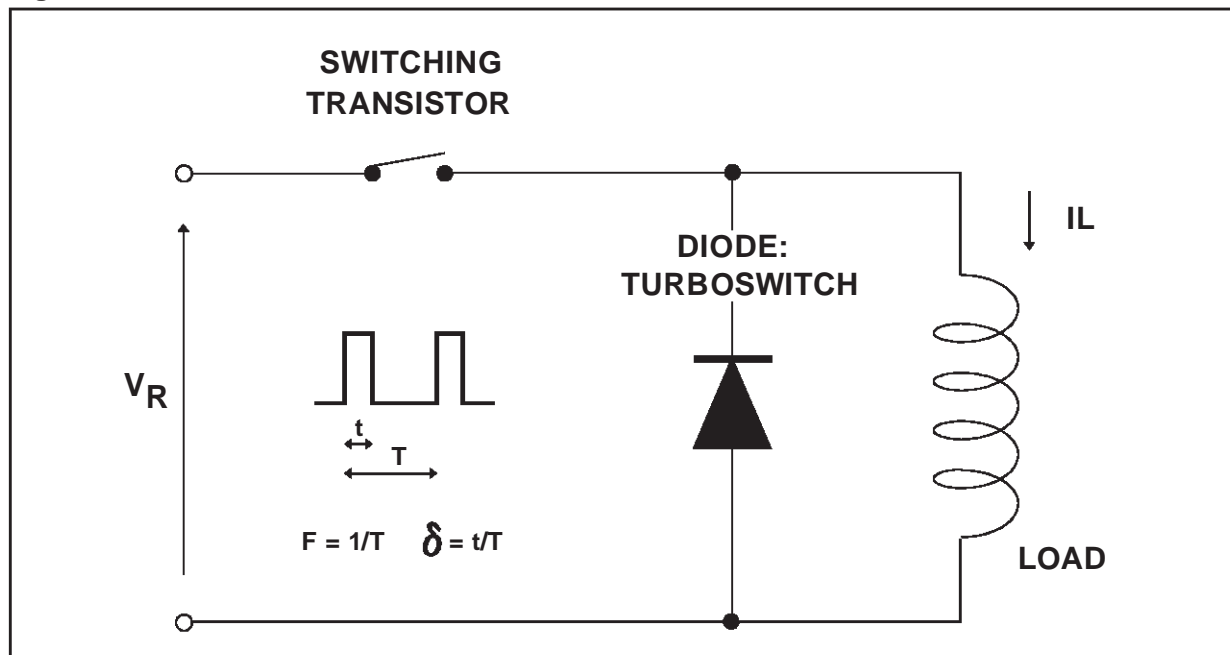

Fig. A : "FREEWHEEL" MODE



APPLICATION DATA (Cont'd)

Fig. B : SNUBBER DIODE.

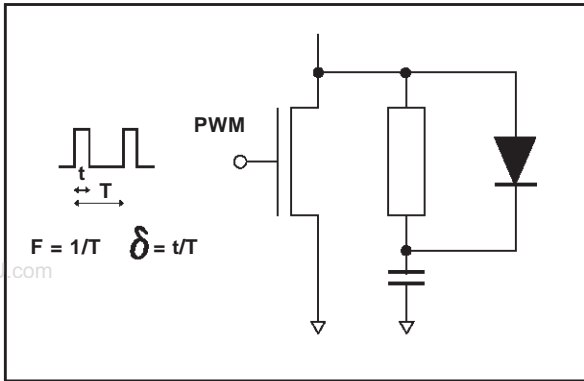

Fig. C : DEMAGNETIZING DIODE.

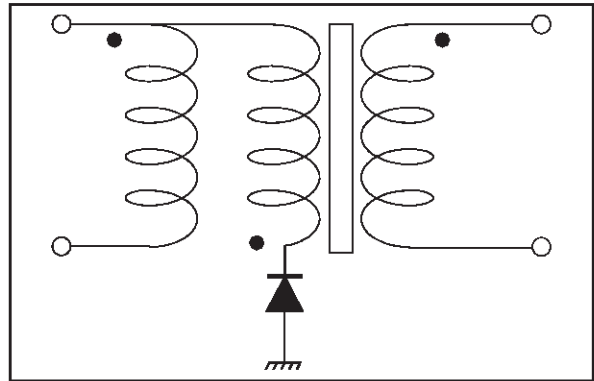

Fig. D : RECTIFIER DIODE.

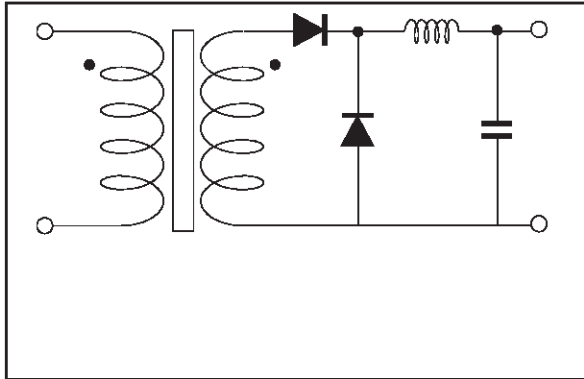
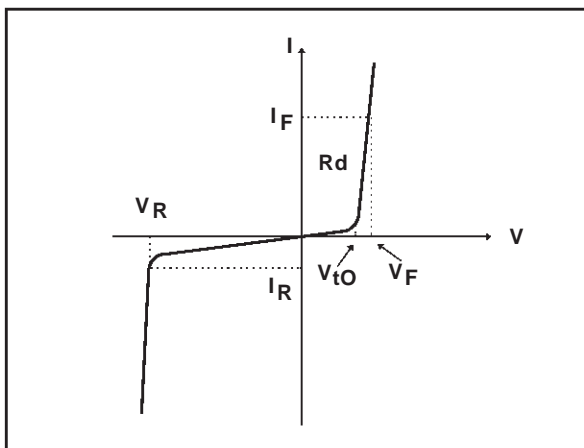

Fig. E : STATIC CHARACTERISTICS



**Conduction losses :**

$$P1 = V_{t0} \times I_F(AV) + R_d \times I_F^2(RMS)$$

**Reverse losses :**

$$P2 = V_R \times I_R \times (1 - \delta)$$

APPLICATION DATA (Cont'd)

Fig. F : TURN-OFF CHARACTERISTICS

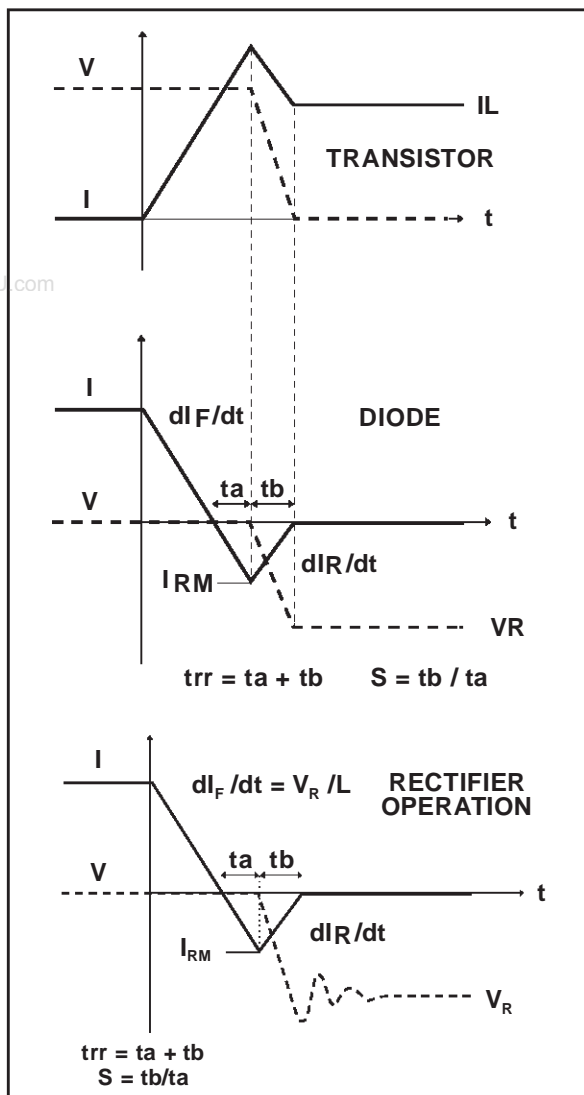

Turn-on losses :  
(in the transistor, due to the diode)

$$P5 = \frac{V_R \times I_{RM}^2 \times (3 + 2 \times S) \times F}{6 \times dI_F/dt} + \frac{V_R \times I_{RM} \times I_L \times (S + 2) \times F}{2 \times dI_F/dt}$$

Turn-off losses (in the diode) :

$$P3 = \frac{V_R \times I_{RM}^2 \times S \times F}{6 \times dI_F/dt}$$

Turn-off losses :  
with non negligible serial inductance

$$P3' = \frac{V_R \times I_{RM}^2 \times S \times F}{6 \times dI_F/dt} + \frac{L \times I_{RM}^2 \times F}{2}$$

P3, P3' and P5 are suitable for power MOSFET and IGBT

Fig. G : TURN-ON CHARACTERISTICS

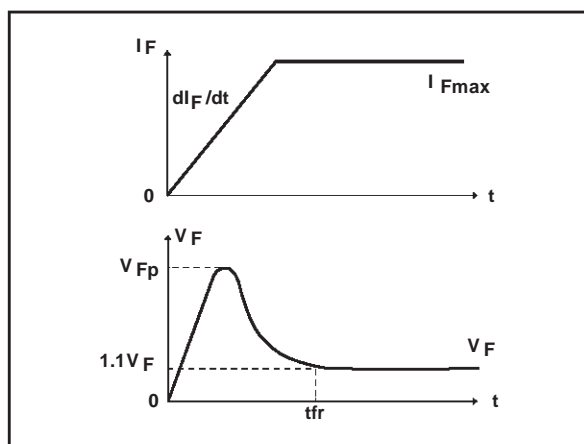

Turn-on losses :

$$P4 = 0.4 (V_{FP} - V_F) \times I_{Fmax} \times t_{fr} \times F$$

# STTA212S

## PACKAGE MECHANICAL DATA SMC

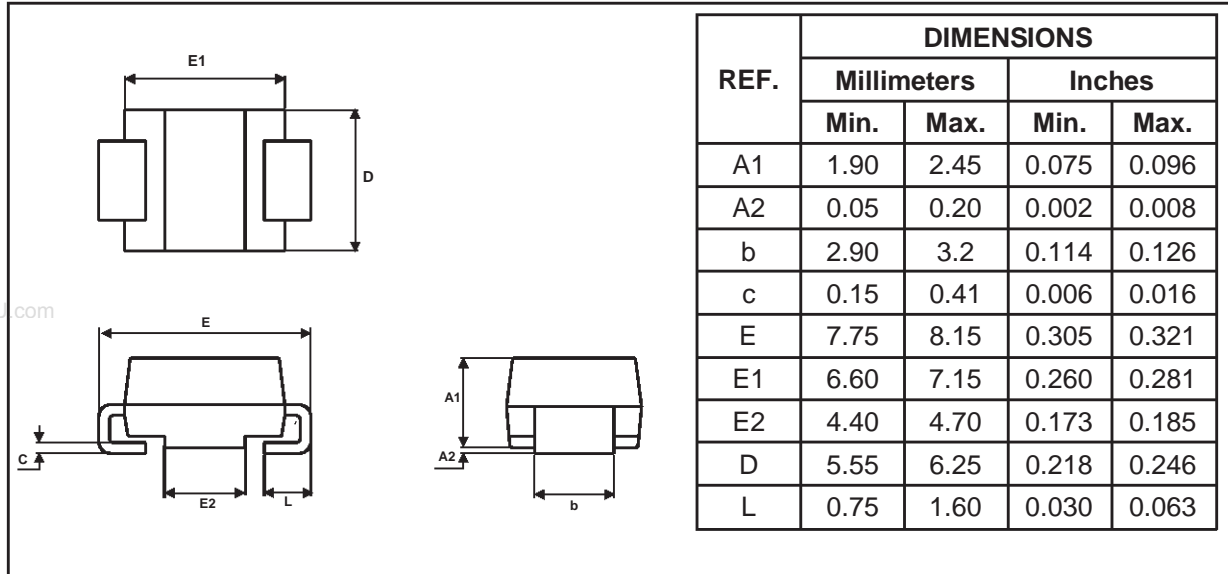

### FOOTPRINT DIMENSIONS (in millimeters) SMC Plastic

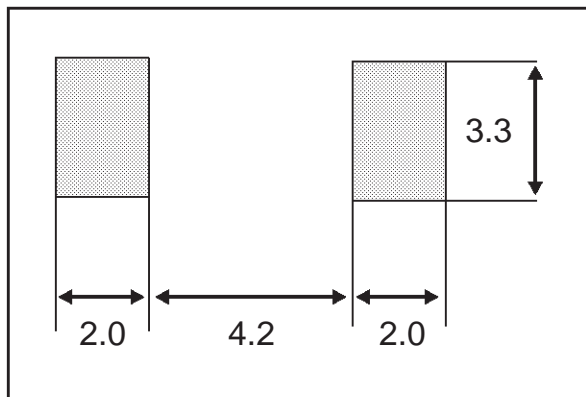

Ordering type	Marking	Package	Weight	Base qty	Delivery mode
STTA212S	T53	SMC	0.243g	2500	Tape & reel

- Epoxy meets UL94,V0
- Band indicates cathode

Information furnished is believed to be accurate and reliable. However, STMicroelectronics assumes no responsibility for the consequences of use of such information nor for any infringement of patents or other rights of third parties which may result from its use. No license is granted by implication or otherwise under any patent or patent rights of STMicroelectronics. Specifications mentioned in this publication are subject to change without notice. This publication supersedes and replaces all information previously supplied. STMicroelectronics products are not authorized for use as critical components in life support devices or systems without express written approval of STMicroelectronics.

The ST logo is a registered trademark of STMicroelectronics

© 1999 STMicroelectronics - Printed in Italy - All rights reserved.

STMicroelectronics GROUP OF COMPANIES

Australia - Brazil - China - Finland - France - Germany - Hong Kong - India - Italy - Japan - Malaysia  
Malta - Morocco - Singapore - Spain - Sweden - Switzerland - United Kingdom - U.S.A.

<http://www.st.com>