

Evaluates: MAX30009

MAX30009EVKIT# Evaluation Kit

General Description

The MAX30009EVKIT# evaluation kit (EV kit) provides a platform to evaluate the functionality and features of the MAX30009 Low-Power, High-Performance Bioimpedance (BioZ) Analog Front End. The EV kit allows for flexible hardware and software configurations to help the user quickly learn how to configure and optimize the MAX30009 for their applications.

The MAX30009 is a complete Bioimpedance (BioZ) analog front-end solution for wearable applications. It offers high performance for fitness, wellness, and clinical applications and ultra-low power for long battery life. The BioZ receive channel has ESD protection, EMI filtering, internal lead biasing, DC leads off detection, DRVN lead-off detection, and ultra-low power lead-on detection during standby mode. The BioZ receive channel also has high input impedance, low noise, high CMRR, programmable gain, various low-pass, and high-pass filter options, and two high-resolution analog to digital converters for simultaneous I and Q acquisition.

The MAX30009EVKIT# EV kit consists of two boards. MAXSENSORBLE_EVKIT_B is the microcontroller (MCU) board while MAX30009_EVKIT_B is the sensor board containing the MAX30009. The EV kit is powered by a LiPo battery, which is recharged through a USB-C cable. The EV Sys communicates with MAX30009GUI (should be installed in the user system) via Bluetooth (WIN BLE). The EV kit contains the latest firmware but comes with the programming circuit board MAXDAP-TYPE-C in case a firmware change is needed.

Ordering Information appears at end of data sheet.

Benefits and Features

- Convenient Platform to Evaluate the MAX30009
- Many Easy-to-Reach Test Points
- Real-time Monitoring and Plotting
- Data Logging Capabilities
- Bluetooth® LE
- Windows® 10 Compatible GUI software

EV Kit Contents

- MAX30009_EVKIT_B sensor board
- MAXSENSORBLE_EVKIT_B microcontroller board (assembled to MAX30009_EVKIT_B)
- 105mAh LiPo battery [LP-401230](#) (assembled to MAXSENSORBLE_EVKIT_B)
- USB-C to USB-A cable
- MAXDAP-TYPE-C programmer board
- Micro USB-B to USB-A cable
- Six electrode cables

MAX30009EVKIT# EV Kit Files

FILE	DESCRIPTION
MAX30009GUISetupVxxx_Web.zip	Setup file to install PC GUI program
MAXSENSORBLE_EVKIT_B.zip	Schematic, BOM, layout
MAX30009_EVKIT_B.zip	Schematic, BOM, layout

Note:

1. The GUI setup files can be obtained by the procedure described in the [Quick Start](#) section
2. MAXSENSORBLE_EVKIT and EVKIT design files are attached at the end of this document.

MAX30009EVKIT# Evaluation Kit

Evaluates: MAX30009

MAX30009EVKIT# Board Photo

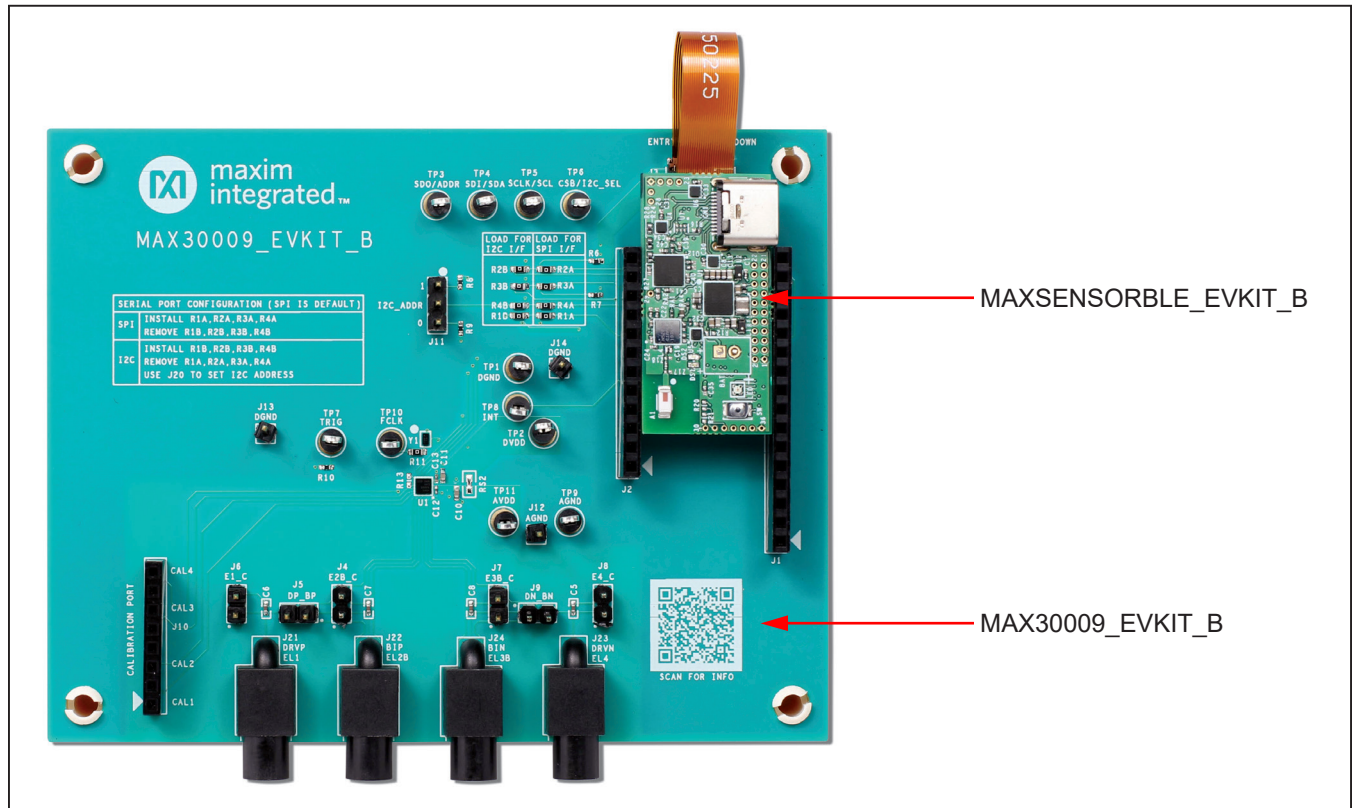

Quick Start

Required Equipment

- MAX30009EVKIT# EV kit
- USB-C to USB-A cable
- Windows System with a USB port and Bluetooth support (WIN BLE)
- 105 mAh Li-Po battery [LP-401230](#)
- Microsoft .NET framework 4.7.2 or above

Procedure

The EV kit is fully assembled and tested. Use the following steps to verify board operation:

Note: In the following sections, text in **bold** refers to items and buttons in the MAX30009EVKitGui.exe GUI program.

- 1) Confirm that the MAXSENSORBLE_EVKIT_B microcontroller (MCU) board is connected to the MAX30009_EVKIT_B board through the flex cable as shown in [Figure 1](#).

- 2) Set the EV kit on a nonconductive surface to ensure that nothing is on the PCB shorts.
- 3) Visit <https://www.analog.com/en/resources/evaluation-hardware-and-software/evaluation-boards-kits/max30009evkit.html> to download the most recent version of the EV kit software, **MAX30009GUI-SetupVxxx_Web.zip**. Save the EV kit software to a temporary folder and uncompress the zip file. The EV kit software can also be accessed by scanning the **QR code** on the EV kit board.
- 4) Launch the MAX30009GUISetupVxxx.exe and follow the instructions from the pop-up windows. This will install the MAX30009EVKitGui.exe GUI program to the user's system successfully.
- 5) Press and hold the **power switch (SW)** for 1 second to turn on the EV kit (see power switch location in [Figure 1](#)). When powered on, the green status LED indicator will toggle.

MAX30009EVKIT# Evaluation Kit

Evaluates: MAX30009

- 6) Launch the MAX30009EVKitGui.exe GUI program. A **Connect To Device** window should appear. You will see **WIN BLE** appear on the port, if multiple connections appear then select **WIN BLE**. The EV Sys device should appear under **Select a device below**. Choose the device and press **Connect**. The GUI is then launched.
- 7) Configure GUI settings if needed. Note that the electrodes are not provided in this EV kit and must be obtained elsewhere to properly measure BioZ signals.
- 8) Click the **Start** button on the bottom right to start data acquisition. When running, the plots on the GUI should stream with data. [Figure 2](#) shows an example of a plot with both I and Q BioZ enabled.

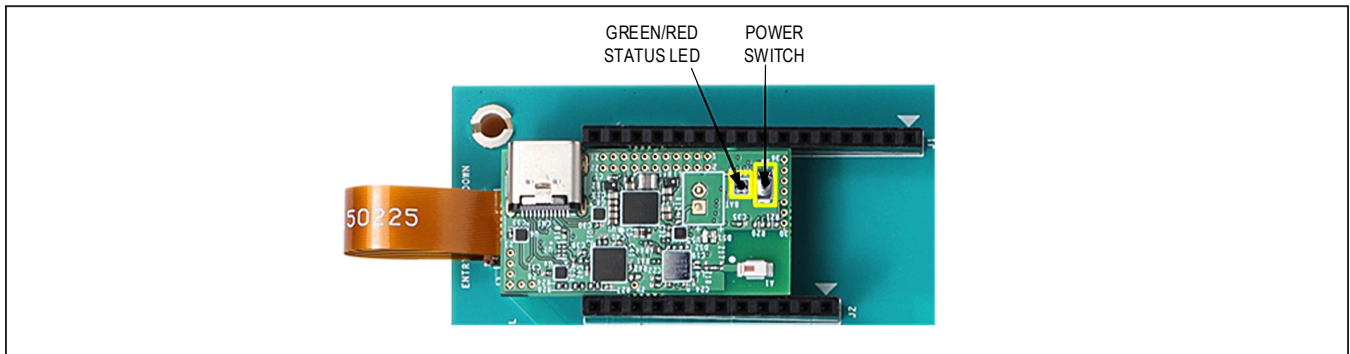

Figure 1. Power Switch for the MAX30009EVKIT# EV Kit



Figure 2. Plot of BioZ I and Q Signals

Detailed Description of Software

The EV kit allows BioZ data to be sampled and transferred to the GUI for both dynamic viewing and logging for later analysis. The EV kit microcontroller PCB performs SPI to Bluetooth® LE (BLE) communication, transporting the data to the PC through BLE. Most functionality of the MAX30009 has been mapped to the GUI so that the user can explore a wide variety of applications supported by the MAX30009. The following sections describe these functionalities.

Conventions for registers are:

- **Hexadecimal notation for addresses:** The PLL_Configuration_1 register is at hex address 0x17.
- **Individual bits within register:** The PLL_EN bit is located at 0x17.0 (bit 0 at address 0x17).
- **Bit fields within register:** The KDIV[3:0] field is located at 0x17[4:1] (bits 4 to 1 correspond to bits 3 to 0 of the KDIV field).

Software Startup

To begin Bluetooth® connection of the EV kit to the PC, ensure that Bluetooth is enabled on the PC so that it can detect the EV kit for pairing. Now turn on the EV kit. Start up the MAX30009EVKitGui.exe GUI program, which prompts a **Connect To Device** window, as shown in [Figure 3](#). In this window, click on the COM port that corresponds with the **WIN BLE** and the EV kit device should appear under **Select a device below**. Choose the EV kit and press **Connect**. The GUI will then be launched.

When launched, the software first initializes the EV kit to communicate. The software then reads the EV kit registers and updates all the associated control fields displayed on the GUI. The status strip at the bottom of the GUI displays the firmware version, GUI version, and the hardware's associated COM port.

Toolstrip Menu Bar

The Toolstrip Menu bar is located at the top of the GUI window (see [Figure 4](#)). This bar contains **File**, **Device**,

Options, **Logging**, and **Help** menus, whose functions are detailed in the following sections.

File Menu

The **File** menu contains the option to exit out of the GUI program.

Device Menu

The **Device** menu provides the ability to connect or disconnect the EV kit to the GUI. If the EV kit is disconnected while the GUI is open, the GUI will display **Disconnected** in the lower right corner. To connect, turn on the EV kit, navigate to the **Device** menu, and select **Connect**. This will open the **Connect To Device** window, allowing the user to connect. Once connection is successful, the bottom right corner of the GUI will read **Connected** and display the COM port to which the EV kit is connected.

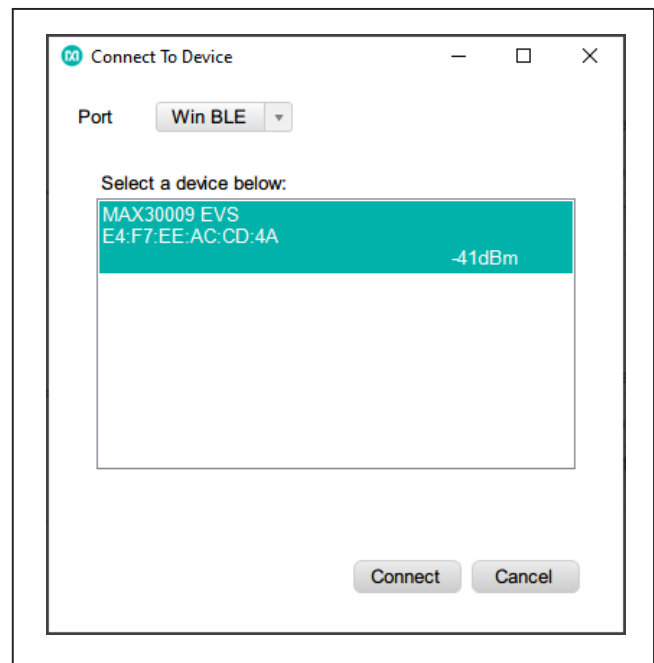

Figure 3. Connect To Device window

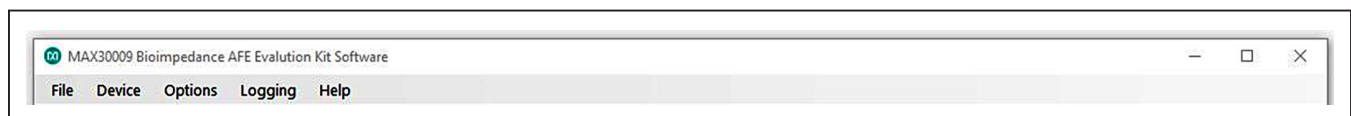

Figure 4. MAX30009EVKIT# EV Kit Toolstrip Menu Bar

Options Menu

The **Options** menu provides several settings to access more features offered by the GUI.

- **Register Import/Export** allows the user to save register settings in a Windows CSV file (**Export**) and to quickly set up the GUI based on register settings from a previously exported CSV file (**Import**).
- **Plot Time Scale** allows the user to select the total number of seconds of data they want to see on the plot.
- **Advanced** provides the **Register Access** selection which reveals more register and system settings in the **Registers** tab for the user to customize.

Logging Menu

The **Logging** menu provides a way to export exact data measured by the EV kit. There are two options available: **File** to save data to a Windows CSV file or **Flash** to save data in the EV kit's flash memory. When the MAX30009EVKIT# EV kit is plugged in to the PC through the USB-C to USB-A cable, the option **Parse Bin File** parses the binary file saved in the flash memory into a ".csv" file. See the [Data Logging](#) section of this datasheet for more details.

Help Menu

The **Help** menu contains GUI information and links that can help with GUI issues.

Data Acquisition Bar

The Data Acquisition bar is located at the bottom of the GUI window (see [Figure 5](#)). This bar displays EV kit status, GUI status, a **Start/Stop** button, and a **Reset** button.

EV kit and GUI Status

The status indicators include:

- **Part:** Reads the Part ID (0xFF) and displays the result.
- **FW:** Firmware version loaded onto MAXSENSORBLE_EVKIT_B board.
- **SW:** GUI software version.
- **Battery:** Shows battery charge level (1 to 10).
- **File Log:** Enabled or Disabled as set in the Logging menu.
- **Flash Log:** Enabled or Disabled as set in in the Logging menu.
- **Connected:** Displays "Connected" (with MAC address and COM port) or "Disconnected" state of EV kit board.
- **RSSI, Dropped Count, and Tag Error Count:** Bluetooth® debug fields. RSSI indicates Bluetooth® signal strength, which should be above -70dBm. If below that level, move the EV kit board closer to the laptop/PC.

Start/Stop Button

Clicking **Start** begins data acquisition and visualizes the data in the **Plots** tab. During data acquisition, the **Start** button turns into a **Stop** button. Click this **Stop** button to stop data acquisition and data visualization.

Reset Button

Clicking **Reset** resets all registers and GUI settings to predefined default values.

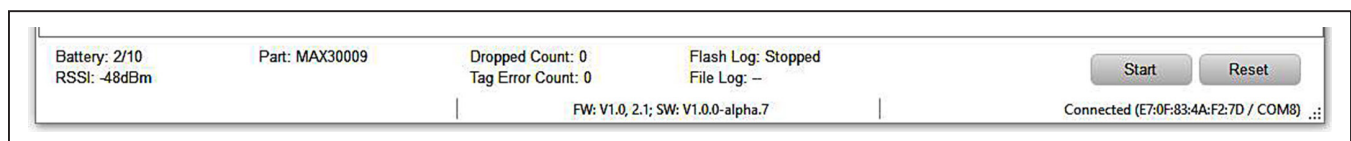

Figure 5. MAX30009EVKIT# EV Kit Data Acquisition Bar

PLL Tab

The **PLL Tab** (see [Figure 6](#)) sets up the master clock and the divider ratios for the generation of the various device clocks. The clock values are discussed in the MAX30009 IC data sheet, along with tables containing values for easy clock frequency setup.

PLL Enable

Checkbox is checked if `PLL_EN(0x17b0) = 1`, indicating that the PLL is enabled.

Source Select and Clock Selection

Source Select = Internal: The **Clock Selection** pull-down box selects the internal oscillator frequency (32.768kHz or 32kHz).

Source Select = External: Clock source is a low-jitter external 32.867kHz oscillator connected to the device FCLK input pin. The **Clock Selection** field must be set to 32.768kHz.

Generating PLL Frequency

PLL frequency is generated by multiplying the **Clock Selection** frequency with **M Divider**. PLL frequency ranges from 14MHz to 28MHz. At 32kHz, M Divider range is 438 to 875. At 32.768kHz, M Divider range is 427 to 854.

BioZ Drive: BioZ Synth Clock (K Divider) and Drive Frequency (DAC OSR)

The **BioZ Synth Clock** frequency must be between 4.096kHz and 28MHz. The frequency is set by dividing the PLL Frequency by the **K Divider** value. The **Drive Frequency** is generated by dividing the **BioZ Synth Clock** frequency by the **DAC OSR** value.

BioZ Receive: BioZ ADC Clock (N Divider) and Sample Rate (ADC OSR)

The **BioZ ADC Clock** frequency must be between **16.0kHz** and **36.375kHz**. The frequency is set by dividing the PLL Frequency by the **N Divider** value. The **Sample Rate** is generated by dividing the **BioZ ADC Clock** frequency by the **ADC OSR** value.

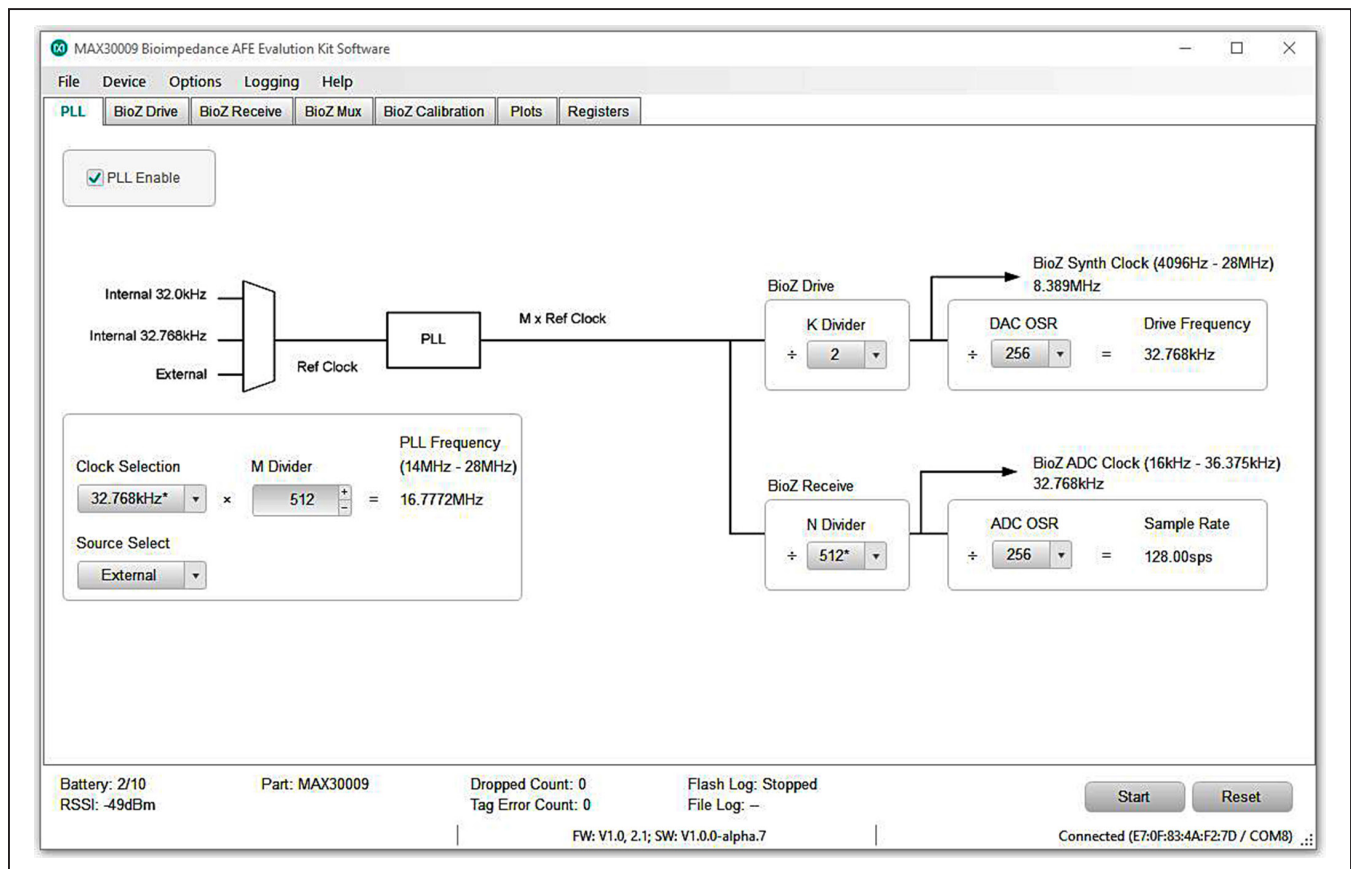

Figure 6. MAX30009EVKIT# EV Kit PLL tab

BioZ Drive Tab

The **BioZ Drive Tab** (see [Figure 7](#)) configures the stimulus generator.

BioZ Enable

Enabling BioZ allows bioimpedance data to be acquired and plotted in the **Plots** tab. This field is also available and can be set from the BioZ Receive and BioZ Calibration tabs.

- **Disabled:** No samples are captured.
- **I-Channel:** Enable BioZ measurement from an in-phase component.
- **Q-Channel:** Enable BioZ measurement from quadrature-phase component.
- **I- and Q-Ch:** Enable both in-phase and the quadrature BioZ measurement.

Current DAC Drive Mode

The BioZ drive channel offers several modes of stimulation that can be selected. The BioZ drive has several different options which configure the internal amplifiers and switches to support waveforms for various applications.

- **Current:** Output stimulus is sine wave current.
- **Voltage:** Output stimulus is sine wave voltage.
- **H-Bridge:** Output stimulus is square wave voltage from the H-Bridge source.
- **Standby:** Low-power state where electrodes are driven to V_MID_TX. **Standby** is useful in saving power during ultra-low power (ULP) lead-on detection.

There are several necessary connections to ensure patient safety. When using sine wave current as a stimulus, the **Use External Capacitor** option should be

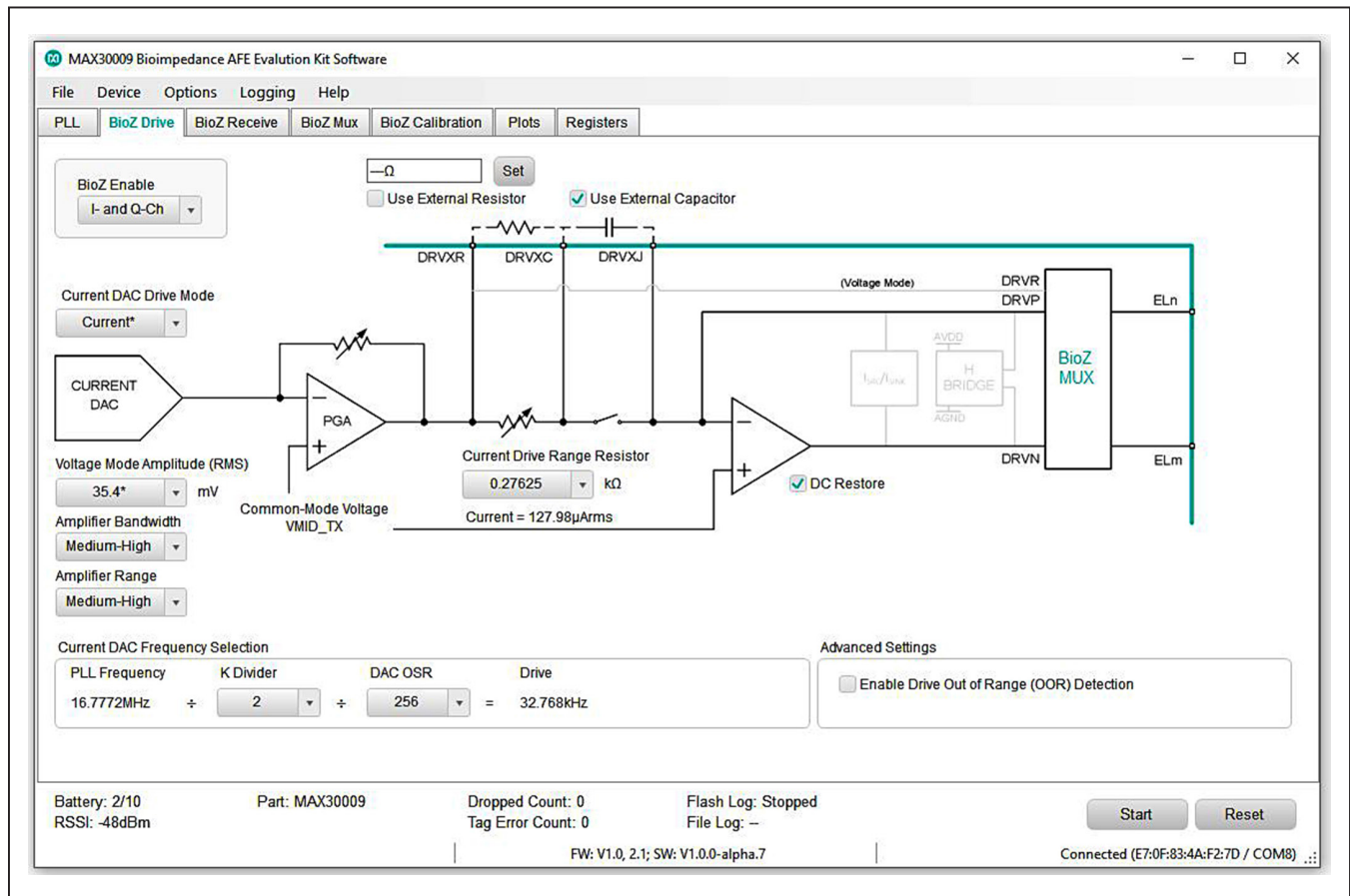

Figure 7. MAX30009EVKIT# EV Kit BioZ Drive tab

selected by default to use a 47nF capacitor provided by the EV kit to block DC currents from being driven into the patient. When using voltage mode or H-bridge mode as a stimulus, there must be external series precision resistors connected in the DRVP and DRVN paths, and the pins EL1 and EL4 should be connected to DRVP and DRVN respectively. See the [BioZ Configurations](#) subsection in the [Detailed Description of Hardware](#) section of this datasheet for hardware components provided by the EV kit.

Voltage Mode Amplitude

Voltage Mode Amplitude can adjust current and voltage amplitudes from the Current DAC. There are four settings, 35.4mV, 70.7mV, 177mV, and 354mV. When **Voltage** is selected for the **Current DAC Drive Mode**, the **Voltage Mode Amplitude** sets the voltage RMS amplitude at DRVVR. When **Current** is selected for **Current DAC Drive Mode**, the **Voltage Mode Amplitude**, and **Current Drive Range Resistor** sets the current magnitude and changes the voltage amplitude at DRVVR depending on the current drive range resistor used.

Note that certain amplitudes are not available for certain stimulus frequencies to align with safety standards. Refer to the *MAX30009 IC datasheet under the BioZ Transmit Channel* section for recommended settings and safety limits.

Amplifier Settings

The BioZ drive channel contains various amplifier settings to adjust for different BioZ applications. **Amplifier Range** sets the output stage option for the voltage drive (1st) and current drive (2nd) amplifiers. Higher amplifier ranges are recommended for higher output current loading, although this will consume more power. **Amplifier Bandwidth** sets the gain bandwidth of the voltage drive and current drive amplifiers. Higher bandwidth is recommended for high-frequency applications including bioimpedance analysis and impedance cardiography. Low bandwidth is recommended for low-frequency applications including galvanic skin response to reduce power consumption. Refer to the *MAX30009 datasheet under the BioZ Transmit Channel* section for more details.

Current Drive Range Resistor

The BioZ drive channel allows for custom current magnitudes to be defined through an internal range resistor. The **Current Drive Range Resistor** sets the value of this resistor. There are four resistor settings, 552.5k Ω ,

100.5k Ω , 5.525k Ω , and 276.25 Ω . When **Current** is selected for **Current DAC Drive Mode**, the **Voltage Mode Amplitude** and **Current Drive Range Resistor** sets the current magnitude. Refer to the *MAX30009 datasheet under the BioZ Transmit Channel* section for more details.

External Resistor

The BioZ drive channel allows for custom current magnitudes to also be defined through an external resistor in place of the internal range resistors. Selecting **Use External Resistor** selects the external resistor inserted between DRVXR and DRVXC pins to be used in place of the internal range resistors. In this case, **Current Drive Range Resistor** is ignored. R13 on the EV kit is the external resistor in a standard 0402 SMT package size. This resistor is not populated on the EV kit to allow the user to populate their own external resistor value. When this option is selected, the resistor value should be entered (in Ω) and the **Set** button should be pressed. This will calculate and display the RMS drive current under the **Current Drive Range Resistor** pull-down box.

External Capacitor

When sine wave current is used for stimulation, an external capacitor must be inserted between DRVXC and DRVSJ to couple AC stimulus current and prevent DC from passing into the patient. Deselecting **Use External Capacitor** bypasses this external capacitor.

DC Restore

The BioZ drive channel contains a 10M Ω feedback resistance to the current drive amplifier to maintain DC bias of the drive electrodes during a lead-off event and reduce amplifier settling time when the lead is reconnected. Enabling **DC Restore** applies this feedback resistance, and is required when AC-coupling capacitors are included in the stimulus path (E1_C and/or E4_C jumpers are open).

Current DAC Frequency Selection

The BioZ drive frequency is generated by dividing the output of the PLL by **K Divider** and **DAC OSR**. Changing these fields also changes their values in the **PLL tab**.

Advanced Settings: Enable Drive Out of Range (OOR) Detection

This checkbox is identical to the **DRVN Out of Range Enable** checkbox on the BioZ Mux tab. See the description in the [BioZ Mux](#) tab section of this document.

BioZ Receive Tab

The **BioZ Receive Tab** (see [Figure 8](#)) configures the receive channel.

BioZ Mux

This block shows the location of the BioZ Mux and provides a link to directly open the **BioZ Mux** tab.

BioZ Enable

Enabling BioZ allows bioimpedance data to be acquired and plotted in the **Plots** tab. This field is also available and can be set from the **BioZ Drive** and **BioZ Calibration** tabs. See the description for this field in the [BioZ Drive Tab](#).

External HPF Capacitor

External capacitors can be connected at the BIP and BIN inputs for high-pass filtering. Enter the value of these capacitors in the **External HPF Capacitor** box and click **Update HPF** to update. This value is required to calculate the allowable corner frequencies for **Analog HPF**. The EV kit board has 47nF external HPF capacitors installed, but the user has the option of changing the capacitors to other values and updating this field in the GUI. These external capacitors are enabled by opening the E2B_C and E3B_C jumpers.

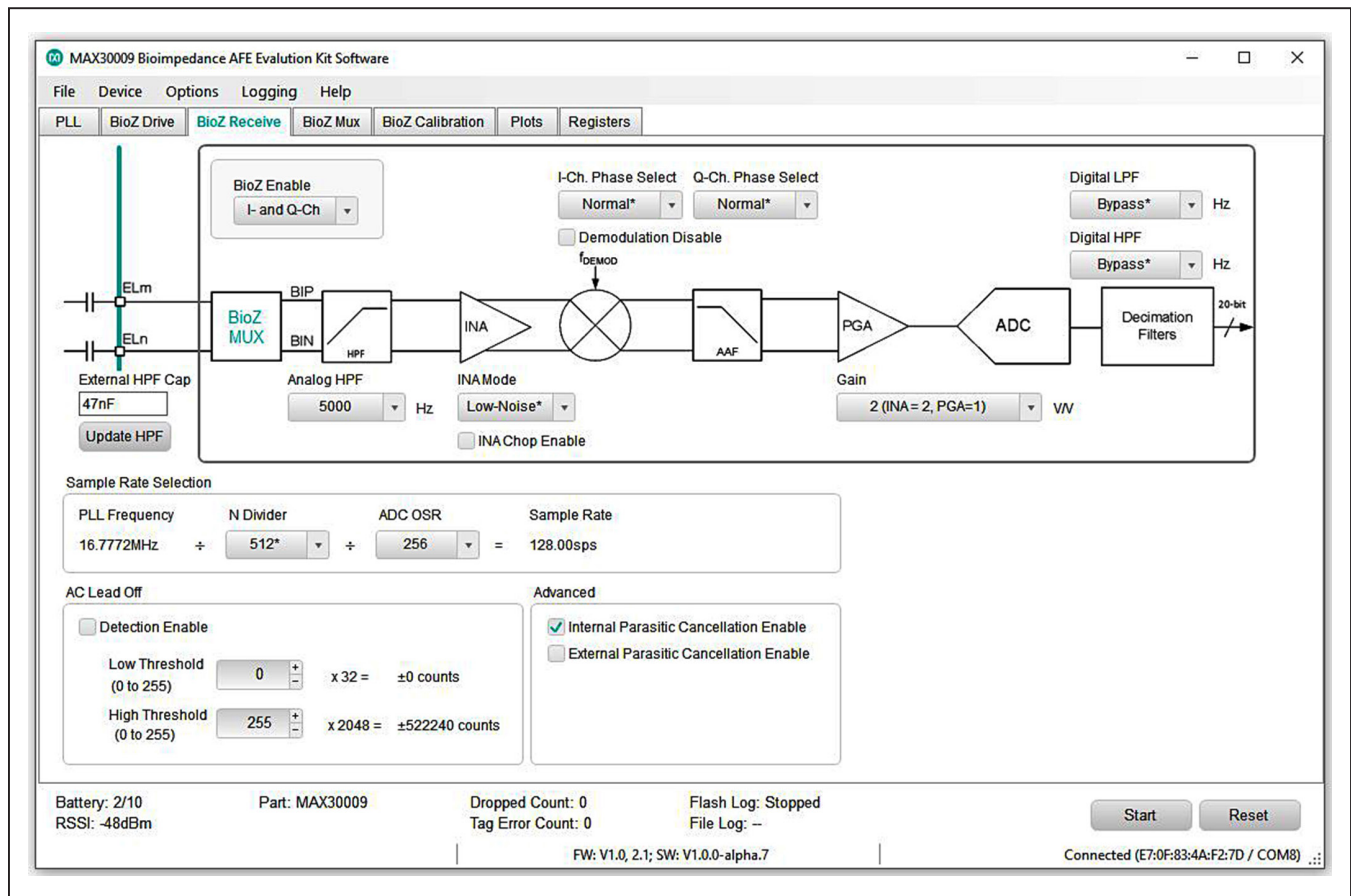

Figure 8. MAX30009EVKIT# EV Kit BioZ Receive Tab

Analog HPF

The BioZ receive channel contains an analog HPF with two filtering options. First, the MAX30009 has an internal HPF, with corner frequencies ranging from 100Hz to 10000Hz. Second, the internal HPF can use the external HPF capacitor in replacement of its internal capacitor. The allowable corner frequencies are automatically calculated based on the **External HPF Capacitor**. The analog HPF can be disabled by selecting **Bypass**. Refer to the *MAX30009 datasheet under the BioZ Receive Channel* section for more details.

INA Mode

The BioZ receive channel contains a variable gain instrumentation amplifier (INA) with two modes of operation. Select **Low-Power** for **INA Mode** to reduce power consumption, though this will result in lower SNR.

Demodulation Phase Select

The BioZ receive channel contains custom configurations for demodulation. **I-Ch. Phase Select** and **Q-Ch. Phase Select** allows the demodulation clocks to be shifted by 90° with respect to their normal phases. This is useful for calibration procedures and evaluating channel gain matching. Selecting **Demodulation Disable** disables demodulation and allows direct conversion of the differential input voltage across BIP and BIN.

Gain

The BioZ receive channel gain is set by the combined gains of INA and PGA. There are four gain settings 1V/V, 2V/V, 5V/V, and 10V/V.

Digital Filters

The BioZ receive channel offers digital high pass filtering and low pass filtering. The cutoff frequencies for these filters are automatically calculated based on the BioZ ADC sample rate.

Sample Rate Selection

The BioZ receive channel sample rate is generated by dividing the output of the PLL by **N Divider** and **ADC OSR**. These values can also be set in the **PLL** tab.

AC Lead Off

The MAX30009 BioZ channel can perform AC Lead-Off detection by comparing the BioZ ADC output to the **Low Threshold** and **High Threshold**. If the output remains over the **High Threshold** or under the **Low Threshold** for over 128ms, the **BIOZ_OVER** or **BIOZ_UNDER** status bit is asserted.

Advanced Settings

Selecting **Internal Parasitic Cancellation Enable** or **External Parasitic Cancellation Enable** helps mitigate the effects of parasitic capacitances to ensure phase accuracy in the BioZ measurement. Internal Parasitic Cancellation enables internal negative capacitances on BIP and BIN to cancel the MAX30009's inherent input capacitance. External Parasitic Cancellation enables internal guard buffers to output guard signals at pins EL2A and EL3A, which are connected to guard traces on the MAX30009EVKIT# EV kit board that surround the BIP and BIN nets to mitigate the effect of parasitic capacitances. Refer to the *MAX30009 datasheet* for more details.

BioZ Mux Tab

The **BioZ Mux Tab** (See [Figure 9](#)) configures the mux that assigns pins to **DRVP**, **BIP**, **BIN**, and **DRVN** to support various BioZ applications.

Wiring of MAX30009EVKIT# EV Kit Board

The MAX30009EVKIT# EV Kit board dedicates pins **EL2A** and **EL3A** as circuit guards for pins EL2B and EL3B so EL2A and EL3A cannot be selected by the mux for electrode connections. In Tetrapolar electrode applications, pins EL2B and EL3B should be connected to BIP and BIN in the mux so that the **External Parasitic Cancellation Enable** in the **BioZ Receive** tab functions correctly.

Mux Enable

Enabling the mux connects electrode pins as selected by **DRVP Assign**, **BIP Assign**, **BIN Assign**, and **DRVN Assign**. Disabling the mux disconnects all electrode and calibration pins.

DRVN Out of Range Enable

The MAX30009 BioZ channel can perform DRVN lead-off detection by monitoring the voltage of DRVN and triggering the **BIOZ_DRV_OOR** status bit when either the DRVP or DRVN lead is disconnected. This is useful when using a tetrapolar electrode configuration. Selecting **DRVN Out of Range Enable** enables DRVN lead-off detection. This function can also be enabled in the **Advanced Settings: Enable Drive Our of Range (OOR) Detection** of the **BioZ Drive** tab. **DRVN Out of Range Enable** is also useful to detect if the Current magnitude selected in the BioZ Drive tab is too large for the combined impedance of the DRVP and DRVN electrode-tissue interfaces and the body impedance.

Lead Bias

Lead-biasing drives the electrodes within the input common-mode voltage requirements of the BioZ channel. It is recommended to enable both the BIP and BIN Resistive Bias for tetrapolar measurements when any of the Ex_C jumpers are open.

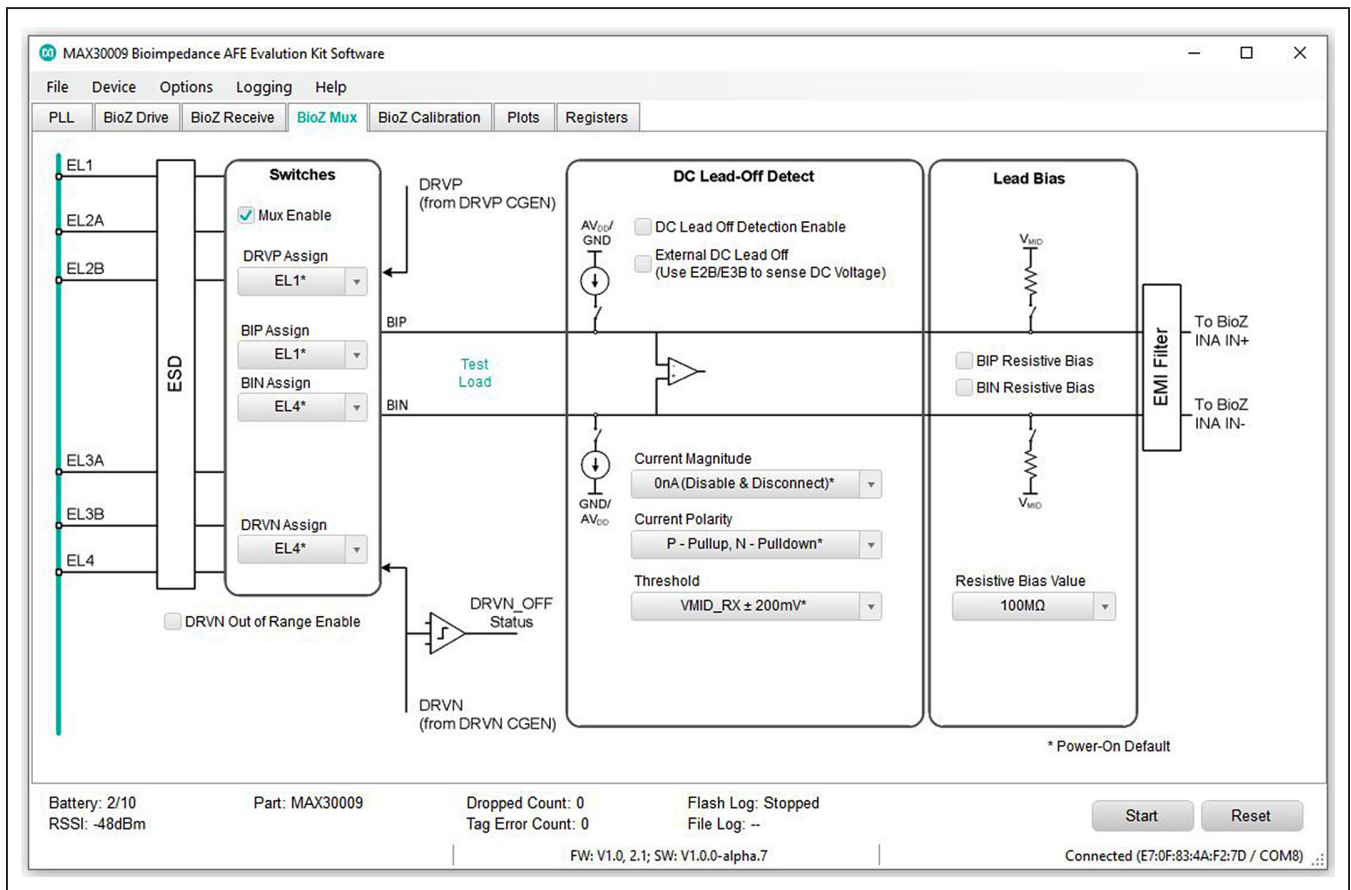

Figure 9. MAX30009EVKIT# EV Kit BioZ Mux Tab

DC Lead-Off Detect

The MAX30009 BioZ channel can perform DC lead-off detection by injecting DC current and comparing the differential voltage across BIP and BIN to the voltage thresholds selected in the **Threshold**. The DC source and sink currents are defined in the settings **Current Magnitude** and **Current Polarity**. The External DC Lead Off function is not supported by the MAX30009EVKIT# EV kit board wiring. Refer to the MAX30009 *datasheet* under the *Leads Off Detection* section for more details.

BioZ Calibration Tab

The **BioZ Calibration Tab** is shown in [Figure 10](#).

The MAX30009 BioZ channel can be calibrated to ensure accurate impedance measurements. For proper calibration, gain and phase errors need to be calculated for each stimulus frequency. Refer to the MAX30009 *IC datasheet* under the *BioZ Calibration* section for a full description of the calibration procedure and equations to calculate gain and phase errors.

The calibration procedure uses either internal programmable resistors or an external calibration resistor connected at the calibration pins or at the electrode pins. The resistor options are selected in the **Calibration Resistor** box. Only one option (external or internal) should be selected.

For internal calibration, the MAX30009 provides two internal programmable resistors: BioZ test resistors and GSR test resistors. When these internal resistors are used the **Mux Enable** in the **BioZ Mux** tab should be deselected to avoid external interference, and only one internal resistor type (BioZ or GSR) should be selected.

The BioZ test resistors are a selection of low impedance resistors meant for BIA/BIS applications. These resistors have nominal values, but due to tolerance errors a measurement is performed during the device test and the resistor error correction value is stored as the BIST_R_ERR in register 0x44. The GUI uses this value to calculate and display the **Actual Resistance (Error Corrected)** value for use in calibration calculations.

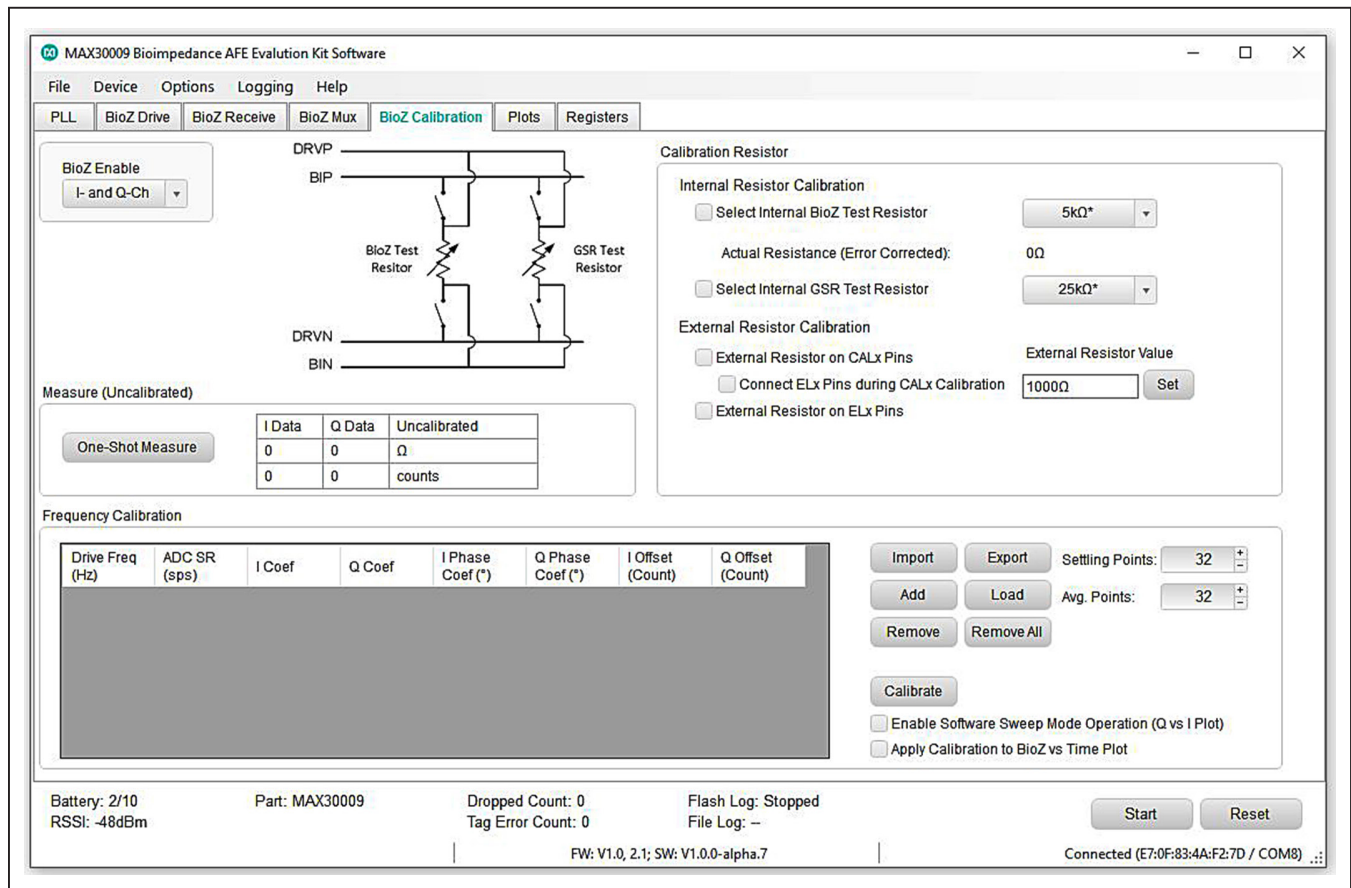

Figure 10. MAX30009EVKIT# EV Kit BioZ Calibration Tab

The GSR test resistors are a selection of four high impedance resistors meant for GSR/EDA applications.

For external calibration, a calibration resistor must be connected either to the CALx pins or to the ELx electrode outputs. The resistor value must be entered into the **External Resistor Value** box and the **Set** button must be pressed to update the value.

To use the CALx pins, select **External Resistor on CALx pins**, which connects CAL1 pin to DRVP, CAL2 pin to BIP, CAL3 pin to BIN, and CAL4 pin to DRVN through the BioZ Mux. The **CALx** pins are brought out to the CALIBRATION PORT (connector J10) which can be connected to the calibration resistor. Pins CAL1 and CAL2 should be connected to one side of the resistor with CAL3 and CAL4 connected to the other side of the resistor. The **Connect ELx Pins during CALx Calibration** checkbox provides the option of connecting the ELx pins in addition to the CALx pins through the BioZ Mux, which is designed to add the ELx parasitic effects during the CALx calibration.

An external resistor can also be connected between the pins of the electrodes. Select **External Resistor on BIOZ_ELx Pins** and connect the resistor between the DRVP/BIP and DRVN/BIN pins.

The **One-Shot Measure** button can be used to get a quick measurement of voltage and impedance using the settings defined in BioZ Drive, BioZ Receive, and BioZ Mux without having to start data acquisition and having to view measurements in the **Plots tab**. This is useful for calibration.

The **Frequency Calibration** box contains the functions to set up the calibration frequencies.

- **Import:** Loads frequency calibration CSV file previously saved by **Export** function.
- **Export:** Saves the frequency calibration setup to a CSV file for future use.

- **Add:** Reads the settings from the **PLL** tab and adds an entry to the calibration frequency selection table with a specific drive frequency and sample rate.
- **Load:** After the user selects a specific frequency calibration setting line, **Load** programs the PLL registers based on the Drive Freq and ADC SR values in the line.
- **Remove:** Removes a line in the calibration frequency selection table. To select a line, click on any field of that specific line in the calibration frequency selection table.
- **Remove All:** Clears the calibration frequency selection table.
- **Settling Points:** Number of samples that are taken but not used, to allow the impedance measurement to settle.
- **Average Points:** Number of impedance samples averaged to derive calibration values.
- **Calibrate:** Performs the calibration at each frequency, calculates the coefficients, and offsets and populates those fields with the calculated values.
- **Enable Software Sweep Mode Operation (Q vs. I Plot):** This mode performs an automated measurement sweep at the frequencies defined in the table. The measurement timing is defined by the **Settling Points** and **Average Points**. Calibration is automatically applied to the measurements, and the calibrated data is displayed on the **BioZ (Q vs. I)** plot on the **Plots** tab.
- **Apply Calibration to BioZ vs. Time Plot:** Selecting this option applies the calibration at the loaded frequency to the **BioZ**, **BioZ (Mag/Ph)**, and **Combination** plots in the **Plots** tab. This is useful to observe calibrated time-domain signals.

Plots Tab

The **Plots Tab** is shown in [Figure 11](#).

The **Plots tab** plots the enabled BioZ measurements in various formats.

- **BioZ:** Displays the I-Channel and Q-Channel measurements versus time.
- **BioZ (Mag/Ph):** Displays the calculated magnitude and phase versus time. Magnitude is calculated as $\sqrt{I^2 + Q^2}$, and Phase is calculated as $ATAN(Q/I)$.
- **BioZ (Q vs. I):** Displays frequency sweep data in

the form of a Cole-Cole plot. This plot is enabled by selecting **Enable Software Sweep Mode Operation (Q vs. I Plot)** on the **BioZ Calibration** tab and should only be used after performing a calibration at multiple frequencies.

- **Combination:** Displays two selectable values from the **BioZ** and **BioZ (Mag/Ph) plots vs. time**.

Select **Plot Time Scale** under **Options** in the Toolstrip Menu Bar to change the time scale. Calibration may be applied to time-domain plots by selecting **Apply Calibration to BioZ vs. Time Plot** in the **BioZ Calibration** tab.

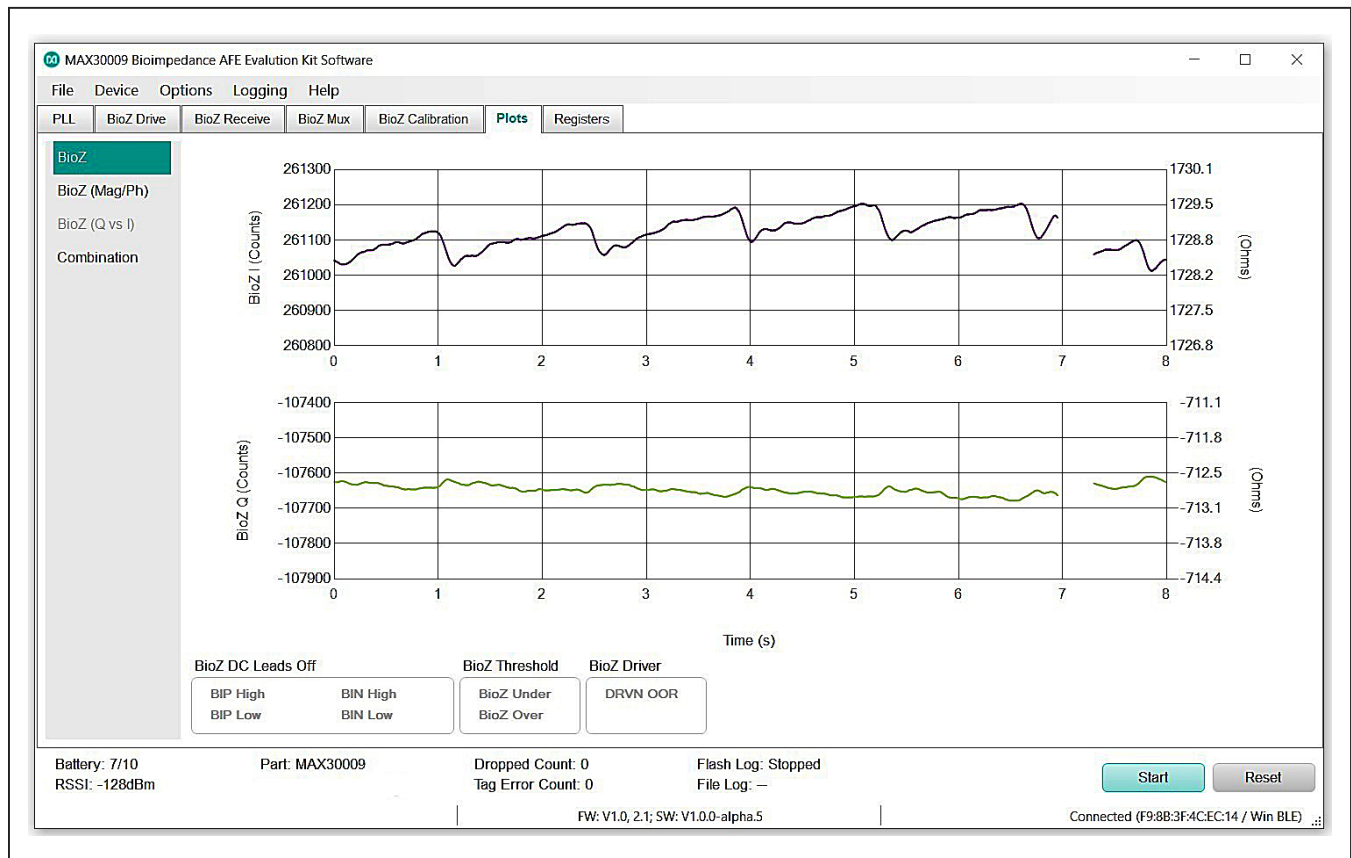

Figure 11. MAX30009EVKIT# EV Kit Plots Tab

Registers Tab

The **Registers Tab** is shown in [Figure 12](#).

The **Registers tab** allows the user to read and write registers. Register bits in **bold** text = 1, while register bits in regular text = 0. Click **R** to read register or **Read All** at the top right to read all registers.

To write a register bit: Click the specific bit to set or clear, then click the **W** button next to the register to write the entire register to the device on the EV kit.

To write a hex value to a register: Type the value into the test box to the right of the register then click the **W** button to write the entire register to the device on the EV kit.

If you do not click **W** then the bit value will not be written.

Note: The GUI interface, besides the **Register** tab, reflects commonly used register values and does not reflect all possible register values. Take caution when

customizing register values in the **Registers** tab, as they may not be reflected in the GUI interface.

Data Logging

The **Data logging** section explains how to save data. Data can be saved directly to the PC in a “.csv” file or in the MAX30009EVKIT# EV kit flash memory.

Setup

To directly save data to the PC, select File data logging in the **Logging Menu**. The GUI then asks for a folder location where the “.csv” file will be saved. Logging begins when **Start** is clicked and ends when **Stop** is clicked. This creates a “.csv” file in the defined folder location and saves data to the file.

To save data in the flash memory, select Flash logging in the **Logging Menu**. The EV kit first clears existing flash memory and then logs raw sensor data to the integrated 32MB flash memory chip in a binary file format.

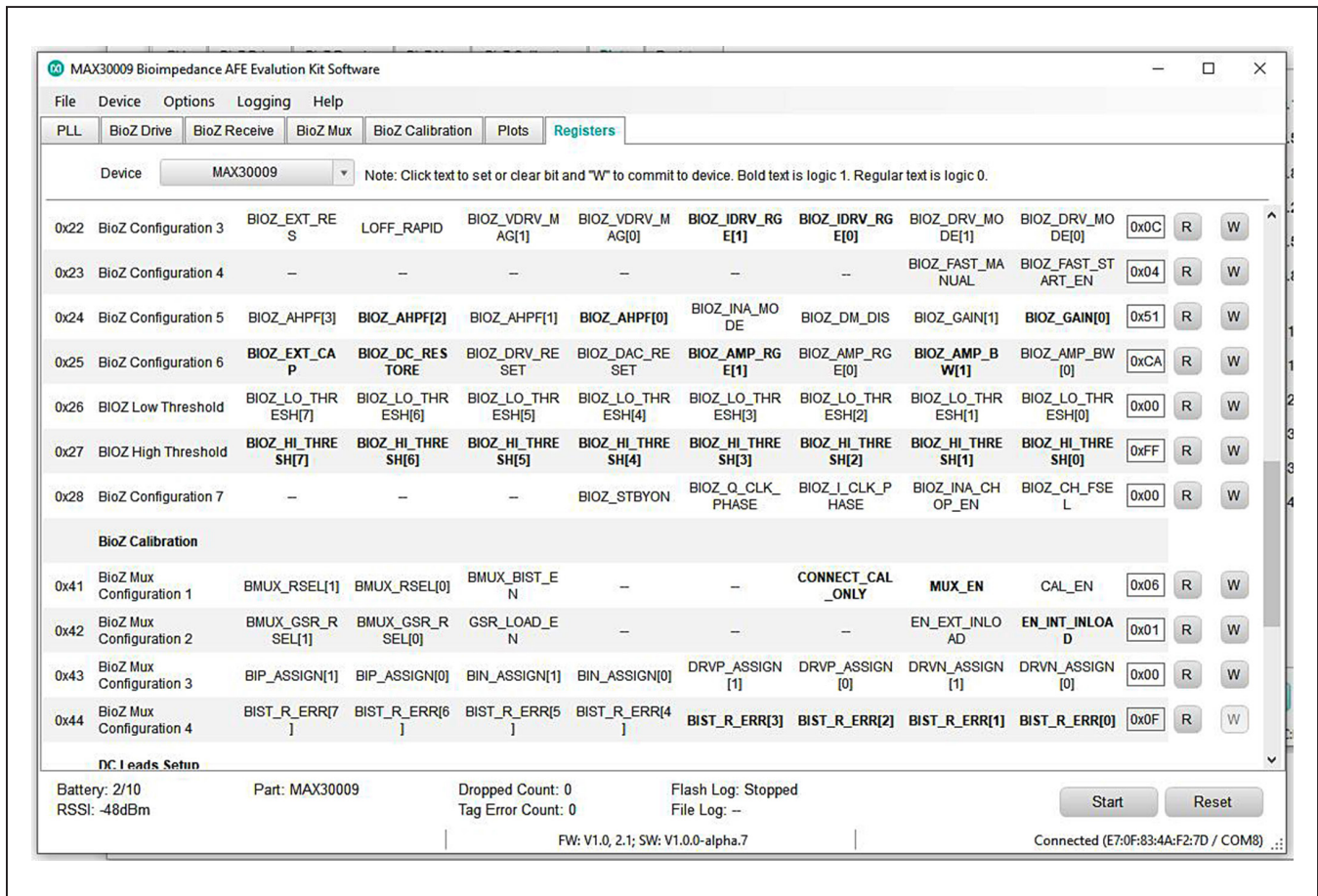

Figure 12. MAX30009EVKIT# EV Kit Registers tab

MAX30009EVKIT# Evaluation Kit

Evaluates: MAX30009

The EV kit can be disconnected and powered by the Li-Po battery during flash logging, allowing for remote operation. Note that clearing the existing flash memory can take up to 30 seconds after **Flash** is selected. A flashing yellow status LED indicates that flash logging has begun. If flash memory fills or battery power drops too low, flash logging will automatically stop, and the file will close.

The file must be downloaded as it will be erased from flash memory on the next log request. If a log has completed, a binary file will be found on the EV kit. To download the binary file, connect the EV kit to the

PC using the USB-C to USB-A cable. Open Windows Explorer, locate the “**MAXIM MSD X**” mass storage device, and copy the binary file from the EVKIT onto the PC. Select the **Parse Bin File** in the **Logging Menu** to open the **Parser Configuration Window** and parse the binary file into a “.csv” file, as shown in [Figure 13](#). Once completed, the **Parser Completed Messaged Window** will appear, as shown in [Figure 14](#).

Note: The max duration for flash logging is dependent on the BioZ sample rate and number of enabled channels.

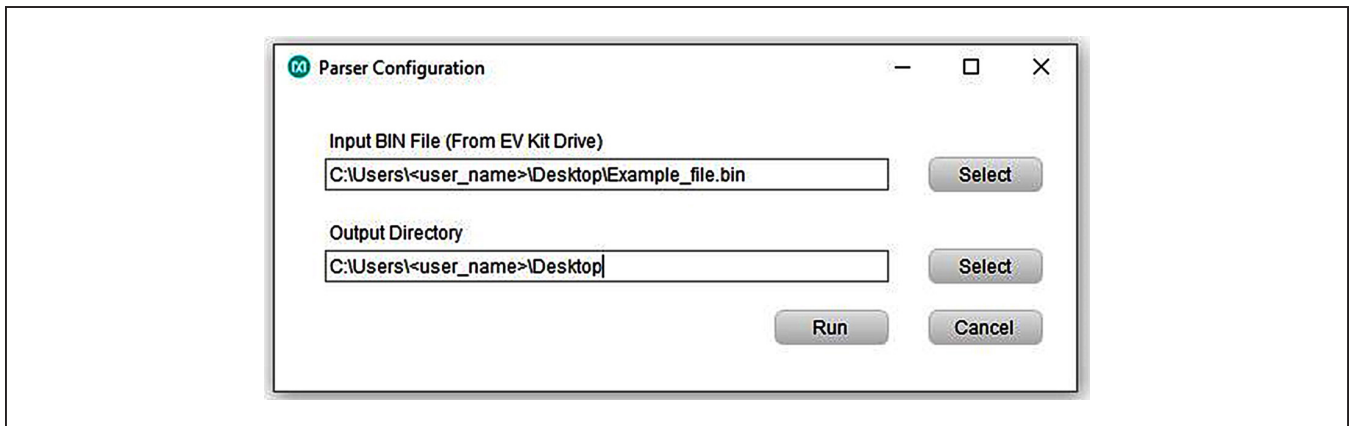

Figure 13. Parser Configuration window

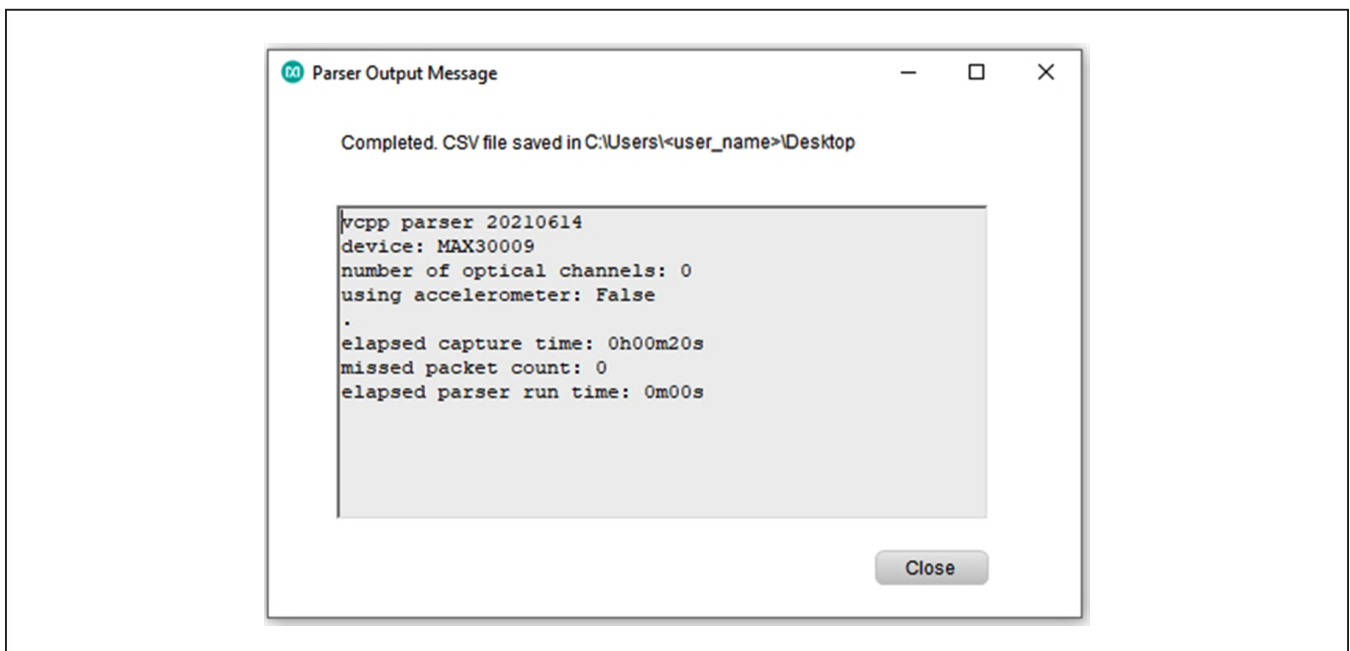

Figure 14. Parser Completed Message Window

Output File Format

The Output File Format describes the output “.csv” file format for BioZ measurements. Rows 1-4 contain register values. Row 5 contains the start time in milliseconds. Row 6 is a column header denoting the timestamp in milliseconds, sample number, BIOZI, BIOZQ, temperature, RTC, statusCache1, statusCache0, sensor, regAddr, val, and I2Caddr. The rows below contain rows of data corresponding to the column headers. Finally, the rows below the rows of data show stop time, elapsed capture time, and missed packet count. See [Figure 15](#) for an example.

Detailed Description of Hardware

Status LED Indicators

The following tri-color LEDs on the MAXSENSORBLE_EVKIT_B are used as status indicators. See [Figure 16](#).

Green/Red Status LED: Green

- Toggling (1Hz 50% duty cycle) = BLE is advertising
- Toggling (1Hz 10% duty cycle) = BLE is connected

Green/Red Status LED: Red

- USB-C cable is connected to charger
- On = charging
- Off = charge complete

Flash Logging LED

- On = busy preparing the flash memory or flash memory is full
- Toggling (synchronously with the green LED) = logging
- Off = not logging

Note: The flash logging indication takes precedence over the charging indication. (i.e., if the EV kit is plugged into a charger, the red LED indicates charge status). If flash logging is enabled while plugged into the charger, the red LED indicates flash log status.

	A	B	C	D	E	F	G	H	I	J	K	L	M	N	O	P	Q	R	S	
1	MAX30005	MAX30005	MAX30005	MAX30005	MAX30005	MAX30005	MAX30005	MAX30005	MAX30005	MAX30005	MAX30005	MAX30005	MAX30005	MAX30005	MAX30005	MAX30005	MAX30005	MAX30005	MAX30005	MAX30009reg0x50
2	MAX30005	MAX30005	MAX30005	MAX30005	0	0	accelID	fileParseI	0	0	RTCpreSc	WallClock	WallClock	WallClock	WallClock	UseAcc	WallClock	WallClock	B4	
3	0x43	0xff	0x01	0x60	0xef	0x00	0x18	0x04	0x51	0xca	0x00	0xff	0x00	0x02	0x01	0x00	0x0e	0x00		
4	0x00	0x04	0x01	0x42	0x00	0x00	0x00	0x00	0x00	0x00	0x1f	0x9d	0x51	0x71	0xb8	0x00	0x01	0x7b		
5	start time	1.63E+12																		
6	timestamp	sampleNu	BIOZI	BIOZQ	temperati	RTC	statusCac1	statusCac0	sensor	regAddr	val	I2Caddr								
7	1.63E+12	1	22118	-14799																
8	1.63E+12	2	55179	-160211																
9	1.63E+12	3	64365	-218743																
10	1.63E+12	4	60626	-233784																
11	1.63E+12	5	61826	-246965																
12	1.63E+12	6	73551	-237921																
13	1.63E+12	7	47019	-232869																
14	1.63E+12	8	41423	-261330																
15	1.63E+12	9	37212	-275901																
16	1.63E+12	10	34231	-280473																

Figure 15. Output .csv file example for BioZ measurements (First few rows)

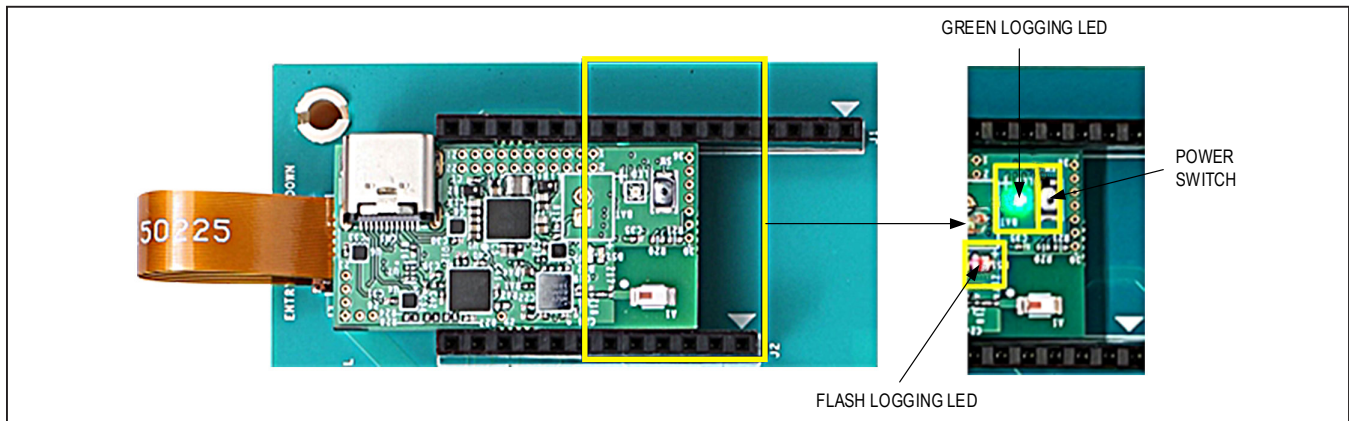

Figure 16. Location of Power Switch, Status LED and Flash Logging LED

Powering the EV kit

To turn on the EV kit, press and hold the power switch (SW) for 1 second until the green LED starts flashing. See [Figure 16](#). When powered on, the green status indicator LED will toggle as described in the [Status LED Indicators](#) section of this datasheet. To turn off the EV kit, press and hold the power switch for 3 seconds until the green LED stops flashing. When powered off, the green status indicator LED will go out. The red status indicator LED may light temporarily, indicating that the flash log is closing. Plugging in the USB-C to USB-A cable will also power up the EV kit. If the EV kit does not turn off after a 3-second hold, press and hold the power switch for 12 seconds to perform a forced shutdown.

Use the USB-C to USB-A cable to charge the integrated single-cell LiPo battery. The integrated PMIC initiates and stops charging automatically. Charge status is indicated through the red status indicator LED and GUI.

Configuring the Board for Measurement

The MAX30009EVKIT# EV kit offers custom connection and component configurations to enable testing of MAX30009 functionalities. The following sections detail these configurations. [Table 1](#) lists all jumpers and their respective functions. See the [MAX30009EVKIT# EV Kit Schematic Diagram](#) and [MAX30009EVKIT# EV Kit PCB Layout Diagrams](#) for more details.

SPI/I²C Configurations

The MAX30009 supports both SPI and I²C serial interfaces. However, the provided firmware and GUI only support SPI and do not support I²C. If the user prefers

to use I²C, there are instructions on the board and on the schematic for 0Ω resistors to depopulate/populate to change over from SPI to I²C. In addition, the LSB of the I²C address must be selected using jumper J11. See the [MAX30009EVKIT# EV Kit Schematic Diagram](#) for more details.

BioZ Configurations

The MAX30009 offers several configurations to enable a variety of tests and applications of BioZ functionalities. Capacitors C5, C6, C7, and C8 are coupling capacitors of values 47nF that block DC current from being driven into the patient when the current stimulus is used. Jumpers J6, J4, J7, and J8 can be used to bypass these capacitors (see [Table 1](#)).

When voltage stimulus or H-bridge stimulus is used, capacitors C5 and C6 need to be replaced by surface mount series resistors (0402 package) to limit current from the source. See the [Sine-Wave Voltage Stimulus](#) or [Square-Wave Voltage \(H-Bridge\) Stimulus](#) sections of the MAX30009 datasheet for information on choosing the proper resistor value. Do not use jumpers J6 and J8 when current limit resistors are loaded in locations C5 and C6.

External Oscillator

The MAX30009 contains its own internal 32.768kHz and 32kHz silicon oscillators. The board also has a low-jitter 32.768kHz oscillator that is connected to the FCLK pin of the device, which provides better frequency accuracy than the MAX30009's internal oscillators. If the user wants to use some other clock source, resistor R11 can be removed and a wire can be connected to TP10 on the board.

Table 1. Description of Jumpers

JUMPER	SHUNT POSITION	DESCRIPTION
J5	1-2	Connects EL1 (DRVP) to EL2B (BIP) for bipolar measurement
J9	1-2	Connects EL4 (DRVN) to EL3B (BIN) for bipolar measurement
J6	1-2	Bypasses DC blocking capacitor on EL1 (DRVP)
J4	1-2	Bypasses DC blocking capacitor on EL2B (BIP)
J7	1-2	Bypasses DC blocking capacitor on EL3B (BIN)
J8	1-2	Bypasses DC blocking capacitor on EL4 (DRVN)
J11	1-2*	Selects I ² C address 1 during I ² C mode
	2-3	Selects I ² C address 0 during I ² C mode

*Default shunt position

Upgrading firmware

In case the MAXSENSORBLE_EVKIT_B board firmware needs to be upgraded, Use the following procedure below to properly flash the firmware:

- 1) See [Figure 17](#) for the following step. Power down the MAXSENSORBLE_EVKIT_B board. Connect the MAXSENSORBLE_EVKIT_B board to the MAXDAP-TYPE-C programmer board. Ensure that the label "MAXDAP-TYPE-C" is on the same side as the top of the MAXSENSORBLE_EVKIT_B board, as Type USB-C direction matters. Connect the micro USB-B to USB-A cable to your PC via HDK USB port on the MAXDAP-TYPE-C board. After the cable is connected to your PC, the MAXSENSORBLE_EVKIT_B board will power up and have red & yellow status indicator LEDs on. Do not press the power button at this time!
- 2) Unzip the **MAX30009_mcu flashtools.7z**. In the unzipped folder, double click the file **erase+flash_**

nrf52.bat. Note: Do not only copy the .bat file to any other folder, as the .bat file requires support from the files in this folder.

- 3) A **command prompt** should pop up when the .bat file is opened. Follow instructions provided in the command prompt to finish flashing the firmware. If the command prompt shows **Verified Okay**, the firmware has been successfully flashed on the MAXSENSORBLE_EVKIT_B board, as shown in [Figure 18](#).
- 4) Once finished, unplug the **MAXDAP-TYPE-C** from the MAXSENSORBLE_EVKIT_B board. Press the power button on the MAXSENSORBLE_EVKIT_B until all the LEDs turn off – this will typically take 10 to 20 seconds. If no LEDs are lit, you must still hold press and hold the power button for 20 seconds. Now the MAXSENSORBLE_EVKIT_B is ready to be used and can be powered up. The firmware version can be read in the Status window of the GUI.

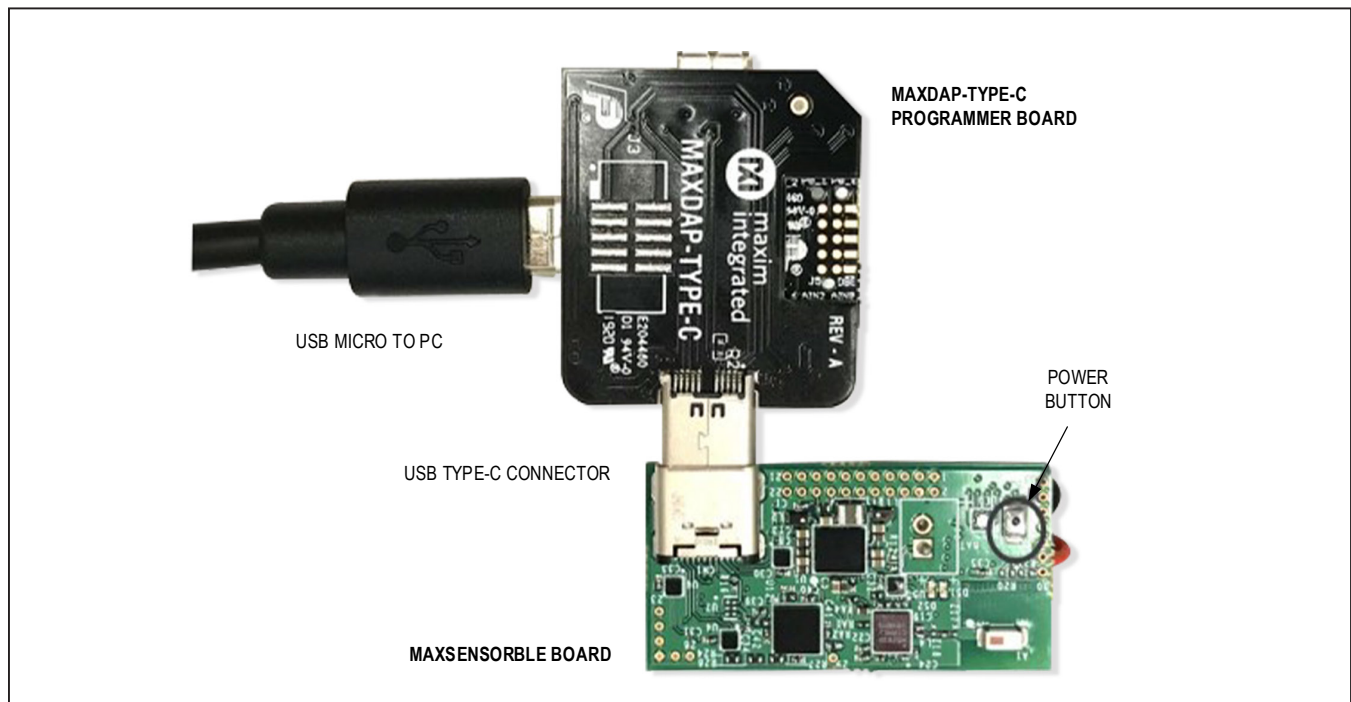

Figure 17. Connections to flash firmware on MAXSENSORBLE_EVKIT_B board.

```

Warn : using fast async flash loader. This is currently supported
Warn : only with ST-Link and CMSIS-DAP. If you have issues, add
Warn : "set WORKAREASIZE 0" before sourcing nrf51.cfg to disable it
wrote 524524 bytes from file os61_nrf52_full_v0.0.hex in 47.363514s (10.815 KiB/s)
** Programming Finished **
** Verify Started **
verified 162280 bytes in 1.784870s (88.789 KiB/s)
** Verified OK **
shutdown command invoked

C:\00_D\86171_OS61\OS61 EVSYS\Flash MCU-1104\os61_mcu_flashtools_20180617\os61_mcu_flashtools_20180617>pause
Press any key to continue . . .

```

Figure 18. Command prompt display when firmware has successfully been flashed.

Component List

PART	QTY	DESCRIPTION
MAXSENSORBLE_EVKIT_B	1	MAX30009EVKIT# EV kit Data Acquisition Board
MAX30009_EVKIT_B	1	MAX30009 Evaluation Board
101181XX-000XXX	1	USB-C to USB-A Cable, 3ft.
LP-401320	1	105mAh LiPo battery
MAXDAP-TYPE-C	1	Programmer board
AK67421-1-r 2 USB 2.0	1	USB-A to micro USB-B cable

Note: Indicate that you are using MAX30009EVKIT# EV kit when contacting these component suppliers.

Ordering Information

PART	TYPE
MAX30009EVKIT#	EV Kit

#Denotes RoHS compliant.

MAX3009EVKIT# Evaluation Kit

Evaluates: MAX3009

MAX3009 EV Kit Bill of Materials MAXSENSORBLE_EVKIT_B

ITEM	REF_DES	DNI/DNP	QTY	MFG PART #	MANUFACTURER	VALUE	DESCRIPTION	COMMENTS
1	A1	-	1	2450AT18A100	JOHANSON TECHNOLOGY	2450AT18A100	ANTENNA; 2450AT SERIES; BOARDMOUNT; MINI 2.45 GHZ ANTENNA; 2450MHZ	
2	BAT	-	1	B2B-PH-K-S(LF)(SN)	JST MANUFACTURING	B2B-PH-K-S(LF)(SN)	CONNECTOR; MALE; THROUGH HOLE; PH CONNECTOR; 2MM PITCH; SHROUDED HEADER; STRAIGHT; 2PINS	
3	C1, C22, C26, C30-C37	-	11	GRM033R61A104KE15; LMK063BJ104KP	MURATA;TAIYO YUDEN	0.1UF	CAPACITOR; SMT (0201); CERAMIC CHIP; 0.1UF; 10V; TOL=10%; MODEL=; TG=-55 DEGC TO +125 DEGC; TC=X5R	
4	C2, C15, C25, C38-C43	-	9	GRM033R61A105ME15	MURATA	1UF	CAPACITOR; SMT (0201); CERAMIC CHIP; 1UF; 10V; TOL=20%; TG=-55 DEGC TO +85 DEGC; TC=X5R	
5	C3, C4, C8, C9, C12, C16, C27	-	7	ZRB15XR61A475ME01; CL05A475MP5NRN; GRM155R61A475MEAA; C1005X9R1A475M050BC	MURATA;SAMSUNG;MURATA;TDK	4.7UF	CAPACITOR; SMT (0402); CERAMIC CHIP; 4.7UF; 10V; TOL=20%; TG=-55 DEGC TO +85 DEGC; TC=X5R	
6	C5-C7, C10, C13, C14, C47	-	7	GRM155R60J226ME11	MURATA	22UF	CAPACITOR; SMT (0402); CERAMIC CHIP; 22UF; 6.3V; TOL=20%; TC=X5R	
7	C19	-	1	GJM0335C1E1R0WB01	MURATA	1PF	CAPACITOR; SMT (0201); CERAMIC CHIP; 1PF; 25V; TOL=0.05PF; TG=-55 DEGC TO +125 DEGC; TC=C0G	
8	C20, C21, C28, C29, C45, C46, Z44	-	7	GRM0335C1H120GA01	MURATA	12PF	CAPACITOR; SMT (0201); CERAMIC CHIP; 12PF; 50V; TOL=2%; TG=-55 DEGC TO +125 DEGC; TC=C0G	
9	C23, C24	-	2	GRM0335C1H101JA01	MURATA	100PF	CAPACITOR; SMT (0201); CERAMIC CHIP; 100PF; 50V; TOL=5%; TG=-55 DEGC TO +125 DEGC; TC=C0G	
10	CN1	-	1	DX07S024JJ3R1300	JAE ELECTRONIC INDUSTRY	DX07S024JJ3	CONNECTOR; FEMALE; SMT; USB TYPE-C CONNECTOR; DX07 SERIES RECEPTACLE; RIGHT ANGLE; 24PINS	
11	DS1, DS2	-	2	SML-P11UTT86	ROHM	SML-P11UTT86	DIODE; LED; SMT; PIV=1.8V; IF=0.02A	
12	J3	-	1	5035662500	MOLEX	5035662500	CONNECTOR; FEMALE; SMT; EASY-ON TYPE HOUSING ASSEMBLY; RIGHT ANGLE; 25PINS	
13	L1, L2	-	2	DFE18SBN2R2MELL	MURATA	2.2UH	EVKIT PART - INDUCTOR; SMT (0603); SHIELDED; 2.2UH; 20%; 1.2A	
14	L3	-	1	DFE201610E-4R7M-P2	MURATA	4.7UH	INDUCTOR; SMT (2016); METAL ALLOY CHIP; 4.7UH; TOL=+-20%; 1.3A	
15	L4	-	1	LQP03HQ3N3B02	MURATA	3.3NH	INDUCTOR; SMT (0201); FILM TYPE; 3.3NH; TOL=+-0.1nH; 0.5A	
16	LED	-	1	SML-LX0404SIUPGUSB	LUMEX OPTOCOMPONENTS INC	SML-LX0404SIUPGUSB	DIODE; LED; SML; FULL COLOR; WATER CLEAR LENS; RED-GREEN-BLUE; SMT; VF=2.95V; IF=0.1A	
17	R2, R3, R11, R15, R24, R27-R31, R34	-	11	ERJ-2GE0R00	PANASONIC	0	RESISTOR; 0402; 0 OHM; 0%; JUMPER; 0.10W; THICK FILM	
18	R5, R9	-	2	ERJ-1GEF1002	PANASONIC	10K	RESISTOR; 0201; 10K OHM; 1%; 200PPM; 0.05W; THICK FILM	
19	R6, R7, R16, R17, R23, R25, R26	-	7	ERJ-1GEF4701C	PANASONIC	4.7K	RESISTOR; 0201; 4.7K OHM; 1%; 100PPM; 0.05W; THICK FILM 3-LAYER ELECTRODE	
20	R8	-	1	ERJ-1GEF3902	PANASONIC	39K	RESISTOR; 0201; 39K OHM; 1%; 100PPM; 0.05W; THICK FILM 3-LAYER ELECTRODE	
21	R10	-	1	NCP15XH103F03	MURATA	10K	THERMISTOR; SMT (0402); THICK FILM (NICKEL PLATED); 10K; TOL=+-1%	
22	R13	-	1	ERJ-1GEF2613C	PANASONIC	261K	RESISTOR; 0201; 261K OHM; 1%; 200PPM; 0.05W; THICK FILM	
23	R14	-	1	CRCW0201100KFK	VISHAY DALE	100K	RESISTOR; 0201; 100K OHM; 1%; 100PPM; 0.05W; THICK FILM	
24	R18, R19	-	2	ERJ-1GEF2000C	PANASONIC	200	RESISTOR; 0201; 200 OHM; 1%; 200PPM; 0.05W; THICK FILM	
25	RA1-RA4	-	4	ERJ-1GEF33R0C	PANASONIC	33	RESISTOR; 0201; 33 OHM; 1%; 100PPM; 0.05W; THICK FILM 3-LAYER ELECTRODE	
26	SW	-	1	EVP-AWCD2A	PANASONIC	EVP-AWCD2A	SWITCH; SPST; SMT; STRAIGHT; 15V; 0.02A; EVP-AW SERIES	
27	U1	-	1	MAX20303KEWN+	ANALOG DEVICES	MAX20303KEWN+	EVKIT PART- IC; WEARABLE POWER NAMAGEMENT SOLUTION; PACKAGE OUTLINE; WLP 56 PINS; 0.5MM PITCH; PKG. CODE: W563A4+1; PKG. OUTLINE: 21-100104	
28	U2	-	1	NRF52832-CIAA	NORDIC SEMICONDUCTOR	NRF52832-CIAA	IC; SOC; MULTIPROTOCOL BLUETOOTH LOW ENERGY; ANT; 2.4GHZ RF SOC; WLCPSP50	
29	U3-U6, U9	-	5	MAX14689EWL+	ANALOG DEVICES	MAX14689EWL+	IC; ASW; 0.125A; FREQUENCY-SELECTSBLE; SWITCHED-CAPACITOR VOLTAGE CONVERTER; WLP9 1.2X1.2	
30	U7	-	1	IP4221C26-S	NXP	IP4221C26-S	IC; PROT; ESD PROTECTION FOR HIGH-SPEED INTERFACE; XSON6	
31	U8	-	1	S25FS256SAGNF1001	SPANSION	S25FS256SAGNF1001	IC; MMRY; MIRRORBIT FLASH; NON-VOLATILE MEMORY; 1.8V SINGLE SUPPLY WITH CMOS I/O; SERIAL PERIPHERAL INTERFACE WITH MULTI-I/O; WSON8-EP	
32	U10, U11	-	2	MAX9062EBS+G45	ANALOG DEVICES	MAX9062EBS+G45	IC; COMP; ULTRA-SMALL; LOW-POWER SINGLE COMPARTOR; UCSP4	
33	U12	-	1	MAX32620IWG+	ANALOG DEVICES	MAX32620IWG+	IC; UCON; HIGH-PERFORMANCE; ULTRA-LOW POWER CORTEX-M4F MICROCONTROLLER FOR RECHARGEABLE DEVICES; WLP81	
34	U13	-	1	74AUP1G97GF	NXP	74AUP1G97GF	IC; LOGC; LOW-POWER CONFIGURABLE MULTIPLE FUNCTION GATE; XSON6	
35	U29	-	1	MAX1819EBL33+	ANALOG DEVICES	MAX1819EBL33+	IC; VREG; 500MA LOW-DROPOUT LINEAR REGULATOR IN UCSP; UCSP6	
36	X2, Y2	-	2	ECS-.327-6-12	ECS INC	32.768KHZ	CRYSTAL; SMT 2.0 MM X 1.2 MM; 6PF; 32.768KHZ; +/-20PPM; -0.03PPM/DEGC2	
37	Y1	-	1	US3200005Z	PERICOM SEMICONDUCTOR	32MHZ	CRYSTAL; SMT 1.6 MM X 1.2MM; 8PF; 32MHZ; +/-10PPM; +/-10PPM	
38	PCB	-	1	MAXSENSORBLE	ANALOG DEVICES	PCB	PCB;MAXSENSORBLE	
39	MISC1	DNI	1	101181XX-000XXX	N/A	101181XX-000XXX	CONNECTOR; MALE; PALETTE SERIES 3.0 USB-C TO USB-A; 3FT BLACK	
40	R1, R4, R12, R20-R22, R32, R33	DNP	0	ERJ-2GE0R00	PANASONIC	0	RESISTOR; 0402; 0 OHM; 0%; JUMPER; 0.10W; THICK FILM	
41	Z17	DNP	0	GJM0335C1E1R0WB01	MURATA	1PF	CAPACITOR; SMT (0201); CERAMIC CHIP; 1PF; 25V; TOL=0.05PF; TG=-55 DEGC TO +125 DEGC; TC=C0G	
42	Z18	DNP	0	250R05L1R8AV4	JOHANSON TECHNOLOGY	1.8PF	CAPACITOR; SMT (0201); MICROWAVE; 1.8PF; 25V; TOL=0.05PF; TG=-55 DEGC TO +125 DEGC; TC=C0G	
43		Jan-36	0	N/A	N/A	N/A	TEST POINT; PAD DIA=0.762MM; BOARD HOLE=0.381MM	
TOTAL			105					

MAX3009EVKIT# Evaluation Kit

Evaluates: MAX3009

MAX3009 EV Kit Bill of Materials

MAX3009EVKIT#

ITEM	REF_DES	DNI	QTY	MFG PART #	MANUFACTURER	VALUE	DESCRIPTION
1	C5-C8, C14	—	5	C1005X7R1E473K050BC; GRM155R71E473K; GCM155R71E473KA55	TDK; MURATA; MURATA	0.047UF	CAP; SMT (0402); 0.047UF; 10%; 25V; X7R; CERAMIC
2	C9	—	1	C0402C105K8PAC; CC0402KRX5R6BB105	KEMET; YAGEO	1UF	CAP; SMT (0402); 1UF; 10%; 10V; X5R; CERAMIC
3	C10, C11	—	2	GRM155R61A106ME44; GRM155R61A106ME11; 0402ZD106MAT2A; CL05A106MP5NUNC	MURATA; MURATA; AVX; SAMSUNG	10UF	CAP; SMT (0402); 10UF; 20%; 10V; X5R; CERAMIC
4	C12, C13	—	2	C0201C104K9PAC; GRM033R60J104KE19; C0603X5R0J104K030BC; C0201X5R6R3-104KNP	KEMET; MURATA; VENKEL; TDK	0.1UF	CAP; SMT (0201); 0.1UF; 10%; 6.3V; X5R; CERAMIC
5	J1	—	1	PPPC161LFBN-RC	SULLINS ELECTRONICS CORP.	PPPC161LFBN-RC	CONNECTOR; FEMALE; THROUGH HOLE; LFB SERIES; 2.54MM CONTACT CENTER; STRAIGHT; 16PINS
6	J2	—	1	PPPC121LFBN-RC	SULLINS ELECTRONICS CORP	PPPC121LFBN-RC	CONNECTOR; FEMALE; THROUGH HOLE; HEADER FEMALE; STRAIGHT; 12PINS
7	J3	—	1	FH26W-25S-0.3SHW(60)	HIROSE ELECTRIC CO. LTD.	FH26W-25S-0.3SHW(60)	CONNECTOR; FEMALE; SMT; FPC CONNECTOR; RIGHT ANGLE; 25PINS
8	J4-J9	—	6	PCC02SAAN	SULLINS	PCC02SAAN	CONNECTOR; MALE; THROUGH HOLE; BREAKAWAY; STRAIGHT THROUGH; 2PINS; -65 DEGC TO +125 DEGC
9	J10	—	1	PPPC081LFBN-RC	SULLINS ELECTRONICS CORP	PPPC081LFBN-RC	CONNECTOR; FEMALE; THROUGH HOLE; 0.100INCH CONTACT CENTER 2.54MM FEMALE HEADER; STRAIGHT; 8PINS
10	J11	—	1	PCC03SAAN	SULLINS	PCC03SAAN	CONNECTOR; MALE; THROUGH HOLE; BREAKAWAY; STRAIGHT THROUGH; 3PINS; -65 DEGC TO +125 DEGC
11	J12-J14	—	3	PBC01SAAN	SULLINS ELECTRONICS CORP	PBC01SAAN	CONNECTOR; MALE; THROUGH HOLE; BREAKAWAY; STRAIGHT; 1PIN
12	J21-J24	—	4	41828-50	PLASTICS ONE	41828-50	CONNECTOR; FEMALE; THROUGH HOLE; JACK; PCB; 1.5MM; TOUCHPROOF WAVE SOLDER VERSION WITH STAMPING; RIGHT ANGLE; 3PINS
13	MH1-MH4	—	4	9032	KEYSTONE	9032	MACHINE FABRICATED; ROUND-THRU HOLE SPACER; NO THREAD; M3.5; 5/8IN; NYLON
14	R1A-R4A,R11	—	5	RC1608J000CS; CR0603-J-000ELF; RC0603JR-070RL	SAMSUNG ELECTRONICS; BOURNS; YAGEO PH	0	RES; SMT (0603); 0; 5%; JUMPER; 0.1000W
15	R5-R10	—	6	ERJ-2RKF1002	PANASONIC	10K	RES; SMT (0402); 10K; 1%; +/-100PPM/DEGC; 0.1000W
16	TP1-TP11	—	11	5011	KEYSTONE	N/A	TEST POINT; PIN DIA=0.125IN; TOTAL LENGTH=0.445IN; BOARD HOLE=0.063IN; BLACK; PHOSPHOR BRONZE WIRE SILVER PLATE FINISH;
17	U1	—	1	MAX3009ENA+	ANALOG DEVICES	MAX3009ENA+	EVKIT PART -IC; AFEC; LOW POWER; HIGH PERFORMANCE BIOIMPEDANCE AFE; WLP25
18	Y1	—	1	SIT1572AI-J3-18E-DCC-32.768	SITIME CORPORATION	SIT1572AI-J3-18E-DCC-32.768	OSCILLATOR; CSP 1.5 MM X 0.8 MM; 15PF; 32.768KHZ ; +/-10PPM
19	PCB	—	1	MAX3009	ANALOG DEVICES	PCB	PCB:MAX3009
20	R1B-R4B	DNI	0	ERJ-2GE0R00	PANASONIC	0	RES; SMT (0402); 0; JUMPER; JUMPER; 0.1000W
21	R13	DNI	0	ERJ-2GE0R00	PANASONIC	0	RES; SMT (0402); 0; JUMPER; JUMPER; 0.1000W

MAX3009EVKIT# Evaluation Kit

Evaluates: MAX3009

MAX3009 EV Kit Schematics MAXSENSORBLE_EVKIT_B

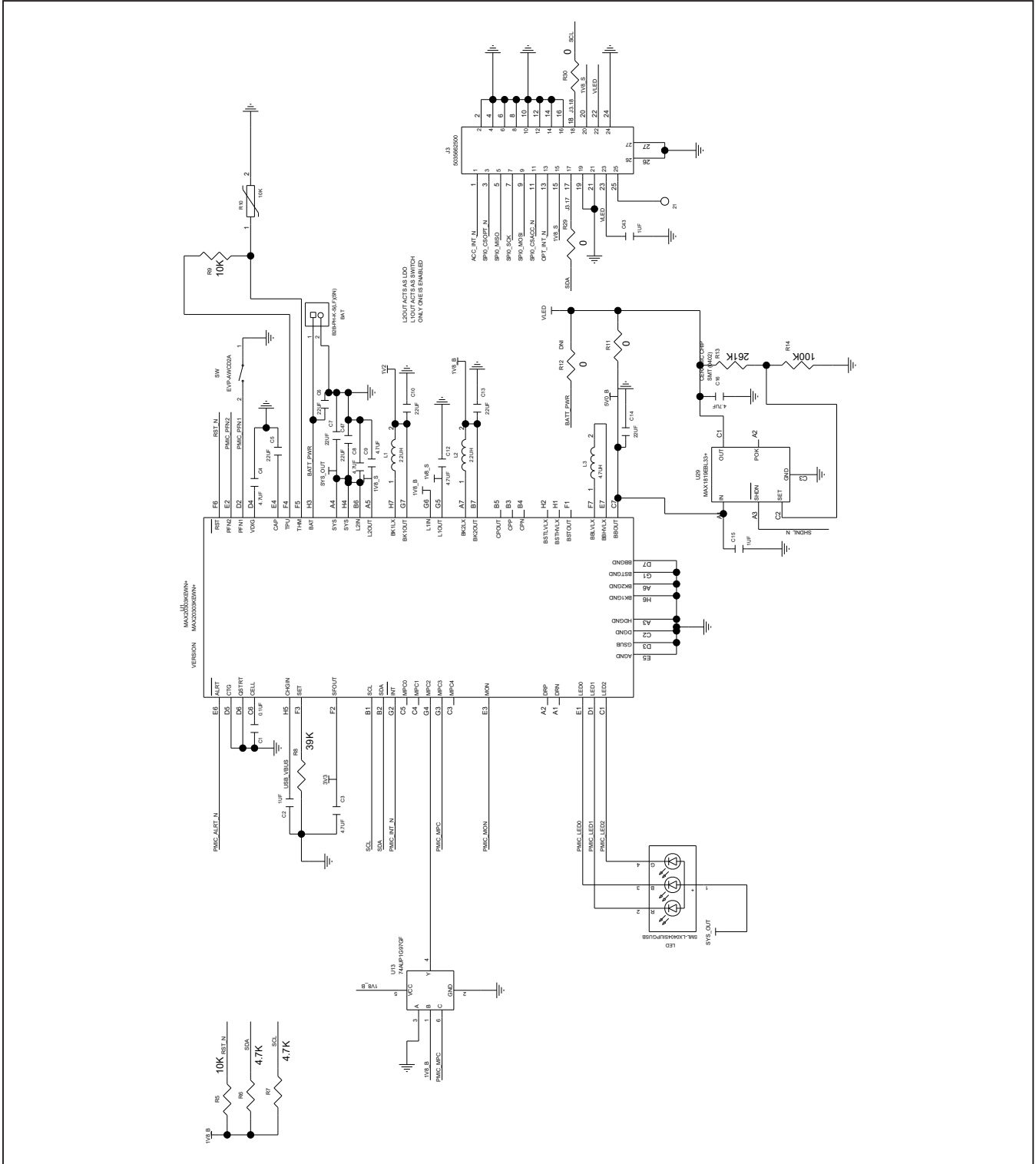

MAX3009EVKIT# Evaluation Kit

Evaluates: MAX3009

MAX3009 EV Kit Schematics (continued)

MAXSENSORBLE_EVKIT_B (continued)

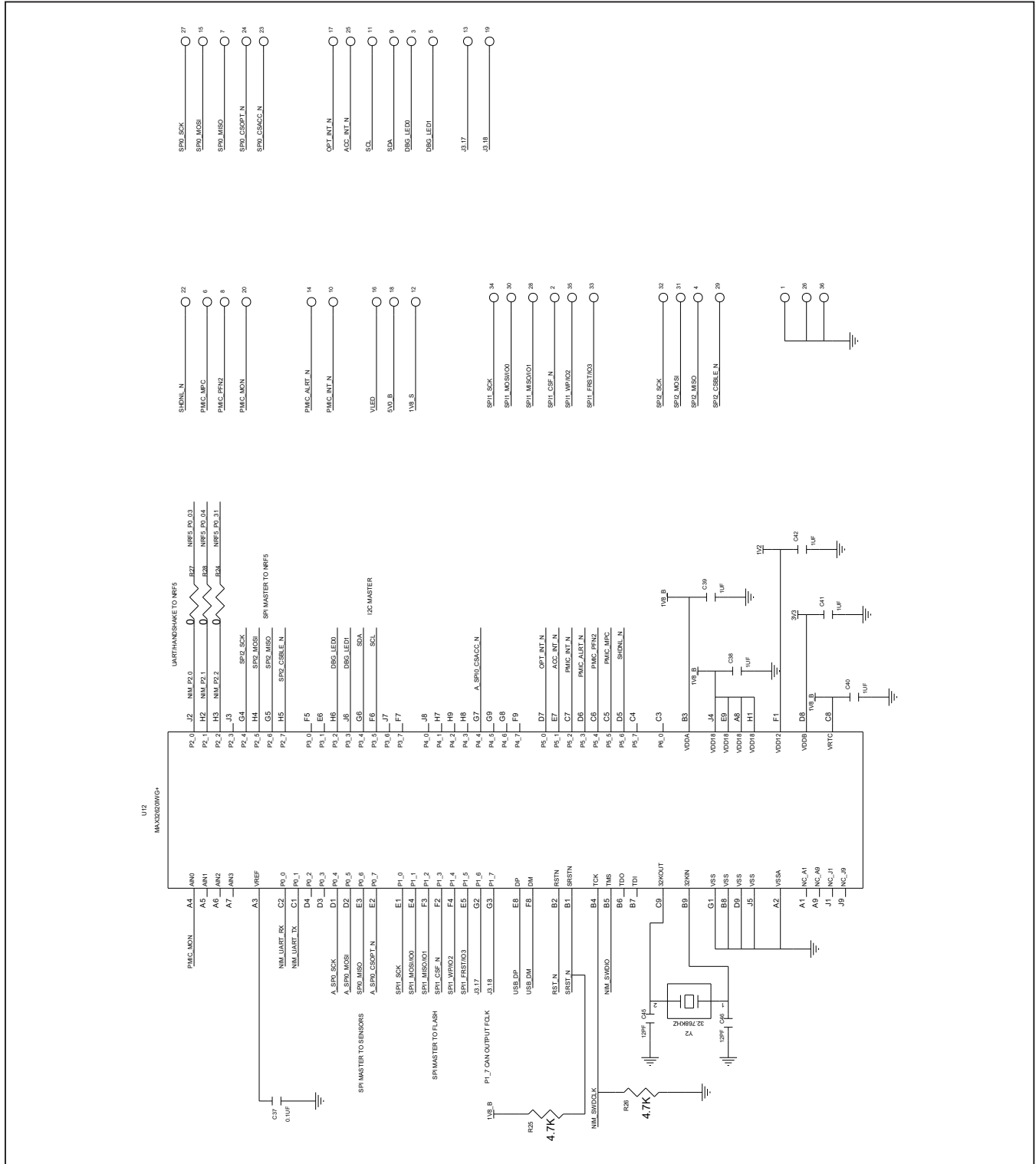

MAX30009EVKIT# Evaluation Kit

Evaluates: MAX30009

MAX30009 EV Kit PCB Layout diagrams MAXSENSORBLE_EVKIT_B

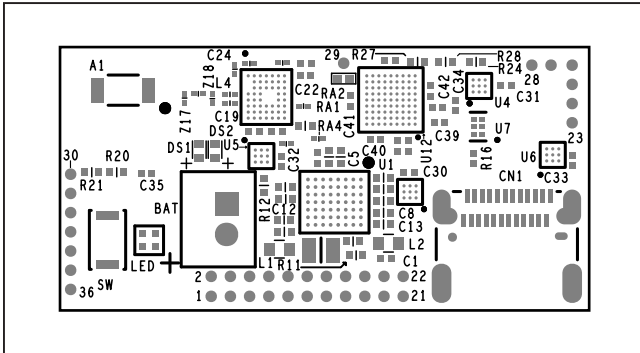

MAXSENSORBLE_EVKIT_B Component Placement Guide—
Top Silkscreen

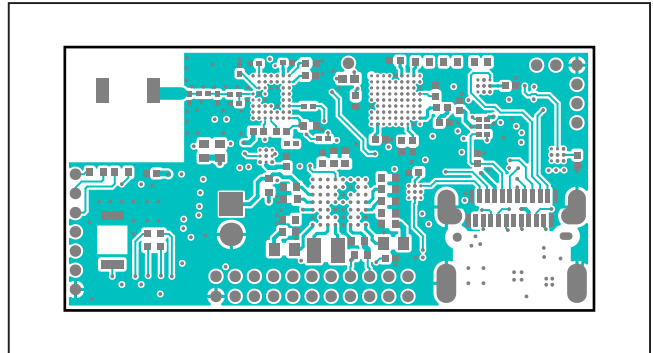

MAXSENSORBLE_EVKIT_B PCB Layout Diagrams—Top View

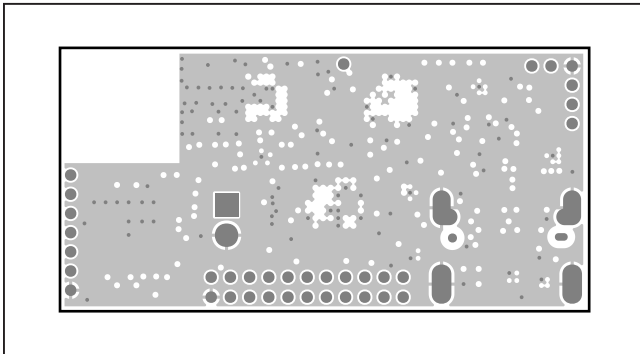

MAXSENSORBLE_EVKIT_B PCB Layout Diagrams—Internal 2

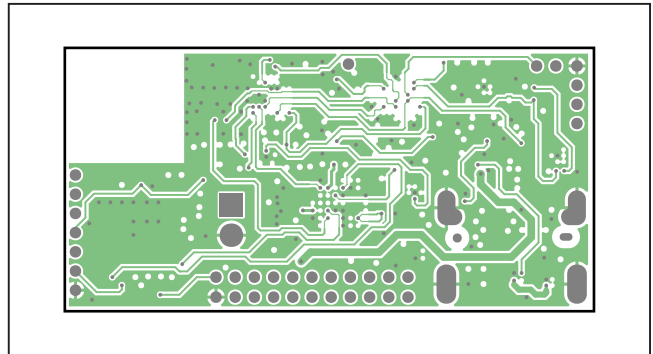

MAXSENSORBLE_EVKIT_B PCB Layout Diagrams—Internal 3

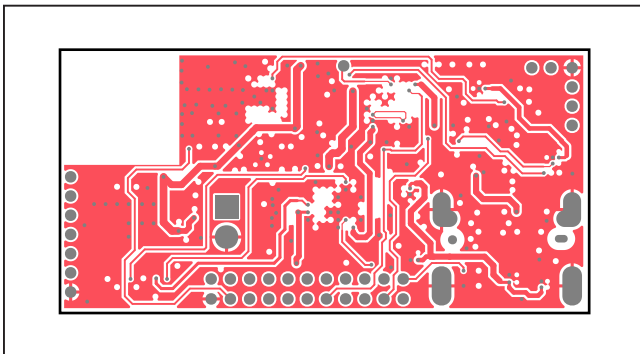

MAXSENSORBLE_EVKIT_B PCB Layout Diagrams—Internal 4

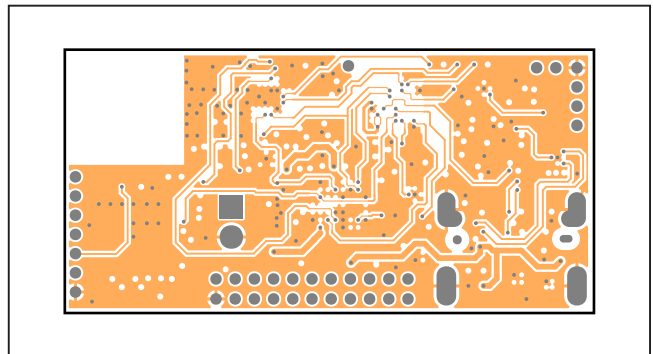

MAXSENSORBLE_EVKIT_B PCB Layout Diagrams—Internal 5

MAX30009 EV Kit PCB Layout diagrams (continued)

MAXSENSORBLE_EVKIT_B (continued)

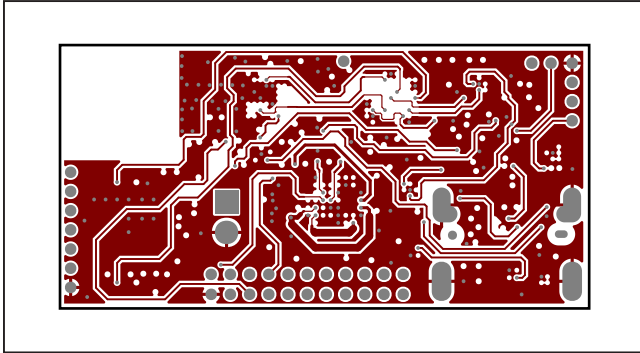

MAXSENSORBLE_EVKIT_B PCB Layout Diagrams—Internal 6

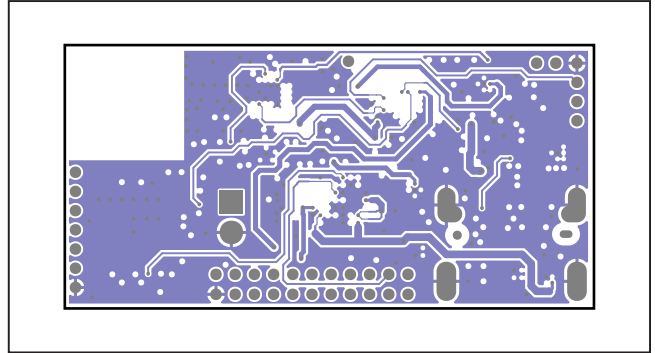

MAXSENSORBLE_EVKIT_B PCB Layout Diagrams—Internal 7

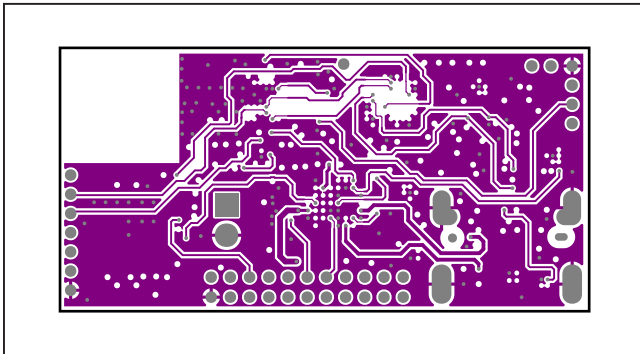

MAXSENSORBLE_EVKIT_B PCB Layout Diagrams—Internal 8

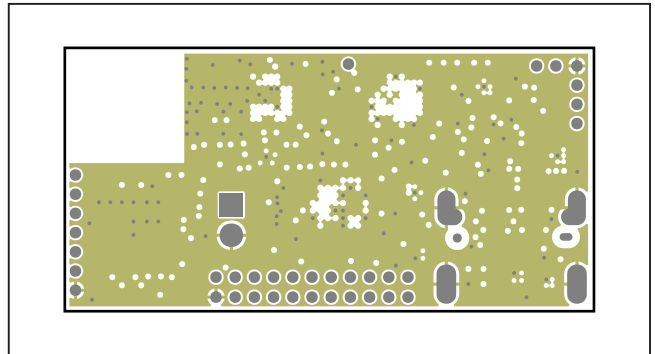

MAXSENSORBLE_EVKIT_B PCB Layout Diagrams—Internal 9

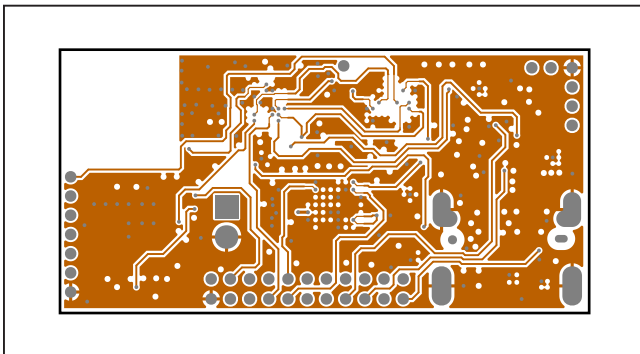

MAXSENSORBLE_EVKIT_B PCB Layout Diagrams—Internal 10

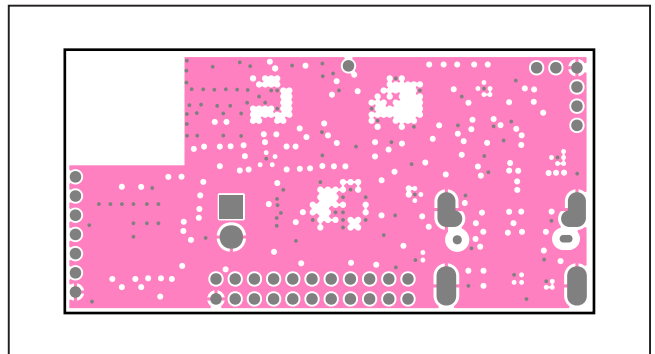

MAXSENSORBLE_EVKIT_B PCB Layout Diagrams—Internal 11

MAX30009 EV Kit PCB Layout Diagrams

MAX30009EVKIT#

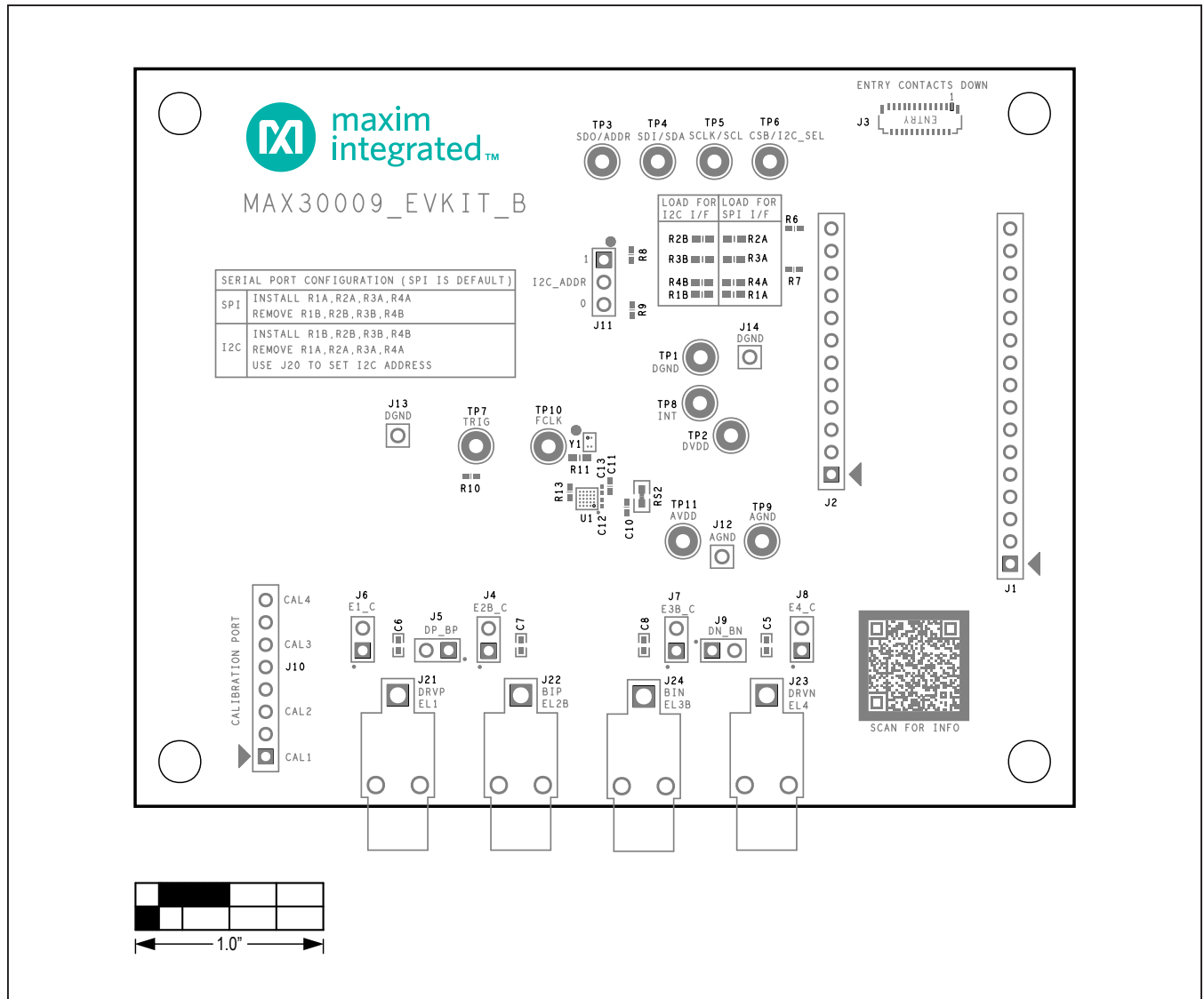

MAX30009EVKIT# EV Kit Component Placement Guide—Top Silkscreen

MAX30009 EV Kit PCB Layout Diagrams (continued)

MAX30009EVKIT# (continued)

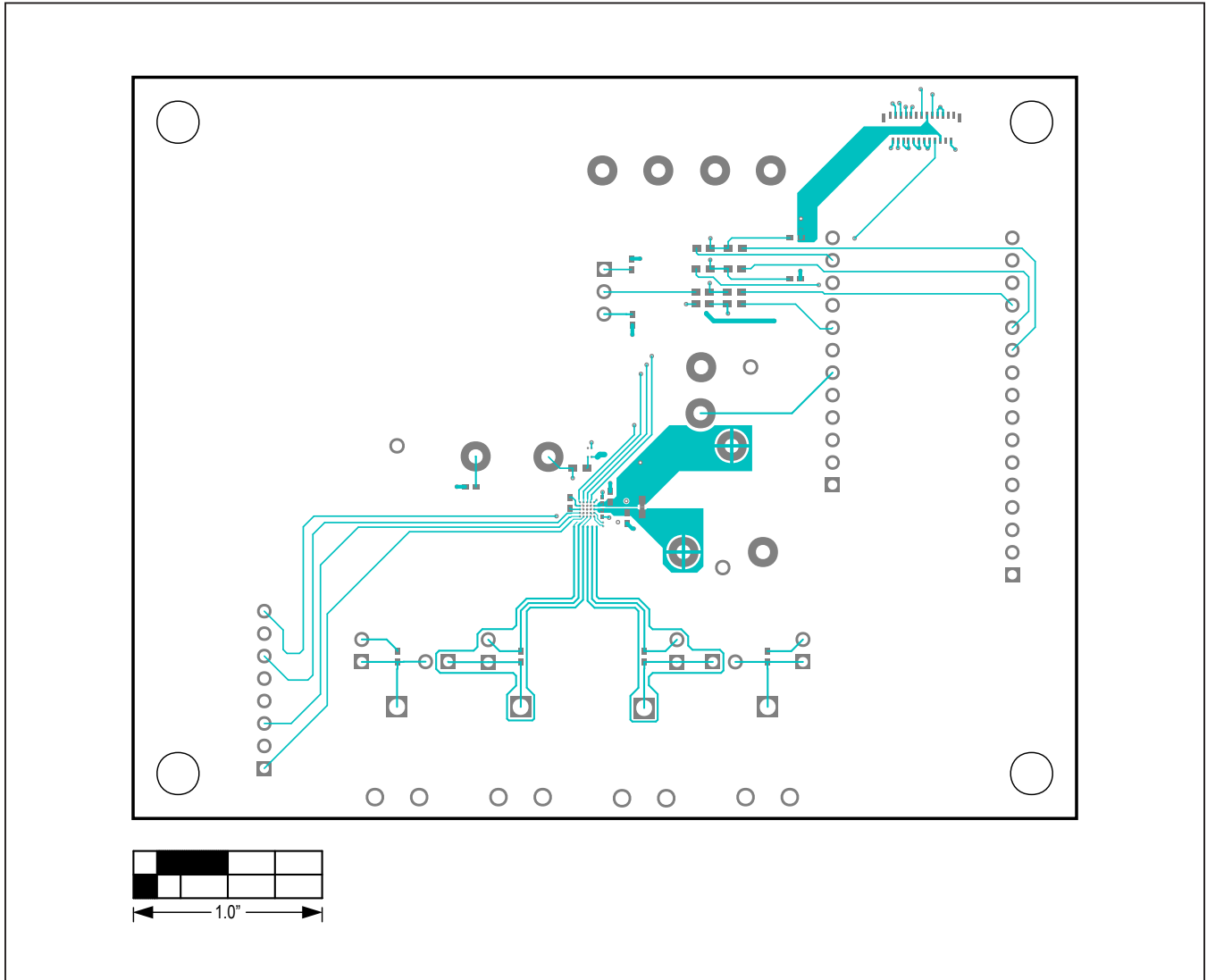

MAX30009EVKIT# EV Kit PCB Layout Diagrams—Top View

MAX30009 EV Kit PCB Layout Diagrams (continued)

MAX30009EVKIT# (continued)

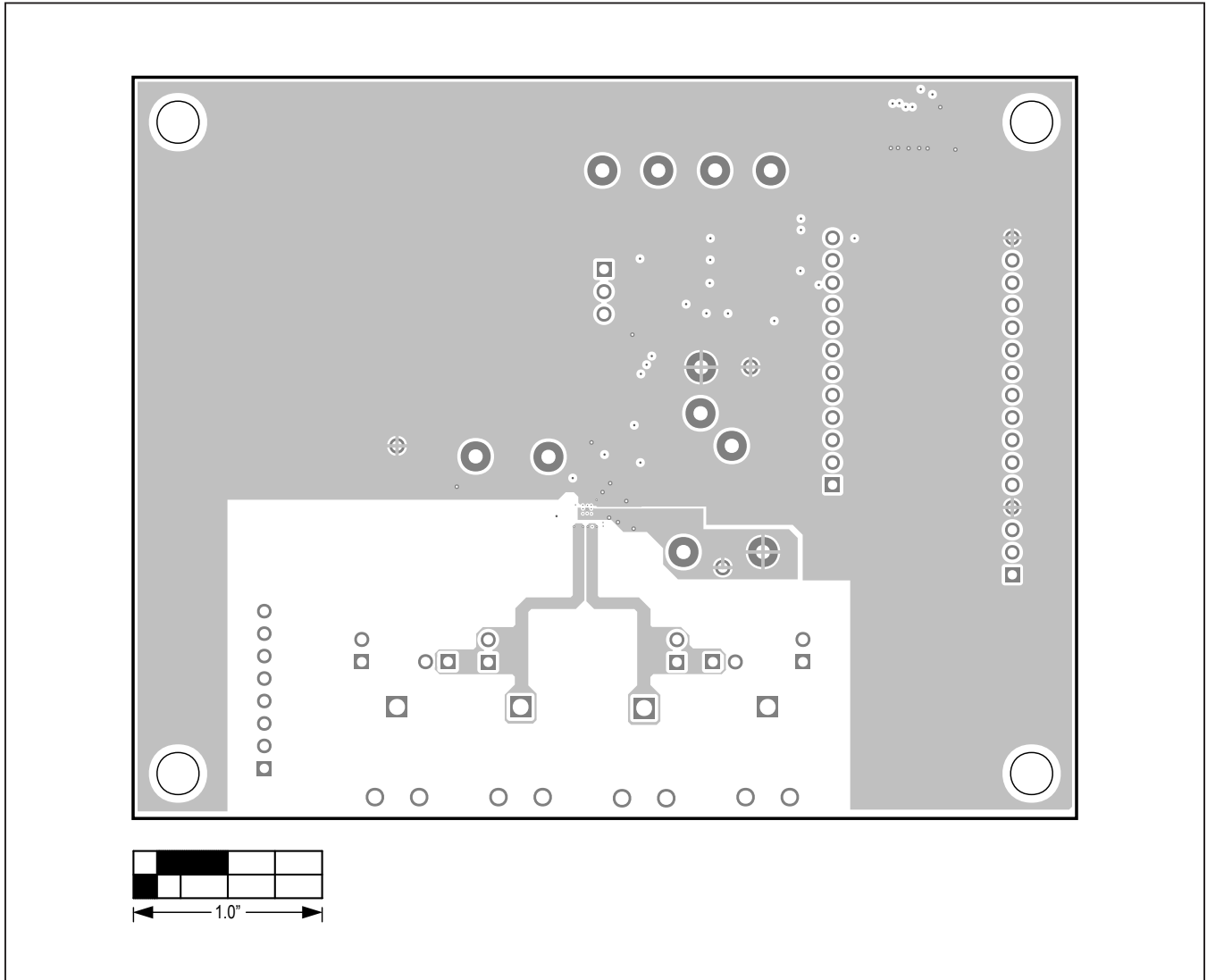

MAX30009EVKIT# EV Kit PCB Layout Diagrams—Internal 2

MAX30009 EV Kit PCB Layout Diagrams (continued)

MAX30009EVKIT# (continued)

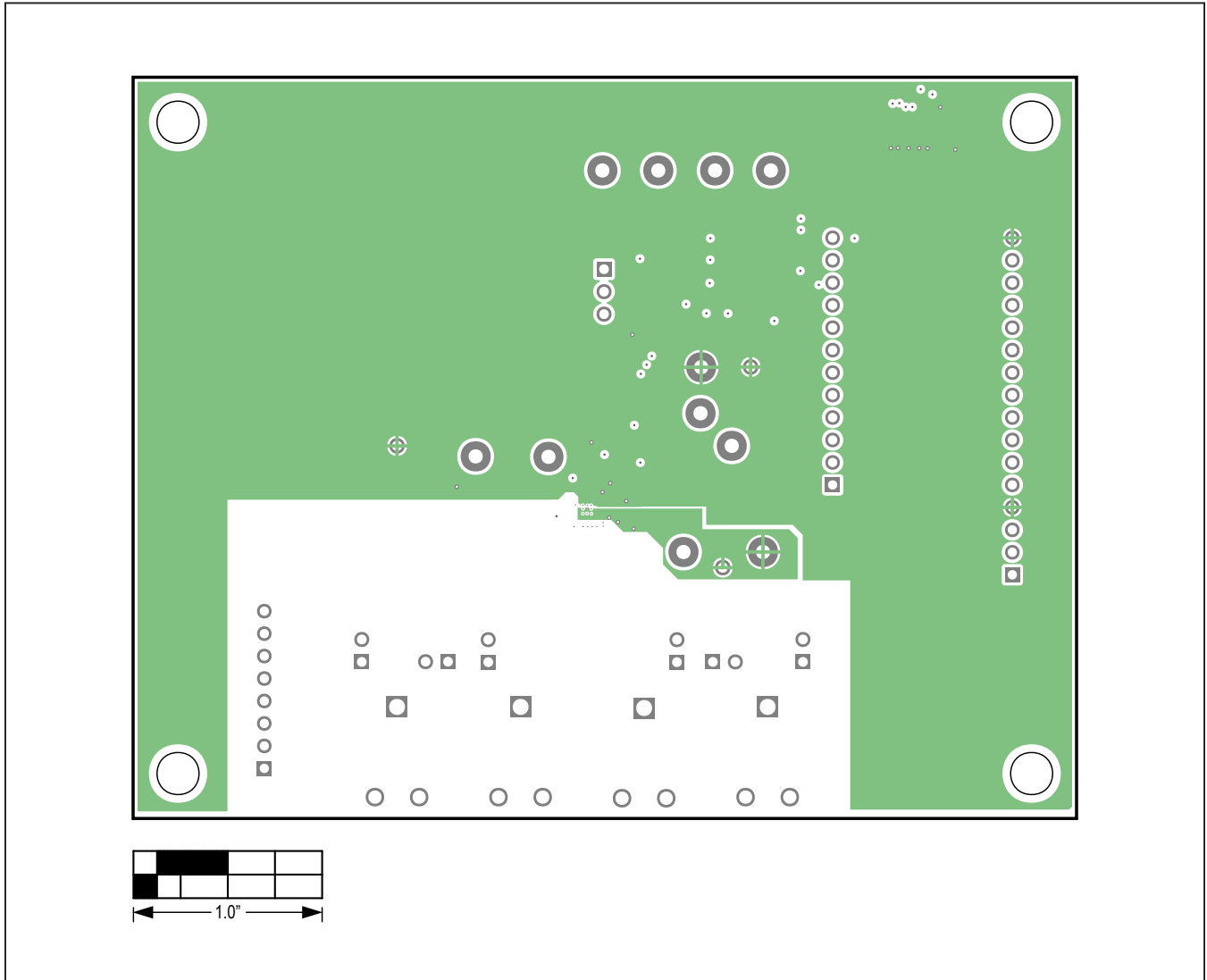

MAX30009EVKIT# EV Kit PCB Layout Diagrams—Internal 3

MAX30009 EV Kit PCB Layout Diagrams (continued)

MAX30009EVKIT# (continued)

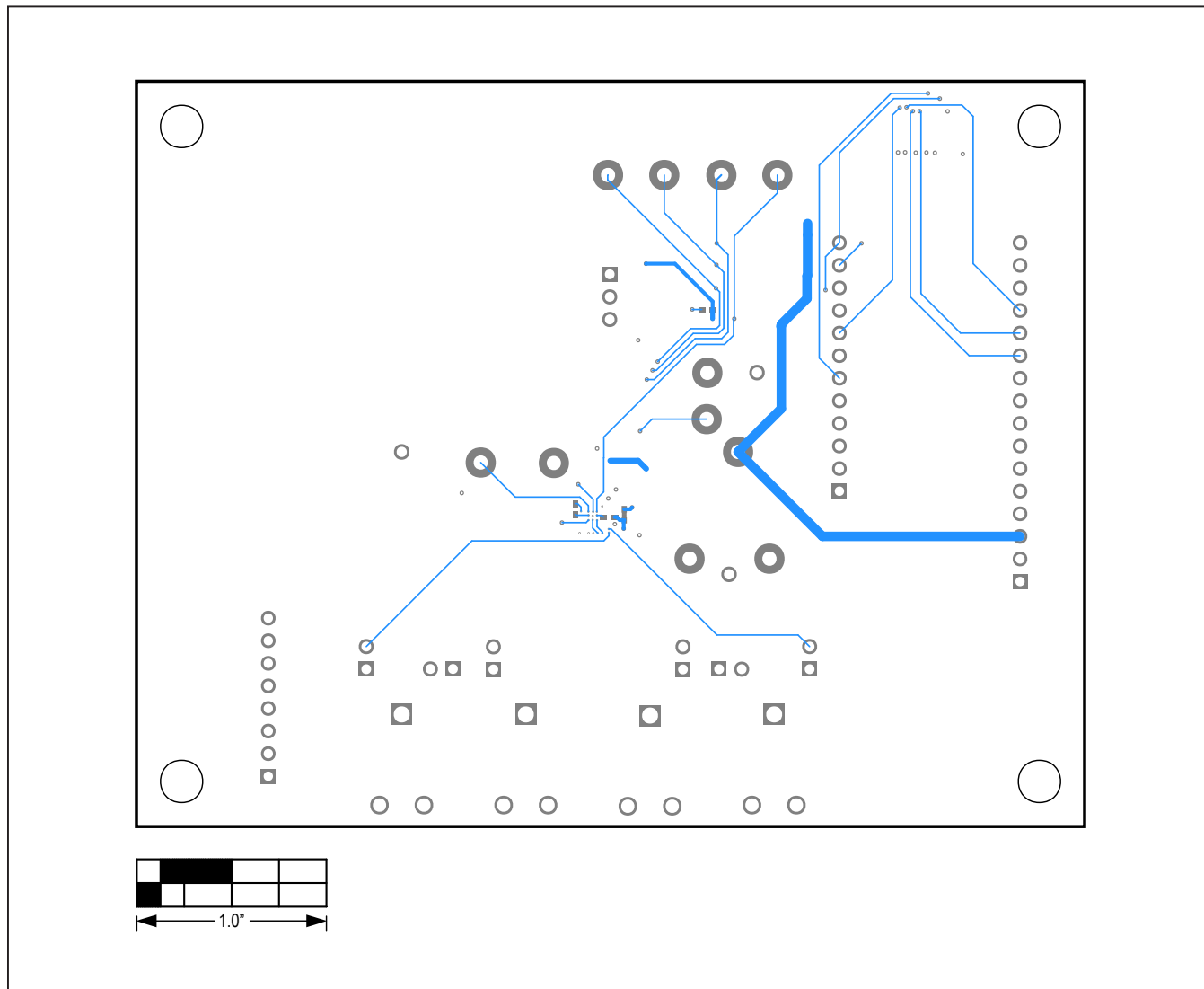

MAX30009EVKIT# EV Kit PCB Layout Diagrams—Bottom View

MAX30009 EV Kit PCB Layout Diagrams (continued)

MAX30009EVKIT# (continued)

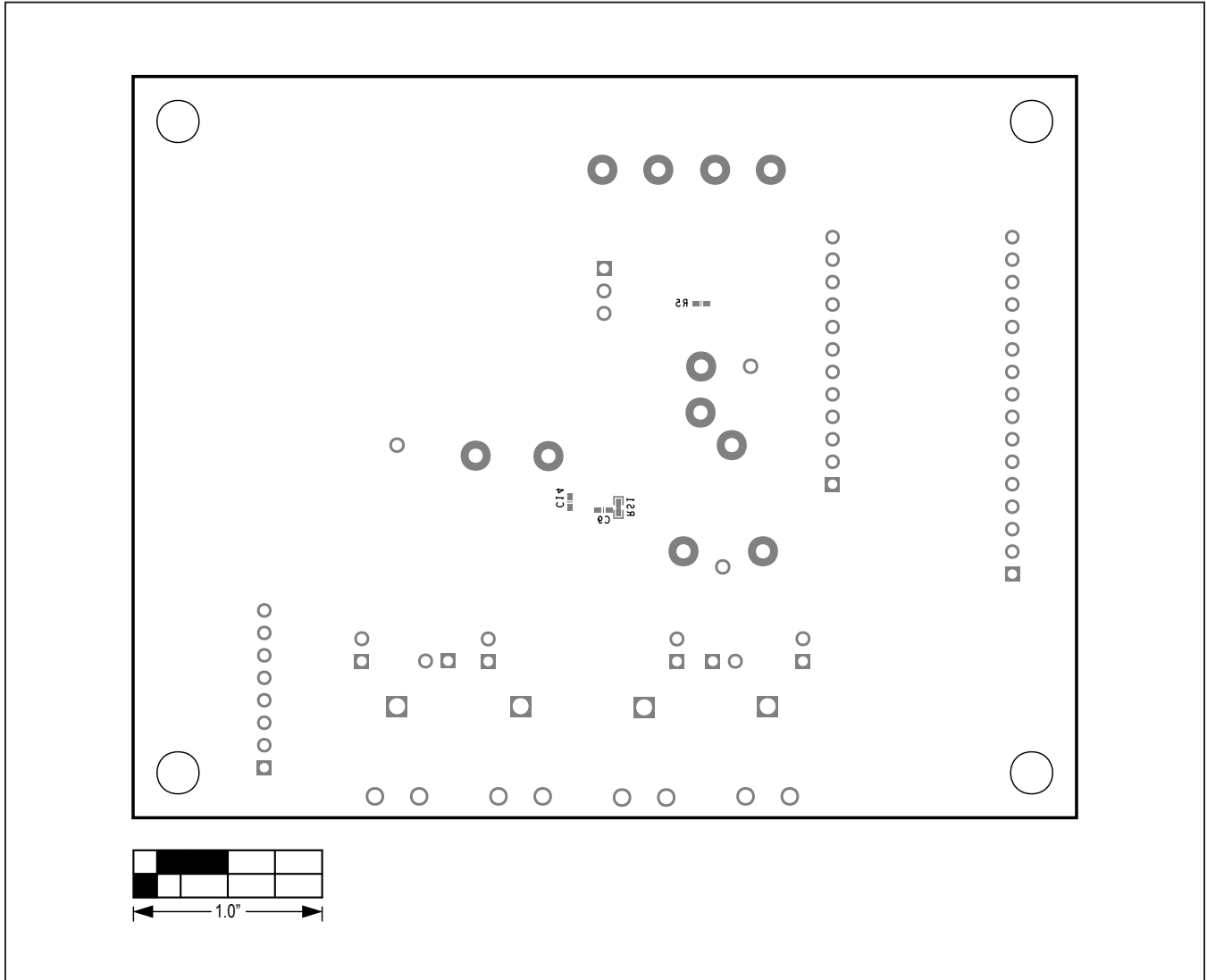

MAX30009EVKIT# EV Kit Component Placement Guide—Bottom Silkscreen

Revision History

REVISION NUMBER	REVISION DATE	DESCRIPTION	PAGES CHANGED
0	12/21	Initial release	—
1	07/22	Updated <i>General Description</i> , <i>EV Kit Contents</i> , <i>Quick Start</i> , <i>Detailed Description</i> of Software sections. Updated <i>Figure 3. Connect To Device window</i> and <i>Component List</i> table	1-5, 20
2	3/24	Added notes, updated <i>Quick Start</i> section, added MAXSENSORBLE_EVKIT_B <i>Bill of Materials</i> , <i>Schematics</i> , and <i>PCB Layout Diagrams</i>	1, 2, 21–36



Information furnished by Analog Devices is believed to be accurate and reliable. However, no responsibility is assumed by Analog Devices for its use, nor for any infringements of patents or other rights of third parties that may result from its use. Specifications subject to change without notice. No license is granted by implication or otherwise under any patent or patent rights of Analog Devices. Trademarks and registered trademarks are the property of their respective owners.