

5.08mm Pitch - Plug-in PCB Terminal Block Set

Pitch: 5.08mm
Direction:
Clamp: Screw cage
Poles: 2P
Mounting: Pluggable
N.W.: 0.00g

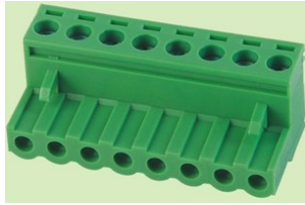

KF2EDGK 5.08

Pitch: 5.08mm
Direction: Vertical
Clamp:
Poles: 2P
Mounting: Pluggable
N.W.: 0.00g



KF2EDGV 5.08

Electrical

	Current	Voltage	Wire Range	Withstanding
IEC	15A	300V	28-12AWG	AC1500V
UL	10A			

Installation

Screw size	Torque	Strip Lgth	Max Solder
M2.5	0.50mm 4.4lb.in	8.00mm 0.31in	+250deg

Material

Screw: Galvanized Steel
Contact: Nickled brass
Clamp: Nickled brass, Galvanized Steel
Housing: PA66.UL94-0
Temp limit: -40deg+105deg
Color: Green

Electrical

	Current	Voltage	Withstanding
IEC	15A	300V	AC1500V
UL	10A		

Installation

Hole Size	Max Solder
1.40mm 0.06in	+250deg

Material

Screw:
Pin: Tin-plate brass
Clamp:
Housing: PA66.UL94-0
Temp limit: -40deg+105deg
Color: Green

No. Poles	N.W.	Box	Total
2P		1000pcs	.00g
3P		600pcs	.00g
4P		500pcs	.00g
5P		500pcs	.00g
6P		400pcs	.00g
7P		400pcs	.00g
8P		300pcs	.00g
9P		300pcs	.00g
10P		300pcs	.00g
11P		200pcs	.00g

No. Poles	N.W.	Box	Total
2P		1000pcs	.00g
3P		600pcs	.00g
4P		500pcs	.00g
5P		500pcs	.00g
6P		400pcs	.00g
7P		400pcs	.00g
8P		300pcs	.00g
9P		300pcs	.00g
10P		300pcs	.00g
11P		200pcs	.00g

Price: A /2P*1000 ROHS
 B \$29.50 /2P*1000
MOQ: 2P*1000,000

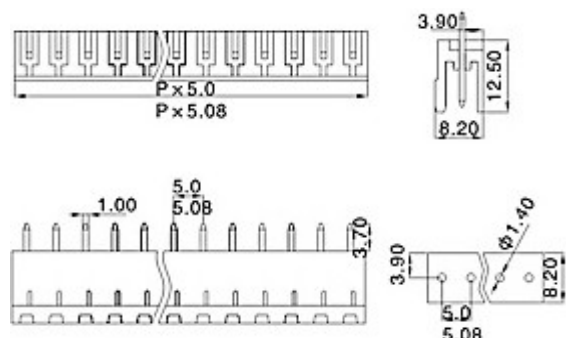
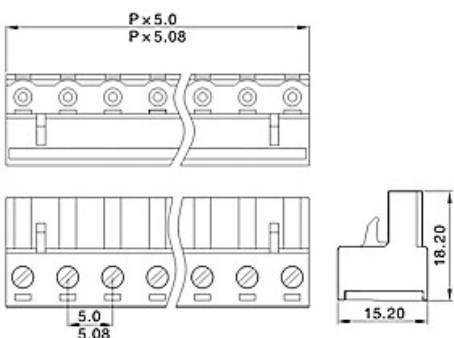

5.08mm Pitch - Plug-in PCB Terminal Block Female

Pitch: 5.08mm
Direction:
Clamp: Screw cage
Poles: 2P
Mounting: Pluggable
N.W.: 3.49g



KF2EDGKA 5.08

Pitch: 5.08mm
Direction:
Clamp: Screw cage
Poles: 2P
Mounting: Pluggable
N.W.: 3.49g



KF2EDGKB 5.08

Electrical

	Current	Voltage	Wire Range	Withstanding
IEC	15A	300V	28-12AWG	AC1500V
UL	10A			

Installation

	Screw size	Torque	Strip Lgth	Max Solder
	M2.5	0.50mm 4.4lb.in	8.00mm 0.31in	+250deg

Material

Screw:	Galvanized Steel
Contact:	Nickled brass
Clamp:	Nickled brass
Housing:	PA66.UL94-0
Temp limit:	-40deg-+105deg
Color:	Green

Electrical

	Current	Voltage	Wire Range	Withstanding
IEC	15A	300V	28-12AWG	AC1500V
UL	10A			

Installation

	Flang	Hole Size	Max Solder
	M2.5	1.40mm 0.06in	+250deg

Material

Screw:	Galvanized Steel
Contact:	Nickled brass
Clamp:	Nickled brass
Housing:	PA66.UL94-0
Temp limit:	-40deg-+105deg
Color:	Green

No. Poles	N.W.	Box	Total
2P	3.49g	1000pcs	3486.60g
3P	5.23g	600pcs	3137.94g
4P	6.97g	500pcs	3486.60g
5P	8.72g	500pcs	4358.25g
6P	10.46g	400pcs	4183.92g
7P	12.20g	400pcs	4881.24g
8P	13.95g	300pcs	4183.92g
9P	15.69g	300pcs	4706.91g
10P	17.43g	300pcs	5229.90g
11P	19.18g	200pcs	3835.26g

No. Poles	N.W.	Box	Total
2P	3.49g	1000pcs	3486.60g
3P	5.23g	600pcs	3137.94g
4P	6.97g	500pcs	3486.60g
5P	8.72g	500pcs	4358.25g
6P	10.46g	400pcs	4183.92g
7P	12.20g	400pcs	4881.24g
8P	13.95g	300pcs	4183.92g
9P	15.69g	300pcs	4706.91g
10P	17.43g	300pcs	5229.90g
11P	19.18g	200pcs	3835.26g

Price: A /2P*1000 ROHS
MOQ: 2P*1000,000

Price: A /2P*1000 ROHS
MOQ: 2P*1000,000

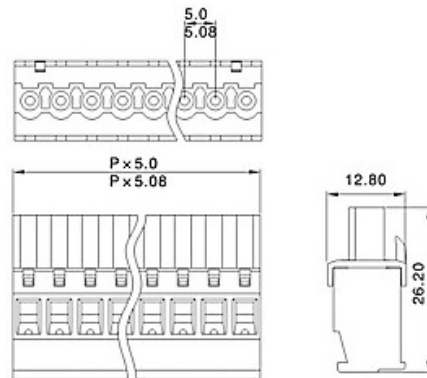
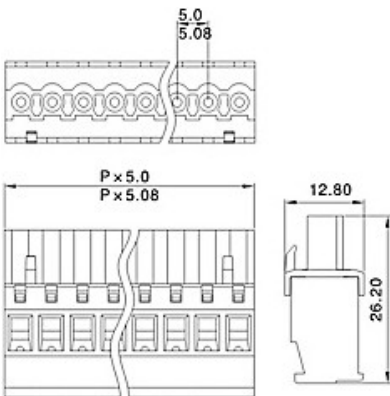

5.08mm Pitch - Plug-in PCB Terminal Block Set

Pitch: 5.08mm
Direction:
Clamp: Screw cage
Poles: 2P
Mounting: Pluggable
N.W.: 0.00g

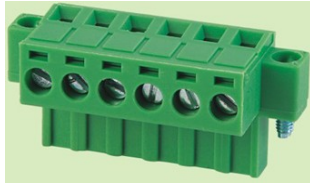

KF2EDGKM 5.08

Pitch: 5.08mm
Direction: Vertical
Clamp:
Poles: 2P
Mounting: Pluggable
N.W.: 0.00g

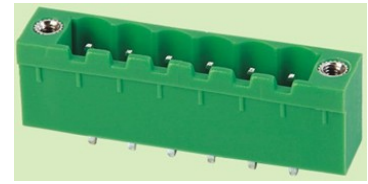

KF2EDGVM 5.08

Electrical

	Current	Voltage	Wire Range	Withstanding
IEC	15A	300V	28-12AWG	AC1500V
UL	10A			

Installation

	Screw size	Torque	Strip Lgth	Max Solder
	M2.5	0.50mm 4.4lb.in	8.00mm 0.31in	+250deg

Material

Screw: Galvanized Steel
Contact: Nickled brass
Clamp: Nickled brass, Galvanized Steel
Housing: PA66.UL94-0
Temp limit: -40deg+105deg
Color: Green

Electrical

	Current	Voltage	Withstanding
IEC	15A	300V	AC1500V
UL	10A		

Installation

	Flang	Hole Size	Max Solder
	M2.5	1.40mm 0.06in	+250deg

Material

Flang: Nickled brass
Pin: Tin-plate brass
Clamp:
Housing: PA66.UL94-0
Temp limit: -40deg+105deg
Color: Green

No. Poles	N.W.	Box	Total
2P		1000pcs	.00g
3P		600pcs	.00g
4P		500pcs	.00g
5P		500pcs	.00g
6P		400pcs	.00g
7P		400pcs	.00g
8P		300pcs	.00g
9P		300pcs	.00g
10P		300pcs	.00g
11P		200pcs	.00g

No. Poles	N.W.	Box	Total
2P		1000pcs	.00g
3P		600pcs	.00g
4P		500pcs	.00g
5P		500pcs	.00g
6P		400pcs	.00g
7P		400pcs	.00g
8P		300pcs	.00g
9P		300pcs	.00g
10P		300pcs	.00g
11P		200pcs	.00g

Price: A \$94.87 /2P*1000 ROHS
MOQ: 2P*1000,000

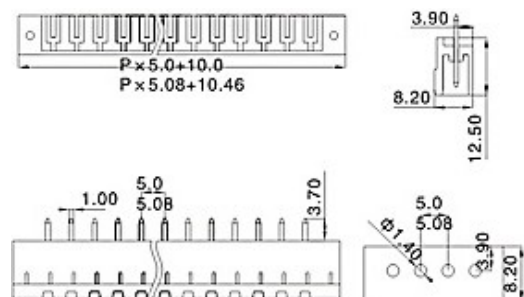
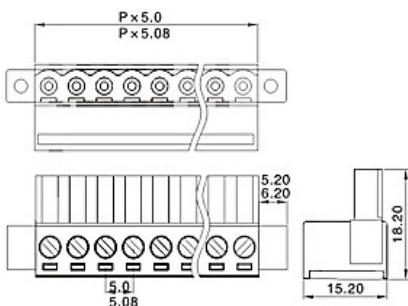

5.08mm Pitch - Pluggable Terminal Block Male Dual-Pin

Pitch: 5.08mm
Direction: Parallel
Clamp:
Poles: 2P
Mounting: Pluggable
N.W.: 0.00g



KF2EDGRT 5.08

Pitch: 5.08mm
Direction: Parallel
Clamp:
Poles: 2P
Mounting: Pluggable
N.W.: 0.00g

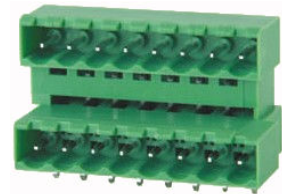

KF2EDGRTC 5.08

Electrical

	Current	Voltage	Withstanding
IEC	15A	300V	AC1500V
UL	10A		

Installation

	Hole Size	Max Solder
	1.60mm	+250deg
	0.06in	

Material

Screw:
Pin : Tin-plate brass
Clamp:
Housing: PA66.UL94-0
Temp limit: -40deg-+105deg
Color: Green

Electrical

	Current	Voltage	Withstanding
IEC	15A	300V	AC1500V
UL	10A		

Installation

	Hole Size	Max Solder
	1.60mm	+250deg
	0.06in	

Material

Screw:
Pin : Tin-plate brass
Clamp:
Housing: PA66.UL94-0
Temp limit: -40deg-+105deg
Color: Green

No. Poles	N.W.	Box	Total
2P		1000pcs	.00g
3P		600pcs	.00g
4P		500pcs	.00g
5P		500pcs	.00g
6P		400pcs	.00g
7P		400pcs	.00g
8P		300pcs	.00g
9P		300pcs	.00g
10P		300pcs	.00g
11P		200pcs	.00g

No. Poles	N.W.	Box	Total
2P		1000pcs	.00g
3P		600pcs	.00g
4P		500pcs	.00g
5P		500pcs	.00g
6P		400pcs	.00g
7P		400pcs	.00g
8P		300pcs	.00g
9P		300pcs	.00g
10P		300pcs	.00g
11P		200pcs	.00g

Price: A /2P*1000 ROHS
MOQ: 2P*1000,000

Price: A /2P*1000 ROHS
MOQ: 2P*1000,000

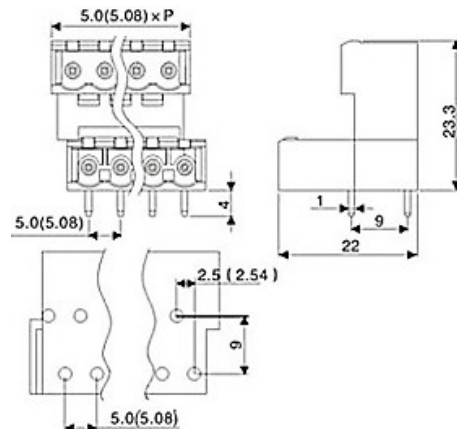
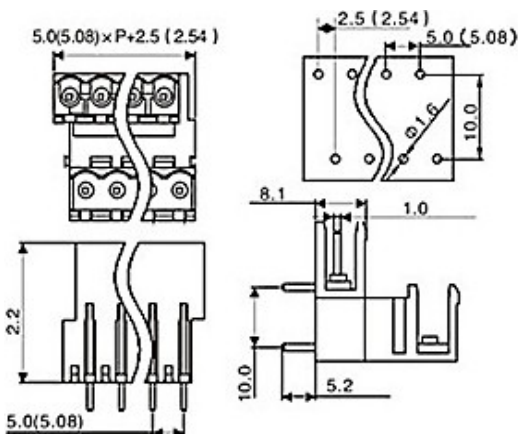

5.08mm Pitch - Pluggable Terminal Block Male Dual-Pin

Pitch: 5.08mm
Direction: Vertical
Clamp:
Poles: 2P
Mounting: Pluggable
N.W.: 0.00g



KF2EDGVT 5.08

Pitch: 5.08mm
Direction: Vertical
Clamp:
Poles: 2P
Mounting: Pluggable
N.W.: 0.00g

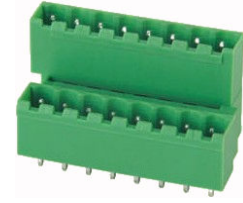

KF2EDGVTC 5.08

Electrical

	Current	Voltage	Withstanding
IEC	15A	300V	AC1500V
UL	10A		

Installation

	Hole Size	Max Solder
	1.60mm	+250deg
	0.06in	

Material

Screw:
Pin : Tin-plate brass
Clamp:
Housing: PA66.UL94-0
Temp limit: -40deg-+105deg
Color: Green

Electrical

	Current	Voltage	Withstanding
IEC	15A	300V	AC1500V
UL	10A		

Installation

	Hole Size	Max Solder
	1.60mm	+250deg
	0.06in	

Material

Screw:
Pin : Tin-plate brass
Clamp:
Housing: PA66.UL94-0
Temp limit: -40deg-+105deg
Color: Green

No. Poles	N.W.	Box	Total
2P		1000pcs	.00g
3P		600pcs	.00g
4P		500pcs	.00g
5P		500pcs	.00g
6P		400pcs	.00g
7P		400pcs	.00g
8P		300pcs	.00g
9P		300pcs	.00g
10P		300pcs	.00g
11P		200pcs	.00g

No. Poles	N.W.	Box	Total
2P		1000pcs	.00g
3P		600pcs	.00g
4P		500pcs	.00g
5P		500pcs	.00g
6P		400pcs	.00g
7P		400pcs	.00g
8P		300pcs	.00g
9P		300pcs	.00g
10P		300pcs	.00g
11P		200pcs	.00g

Price: A /2P*1000 ROHS
MOQ: 2P*1000,000

Price: A /2P*1000 ROHS
MOQ: 2P*1000,000

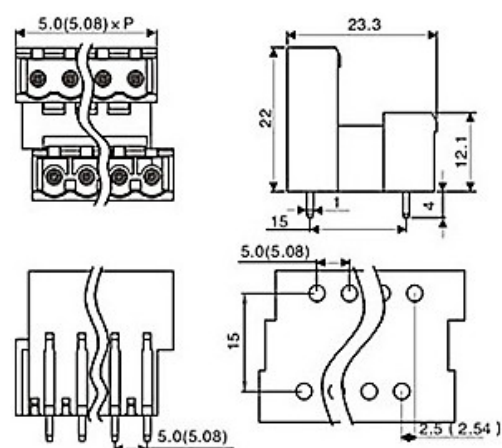
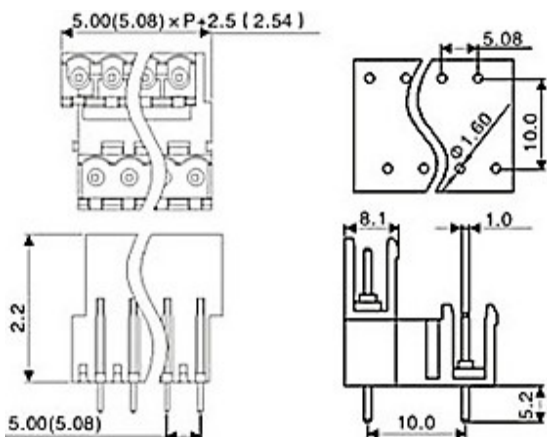

5.08mm Pitch - Pluggable Terminal Block Male Dual-Pin

Pitch: 5.08mm
Direction: Parallel
Clamp:
Poles: 2P
Mounting: Pluggable
N.W.: 0.00g

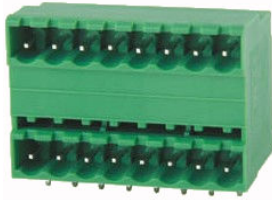

KF2EDGRH 5.08

Pitch: 5.08mm
Direction: Vertical
Clamp:
Poles: 2P
Mounting: Pluggable
N.W.: 0.00g

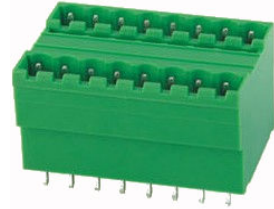

KF2EDGVH 5.08

Electrical

	Current	Voltage	Withstanding
IEC	15A	300V	AC1500V
UL	10A		

Electrical

	Current	Voltage	Withstanding
IEC	15A	300V	AC1500V
UL	10A		

Installation

	Hole Size	Max Solder
	1.60mm	+250deg
	0.06in	

Installation

	Hole Size	Max Solder
	1.60mm	+250deg
	0.06in	

Material

Screw:
Pin : Tin-plate brass
Clamp:
Housing: PA66.UL94-0
Temp limit: -40deg-+105deg
Color: Green

Material

Screw:
Pin : Tin-plate brass
Clamp:
Housing: PA66.UL94-0
Temp limit: -40deg-+105deg
Color: Green

No. Poles	N.W.	Box	Total
2P		1000pcs	.00g
3P		600pcs	.00g
4P		500pcs	.00g
5P		500pcs	.00g
6P		400pcs	.00g
7P		400pcs	.00g
8P		300pcs	.00g
9P		300pcs	.00g
10P		300pcs	.00g
11P		200pcs	.00g

No. Poles	N.W.	Box	Total
2P		1000pcs	.00g
3P		600pcs	.00g
4P		500pcs	.00g
5P		500pcs	.00g
6P		400pcs	.00g
7P		400pcs	.00g
8P		300pcs	.00g
9P		300pcs	.00g
10P		300pcs	.00g
11P		200pcs	.00g

Price: A /2P*1000 ROHS
MOQ: 2P*1000,000

Price: A /2P*1000 ROHS
MOQ: 2P*1000,000

