

TLP3617

Triac Drivers

Programmable Controllers

AC-Output Modules

Solid-State Relays

The TOSHIBA TLP3617 consists of a photo-triac optically coupled to a gallium arsenide infrared-emitting diode in an 8-lead plastic DIP package.

- Peak off-state voltage: 600 V (min.)
- Trigger LED current: 10 mA (max.)
- On-state current: 1.2 A_{rms} (max.)
- Isolation voltage: 2500 V_{rms} (min.)
- Zero-crossing function
- UL recognized: UL1577, File No. E67349

Unit: mm

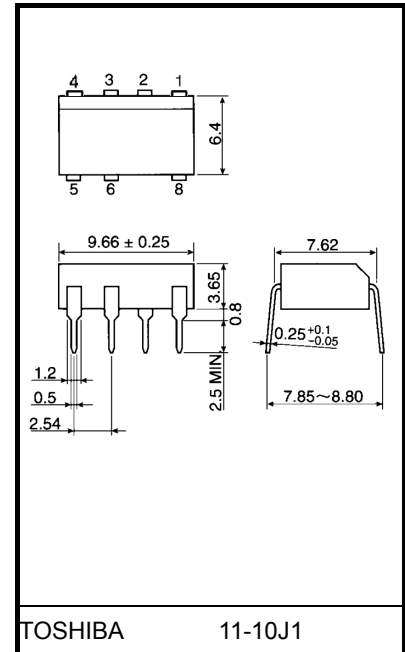

TOSHIBA 11-10J1

Weight: 0.59 g

Pin Configuration (top view)

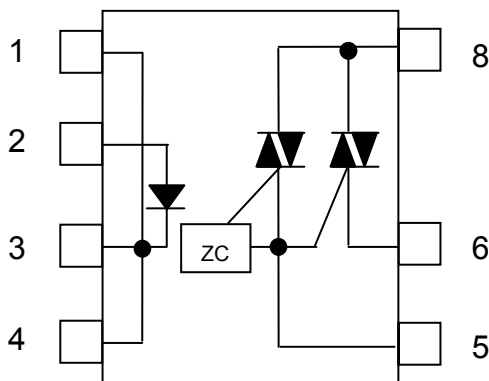

- 1: Cathode
- 2: Anode
- 3: Cathode
- 4: Cathode
- 5: Triac gate
- 6: Triac T1
- 8: Triac T2

Maximum Ratings (Ta = 25°C)

Characteristic		Symbol	Rating	Unit
LED	Forward current	I_F	50	mA
	Forward current derating (Ta ≥ 53°C)	$\Delta I_F / ^\circ\text{C}$	-0.7	mA / °C
	Peak forward current (100-μs pulse, 100 pps)	I_{FP}	1	A
	Reverse voltage	V_R	5	V
	Junction temperature	T_j	125	°C
Detector	Off-state output terminal voltage	V_{DRM}	600	V
	On-state RMS current	Ta = 25°C	1.2	A
		Ta = 40°C	1.0	
	On-state current derating (Ta ≥ 40°C)	$\Delta I_T / ^\circ\text{C}$	-13	mA / °C
	Peak current from snubber circuit (100-μs pulse, 120 pps)	I_{SP}	2	A
	Peak nonrepetitive surge current (50 Hz, peak)	I_{TSM}	5	A
	Junction temperature	T_j	115	°C
Storage temperature range	T_{stg}	-40~125	°C	
Operating temperature range	T_{opr}	-20~80	°C	
Lead soldering temperature (10 s)	T_{sol}	260	°C	
Isolation voltage (AC, 1 min., R.H. ≤ 60%) (Note)	BV_S	2500	V_{rms}	

Note: Device considered a two-terminal device: Pins 1, 2, 3 and 4 are shorted together, and pins 5, 6 and 8 are shorted together.

Recommended Operating Conditions

Characteristic	Symbol	Min	Typ.	Max	Unit
Supply voltage	V_{AC}	—	—	240	V_{ac}
Forward current	I_F	15	20	25	mA
Peak current from snubber circuit	I_{SP}	—	—	1	A
Operating temperature	T_{opr}	-20	—	80	°C

Individual Electrical Characteristics (Ta = 25°C)

Characteristic		Symbol	Test Condition	Min	Typ.	Max	Unit
LED	Forward voltage	V_F	$I_F = 10 \text{ mA}$	1.0	1.15	1.3	V
	Reverse current	I_R	$V_R = 5 \text{ V}$	—	—	10	μA
	Capacitance	C_T	$V = 0, f = 1 \text{ MHz}$	—	30	—	pF
Detector	Peak off-state current	I_{DRM}	$V_{DRM} = 600 \text{ V}, T_a = 110^\circ\text{C}$	—	—	100	μA
	Peak on-state voltage	V_{TM}	$I_{TM} = 1.2 \text{ A}$	—	—	3.0	V
	Critical rate of rise of off-state voltage	dv / dt	$V_{in} = 240 \text{ V}_{rms}$ (Fig. 1)	—	500	—	$\text{V} / \mu\text{s}$
	Critical rate of rise of commutating voltage	$dv / dt (c)$	$V_{in} = 240 \text{ V}_{rms}, I_T = 0.5 \text{ A}_{rms}$ (Fig. 1)	—	5	—	$\text{V} / \mu\text{s}$

Coupled Electrical Characteristics (Ta = 25°C)

Characteristic	Symbol	Test Condition	Min	Typ.	Max	Unit
Trigger LED current	I_{FT}	$V_T = 3 \text{ V}$	—	—	10	mA
Inhibit voltage	V_{IH}	$I_F = \text{Rated } I_{FT}$	—	—	20	V
Leakage in inhibited state	I_{IH}	$I_F = \text{Rated } I_{FT}$ $V_T = \text{Rated } V_{DRM}$	—	200	—	μA

Isolation Characteristics (Ta = 25°C)

Characteristic	Symbol	Test Condition	Min	Typ.	Max	Unit
Capacitance (input to output)	C_S	$V_S = 0, f = 1 \text{ MHz}$	—	1.5	—	pF
Isolation resistance	R_S	$V_S = 500 \text{ V}, \text{R.H.} \leq 60\%$	5×10^{10}	10^{14}	—	Ω
Isolation voltage	BV_S	AC, 1 minute	2500	—	—	V_{rms}
		AC, 1 second, in oil	—	5000	—	
		DC, 1 minute, in oil	—	5000	—	V_{dc}

Fig. 1: dv / dt test circuit

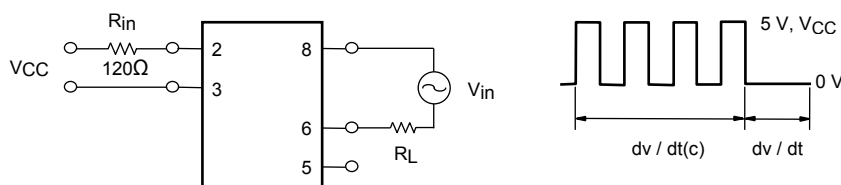

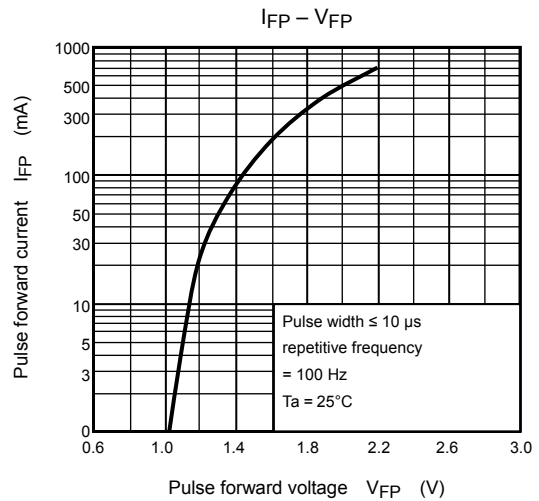
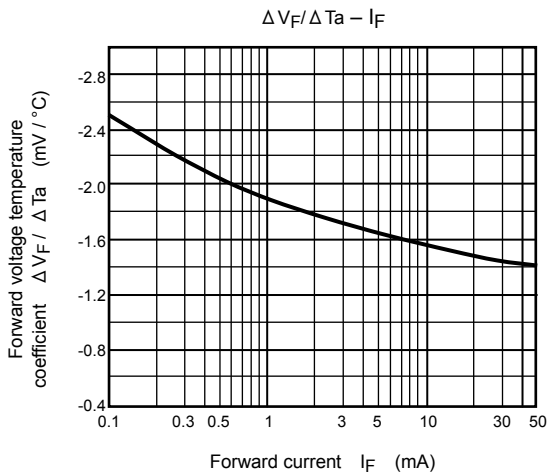
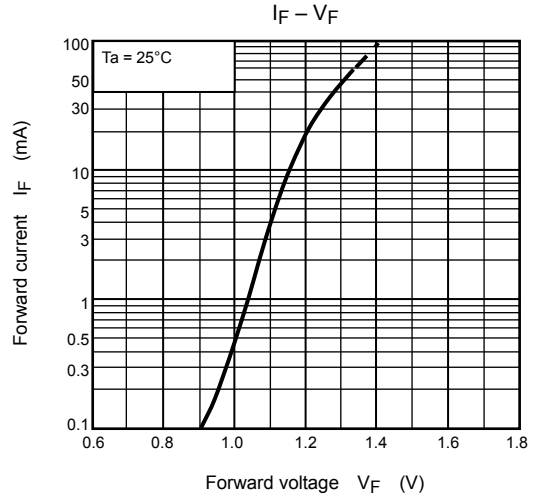
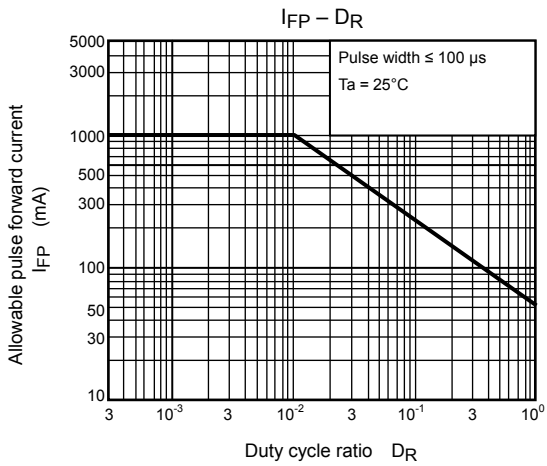
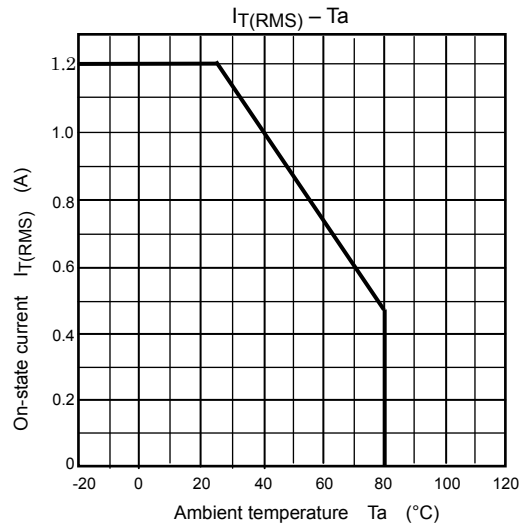
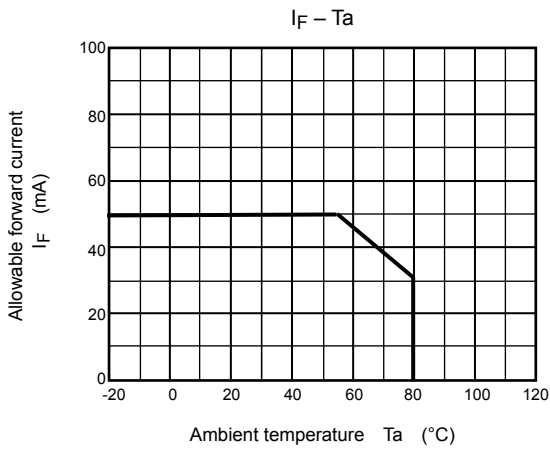

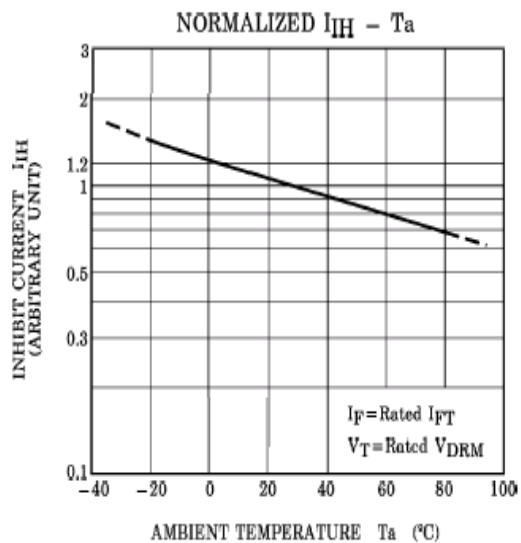
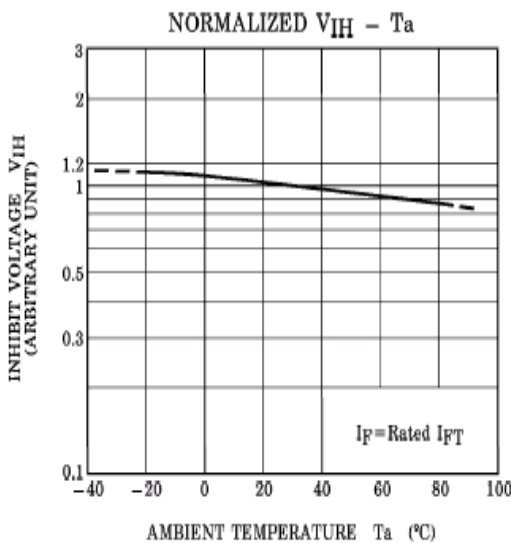
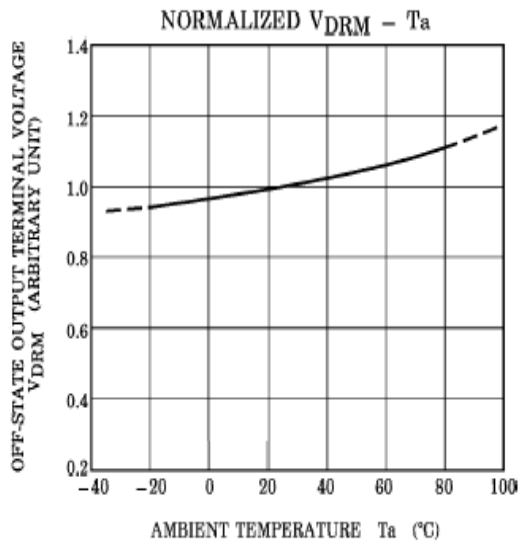
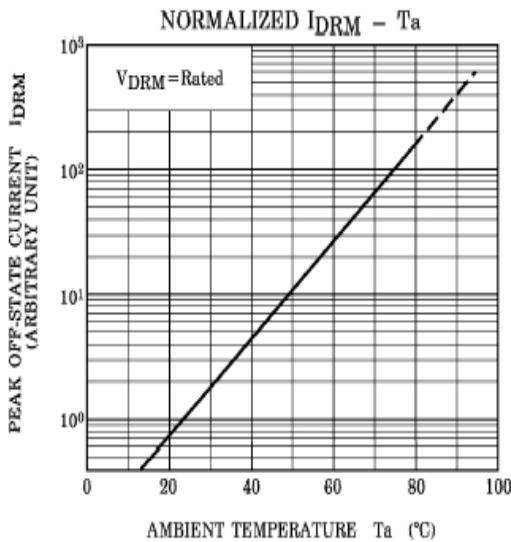
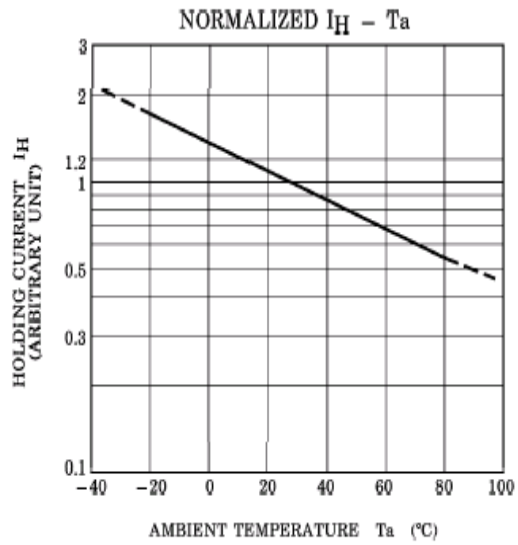
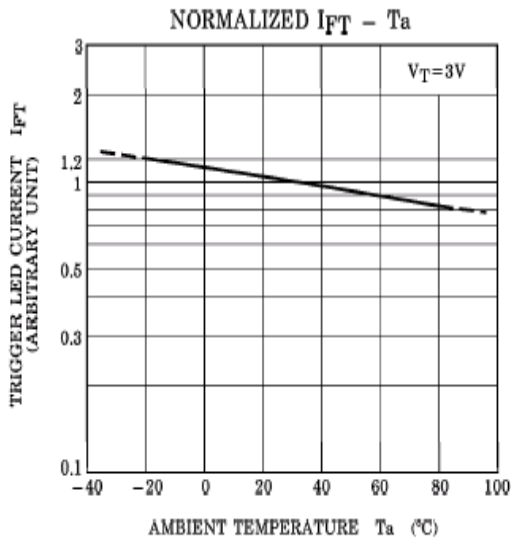

RESTRICTIONS ON PRODUCT USE

20070701-EN

- The information contained herein is subject to change without notice.
- TOSHIBA is continually working to improve the quality and reliability of its products. Nevertheless, semiconductor devices in general can malfunction or fail due to their inherent electrical sensitivity and vulnerability to physical stress. It is the responsibility of the buyer, when utilizing TOSHIBA products, to comply with the standards of safety in making a safe design for the entire system, and to avoid situations in which a malfunction or failure of such TOSHIBA products could cause loss of human life, bodily injury or damage to property.
In developing your designs, please ensure that TOSHIBA products are used within specified operating ranges as set forth in the most recent TOSHIBA products specifications. Also, please keep in mind the precautions and conditions set forth in the "Handling Guide for Semiconductor Devices," or "TOSHIBA Semiconductor Reliability Handbook" etc.
- The TOSHIBA products listed in this document are intended for usage in general electronics applications (computer, personal equipment, office equipment, measuring equipment, industrial robotics, domestic appliances, etc.). These TOSHIBA products are neither intended nor warranted for usage in equipment that requires extraordinarily high quality and/or reliability or a malfunction or failure of which may cause loss of human life or bodily injury ("Unintended Usage"). Unintended Usage include atomic energy control instruments, airplane or spaceship instruments, transportation instruments, traffic signal instruments, combustion control instruments, medical instruments, all types of safety devices, etc.. Unintended Usage of TOSHIBA products listed in this document shall be made at the customer's own risk.
- The products described in this document shall not be used or embedded to any downstream products of which manufacture, use and/or sale are prohibited under any applicable laws and regulations.
- The information contained herein is presented only as a guide for the applications of our products. No responsibility is assumed by TOSHIBA for any infringements of patents or other rights of the third parties which may result from its use. No license is granted by implication or otherwise under any patents or other rights of TOSHIBA or the third parties.
- GaAs(Gallium Arsenide) is used in this product. The dust or vapor is harmful to the human body. Do not break, cut, crush or dissolve chemically.
- Please contact your sales representative for product-by-product details in this document regarding RoHS compatibility. Please use these products in this document in compliance with all applicable laws and regulations that regulate the inclusion or use of controlled substances. Toshiba assumes no liability for damage or losses occurring as a result of noncompliance with applicable laws and regulations.