

IR RECEIVER (0805)

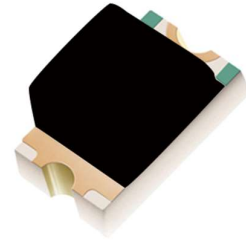

技术数据表 Technical Data

0805 光敏接收管 贴片式发光二极管



特点 (Characteristics) :

* 外观尺寸 (L/W/H) :2.0*1.25*0.8 mm

Outline Dimensions(L / w / h): 2.0 x 1.25 x 0.8 mm

* 颜色及胶体: 0805 光敏接收管/黑色胶体

Color and colloid: 0805 photosensitive receiving tube / black colloid

* 环保工艺符合 ROHS 要求

Environmental protection products Complied With ROHS Directive

* 湿气敏感性等级 (MSL) :4-5 级

Moisture sensitivity level (MSL) : 4-5 levels

* EIA 规范标准包装

EIA standard packaging

* 适用于 SMT 贴片自动化生产

应用领域 (Product application) :

*智能产品家电虹膜识别

Intelligent product household appliance iris recognition;

*红外发光微型光障

Infrared luminescent micro light barrier

*软盘驱动器

floppy disk driver

*光电开关 Photoelectric switch

*烟雾探测器 Smoke Detector

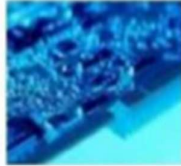

目录

Catalogue

电性参数

Electrical Characteristics..... 3

典型特性曲线

Typical Characteristic Curves.....6

可靠性实验

Reliability Test Items And Conditions.....7

外形尺寸

Outline Dimensions.....8

包装

Packaging.....9

焊接指导

Guideline for Soldering.....11

电性参数

Electrical Characteristics

极限参数 (Ta=25℃) Absolute Maximum Rating (ta=25 °C)

参数名称 Parameter	符号 Symbol	最大额定值 Maximum rating	单位 Unit
集电极-发射极电压 Collector Emitter Voltage	V _{CEO}	30	V
发射极-集电极电压 Emitter collector voltage	V _{ECO}	5	V
工作环境温度 Operating ambient temperature	Topr	-25°C~+85°C	
储存环境温度 Storage ambient temperature	Tstg	-40°C~+85°C	
焊接条件 Welding conditions	Tsol	回流焊 (reflow soldering) : 260°C, 6s 手动焊 (manual welding) : 300°C, 3s	

光电参数 (Ta=25°C) Optical-electrical parameter (ta=25 °C)

参数 Parameter	符号 Symbol	最小值 Min	代表值 Typ	最大值 Max	单位 Unit	测试条件 Test conditions
集电极-发射极击穿电压 Collector emitter breakdown voltage	BV_{CEO}	85	/	/	V	$I_{CEO}=100\mu A$ $E_e=0mW/cm^2$
发射极-集电极击穿压 Emitter collector breakdown voltage	BV_{ECO}	8.2	/	/	V	$I_{ECO}=10\mu A$ $E_e=0mW/m^2$
集电极-基极击穿电压 Collector base breakdown voltage	BV_{CBO}	85	/	/	V	$I_{CBO}=100\mu A$ $E_e=0mW/cm^2$
集电极暗电流 Collector dark current	I_{CEO}	/	/	30	nA	$V_{CE}=20V$ $E_e=0mW/cm^2$
集电极-发射极饱和电压 Collector-emitter saturation voltage	$V_{CE(sat)}$	/	/	0.3	V	$I_C=2mA$, $I_B=100\mu A$ $E_e=1mW/cm^2$
峰值敏感波长 Peak sensitive wavelength	λ_p	/	880	/	nm	/
电流放大因子 Current amplification factor	hFE	200	/	2300		$V_{CE}=5V$ $I_C=2mA$
下降时间 Descent time	T_f	/	15	/	μS	$V_{CE}=5V$, $I_C=1mA$ $R_L=1000\Omega$



光电流 1 Photocurrent 1	I_{PCE}	300	/	400	μA	$E_e=1mW/cm^2$, $\lambda_p=850nm$ $V_{CE}=5V$
光电流 2 Photocurrent 2	I_{PCE}	500	/	600	μA	$E_e=1mW/cm^2$, $\lambda_p=940nm$ $V_{CE}=5V$
光谱带宽 Spectral bandwidth	$\lambda_{0.5}$	700	/	1100	nm	/
上升时间 Rise time	T_r	/	15	/	μS	$V_{CE}=5V, I_C=1mA$ $R_L=1000\Omega$

光电流分档:

Photo current grading:

代码 Code	最小值 Min	最大值 Max	单位 Unit
IC6-12	0.3	0.6	mA

典型特性曲线

Typical Characteristics Curves

图一：光谱敏感度曲线

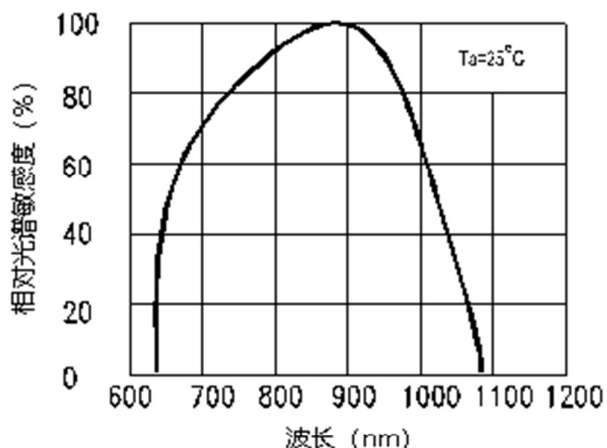

图二：集电极暗电流VS环境温度曲线

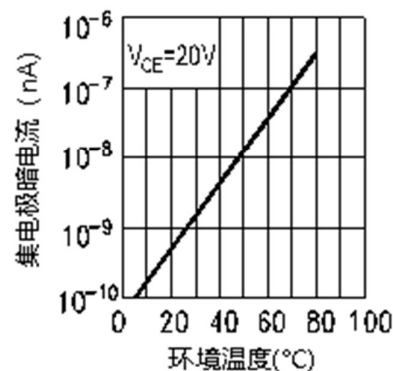

图三：耗散功率VS环境温度曲线

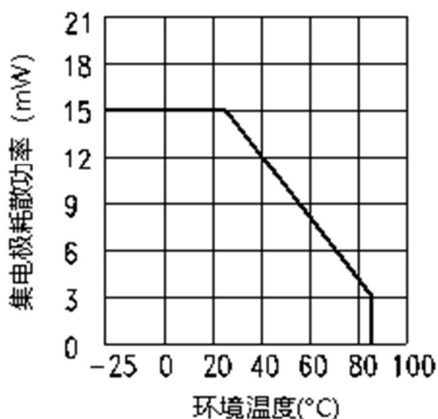

图四：相对集电极电流强度VS环境温度曲线

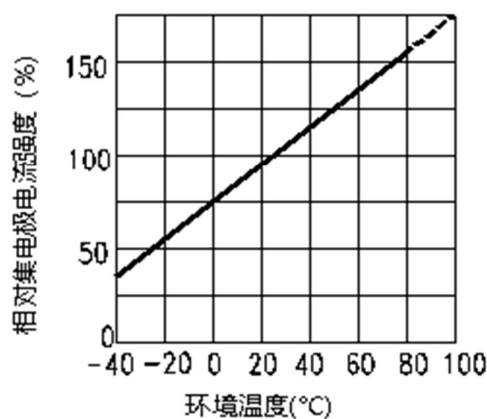

图五：集电极电流VS辐射照度

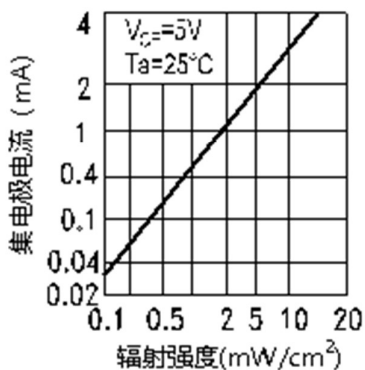

图六：光电流VS V_CEO曲线

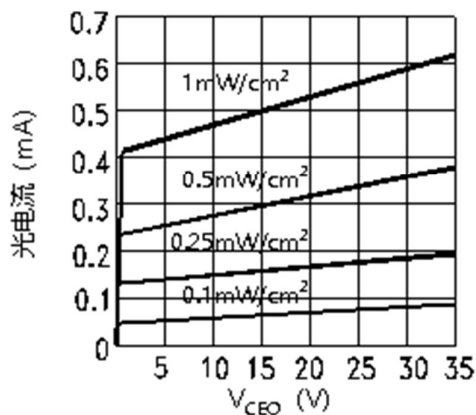

可靠性试验

Reliability Test Items And Conditions

类别	测试项目 Test	测试环境	测试时间	参考标准
耐久性测试 Endurance test	工作寿命 Working life	室温条件下以最大额定电流持续点亮; 以 20mA 测试 (Continuous lighting at the maximum rated current at room temperature; Test it at 20mA.)	1000 小时 1000 hours (-24 小时, +72 小时) (-24hours, +72hours)	MIL-STD-750D:1026 MIL-STD-883D:1005
	高温高湿储存 High temperature and high humidity storage	IR-Reflow In-Board, 2 Times 环境温度 Ta= 85±5℃, 相对湿度 RH= 90~95%	240 小时 240hours (±2 小时) (±2hours)	MIL-STD-202F:103B JIS C 7021:B-11
	高温储存 High-temperature storage	环境温度 Ta= 85±5℃	1000 小时 1000 hours (-24 小时 +72 小时) (-24hours+72hours)	MIL-STD-883D:1008 JIS C 7021:B-10
	低温储存 Low	环境温度 Ta= -40±5℃		JIS C 7021:B-12
环境测试 Environmental testing	冷热循环 Cold and hot cycle	105℃ ~ 25℃ ~ -55℃ ~ 25℃ 30mins 5mins 30mins 5mins	50 次循环 50 Circles	MIL-STD-202F:107D MIL-STD-750D:1051
	冷热冲击 Hot and cold impact	IR-Reflow In-Board, 2 Times; 100± 5℃ ~ -40℃ ± 5℃; 20mins ; 20mins	50 次循环 50 Circles	MIL-STD-202F:107D MIL-STD-750D:1051
	抗锡试验 Anti-tin test	焊锡温度 T.sol= 260 ± 5℃	10 ± 1secs 2 次 2times	MIL-STD-202F:210A MIL-STD-750D:2031
	红外回流焊 无铅制程 Infrared reflowwelding There is lead process	升温速度 heat up speed (183℃到最高值) : 最大 3℃/秒; 维持温度 keep temperature 在 125(±25)℃: 不超过 120 秒; 维持温度 keep temperature 在 183℃以上: 60-150 秒 最高温度限制范围 maximum temperature: 235℃+5/-0℃; 维持在 235℃+5/-0℃ 时间: 10-15 秒; 降温速度 cooling rate: 最大 6℃/秒		MIL-STD-750D:2031.2 J-STD-020C
	红外回流焊 无铅制程 Infrared reflow welding Lead-free process	升温速度 heat up speed (217℃到最高值) : 最大 3℃/秒; 维持温度 keep temperature 在 175(±25)℃: 不超过 180 秒; 维持温度 keep temperature 在 217℃以上: 60-120 秒 最高温度限制范围 maximum temperature: 255℃+0/-5℃; 维持在 255℃+0/-5℃ 时间: 5-10 秒; 降温速度 cooling rate: 最大 6℃/秒		MIL-STD-750D:2031.2 J-STD-020C
可焊性试验 Weldability test	焊锡温度 Soldering temperature T.sol= 235 ± 5℃; 浸入速度 Immersion speed: 25±2.5 mm/秒; 上锡率 ≥95% 焊盘面积; Tin loading rate ≥ 95% pad area Immersion time: 2 ± 0.5 seconds	浸入时间 Immersion time: 2±0.5 秒	MIL-STD-202F:208D MIL-STD-750D:2026 MIL-STD-883D:2003	

备注： 1. 单位：毫米（mm）

Remarks: 1. Unit: mm

2.公差： 如无特别标注则为 $\pm 0.10\text{mm}$

2.Tolerance: $\pm 0.10\text{mm}$ unless otherwise specified

包装（1）

Packaging (1)

载带与圆盘尺寸 Belt and disk dimensions

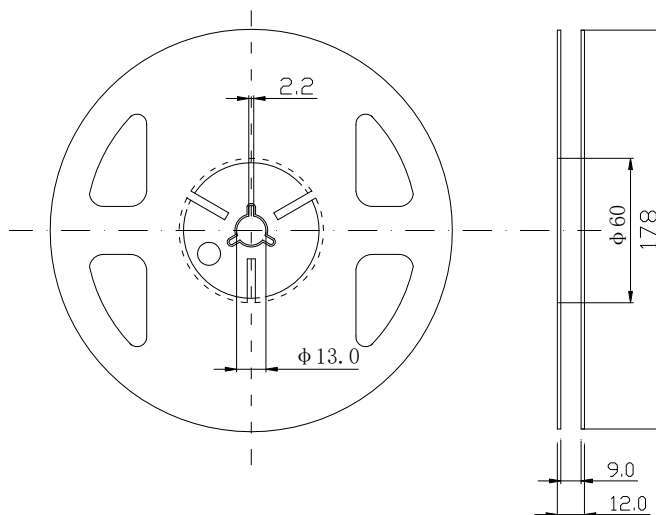
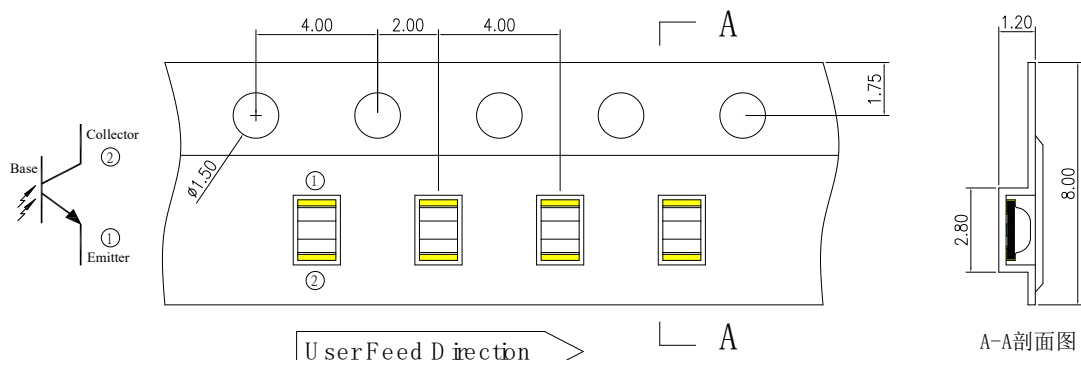

注:

1. 尺寸单位为毫米(mm).
1. Size unit is mm (mm).
2. 尺寸公差是 $\pm 0.1\text{mm}$.
2. The dimensional tolerance is $\pm 0.1\text{mm}$.

◇ 圆盘及载带卷出方向及空穴规格 Disk and carrier belt direction of roll and hole dimensions

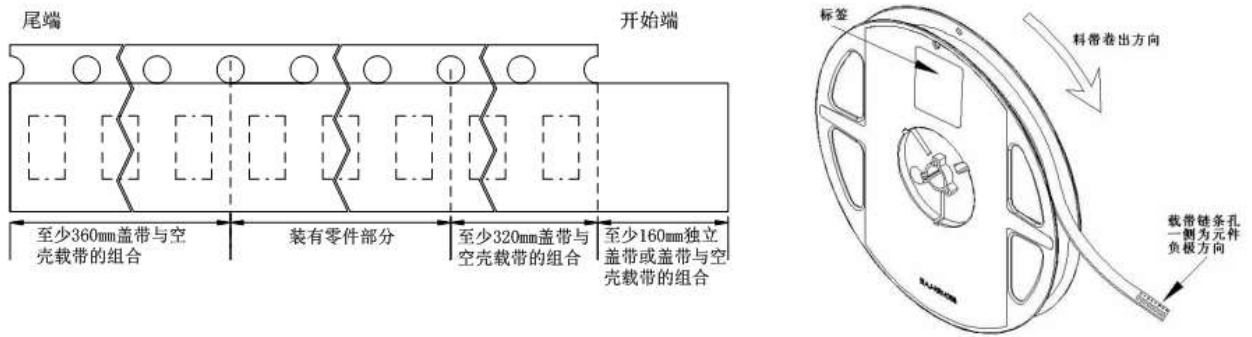

包装 (2)

Packaging (2)

焊接指导 (1)

Guideline for Soldering (1)

1. 使用烙铁人手焊接

Hand Soldering

只建议在修理和重工的情况下使用手工焊接；推荐使用功率低于 30W 的烙铁，焊接时烙铁的温度必须保持在 300℃ 以下，且每个电极只能进行一次焊接，每次焊接的持续时间不得超过 3 秒。

人手焊接过程中的不慎操作易引起 LED 产品的损坏，应当小心谨慎。

Manual welding is recommended only for repair and heavy industry situations. A soldering iron of less than 30W is recommended to be used in Hand Soldering. Please keep the temperature of the soldering iron under 300℃ while soldering. Each terminal of the LED is to go for less than 3 second and for one time only.

Be careful because the damage of the product is often started at the time of the hand soldering.

2. 回流焊接： 推荐使用以下无铅回流焊接温度图进行。

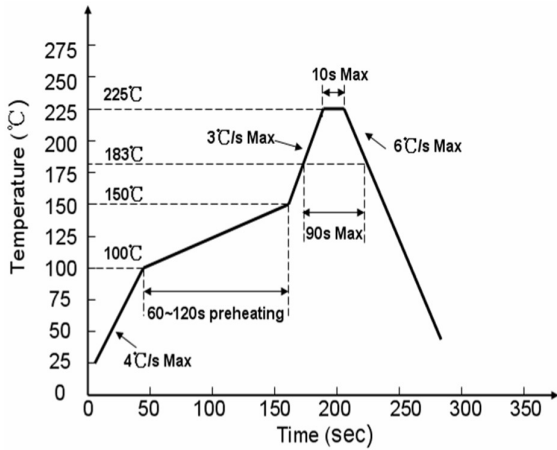

有铅制程 Lead process

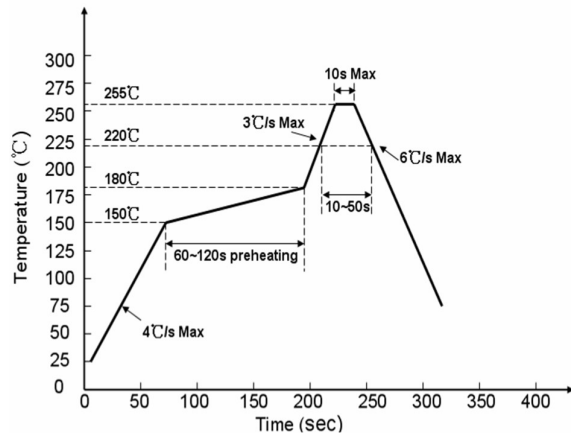

无铅制程 lead free

回流焊接最多只能进行两次。

Reflow soldering should not be done more than two times.

在回流焊接升温过程中，请不要对 LED 施加任何压力。

Stress on the LEDs should be avoided during heating in soldering process.

在焊接完成后，待产品温度下降到室温之后，再进行其他处理。

After soldering, do not deal with the product before its temperature drop down to room temperature.

焊接指导 (2)

Guideline for Soldering (2)

3. 清洗:

Cleaning

在焊接后推荐使用酒精进行清洗，在温度不高于 30°C 的条件下持续 3 分钟，不高于 50°C 的条件下持续 30 秒。

使用其他类似溶剂清洗前，请先确认使用的溶剂不会对 LED 的封装和环氧树脂部分造成损伤。超声波清洗也是有效的方法，一般最大功率不应超过 300W，否则可能对 LED 造成损伤。请根据具体的情况预先测试清洗条件是否会对 LED 造成损伤。

It is recommended that alcohol be used as a solvent for cleaning after soldering. Cleaning is to go under 30°C for 3 minutes or 50°C for 30 seconds. When using other solvents, it should be confirmed beforehand whether the solvents will dissolve the package and the resin or not.

Ultrasonic cleaning is also an effective way for cleaning. But the influence of Ultrasonic cleaning on LED depends on factors such as ultrasonic power. Generally, the ultrasonic power should not be higher than 300W. Before cleaning, a pretest should be done to confirm whether any damage to LEDs will occur.

* **注意:** 此一般指导原则并不适用于所有 PCB 设计和焊接设备的配置。具体工艺受到诸多因素的影响，请根据特定的 PCB 设计和焊接设备来确定焊接方案。

* **Note:** This general guideline may not apply to all PCB designs and configurations of all soldering equipment. The technics in practise is influenced by many factors, it should be specialized base on the PCB designs and configurations of the soldering equipment..

使用注意事项（1）

Precautions (1)

1. 贮存:

Storage

- 本产品使用密封防潮防静电袋包装，并附有干燥剂，未开封的产品有一年的保存时间。

Moisture proof and anti-electrostatic package with moisture absorbent material is used, to keep moisture to a minimum.

- 开封前，产品须存放在温度不高于 30℃，湿度不高于 60%RH 的环境中。

Before opening the package, the product should be kept at 30℃ or less and humidity less than 60% RH, and be used within a year.

- 开封后，产品须存放在温度不高于 30℃，湿度不高于 10%RH 的环境中，且应该在 168 小时（7 天）内使用完。建议工作环境为温度不高于 30℃，湿度不高于 60%RH。

After opening the package, the product should be stored at 30℃ or less and humidity less than 10%RH, and be soldered within 168 hours (7 days). It is recommended that the product be operated at the workshop condition of 30℃ or less and humidity less than 60%RH.

- 对于尚未焊接的 LED，如果吸湿剂或包装失效，或者产品没有符合以上有效存储条件，烘焙可以起到一定的性能恢复效果。烘焙条件：60±5℃，持续24 小时。

If the moisture absorbent material has fade away or the LEDs have exceeded the storage time, baking treatment should be performed based on the following condition: (60±5)℃ for 24 hours.

2. 静电:

Static Electricity

静电和电涌会导致产品特性发生改变，例如正向电压降低等，如果情况严重甚至会损毁产品。所以在使用时必须采取有效的防静电措施。所有相关的设备和机器都应该正确接地，同时必须采取其他防止静电和电涌的措施。使用防静电手环，防静电垫子，防静电工作服、工作鞋、手套，防静电容器，都是有效的防止静电和电涌的措施。

Static electricity or surge voltage damages the LEDs. Damaged LEDs will show some unusual characteristic such as the forward voltage becomes lower, or the LEDs do not light at the low current. even not light.

All devices, equipment and machinery must be properly grounded. At the same time, it is recommended that wrist bands or anti-electrostatic gloves, anti-electrostatic containers be used when dealing with the LEDs.

使用注意事项 (2)

Precautions (2)

3. 设计建议:

Design Consideration

设计电路时, 通过 LED 的电流不能超过规定的最大值, 同时, 还需使用保护电阻, 否则, 微小的电压变化将会引起较大的电流变化, 可能导致产品损毁。

建议使用以下 (A) 电路, 该电路能够很好的调节通过每个 LED 的电流; 不推荐使用 (B) 电路, 该电路在持续的电压驱动下, LED 的正向电压 (V_F) 发生变化, 电流会随之而发生变化, 可能使某些 LED 承受高于规定的电流值。

In designing a circuit, the current through each LED must not exceed the absolute maximum rating specified for each LED. In the meanwhile, resistors for protection should be applied, otherwise slight voltage shift will cause big current change, burn out may happen.

It is recommended to use Circuit A which regulates the current flowing through each LED rather than Circuit B. When driving LEDs with a constant voltage in Circuit B, the current through the LEDs may vary due to the variation in Forward Voltage (V_F) of the LEDs. In the worst case, some LED may be subjected to stresses in excess of the Absolute Maximum Rating.

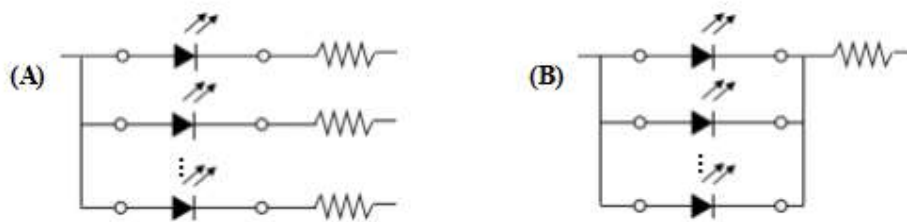

LED 的特性容易因为自身的发热和环境的温度的改变而发生改变。温度的升高会降低 LED 的发光效率、影响发光颜色等, 所以在设计时应充分考虑散热的问题。

Thermal Design is paramount importance because heat generation may result in the Characteristics decline, such as brightness decreased, Color changed and so on. Please consider the heat generation of the LEDs when making the system design.

使用注意事项 (3)

Precautions (3)

4. 其他事项:

Others

直接用手拿取产品不但会污染封装树脂表面,也可能由于静电等因素导致产品性能的改变。过度的压力也可能直接影响封装内部的管芯和金线,因此请勿对产品施加过度压力,特别当产品处于高温状态下,例如在回流焊接过程中。

When handling the product, touching the encapsulant with bare hands will not only contaminate its surface, but also affect on its optical characteristics. Excessive force to the encapsulant might result in catastrophic failure of the LEDs due to die breakage or wire deformation. For this reason, please do not put excessive stress on LEDs, especially when the LEDs are heated such as during Reflow Soldering.

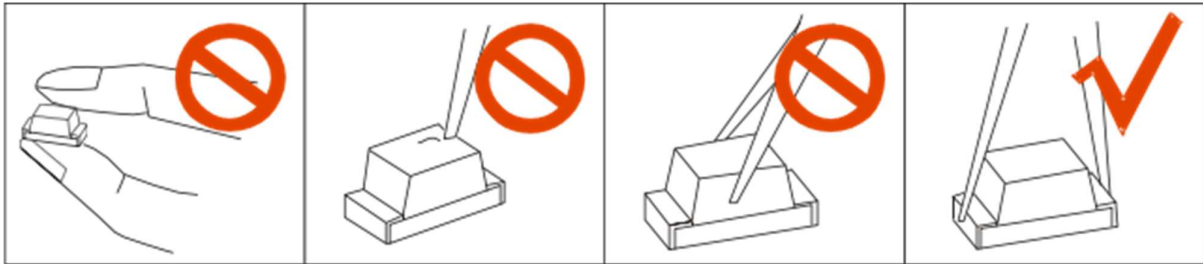

LED 的环氧树脂封装部分相当脆弱,请勿用坚硬、尖锐的物体刮、擦封装树脂部分。在用镊子夹取的时候也应当小心注意。

The epoxy resin of encapsulant is fragile, so please avoid scratch or friction over the epoxy resin surface. While handling the product with tweezers, do not hold by the epoxy resin, be careful.

5. 眼睛保护忠告:

Safety Advice For Human Eyes

LED 发光时,请勿直视发光光源,特别是对于一些光强较高的 LED,强光可能伤害你的眼睛。

Viewing direct to the light emitting center of the LEDs, especially those of great Luminous Intensity, will cause great hazard to human eyes. Please be careful.