

## PNP Silicon Transistors

**SMBT 5086**  
**SMBT 5087**

- For AF input stages and driver applications
- High current gain
- Low collector-emitter saturation voltage
- Low noise between 30 Hz and 15 kHz

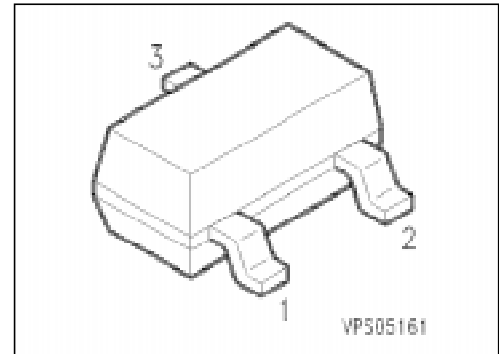

Type	Marking	Ordering Code (tape and reel)	Pin Configuration			Package <sup>1)</sup>
			1	2	3	
SMBT 5086	s2P	Q62702-M0002	B	E	C	SOT-23
SMBT 5087	s2Q	Q68000-A8319				

### Maximum Ratings

Parameter	Symbol	Values	Unit
Collector-emitter voltage	$V_{CE0}$	50	V
Collector-base voltage	$V_{CB0}$	50	
Emitter-base voltage	$V_{EB0}$	3	
Collector current	$I_C$	50	mA
Total power dissipation, $T_s = 71\text{ °C}$	$P_{tot}$	330	mW
Junction temperature	$T_j$	150	°C
Storage temperature range	$T_{stg}$	- 65 ... + 150	

### Thermal Resistance

Junction - ambient <sup>2)</sup>	$R_{th\ JA}$	≤ 310	K/W
Junction - soldering point	$R_{th\ JS}$	≤ 240	

1) For detailed information see chapter Package Outlines.

2) Package mounted on epoxy pcb 40 mm × 40 mm × 1.5 mm/6 cm<sup>2</sup> Cu.

**Electrical Characteristics**

at  $T_A = 25\text{ °C}$ , unless otherwise specified.

Parameter	Symbol	Values			Unit
		min.	typ.	max.	
<b>DC characteristics</b>					
Collector-emitter breakdown voltage $I_C = 1\text{ mA}$	$V_{(BR)CE0}$	50	–	–	V
Collector-base breakdown voltage $I_C = 100\text{ }\mu\text{A}$	$V_{(BR)CB0}$	50	–	–	
Emitter-base breakdown voltage, $I_E = 10\text{ }\mu\text{A}$	$V_{(BR)EB0}$	3	–	–	
Collector-base cutoff current $V_{CB} = 10\text{ V}, I_E = 0$ $V_{CB} = 35\text{ V}, I_E = 0$ $V_{CB} = 35\text{ V}, I_E = 0, T_A = 150\text{ °C}$	$I_{CB0}$	–	–	10 50 20	nA nA $\mu\text{A}$
DC current gain $I_C = 100\text{ }\mu\text{A}, V_{CE} = 5\text{ V}$ $I_C = 1\text{ mA}, V_{CE} = 5\text{ V}$ $I_C = 10\text{ mA}, V_{CE} = 5\text{ V}$	$h_{FE}$	SMBT 5086 SMBT 5087 SMBT 5086 SMBT 5087 SMBT 5086 SMBT 5087	150 250 150 250 150 250	– – – – – –	500 800 – – – –
Collector-emitter saturation voltage <sup>1)</sup> $I_C = 10\text{ mA}, I_B = 1\text{ mA}$	$V_{CEsat}$	–	–	0.3	V
Base-emitter saturation voltage <sup>1)</sup> $I_C = 10\text{ mA}, I_B = 1\text{ mA}$	$V_{BEsat}$	–	–	0.85	

**AC characteristics**

Transition frequency $I_C = 0.5\text{ mA}, V_{CE} = 5\text{ V}, f = 100\text{ MHz}$	$f_T$	40	–	–	MHz
Output capacitance, $V_{CB} = 5\text{ V}, f = 1\text{ MHz}$	$C_{obo}$	–	–	4	pF
Small-signal current gain $I_C = 1\text{ mA}, V_{CE} = 5\text{ V}, f = 1\text{ kHz}$ $I_C = 1\text{ mA}, V_{CE} = 5\text{ V}, f = 1\text{ kHz}$	$h_{te}$	SMBT 5086 SMBT 5087	150 250	– –	600 900
Noise figure $I_C = 100\text{ }\mu\text{A}, V_{CE} = 5\text{ V}, f = 1\text{ kHz},$ $R_s = 3\text{ k}\Omega$ $I_C = 2\text{ mA}, V_{CE} = 5\text{ V}, f = 10\text{ Hz to }15\text{ kHz},$ $R_s = 10\text{ k}\Omega$	$NF$	SMBT 5086 SMBT 5087 SMBT 5086 SMBT 5087	– – – –	– – – –	3 2 3 2 dB dB dB dB

<sup>1)</sup> Pulse test conditions:  $t \leq 300\text{ }\mu\text{s}, D \leq 2\text{ %}$ .

**Total power dissipation  $P_{tot} = f(T_A^*; T_S)$**

\* Package mounted on epoxy

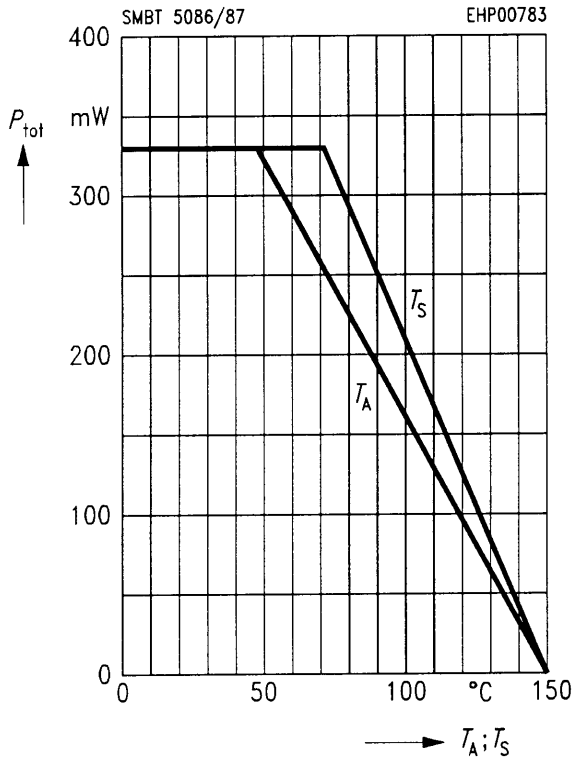

**Collector-base capacitance  $C_{CB0} = f(V_{CB0})$**

**Emitter-base capacitance  $C_{EB0} = f(V_{EB0})$**

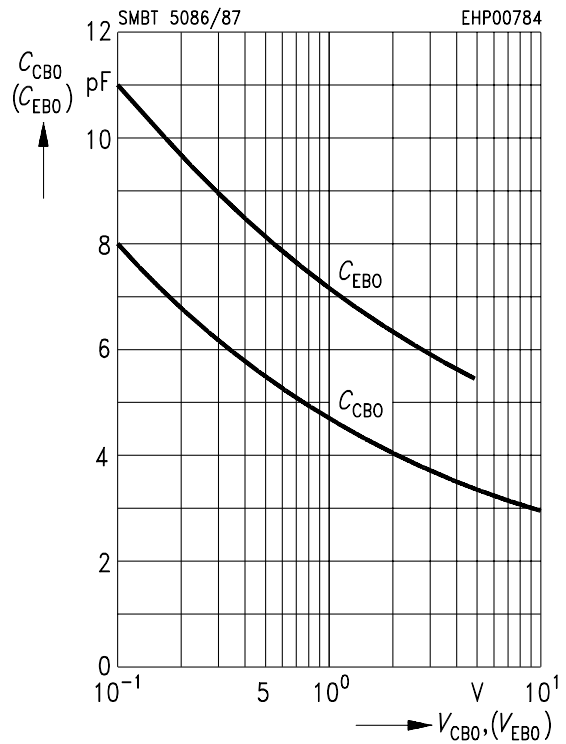

**Permissible pulse load  $P_{tot max}/P_{tot DC} = f(t_p)$**

**Transition frequency  $f_T = f(I_C)$**

$V_{CE} = 5 V$

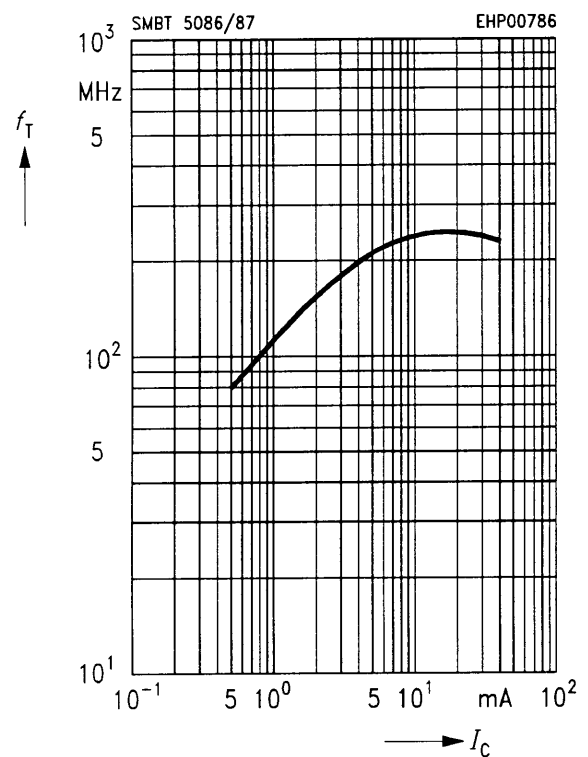
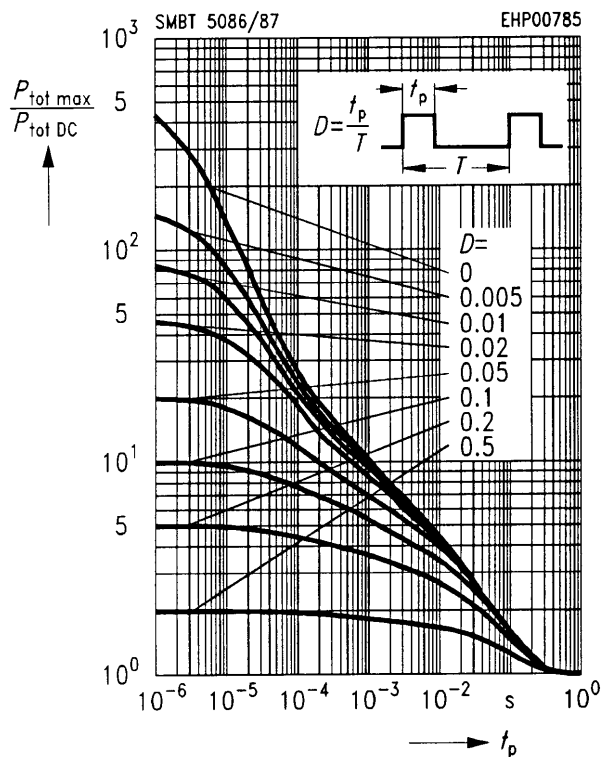

**Base-emitter saturation voltage**

$I_C = f(V_{BE\ sat}), h_{FE} = 40$

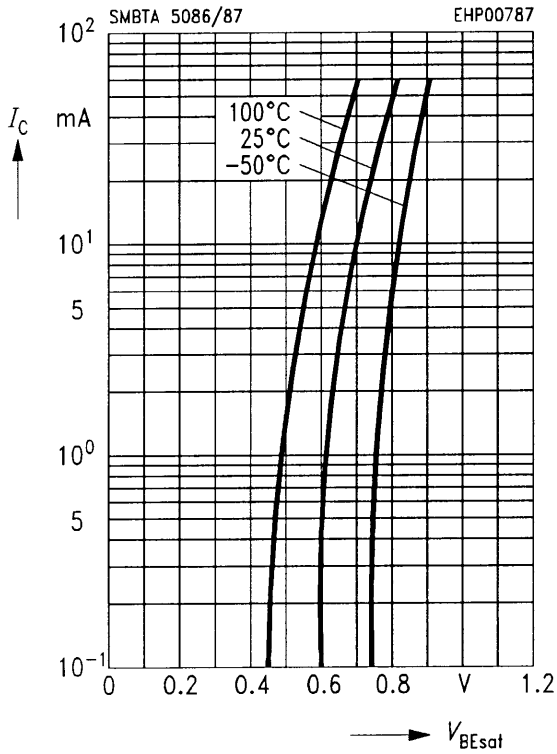

**Collector-emitter saturation voltage**

$I_C = f(V_{CE\ sat}), h_{FE} = 40$

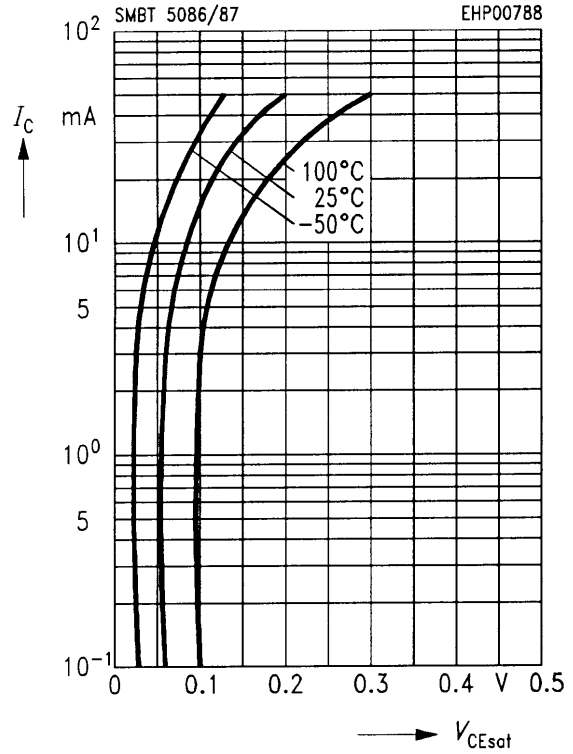

**Collector current  $I_C = f(V_{BE})$**

$V_{CE} = 1\ V$

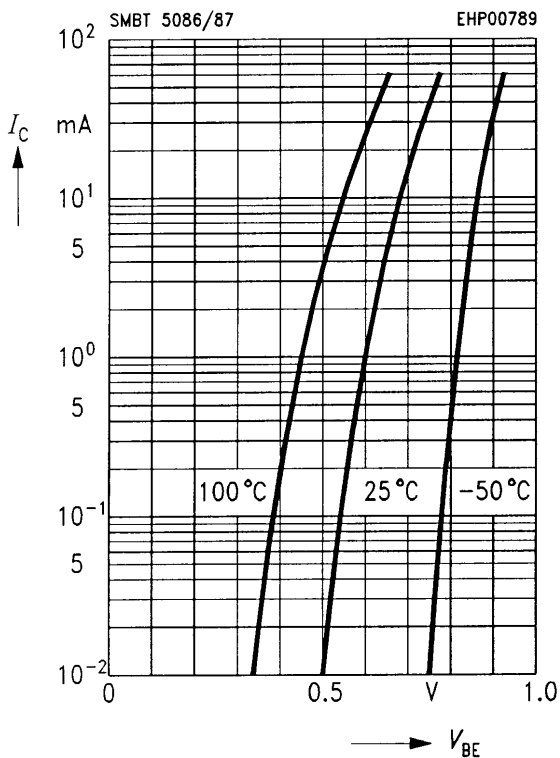

**DC current gain  $h_{FE} = f(I_C)$**

$V_{CE} = 1\ V$

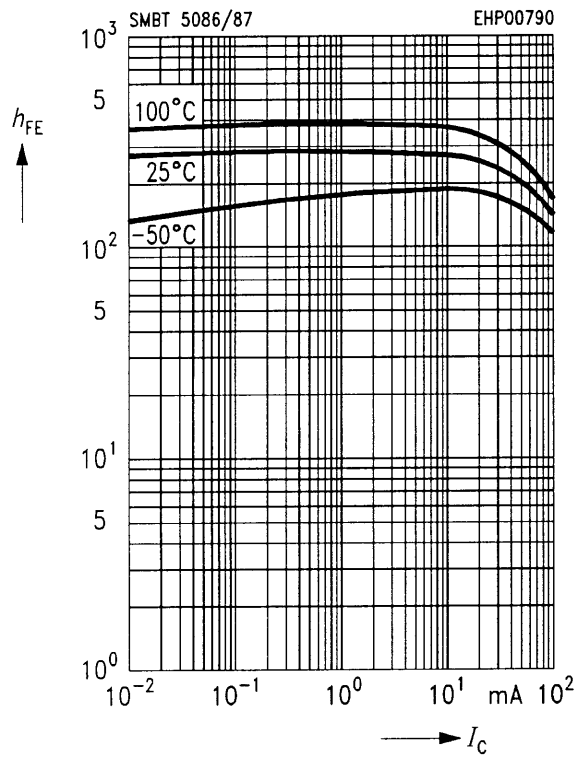

**Collector cutoff current  $I_{CB0} = f(T_A)$**

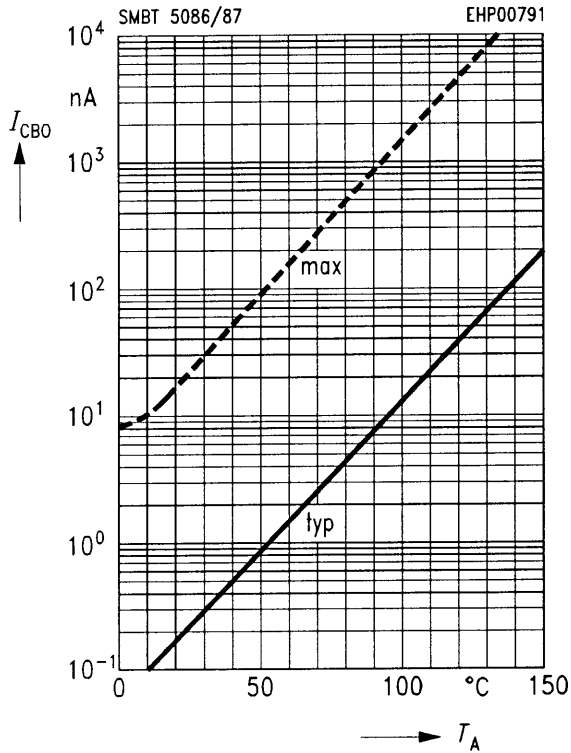

**Noise figure  $NF = f(V_{CE})$**

$I_C = 0.2 \text{ mA}, R_S = 2 \text{ k}\Omega, f = 1 \text{ kHz}$

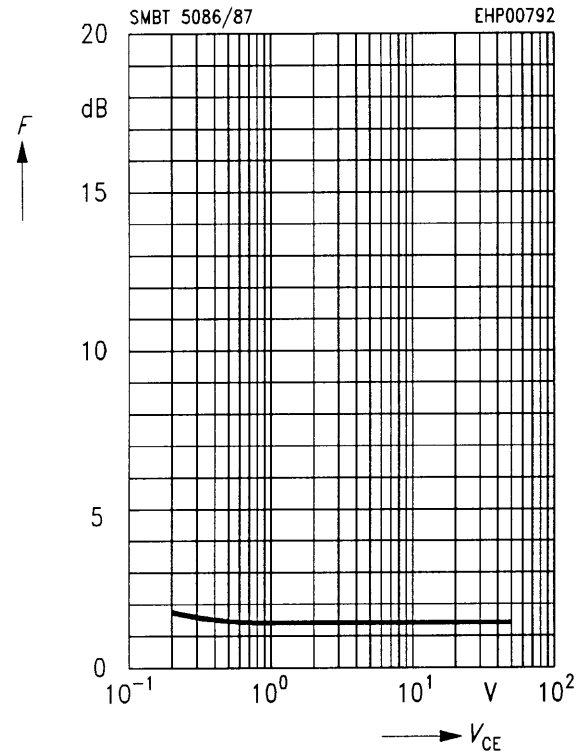

**Noise figure  $NF = f(I_C)$**

$I_C = 0.2 \text{ mA}, R_S = 2 \text{ k}\Omega, V_{CE} = 5 \text{ V}$

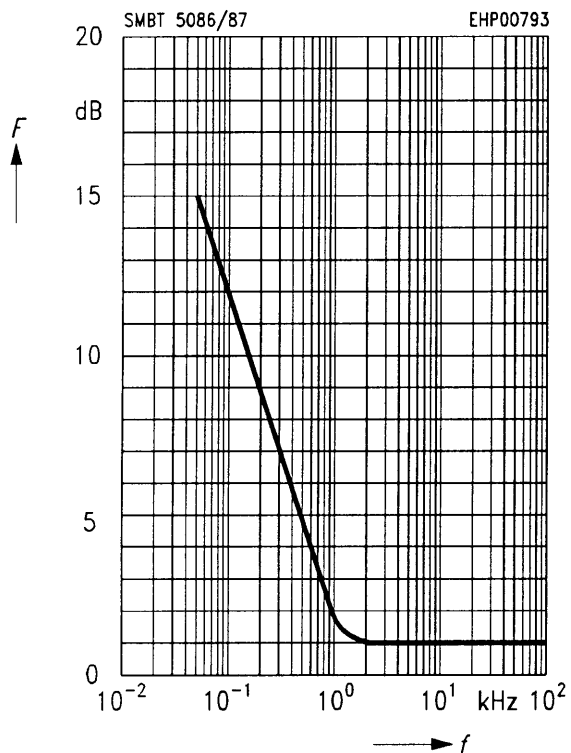

**Noise figure  $NF = f(I_C)$**

$V_{CE} = 5 \text{ V}, f = 120 \text{ kHz}$

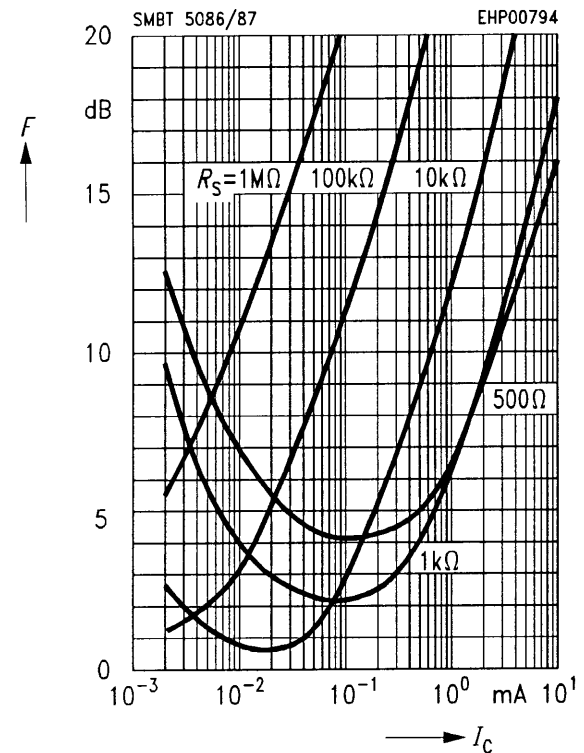

Noise figure  $NF = f(I_C)$

$V_{CE} = 5\text{ V}, f = 1\text{ kHz}$

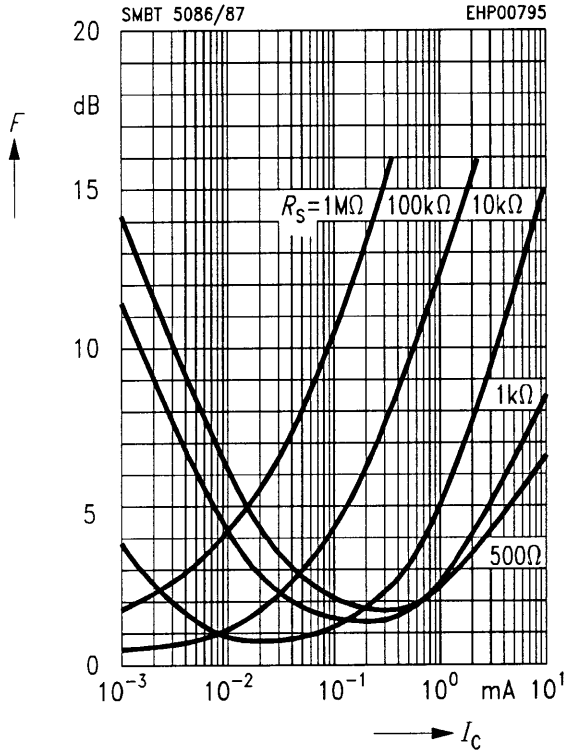

Noise figure  $NF = f(I_C)$

$V_{CE} = 5\text{ V}, f = 10\text{ kHz}$

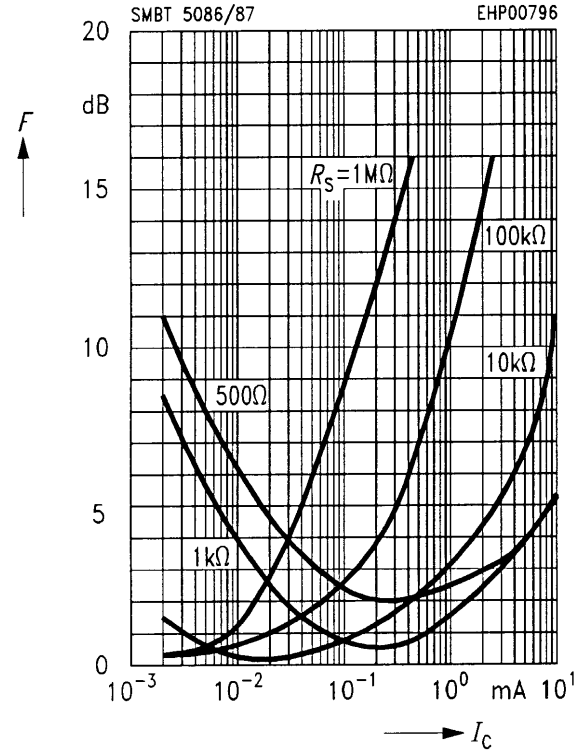

This datasheet has been downloaded from:

[www.DatasheetCatalog.com](http://www.DatasheetCatalog.com)

Datasheets for electronic components.