



Mn-Zn

Ferrite Cores for Switching Power Supplies

Planar series

EL
ELT
PQI
EIR
ER
EI

REMINDERS FOR USING THESE PRODUCTS

Please be sure to read this manual thoroughly before using the products.

The products listed on this catalog are intended for use in general electronic equipment (AV equipment, telecommunications equipment, home appliances, amusement equipment, computer equipment, personal equipment, office equipment, measurement equipment, industrial robots) under a normal operation and use condition.

The products are not designed or warranted to meet the requirements of the applications listed below, whose performance and/or quality require a more stringent level of safety or reliability, or whose failure, malfunction or trouble could cause serious damage to society, person or property.

When using the products for specific purposes, please first make confirmations in areas such as safety, reliability, and quality.

Please understand that we are not in a position to be held responsible for any damage or the like caused by any use exceeding the range or conditions of this specification sheet or by any use in the specific applications.

- | | |
|---|--|
| (1) Aerospace/Aviation equipment | (8) Public information-processing equipment |
| (2) Transportation equipment (electric trains, ships, etc.) | (9) Military equipment |
| (3) Medical equipment | (10) Electric heating apparatus, burning equipment |
| (4) Power-generation control equipment | (11) Disaster prevention/crime prevention equipment |
| (5) Atomic energy-related equipment | (12) Safety equipment |
| (6) Seabed equipment | (13) Other applications that are not considered general-purpose applications |
| (7) Transportation control equipment | |

When using this product in general-purpose standard applications, you are kindly requested to take into consideration securing protection circuit/equipment or providing backup circuits, etc to ensure higher safety.

Ferrite Cores for Switching Power Supplies

Product compatible with RoHS directive
Halogen-free

Overview of the Planar Series

FEATURES

- Low profile shape suited to PCB mounting
- Available in a range of various shapes
- Available in a pair of E core and I core that easily can be mounted on PCBs
- A wide range of sizes is available from 10mm to 25mm

APPLICATION

Low profile DC/DC converters, transformers and coils for use in planers

PART NUMBER CONSTRUCTION

PC90	EL11X4	-	Z				
Material	Size of E core	AL-value (Z: without air gap)					
PC90 PC95							
	EL core						
	EL11X4	EL13X4.4	EL15.5X5.8	EL18X7.3	EL20X7.7	EL22X8	EL25X8.6
	ELT core						
	ELT11X3	ELT11X4	ELT13X3.4	ELT13X4.4	ELT15.5X4.3	ELT15.5X5.8	ELT18X5.3
	ELT18X7.3	ELT20X5.7	ELT20X7.7	ELT22X6	ELT22X8	ELT25X6.6	ELT25X8.6
	PQI core						
	PQI16/7.8Z	PQI20/9Z	PQI26/12Z				
	EIR core						
	EIR14/4.5/9	EIR18/5/12	EIR22/5.5/15				
	ER core						
	ER9.5/5	ER11/5	ER14/4.5/9	ER14.5/6	ER18/5/12	ER22/5.5/15	ER25/5.5/18
	EI core						
	EI14/5/5	EI18/6/10	EI22/8/16				

RANGE OF USE AND STORAGE TEMPERATURE

Temperature range	
Operating temperature (°C)	Storage temperature (°C)
-30 to +105	-30 to +85

- RoHS Directive Compliant Product: See the following for more details. <https://product.tdk.com/info/en/environment/rohs/index.html>
- Halogen-free: Indicates that Cl content is less than 900ppm, Br content is less than 900ppm, and that the total Cl and Br content is less than 1500ppm.

 Please be sure to request delivery specifications that provide further details on the features and specifications of the products for proper and safe use. Please note that the contents may change without any prior notice due to reasons such as upgrading.

Mn-Zn EL Cores

SHAPES AND DIMENSIONS

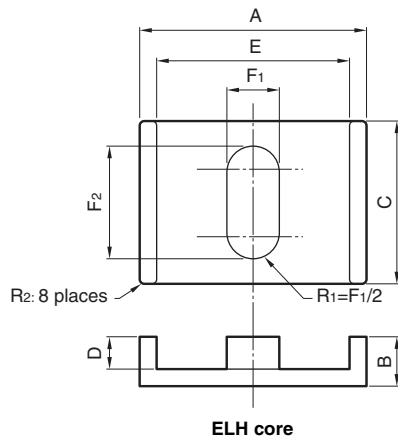

PC95	EL11X4	-	Z
Material	Size of E core		AL-value (Z: without air gap)

Part No.(ELH+ELH)	Dimensions (mm)							
	A	B	C	D	E	F ₁	F ₂	R ₂
PC95EL11X4-Z	11.00±0.20	2.01±0.10	8.80±0.20	1.00±0.10	9.17±0.20	2.78±0.10	6.40±0.15	0.30
PC90EL11X4-Z								
PC95EL13X4.4-Z	13.00±0.25	2.19±0.10	10.40±0.20	1.00±0.10	10.83±0.20	3.29±0.10	7.56±0.15	0.30
PC90EL13X4.4-Z								
PC95EL15.5X5.8-Z	15.50±0.30	2.92±0.10	12.40±0.25	1.50±0.10	12.92±0.25	3.92±0.10	9.01±0.20	0.30
PC90EL15.5X5.8-Z								
PC95EL18X7.3-Z	18.00±0.30	3.65±0.10	14.40±0.25	2.00±0.10	15.00±0.30	4.55±0.10	10.47±0.20	0.30
PC90EL18X7.3-Z								
PC95EL20X7.7-Z	20.00±0.35	3.83±0.10	16.00±0.30	2.00±0.10	16.67±0.30	5.06±0.15	11.63±0.20	0.50
PC90EL20X7.7-Z								
PC95EL22X8-Z	22.00±0.40	4.02±0.10	17.60±0.30	2.00±0.10	18.33±0.35	5.56±0.15	12.79±0.25	0.50
PC90EL22X8-Z								
PC95EL25X8.6-Z	25.00±0.45	4.29±0.10	20.00±0.35	2.00±0.10	20.83±0.35	6.32±0.15	14.54±0.25	0.50
PC90EL25X8.6-Z								

Part No.(ELH+ELH)	Effective parameter							Electrical characteristics	
	Core factor C ₁ (mm ⁻¹)	Effective magnetic path length ℓ _e (mm)	Effective cross-sectional area A _e (mm ²)	Effective core volume V _e (mm ³)	A _{min} . (mm ²)	A _{cw} (mm ²)	Weigh (g)	AL-value (nH/N ²) 1kHz 0.5mA 100Ts Without air gap With air gap	
PC95EL11X4-Z	0.826	13.7	16.5	226	15.9	6.39	1.3	2400±25%	50±3%
PC90EL11X4-Z								1950±25%	80±5% 125±7%
PC95EL13X4.4-Z	0.667	15.4	23.1	357	22.4	7.54	2.0	3160±25%	63±3%
PC90EL13X4.4-Z								2500±25%	100±5% 160±7%
PC95EL15.5X5.8-Z	0.597	19.6	32.9	646	31.9	13.5	3.5	3680±25%	63±3%
PC90EL15.5X5.8-Z								3000±25%	100±3% 160±5%
PC95EL18X7.3-Z	0.538	23.8	44.3	1050	43.0	20.9	6.0	4760±25%	80±3%
PC90EL18X7.3-Z								3600±25%	125±3% 200±5%
PC95EL20X7.7-Z	0.469	25.6	54.6	1400	52.9	23.2	7.8	5630±25%	80±3%
PC90EL20X7.7-Z								4050±25%	125±3% 200±5%
PC95EL22X8-Z	0.413	27.3	66.2	1810	64.2	25.5	10	6540±25%	100±3%
PC90EL22X8-Z								5050±25%	160±3% 250±5%
PC95EL25X8.6-Z	0.350	30.0	85.6	2570	83.0	29.0	15	7540±25%	100±3%
PC90EL25X8.6-Z								5700±25%	160±3% 250±5%

⚠ Please be sure to request delivery specifications that provide further details on the features and specifications of the products for proper and safe use.
Please note that the contents may change without any prior notice due to reasons such as upgrading.

Mn-Zn Planar series Part No.: PC90EL11X4-Z

SHAPES AND DIMENSIONS

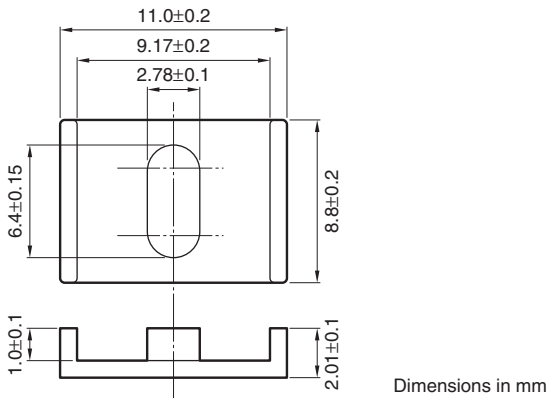

Effective parameter						Electrical characteristics	
Core factor	Effective magnetic path length	Effective cross-sectional area	Effective core volume	Cross-sectional winding area of core	Weight	AL-value *	Core loss
C_1 (mm ⁻¹)	ℓ_e (mm)	A_e (mm ²)	V_e (mm ³)	A_{cw} (mm ²)	(g/set)	(nH/N ²) 1kHz 0.5mA	(W)max. 100kHz 200mT 100°C
0.826	13.7	16.5	226	6.39	1.3	1950±25%	0.2

NI limit vs. AL-value (Typ.)

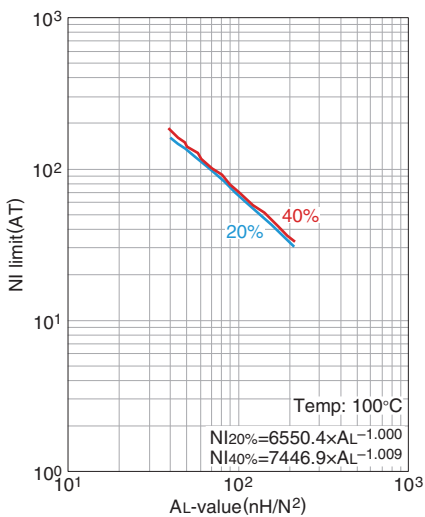

The 20% and 40% graph shows when a 20% and 40% drop from the initial AL-value has been made due to the DC superimposition.

AL-value vs. Air gap length (Typ.)

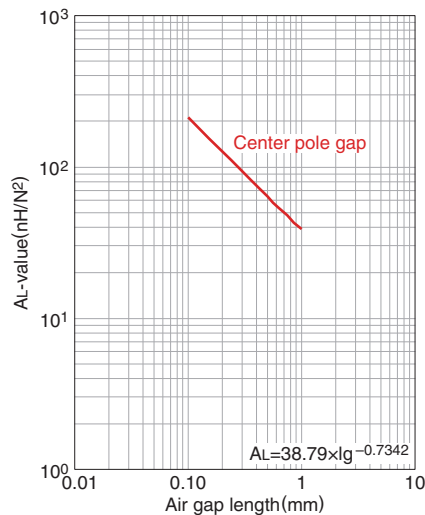

Measuring conditions

- Coil : $\phi 0.18$ 2UEW 100Ts
- Frequency : 1kHz
- Current level : 0.5mA
- Ambient temperature : 25°C

Mn-Zn Planar series Part No.: PC95EL11X4-Z

SHAPES AND DIMENSIONS

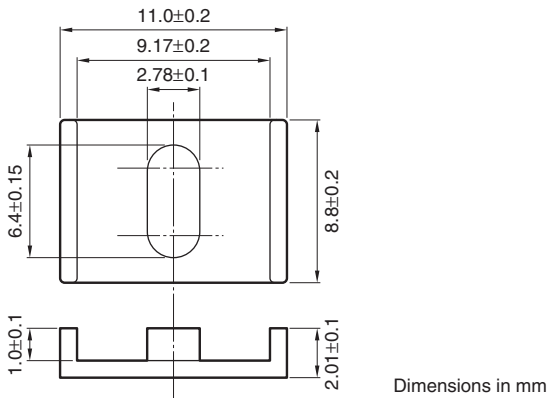

Effective parameter						Electrical characteristics				
Core factor	Effective magnetic path length	Effective cross-sectional area	Effective core volume	Cross-sectional winding area of core	Weigh	AL-value *	Core loss			
C_1 (mm ⁻¹)	ℓ_e (mm)	A_e (mm ²)	V_e (mm ³)	A_{cw} (mm ²)	(g/set)	(nH/N ²) 1kHz 0.5mA	(W)max. 100kHz 200mT	25°C	80°C	120°C
0.826	13.7	16.5	226	6.39	1.3	2400±25%	0.2	0.18	0.2	

NI limit vs. AL-value (Typ.)

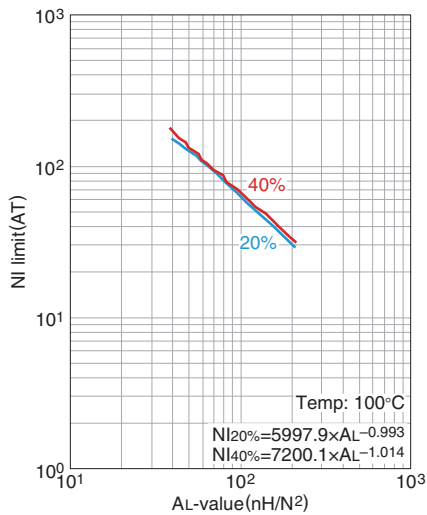

The 20% and 40% graph shows when a 20% and 40% drop from the initial AL-value has been made due to the DC superimposition.

AL-value vs. Air gap length (Typ.)

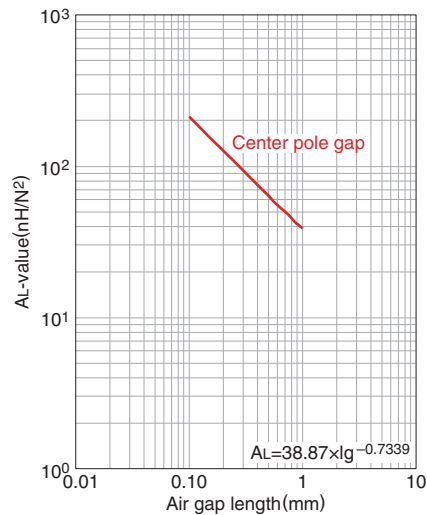

Measuring conditions

- Coil : $\phi 0.18$ 2UEW 100Ts
- Frequency : 1kHz
- Current level : 0.5mA
- Ambient temperature : 25°C

Mn-Zn Planar series Part No.: PC90EL13X4.4-Z

SHAPES AND DIMENSIONS

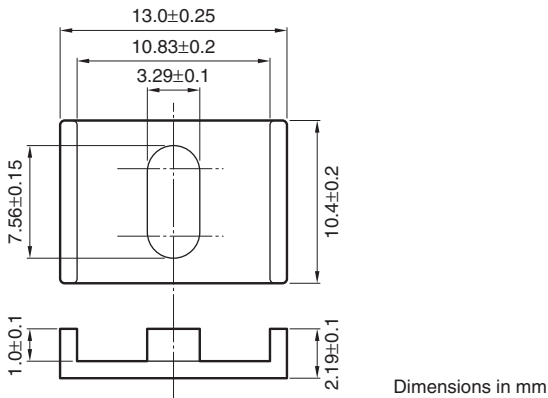

Effective parameter						Electrical characteristics	
Core factor	Effective magnetic path length	Effective cross-sectional area	Effective core volume	Cross-sectional winding area of core	Weight	AL-value *	Core loss
C_1 (mm ⁻¹)	ℓ_e (mm)	A_e (mm ²)	V_e (mm ³)	A_{cw} (mm ²)	(g/set)	(nH/N ²) 1kHz 0.5mA	(W)max. 100kHz 200mT 100°C
0.667	15.4	23.1	357	7.54	2.0	2500±25%	0.25

NI limit vs. AL-value (Typ.)

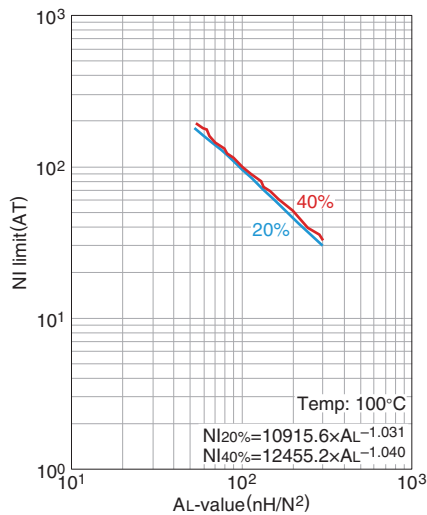

The 20% and 40% graph shows when a 20% and 40% drop from the initial AL-value has been made due to the DC superimposition.

AL-value vs. Air gap length (Typ.)

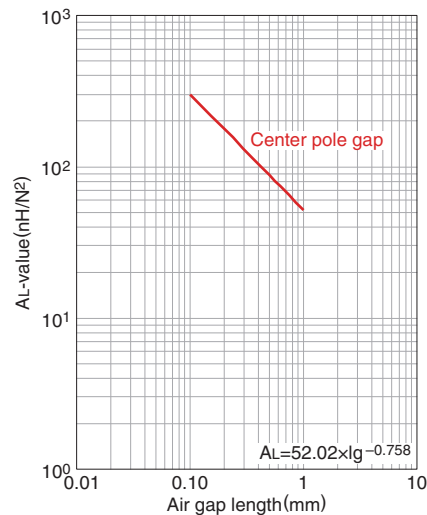

Measuring conditions

- Coil : $\phi 0.18$ 2UEW 100Ts
- Frequency : 1kHz
- Current level : 0.5mA
- Ambient temperature : 25°C

Mn-Zn Planar series Part No.: PC95EL13X4.4-Z

■ SHAPES AND DIMENSIONS

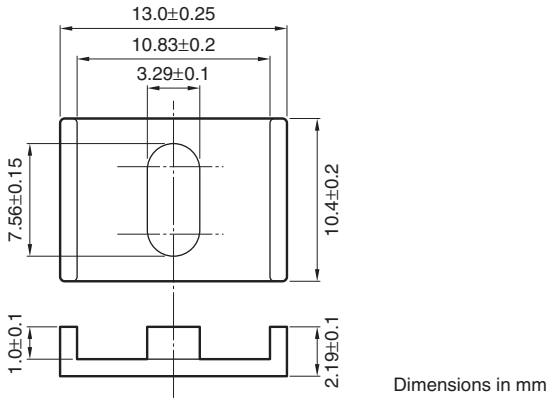

Effective parameter						Electrical characteristics			
Core factor	Effective magnetic path length	Effective cross-sectional area	Effective core volume	Cross-sectional winding area of core	Weight	AL-value *	Core loss		
C ₁ (mm ⁻¹)	ℓ _e (mm)	A _e (mm ²)	V _e (mm ³)	A _{cw} (mm ²)	(g/set)	(nH/N ²) 1kHz 0.5mA	(W)max. 100kHz 200mT		
0.667	15.4	23.1	357	7.54	2.0	3160±25%	25°C	80°C	120°C
							0.25	0.2	0.25

NI limit vs. AL-value (Typ.)

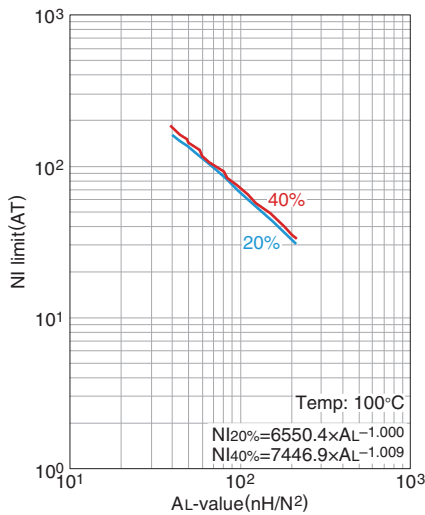

The 20% and 40% graph shows when a 20% and 40% drop from the initial AL-value has been made due to the DC superimposition.

AL-value vs. Air gap length (Typ.)

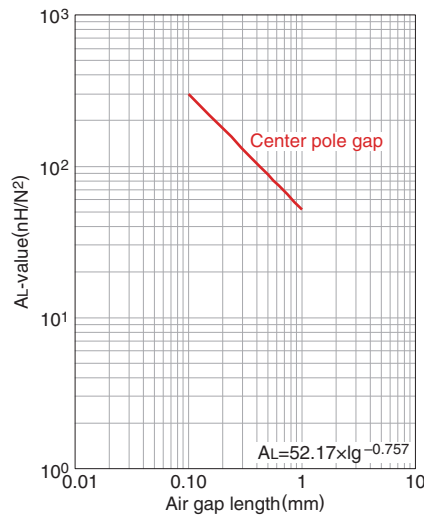

- Measuring conditions
- Coil : ø0.18 2UEW 100Ts
 - Frequency : 1kHz
 - Current level : 0.5mA
 - Ambient temperature : 25°C

Please be sure to request delivery specifications that provide further details on the features and specifications of the products for proper and safe use. Please note that the contents may change without any prior notice due to reasons such as upgrading.

Mn-Zn Planar series Part No.: PC90EL15.5X5.8-Z

■ SHAPES AND DIMENSIONS

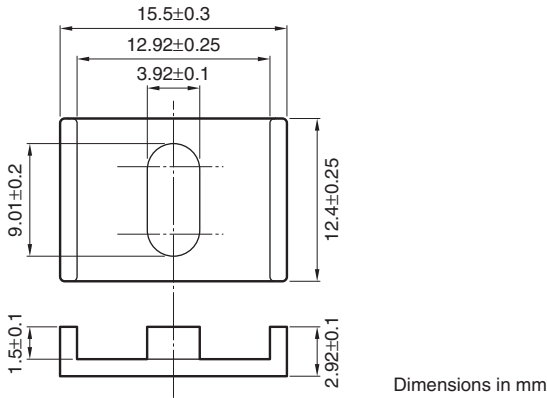

Effective parameter						Electrical characteristics	
Core factor	Effective magnetic path length	Effective cross-sectional area	Effective core volume	Cross-sectional winding area of core	Weigh	AL-value *	Core loss
C ₁ (mm ⁻¹)	ℓ _e (mm)	A _e (mm ²)	V _e (mm ³)	A _{cw} (mm ²)	(g/set)	(nH/N ²) 1kHz 0.5mA	(W)max. 100kHz 200mT 100°C
0.597	19.6	32.9	646	13.5	3.5	3000±25%	0.5

NI limit vs. AL-value (Typ.)

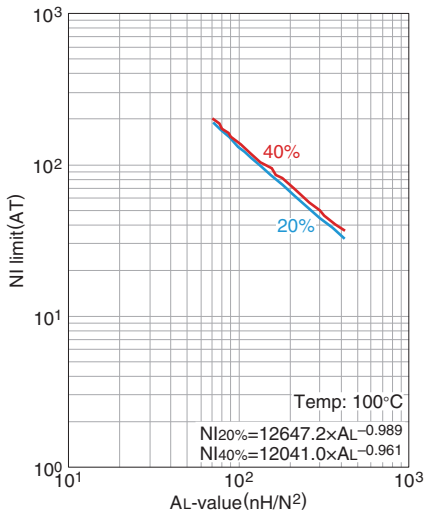

The 20% and 40% graph shows when a 20% and 40% drop from the initial AL-value has been made due to the DC superimposition.

AL-value vs. Air gap length (Typ.)

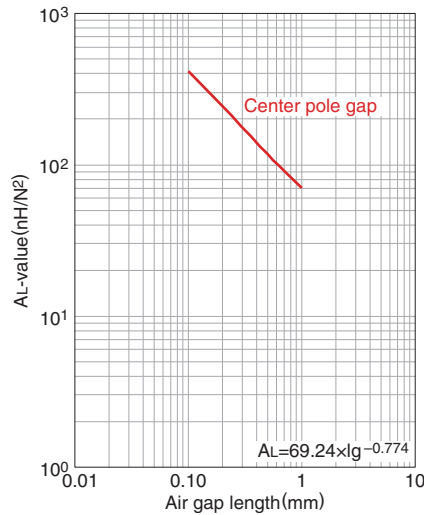

- Measuring conditions
- Coil : ø0.18 2UEW 100Ts
 - Frequency : 1kHz
 - Current level : 0.5mA
 - Ambient temperature : 25°C

⚠ Please be sure to request delivery specifications that provide further details on the features and specifications of the products for proper and safe use. Please note that the contents may change without any prior notice due to reasons such as upgrading.

Mn-Zn Planar series **Part No.: PC95EL15.5X5.8-Z**

■ SHAPES AND DIMENSIONS

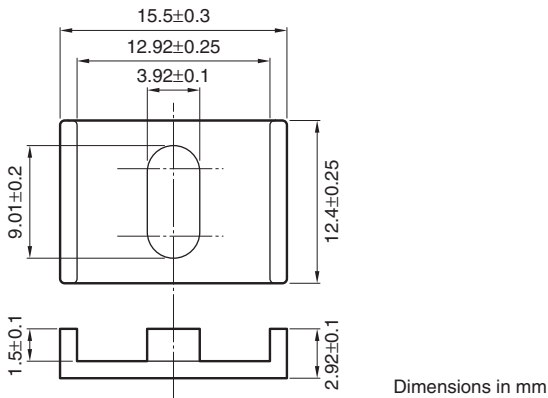

Effective parameter						Electrical characteristics			
Core factor	Effective magnetic path length	Effective cross-sectional area	Effective core volume	Cross-sectional winding area of core	Weight	AL-value *	Core loss		
C_1 (mm ⁻¹)	ℓ_e (mm)	A_e (mm ²)	V_e (mm ³)	A_{cw} (mm ²)	(g/set)	(nH/N ²) 1kHz 0.5mA	(W)max. 100kHz 200mT 25°C	80°C	120°C
0.597	19.6	32.9	646	13.5	3.5	3680±25%	0.5	0.45	0.5

NI limit vs. AL-value (Typ.)

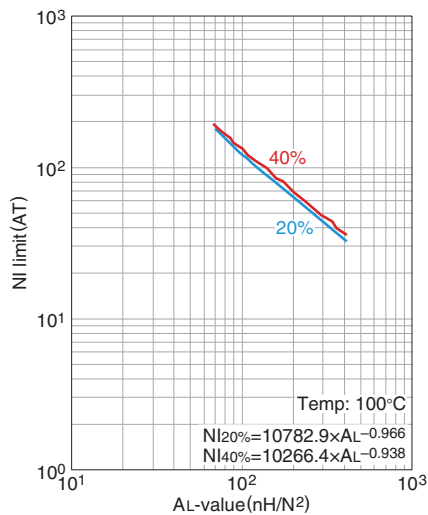

The 20% and 40% graph shows when a 20% and 40% drop from the initial AL-value has been made due to the DC superimposition.

AL-value vs. Air gap length (Typ.)

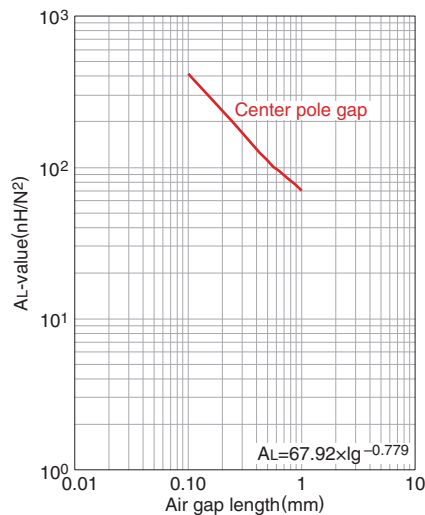

Measuring conditions

- Coil : $\phi 0.18$ 2UEW 100Ts
- Frequency : 1kHz
- Current level : 0.5mA
- Ambient temperature : 25°C

Mn-Zn ELT Cores

SHAPES AND DIMENSIONS

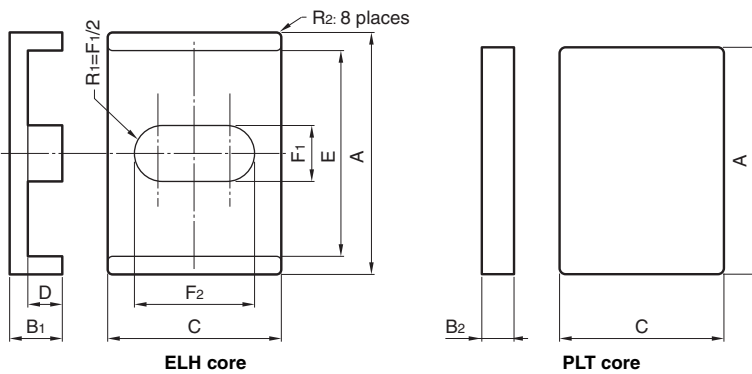

PC95	ELT11X3	-	Z
Material	Size of E core		AL-value (Z: without air gap)

Part No.(ELH+PLT)	Dimensions (mm)								
	A	B ₁	B ₂	C	D	E	F ₁	F ₂	R ₂
PC95ELT11X3-Z	11.00±0.20	2.01±0.10	1.01±0.05	8.80±0.20	1.00±0.10	9.17±0.20	2.78±0.10	6.40±0.15	0.30
PC90ELT11X3-Z									
PC95ELT11X4-Z	11.00±0.20	3.01±0.10	1.01±0.05	8.80±0.20	2.00±0.10	9.17±0.20	2.78±0.10	6.40±0.15	0.30
PC90ELT11X4-Z									
PC95ELT13X3.4-Z	13.00±0.25	2.19±0.10	1.19±0.05	10.40±0.20	1.00±0.10	10.83±0.20	3.29±0.10	7.56±0.15	0.30
PC90ELT13X3.4-Z									
PC95ELT13X4.4-Z	13.00±0.25	3.19±0.10	1.19±0.05	10.40±0.20	2.00±0.10	10.83±0.20	3.29±0.10	7.56±0.15	0.30
PC90ELT13X4.4-Z									
PC95ELT15.5X4.3-Z	15.50±0.30	2.92±0.10	1.42±0.10	12.40±0.25	1.50±0.10	12.92±0.25	3.92±0.10	9.01±0.20	0.30
PC90ELT15.5X4.3-Z									
PC95ELT15.5X5.8-Z	15.50±0.30	4.42±0.10	1.42±0.10	12.40±0.25	3.00±0.10	12.92±0.25	3.92±0.10	9.01±0.20	0.30
PC90ELT15.5X5.8-Z									
PC95ELT18X5.3-Z	18.00±0.30	3.65±0.10	1.65±0.10	14.40±0.25	2.00±0.10	15.00±0.30	4.55±0.10	10.47±0.20	0.30
PC90ELT18X5.3-Z									

Part No.(ELH+ELH)	Effective parameter							Electrical characteristics	
	Core factor C ₁ (mm ⁻¹)	Effective magnetic path length ℓ _e (mm)	Effective cross-sectional area A _e (mm ²)	Effective core volume V _e (mm ³)	A _{min} . (mm ²)	A _{cw} (mm ²)	Weigh (g)	AL-value (nH/N ²) 1kHz 0.5mA 100Ts	
								Without air gap	With air gap
PC95ELT11X3-Z	0.702	11.7	16.6	194	15.9	3.20	1.1	2590±25%	50±3%
PC90ELT11X3-Z								1750±25%	80±5%
PC95ELT11X4-Z	0.826	13.7	16.5	226	15.9	6.39	1.3	2400±25%	50±3%
PC90ELT11X4-Z								1700±25%	80±5%
PC95ELT13X3.4-Z	0.578	13.4	23.2	312	22.4	3.77	1.8	3390±25%	63±3%
PC90ELT13X3.4-Z								2400±25%	100±5%
PC95ELT13X4.4-Z	0.667	15.4	23.1	357	22.4	7.54	2.0	3160±25%	63±3%
PC90ELT13X4.4-Z								2300±25%	100±5%
PC95ELT15.5X4.3-Z	0.503	16.6	33.1	550	31.9	6.75	3.0	4340±25%	63±3%
PC90ELT15.5X4.3-Z								2900±25%	100±3%
PC95ELT15.5X5.8-Z	0.597	19.6	32.9	646	31.9	13.5	3.5	3680±25%	63±3%
PC90ELT15.5X5.8-Z								2200±25%	100±3%
PC95ELT18X5.3-Z	0.446	19.8	44.5	882	43.0	10.5	5.0	5330±25%	80±3%
PC90ELT18X5.3-Z								3500±25%	125±3%

⚠ Please be sure to request delivery specifications that provide further details on the features and specifications of the products for proper and safe use.
Please note that the contents may change without any prior notice due to reasons such as upgrading.

Mn-Zn ELT Cores

SHAPES AND DIMENSIONS

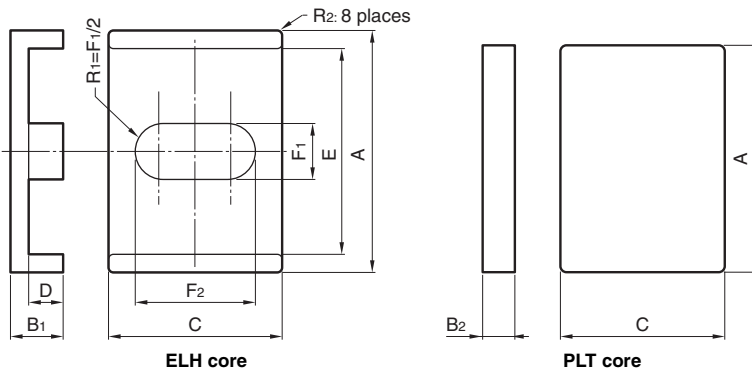

PC95	ELT18X7.3	-	Z
Material	Size of E core		AL-value (Z: without air gap)

Part No.(ELH+PLT)	Dimensions (mm)								
	A	B ₁	B ₂	C	D	E	F ₁	F ₂	R ₂
PC95ELT18X7.3-Z	18.00±0.30	5.65±0.10	1.65±0.10	14.40±0.25	4.00±0.15	15.00±0.30	4.55±0.10	10.47±0.20	0.30
PC90ELT18X7.3-Z									
PC95ELT20X5.7-Z	20.00±0.35	3.83±0.10	1.83±0.10	16.00±0.30	2.00±0.10	16.67±0.30	5.06±0.15	11.63±0.20	0.50
PC90ELT20X5.7-Z									
PC95ELT20X7.7-Z	20.00±0.35	5.83±0.15	1.83±0.10	16.00±0.30	4.00±0.15	16.67±0.30	5.06±0.15	11.63±0.20	0.50
PC90ELT20X7.7-Z									
PC95ELT22X6-Z	22.00±0.40	4.02±0.10	2.02±0.10	17.60±0.30	2.00±0.10	18.33±0.35	5.56±0.15	12.79±0.25	0.50
PC90ELT22X6-Z									
PC95ELT22X8-Z	22.00±0.40	6.02±0.15	2.02±0.10	17.60±0.30	4.00±0.15	18.33±0.35	5.56±0.15	12.79±0.25	0.50
PC90ELT22X8-Z									
PC95ELT25X6.6-Z	25.00±0.45	4.29±0.10	2.29±0.10	20.00±0.35	2.00±0.10	20.83±0.35	6.32±0.15	14.54±0.25	0.50
PC90ELT25X6.6-Z									
PC95ELT25X8.6-Z	25.00±0.45	6.29±0.15	2.29±0.10	20.00±0.35	4.00±0.15	20.83±0.35	6.32±0.15	14.54±0.25	0.50
PC90ELT25X8.6-Z									

Part No.(ELH+ELH)	Effective parameter							Electrical characteristics	
	Core factor C ₁ (mm ⁻¹)	Effective magnetic path length ℓ _e (mm)	Effective cross-sectional area A _e (mm ²)	Effective core volume V _e (mm ³)	A _{min} . (mm ²)	A _{cw} (mm ²)	Weigh (g)	AL-value (nH/N ²) 1kHz 0.5mA 100Ts	
PC95ELT18X7.3-Z	0.538	23.8	44.3	1050	43.0	20.9	6.0	4760±25%	80±3%
PC90ELT18X7.3-Z								3100±25%	125±3%
PC95ELT20X5.7-Z	0.393	21.6	54.9	1180	52.9	11.6	6.7	6270±25%	80±3%
PC90ELT20X5.7-Z								4150±25%	125±3%
PC95ELT20X7.7-Z	0.469	25.6	54.6	1400	52.9	23.2	7.8	5630±25%	80±3%
PC90ELT20X7.7-Z								3900±25%	125±3%
PC95ELT22X6-Z	0.351	23.4	66.6	1560	64.2	12.8	9.0	7250±25%	100±3%
PC90ELT22X6-Z								4800±25%	160±3%
PC95ELT22X8-Z	0.413	27.3	66.2	1810	64.2	25.5	10	6540±25%	100±3%
PC90ELT22X8-Z								4250±25%	160±3%
PC95ELT25X6.6-Z	0.302	26.0	86.0	2230	83.0	14.5	13	8600±25%	100±3%
PC90ELT25X6.6-Z								6100±25%	160±3%
PC95ELT25X8.6-Z	0.350	30.0	85.6	2570	83.0	29.0	15	7540±25%	100±3%
PC90ELT25X8.6-Z								5400±25%	160±3%

⚠ Please be sure to request delivery specifications that provide further details on the features and specifications of the products for proper and safe use.
Please note that the contents may change without any prior notice due to reasons such as upgrading.

Mn-Zn Planar series Part No.: PC90ELT11X3-Z

SHAPES AND DIMENSIONS

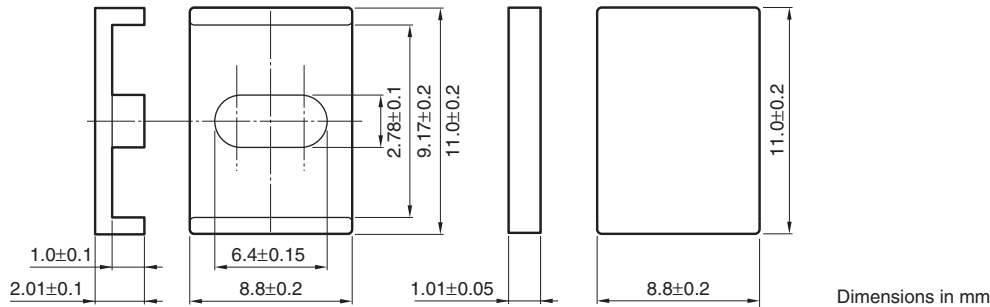

Effective parameter						Electrical characteristics	
Core factor	Effective magnetic path length	Effective cross-sectional area	Effective core volume	Cross-sectional winding area of core	Weight	AL-value *	Core loss
C_1 (mm ⁻¹)	ℓ_e (mm)	A_e (mm ²)	V_e (mm ³)	A_{cw} (mm ²)	(g/set)	(nH/N ²) 1kHz 0.5mA	(W)max. 100kHz 200mT 100°C
0.702	11.7	16.6	194	3.20	1.1	1750±25%	0.15

NI limit vs. AL-value (Typ.)

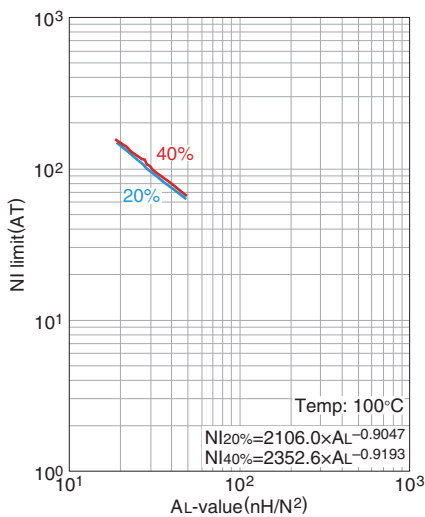

The 20% and 40% graph shows when a 20% and 40% drop from the initial AL-value has been made due to the DC superimposition.

AL-value vs. Air gap length (Typ.)

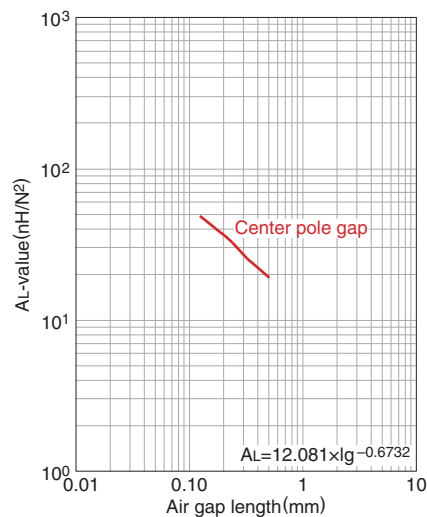

Measuring conditions

- Coil : $\phi 0.18$ 2UEW 100Ts
- Frequency : 1kHz
- Current level : 0.5mA
- Ambient temperature : 25°C

Mn-Zn Planar series Part No.: PC95ELT11X3-Z

SHAPES AND DIMENSIONS

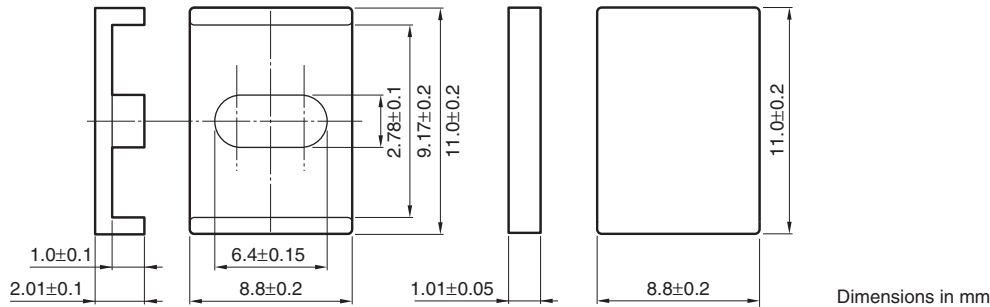

Effective parameter						Electrical characteristics			
Core factor	Effective magnetic path length	Effective cross-sectional area	Effective core volume	Cross-sectional winding area of core	Weight	AL-value *	Core loss		
C_1 (mm ⁻¹)	ℓ_e (mm)	A_e (mm ²)	V_e (mm ³)	A_{cw} (mm ²)	(g/set)	(nH/N ²) 1kHz 0.5mA	(W)max. 100kHz 200mT 25°C	80°C	120°C
0.702	11.7	16.6	194	3.20	1.1	2590±25%	0.14	0.12	0.14

NI limit vs. AL-value (Typ.)

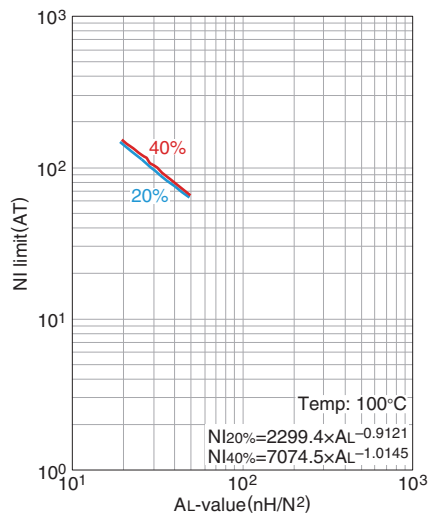

The 20% and 40% graph shows when a 20% and 40% drop from the initial AL-value has been made due to the DC superimposition.

AL-value vs. Air gap length (Typ.)

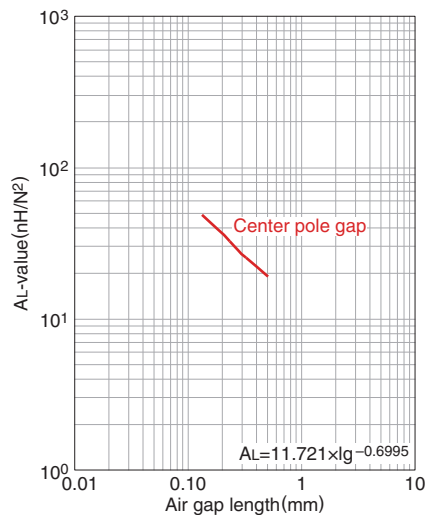

Measuring conditions

- Coil : $\phi 0.18$ 2UEW 100Ts
- Frequency : 1kHz
- Current level : 0.5mA
- Ambient temperature : 25°C

Mn-Zn Planar series Part No.: PC90ELT11X4-Z

SHAPES AND DIMENSIONS

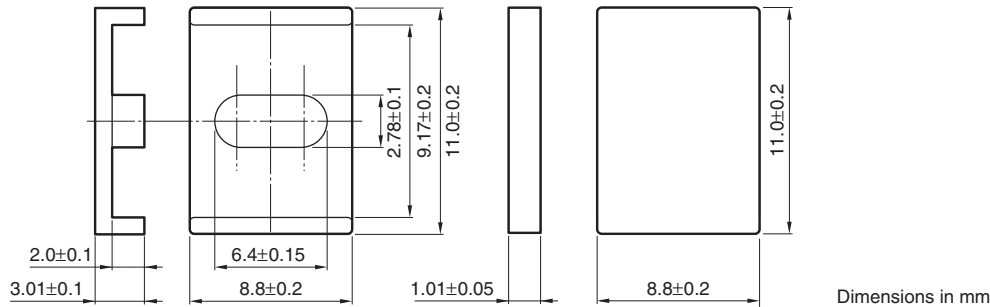

Dimensions in mm

Effective parameter						Electrical characteristics	
Core factor	Effective magnetic path length	Effective cross-sectional area	Effective core volume	Cross-sectional winding area of core	Weigh	AL-value *	Core loss
C_1 (mm^{-1})	ℓ_e (mm)	A_e (mm^2)	V_e (mm^3)	A_{cw} (mm^2)	(g/set)	(nH/N^2) 1kHz 0.5mA	(W)max. 100kHz 200mT 100°C
0.826	13.7	16.5	226	6.39	1.3	1700±25%	0.18

NI limit vs. AL-value (Typ.)

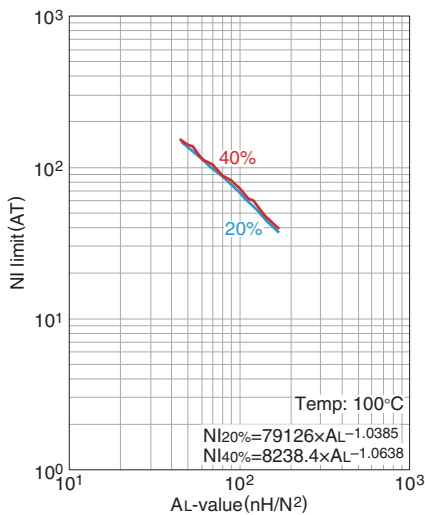

The 20% and 40% graph shows when a 20% and 40% drop from the initial AL-value has been made due to the DC superimposition.

AL-value vs. Air gap length (Typ.)

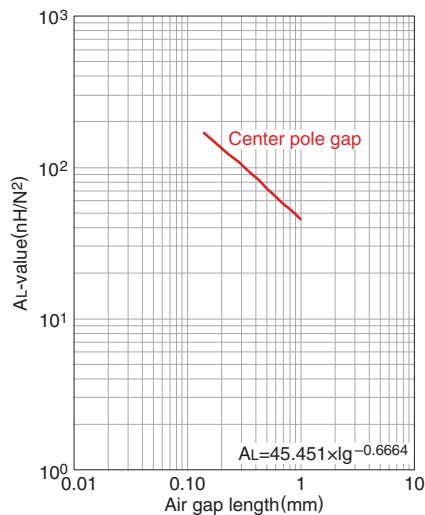

Measuring conditions

- Coil : $\phi 0.18$ 2UEW 100Ts
- Frequency : 1kHz
- Current level : 0.5mA
- Ambient temperature : 25°C

Mn-Zn Planar series Part No.: PC95ELT11X4-Z

SHAPES AND DIMENSIONS

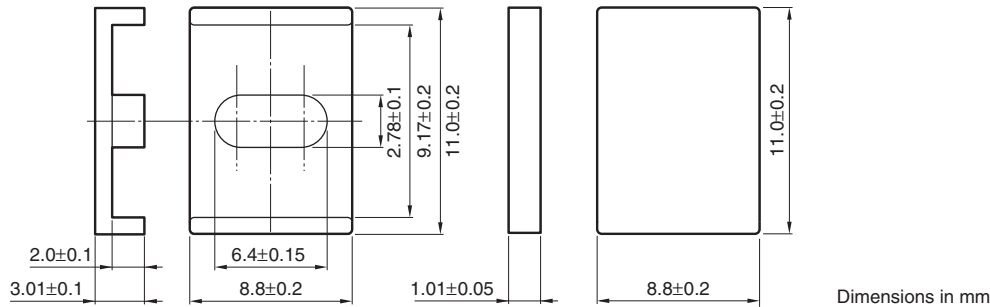

Dimensions in mm

Effective parameter						Electrical characteristics			
Core factor	Effective magnetic path length	Effective cross-sectional area	Effective core volume	Cross-sectional winding area of core	Weight	AL-value *	Core loss		
C_1 (mm^{-1})	ℓ_e (mm)	A_e (mm^2)	V_e (mm^3)	A_{cw} (mm^2)	(g/set)	(nH/N^2) 1kHz 0.5mA	(W)max. 100kHz 200mT 25°C	80°C	120°C
0.826	13.7	16.5	226	6.39	1.3	2400±25%	0.16	0.15	0.16

NI limit vs. AL-value (Typ.)

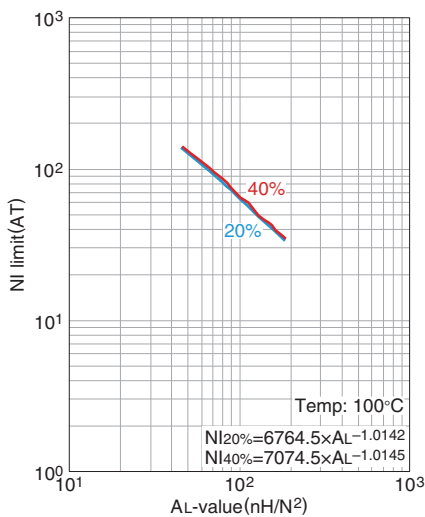

The 20% and 40% graph shows when a 20% and 40% drop from the initial AL-value has been made due to the DC superimposition.

AL-value vs. Air gap length (Typ.)

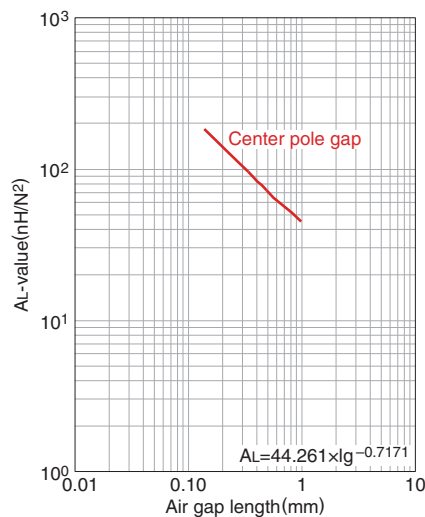

Measuring conditions

- Coil : $\phi 0.18$ 2UEW 100Ts
- Frequency : 1kHz
- Current level : 0.5mA
- Ambient temperature : 25°C

Mn-Zn Planar series Part No.: PC90ELT13X3.4-Z

SHAPES AND DIMENSIONS

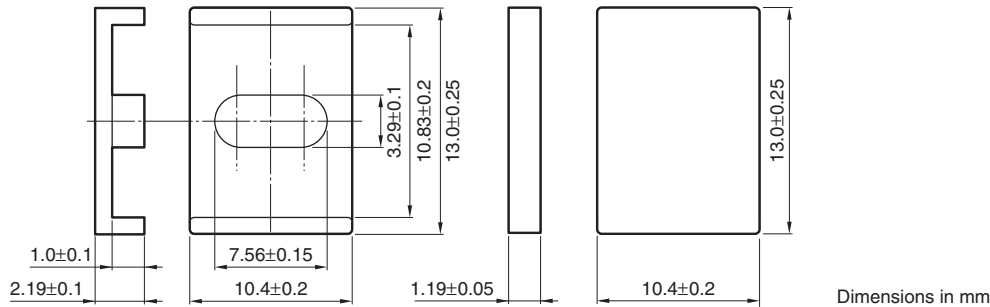

Effective parameter						Electrical characteristics	
Core factor	Effective magnetic path length	Effective cross-sectional area	Effective core volume	Cross-sectional winding area of core	Weight	AL-value *	Core loss
C_1 (mm ⁻¹)	ℓ_e (mm)	A_e (mm ²)	V_e (mm ³)	A_{cw} (mm ²)	(g/set)	(nH/N ²) 1kHz 0.5mA	(W)max. 100kHz 200mT 100°C
0.578	13.4	23.2	312	3.77	1.8	2400±25%	0.3

NI limit vs. AL-value (Typ.)

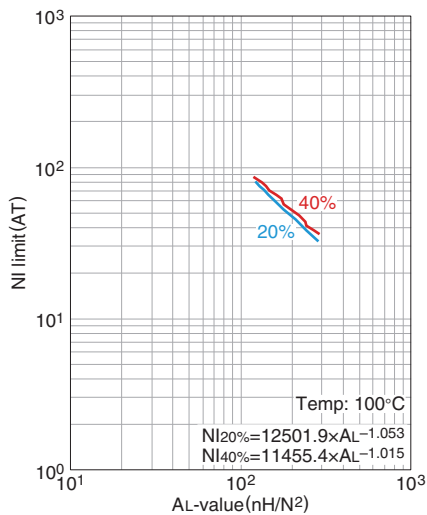

The 20% and 40% graph shows when a 20% and 40% drop from the initial AL-value has been made due to the DC superimposition.

AL-value vs. Air gap length (Typ.)

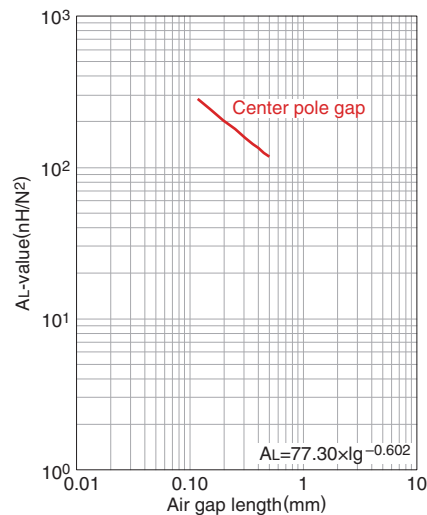

Measuring conditions

- Coil : $\phi 0.18$ 2UEW 100Ts
- Frequency : 1kHz
- Current level : 0.5mA
- Ambient temperature : 25°C

Mn-Zn Planar series Part No.: PC95ELT13X3.4-Z

SHAPES AND DIMENSIONS

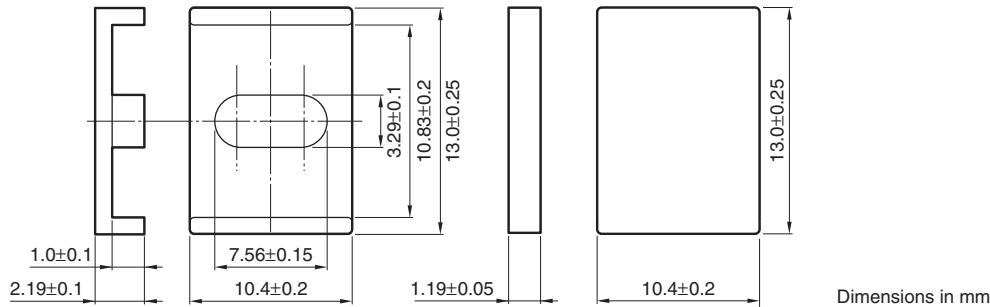

Effective parameter						Electrical characteristics			
Core factor	Effective magnetic path length	Effective cross-sectional area	Effective core volume	Cross-sectional winding area of core	Weight	AL-value *	Core loss		
C_1 (mm ⁻¹)	ℓ_e (mm)	A_e (mm ²)	V_e (mm ³)	A_{cw} (mm ²)	(g/set)	(nH/N ²) 1kHz 0.5mA	(W)max. 100kHz 200mT 25°C	80°C	120°C
0.578	13.4	23.2	312	3.77	1.8	3390±25%	0.3	0.28	0.3

NI limit vs. AL-value (Typ.)

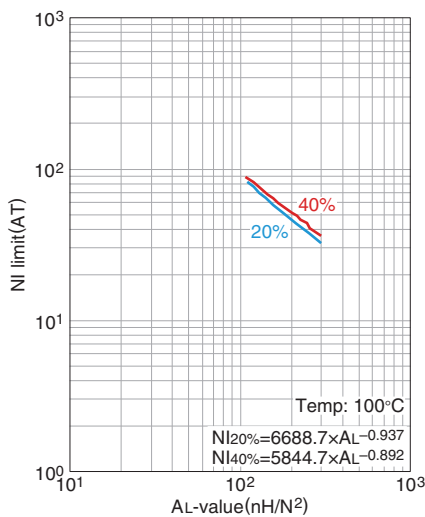

The 20% and 40% graph shows when a 20% and 40% drop from the initial AL-value has been made due to the DC superimposition.

AL-value vs. Air gap length (Typ.)

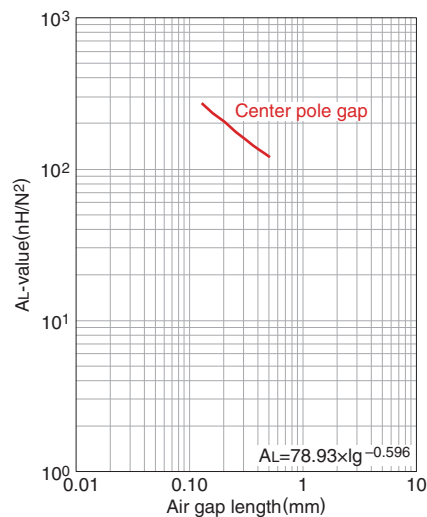

Measuring conditions

- Coil : $\phi 0.18$ 2UEW 100Ts
- Frequency : 1kHz
- Current level : 0.5mA
- Ambient temperature : 25°C

Mn-Zn Planar series Part No.: PC90ELT13X4.4-Z

SHAPES AND DIMENSIONS

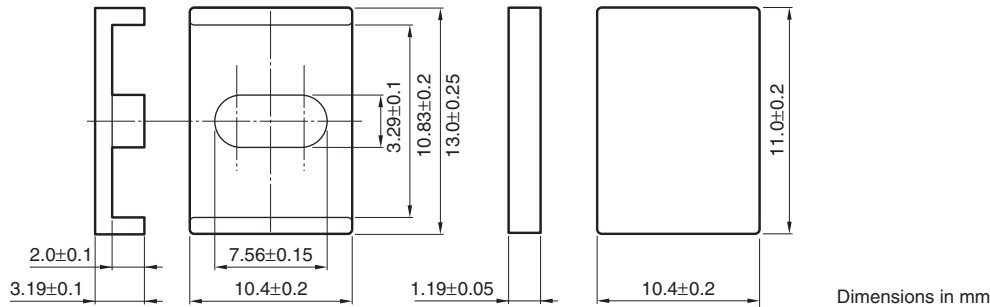

Effective parameter						Electrical characteristics	
Core factor	Effective magnetic path length	Effective cross-sectional area	Effective core volume	Cross-sectional winding area of core	Weight	AL-value *	Core loss
C_1 (mm^{-1})	ℓ_e (mm)	A_e (mm^2)	V_e (mm^3)	A_{cw} (mm^2)	(g/set)	(nH/N^2) 1kHz 0.5mA	(W)max. 100kHz 200mT 100°C
0.667	15.4	23.1	357	7.54	2.0	2300±25%	0.3

NI limit vs. AL-value (Typ.)

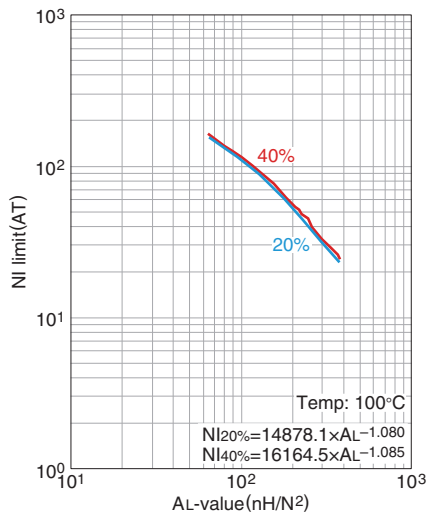

The 20% and 40% graph shows when a 20% and 40% drop from the initial AL-value has been made due to the DC superimposition.

AL-value vs. Air gap length (Typ.)

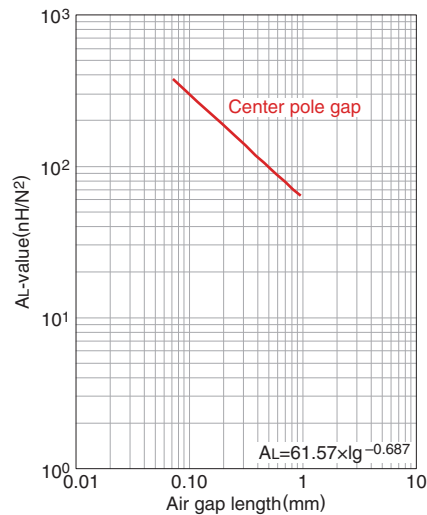

Measuring conditions

- Coil : $\phi 0.18$ 2UEW 100Ts
- Frequency : 1kHz
- Current level : 0.5mA
- Ambient temperature : 25°C

Mn-Zn Planar series Part No.: PC95ELT13X4.4-Z

SHAPES AND DIMENSIONS

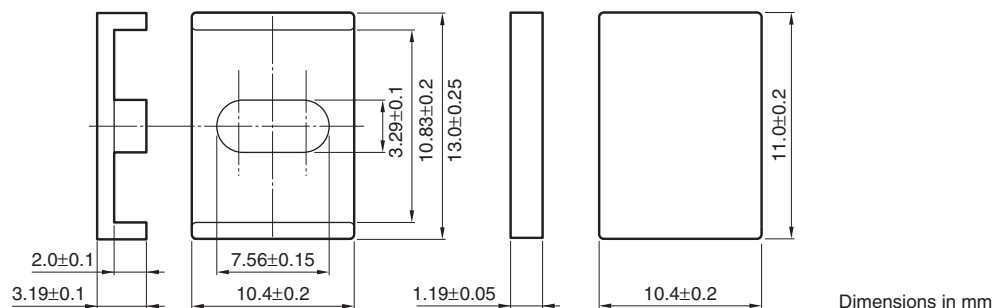

Effective parameter						Electrical characteristics			
Core factor	Effective magnetic path length	Effective cross-sectional area	Effective core volume	Cross-sectional winding area of core	Weight	AL-value *	Core loss		
C_1 (mm ⁻¹)	ℓ_e (mm)	A_e (mm ²)	V_e (mm ³)	A_{cw} (mm ²)	(g/set)	(nH/N ²) 1kHz 0.5mA	(W)max. 100kHz 200mT 25°C	80°C	120°C
0.667	15.4	23.1	357	7.54	2.0	3160±25%	0.3	0.28	0.3

NI limit vs. AL-value (Typ.)

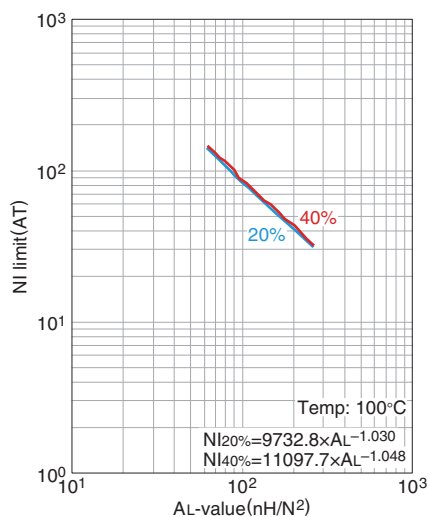

The 20% and 40% graph shows when a 20% and 40% drop from the initial AL-value has been made due to the DC superimposition.

AL-value vs. Air gap length (Typ.)

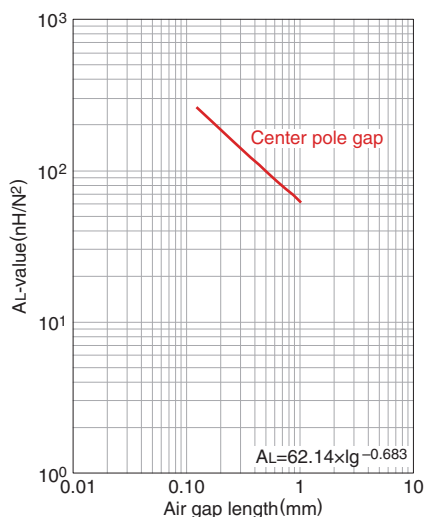

Measuring conditions

- Coil : $\phi 0.18$ 2UEW 100Ts
- Frequency : 1kHz
- Current level : 0.5mA
- Ambient temperature : 25°C

Mn-Zn Planar series Part No.: PC90ELT15.5X4.3-Z

SHAPES AND DIMENSIONS

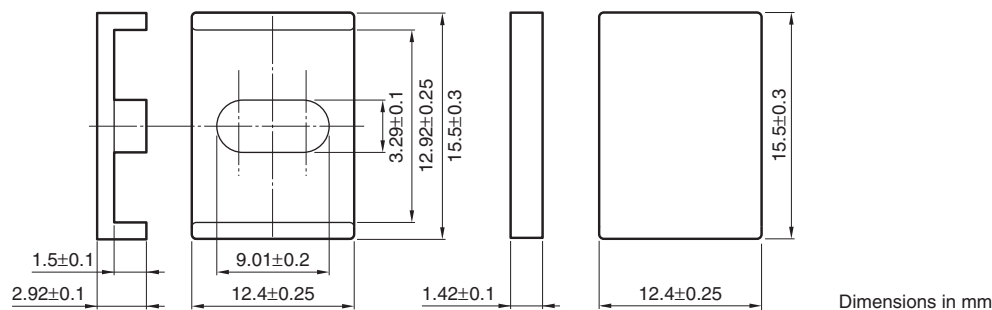

Effective parameter						Electrical characteristics	
Core factor	Effective magnetic path length	Effective cross-sectional area	Effective core volume	Cross-sectional winding area of core	Weight	AL-value *	Core loss
C_1 (mm^{-1})	ℓ_e (mm)	A_e (mm^2)	V_e (mm^3)	A_{cw} (mm^2)	(g/set)	(nH/N^2) 1kHz 0.5mA	(W)max. 100kHz 200mT 100°C
0.503	16.6	33.1	550	6.75	3.0	2900±25%	0.5

NI limit vs. AL-value (Typ.)

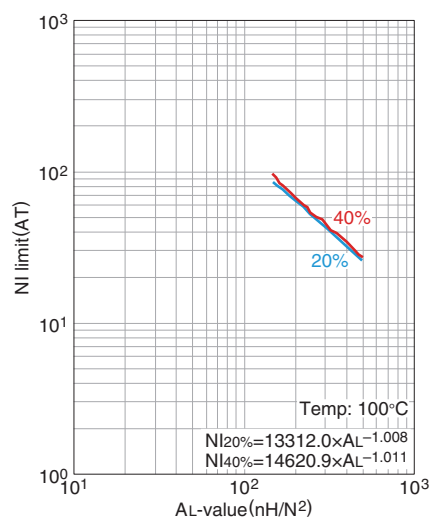

The 20% and 40% graph shows when a 20% and 40% drop from the initial AL-value has been made due to the DC superimposition.

AL-value vs. Air gap length (Typ.)

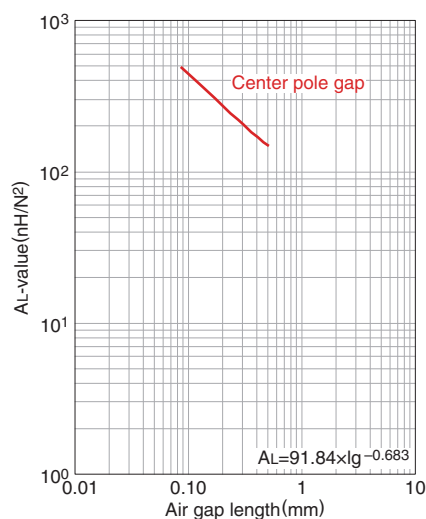

Measuring conditions

- Coil : $\phi 0.18$ 2UEW 100Ts
- Frequency : 1kHz
- Current level : 0.5mA
- Ambient temperature : 25°C

Mn-Zn Planar series Part No.: PC95ELT15.5X4.3-Z

SHAPES AND DIMENSIONS

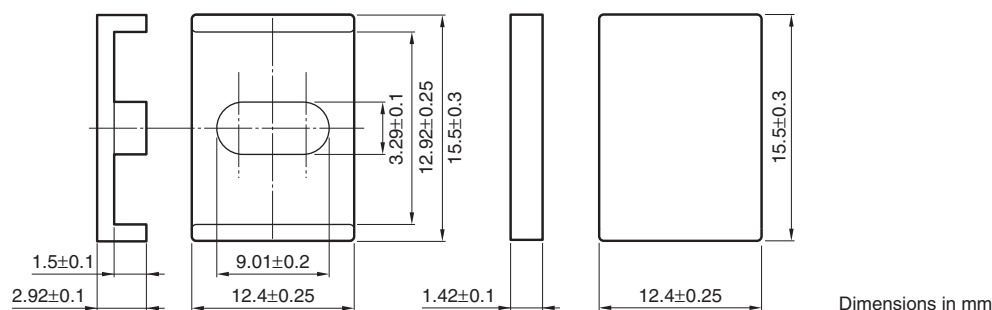

Effective parameter						Electrical characteristics				
Core factor	Effective magnetic path length	Effective cross-sectional area	Effective core volume	Cross-sectional winding area of core	Weight	AL-value *	Core loss			
C_1 (mm ⁻¹)	ℓ_e (mm)	A_e (mm ²)	V_e (mm ³)	A_{cw} (mm ²)	(g/set)	(nH/N ²) 1kHz 0.5mA	(W)max. 100kHz 200mT	25°C	80°C	120°C
0.503	16.6	33.1	550	6.75	3.0	4340±25%	0.5	0.45	0.5	

NI limit vs. AL-value (Typ.)

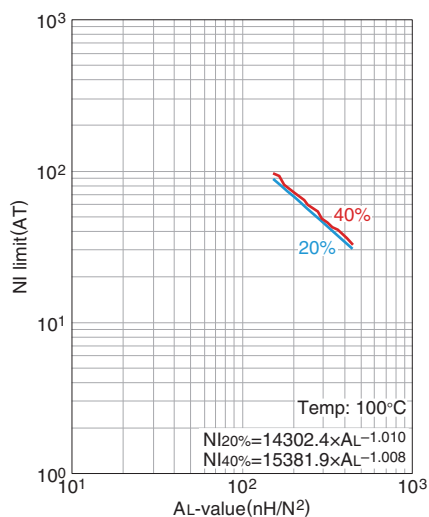

The 20% and 40% graph shows when a 20% and 40% drop from the initial AL-value has been made due to the DC superimposition.

AL-value vs. Air gap length (Typ.)

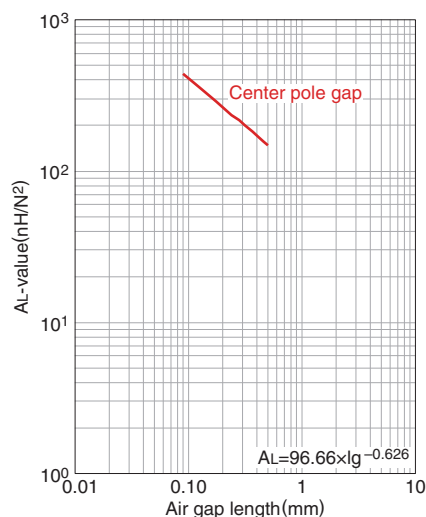

Measuring conditions

- Coil : $\phi 0.18$ 2UEW 100Ts
- Frequency : 1kHz
- Current level : 0.5mA
- Ambient temperature : 25°C

Mn-Zn Planar series Part No.: PC90ELT18X7.3-Z

■ SHAPES AND DIMENSIONS

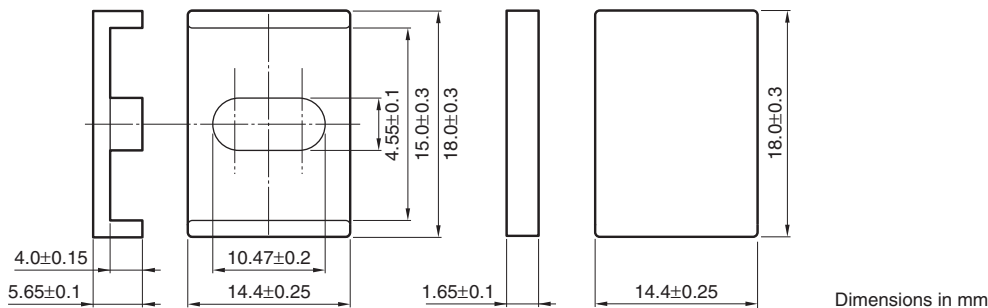

Effective parameter						Electrical characteristics	
Core factor	Effective magnetic path length	Effective cross-sectional area	Effective core volume	Cross-sectional winding area of core	Weigh	AL-value *	Core loss
C ₁ (mm ⁻¹)	ℓ _e (mm)	A _e (mm ²)	V _e (mm ³)	A _{cw} (mm ²)	(g/set)	(nH/N ²) 1kHz 0.5mA	(W)max. 100kHz 200mT 100°C
0.538	23.8	44.3	1050	20.9	6.0	3100±25%	0.7

NI limit vs. AL-value (Typ.)

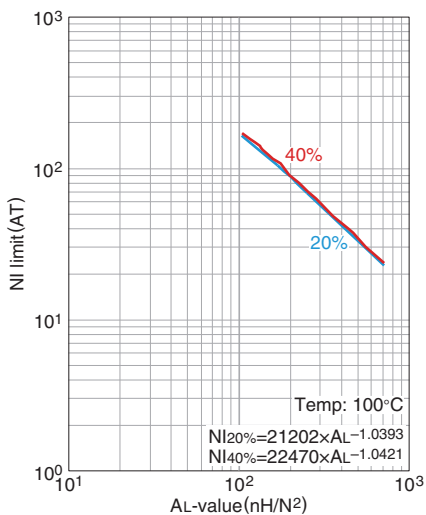

The 20% and 40% graph shows when a 20% and 40% drop from the initial AL-value has been made due to the DC superimposition.

AL-value vs. Air gap length (Typ.)

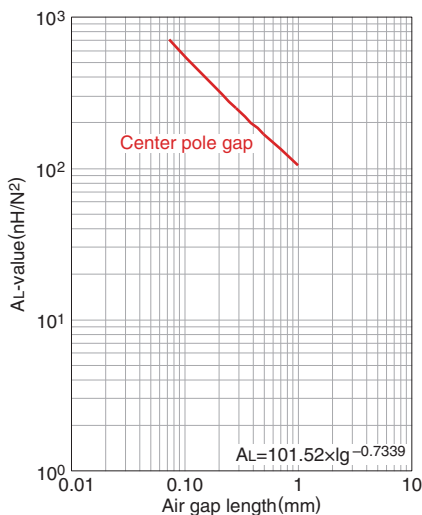

- Measuring conditions
- Coil : ø0.18 2UEW 100Ts
 - Frequency : 1kHz
 - Current level : 0.5mA
 - Ambient temperature : 25°C

⚠ Please be sure to request delivery specifications that provide further details on the features and specifications of the products for proper and safe use. Please note that the contents may change without any prior notice due to reasons such as upgrading.

Mn-Zn Planar series Part No.: PC95ELT18X7.3-Z

SHAPES AND DIMENSIONS

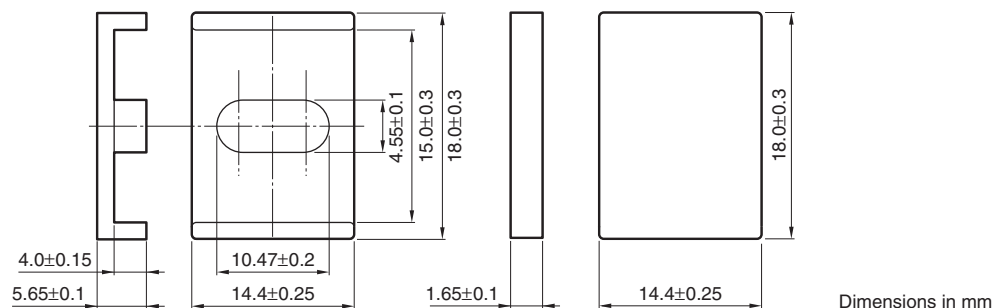

Effective parameter						Electrical characteristics			
Core factor	Effective magnetic path length	Effective cross-sectional area	Effective core volume	Cross-sectional winding area of core	Weight	AL-value *	Core loss		
C_1 (mm^{-1})	ℓ_e (mm)	A_e (mm^2)	V_e (mm^3)	A_{cw} (mm^2)	(g/set)	(nH/N^2) 1kHz 0.5mA	(W)max. 100kHz 200mT 25°C	80°C	120°C
0.538	23.8	44.3	1050	20.9	6.0	4760±25%	0.6	0.55	0.6

NI limit vs. AL-value (Typ.)

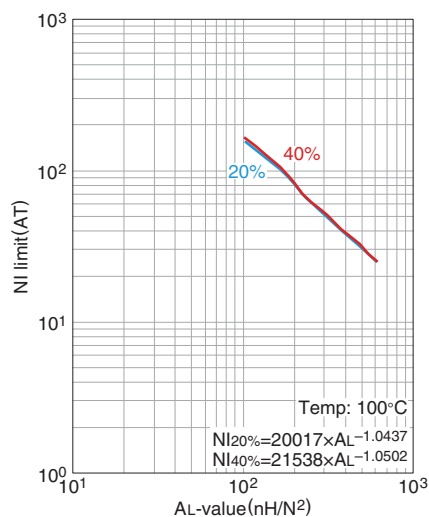

The 20% and 40% graph shows when a 20% and 40% drop from the initial AL-value has been made due to the DC superimposition.

AL-value vs. Air gap length (Typ.)

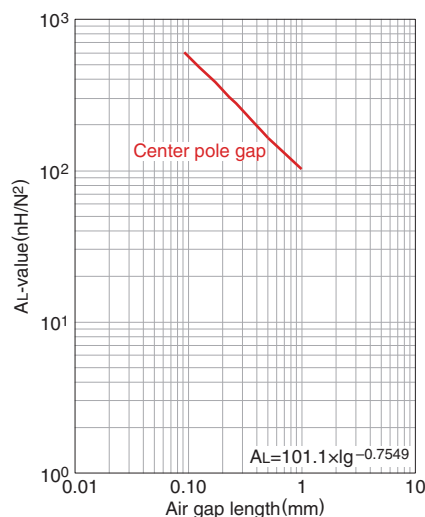

Measuring conditions

- Coil : $\phi 0.18$ 2UEW 100Ts
- Frequency : 1kHz
- Current level : 0.5mA
- Ambient temperature : 25°C

Mn-Zn Planar series Part No.: PC90ELT25X8.6-Z

SHAPES AND DIMENSIONS

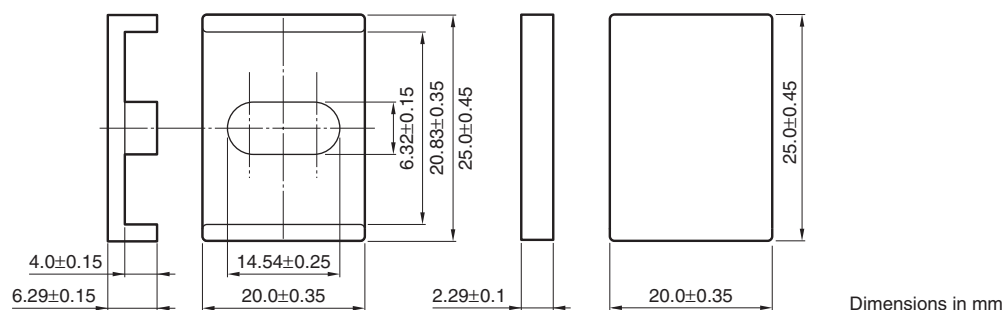

Effective parameter						Electrical characteristics	
Core factor	Effective magnetic path length	Effective cross-sectional area	Effective core volume	Cross-sectional winding area of core	Weigh	AL-value *	Core loss
C_1 (mm^{-1})	ℓ_e (mm)	A_e (mm^2)	V_e (mm^3)	A_{cw} (mm^2)	(g/set)	(nH/N^2) 1kHz 0.5mA	(W)max. 100kHz 200mT 100°C
0.350	30.0	85.6	2570	29.0	15	5400±25%	1.8

NI limit vs. AL-value (Typ.)

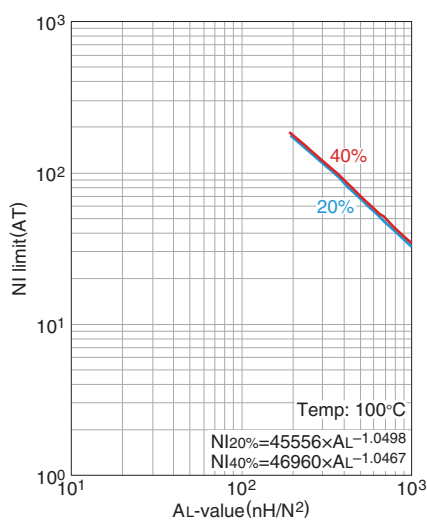

The 20% and 40% graph shows when a 20% and 40% drop from the initial AL-value has been made due to the DC superimposition.

AL-value vs. Air gap length (Typ.)

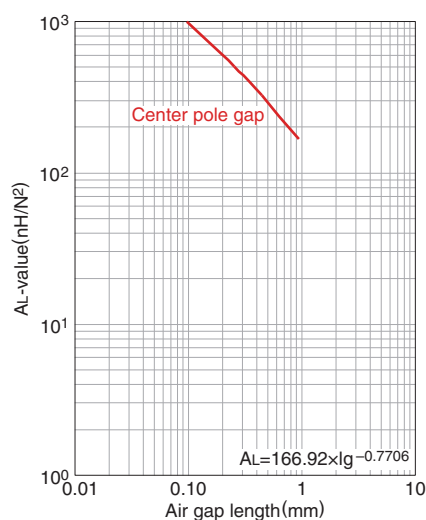

Measuring conditions

- Coil : $\phi 0.18$ 2UEW 100Ts
- Frequency : 1kHz
- Current level : 0.5mA
- Ambient temperature : 25°C

Mn-Zn Planar series Part No.: PC95ELT25X8.6-Z

■ SHAPES AND DIMENSIONS

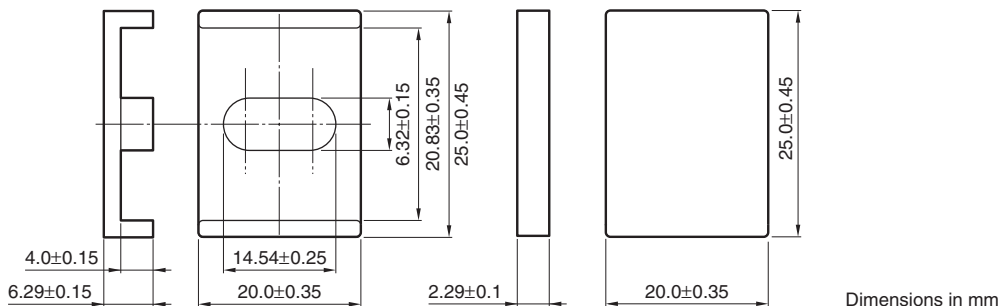

Effective parameter						Electrical characteristics			
Core factor	Effective magnetic path length	Effective cross-sectional area	Effective core volume	Cross-sectional winding area of core	Weight	AL-value *	Core loss		
C_1 (mm ⁻¹)	ℓ_e (mm)	A_e (mm ²)	V_e (mm ³)	A_{cw} (mm ²)	(g/set)	(nH/N ²) 1kHz 0.5mA	(W)max. 100kHz 200mT 25°C	80°C	120°C
0.350	30.0	85.6	2570	29.0	15	7540±25%	1.6	1.5	1.6

NI limit vs. AL-value (Typ.)

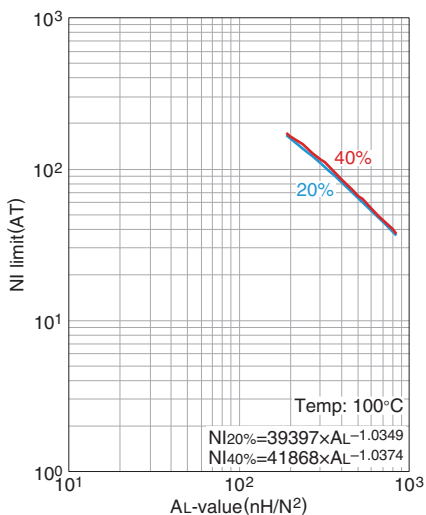

The 20% and 40% graph shows when a 20% and 40% drop from the initial AL-value has been made due to the DC superimposition.

AL-value vs. Air gap length (Typ.)

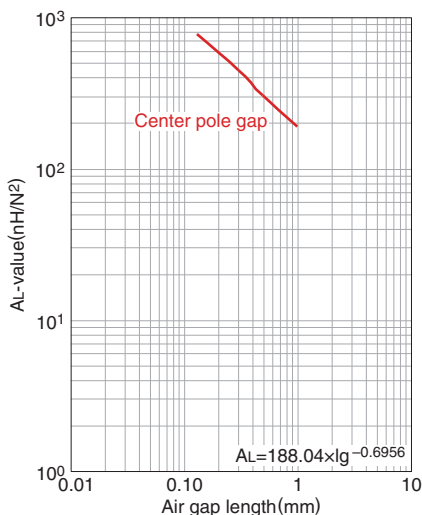

Measuring conditions
 • Coil : ø0.18 2UEW 100Ts
 • Frequency : 1kHz
 • Current level : 0.5mA
 • Ambient temperature : 25°C

⚠ Please be sure to request delivery specifications that provide further details on the features and specifications of the products for proper and safe use. Please note that the contents may change without any prior notice due to reasons such as upgrading.

Mn-Zn PQI Cores

SHAPES AND DIMENSIONS

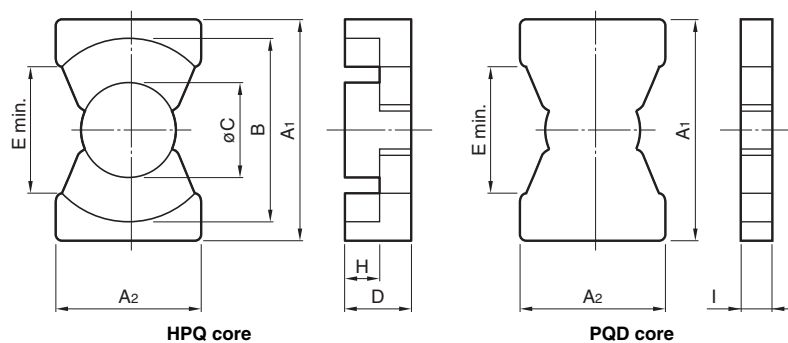
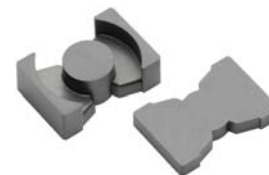

PC95	PQI16/7.8Z	-	12
Material	Size of E core		AL-value (Z: without air gap)

Part No.(HPQ+PQD)	Dimensions (mm)							
	A1	A2	B	øC	D	E min.	H	I
PC95PQI16/7.8Z-12	16.40±0.30	11.20±0.30	14.40±0.30	7.00±0.20	5.40±0.10	9.60	3.05±0.15	2.35±0.10
PC90PQI16/7.8Z-12								
PC95PQI20/9Z-12	20.50±0.40	14.00±0.40	18.00±0.40	8.80±0.20	6.00±0.10	12.00	3.05±0.15	2.95±0.10
PC90PQI20/9Z-12								
PC95PQI26/12Z-12	26.50±0.45	19.00±0.45	22.50±0.45	12.00±0.20	7.30±0.10	15.50	3.10±0.15	4.20±0.10
PC90PQI26/12Z-12								

Part No.(ELH+ELH)	Effective parameter							Electrical characteristics	
	Core factor $C_1(\text{mm}^{-1})$	Effective magnetic path length $\ell_e(\text{mm})$	Effective cross-sectional area $A_e(\text{mm}^2)$	Effective core volume $V_e(\text{mm}^3)$	$A_{\text{min.}}$ (mm^2)	A_{cw} (mm^2)	Weigh (g)	AL-value	
PC95PQI16/7.8Z-12	0.467	19.5	41.8	815	37.6	11.3	5.0	4910±25%	63±3%
PC90PQI16/7.8Z-12								3600±25%	100±5%
PC95PQI20/9Z-12	0.346	22.9	66.0	1510	59.3	14.0	9.0	7070±25%	100±3%
PC90PQI20/9Z-12								5200±25%	160±5%
PC95PQI26/12Z-12	0.224	27.7	123	3410	109	16.3	21	11950±25%	100±3%
PC90PQI26/12Z-12								8600±25%	160±3%

⚠ Please be sure to request delivery specifications that provide further details on the features and specifications of the products for proper and safe use.
Please note that the contents may change without any prior notice due to reasons such as upgrading.

Mn-Zn Planar series Part No.: PC90PQI16/7.8Z-12

■ SHAPES AND DIMENSIONS

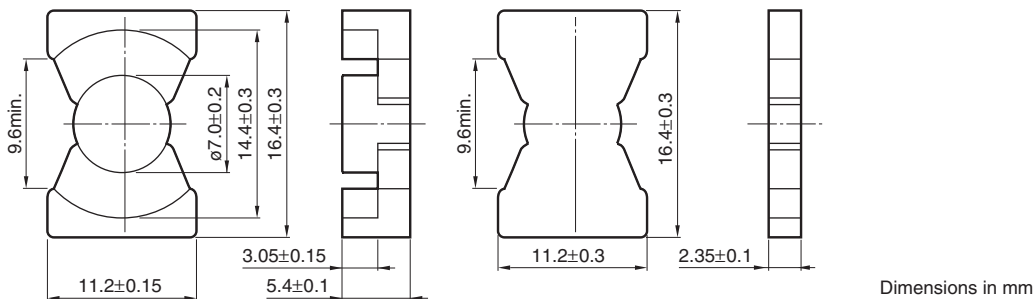

Effective parameter						Electrical characteristics	
Core factor	Effective magnetic path length	Effective cross-sectional area	Effective core volume	Cross-sectional winding area of core	Weigh	AL-value *	Core loss
C ₁ (mm ⁻¹)	ℓ _e (mm)	A _e (mm ²)	V _e (mm ³)	A _{cw} (mm ²)	(g/set)	(nH/N ²) 1kHz 0.5mA	(W)max. 100kHz 200mT 100°C
0.467	19.5	41.8	815	11.3	5.0	3600±25%	0.5

NI limit vs. AL-value (Typ.)

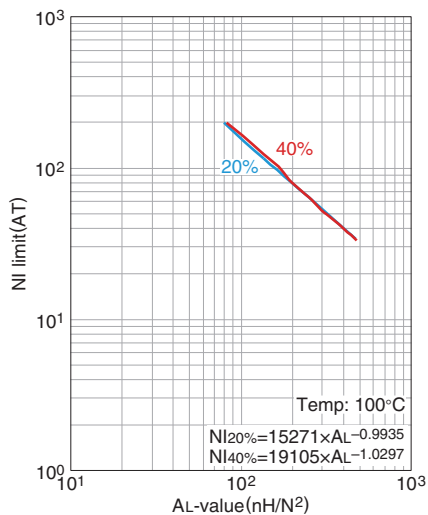

The 20% and 40% graph shows when a 20% and 40% drop from the initial AL-value has been made due to the DC superimposition.

AL-value vs. Air gap length (Typ.)

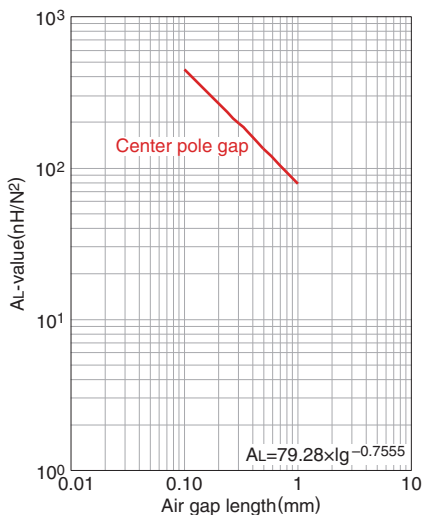

- Measuring conditions
- Coil : ø0.18 2UEW 100Ts
 - Frequency : 1kHz
 - Current level : 0.5mA
 - Ambient temperature : 25°C

⚠ Please be sure to request delivery specifications that provide further details on the features and specifications of the products for proper and safe use. Please note that the contents may change without any prior notice due to reasons such as upgrading.

Mn-Zn Planar series Part No.: PC95PQI16/7.8Z-12

SHAPES AND DIMENSIONS

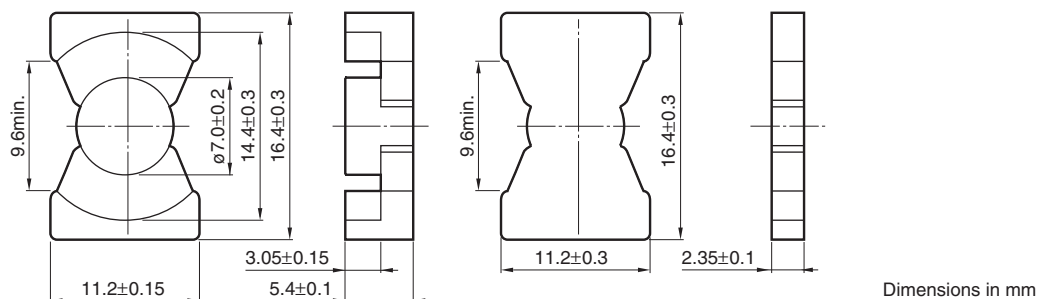

Dimensions in mm

Effective parameter						Electrical characteristics				
Core factor	Effective magnetic path length	Effective cross-sectional area	Effective core volume	Cross-sectional winding area of core	Weight	AL-value *	Core loss			
C_1 (mm ⁻¹)	ℓ_e (mm)	A_e (mm ²)	V_e (mm ³)	A_{cw} (mm ²)	(g/set)	(nH/N ²) 1kHz 0.5mA	(W)max. 100kHz 200mT	25°C	80°C	120°C
0.467	19.5	41.8	815	11.3	5.0	4910±25%	0.45	0.35	0.45	

NI limit vs. AL-value (Typ.)

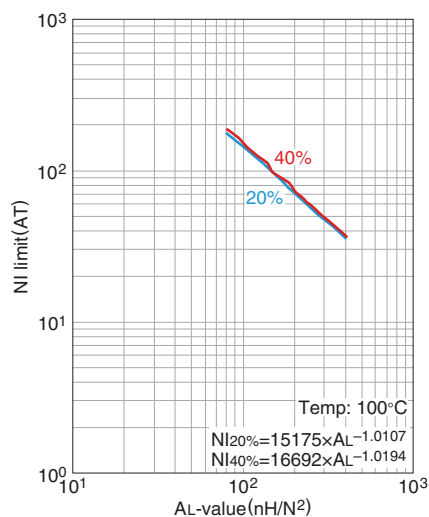

The 20% and 40% graph shows when a 20% and 40% drop from the initial AL-value has been made due to the DC superimposition.

AL-value vs. Air gap length (Typ.)

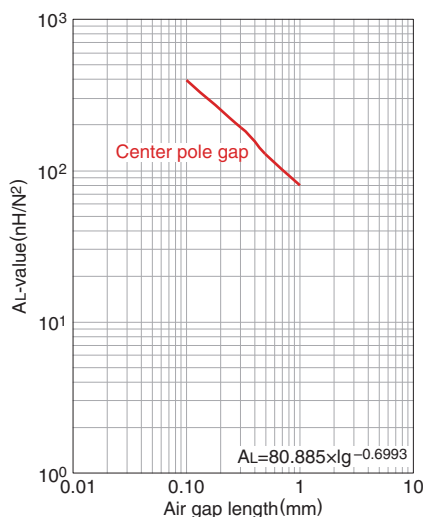

Measuring conditions

- Coil : $\phi 0.18$ 2UEW 100Ts
- Frequency : 1kHz
- Current level : 0.5mA
- Ambient temperature : 25°C

Mn-Zn Planar series Part No.: PC90PQI20/9Z-12

SHAPES AND DIMENSIONS

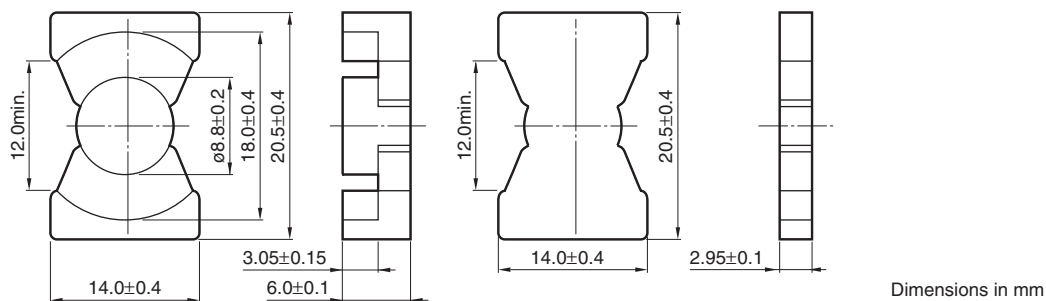

Dimensions in mm

Effective parameter						Electrical characteristics	
Core factor	Effective magnetic path length	Effective cross-sectional area	Effective core volume	Cross-sectional winding area of core	Weight	AL-value *	Core loss
C ₁ (mm ⁻¹)	ℓ _e (mm)	A _e (mm ²)	V _e (mm ³)	A _{cw} (mm ²)	(g/set)	(nH/N ²) 1kHz 0.5mA	(W)max. 100kHz 200mT 100°C
0.346	22.9	66.0	1510	14.0	9.0	5200±25%	0.8

NI limit vs. AL-value (Typ.)

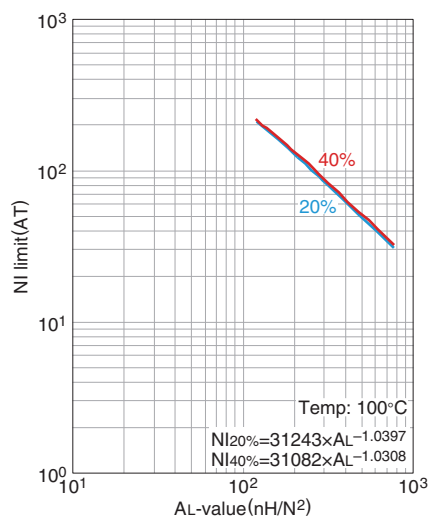

The 20% and 40% graph shows when a 20% and 40% drop from the initial AL-value has been made due to the DC superimposition.

AL-value vs. Air gap length (Typ.)

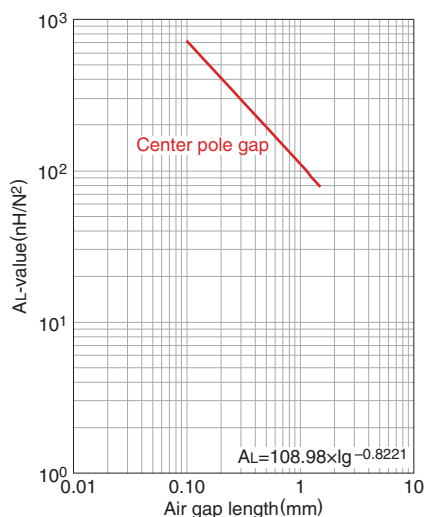

Measuring conditions
 • Coil : ø0.18 2UEW 100Ts
 • Frequency : 1kHz
 • Current level : 0.5mA
 • Ambient temperature : 25°C

⚠ Please be sure to request delivery specifications that provide further details on the features and specifications of the products for proper and safe use. Please note that the contents may change without any prior notice due to reasons such as upgrading.

Mn-Zn Planar series Part No.: PC95PQI20/9Z-12

■ SHAPES AND DIMENSIONS

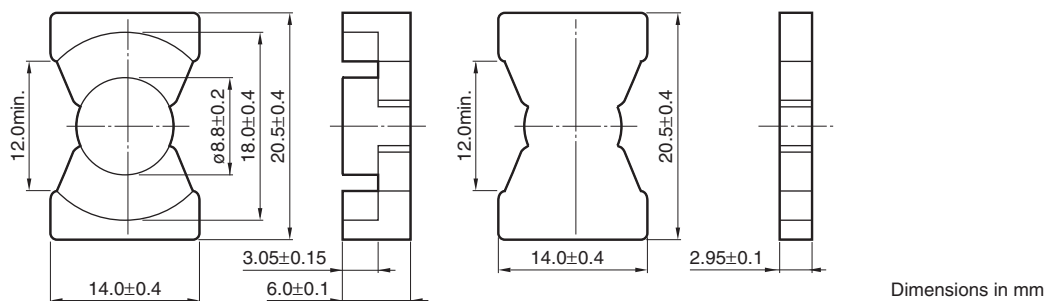

Effective parameter						Electrical characteristics				
Core factor	Effective magnetic path length	Effective cross-sectional area	Effective core volume	Cross-sectional winding area of core	Weight	AL-value *	Core loss			
C ₁ (mm ⁻¹)	ℓ _e (mm)	A _e (mm ²)	V _e (mm ³)	A _{cw} (mm ²)	(g/set)	(nH/N ²) 1kHz 0.5mA	(W)max. 100kHz 200mT	25°C	80°C	120°C
0.346	22.9	66.0	1510	14.0	9.0	7070±25%	0.75	0.65	0.75	

NI limit vs. AL-value (Typ.)

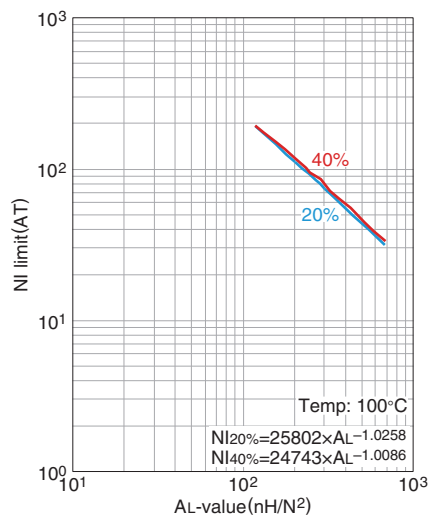

The 20% and 40% graph shows when a 20% and 40% drop from the initial AL-value has been made due to the DC superimposition.

AL-value vs. Air gap length (Typ.)

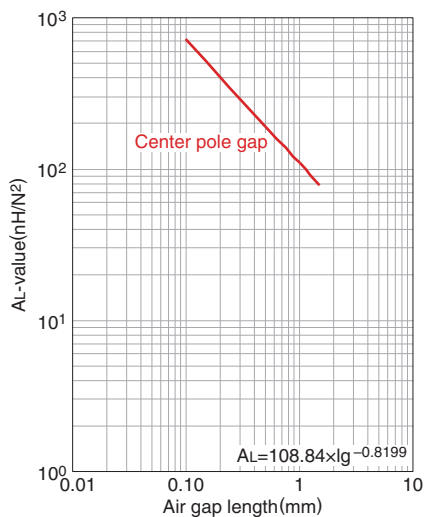

Measuring conditions

- Coil : ø0.18 2UEW 100Ts
- Frequency : 1kHz
- Current level : 0.5mA
- Ambient temperature : 25°C

⚠ Please be sure to request delivery specifications that provide further details on the features and specifications of the products for proper and safe use. Please note that the contents may change without any prior notice due to reasons such as upgrading.

Mn-Zn Planar series Part No.: PC90PQI26/12Z-12

■ SHAPES AND DIMENSIONS

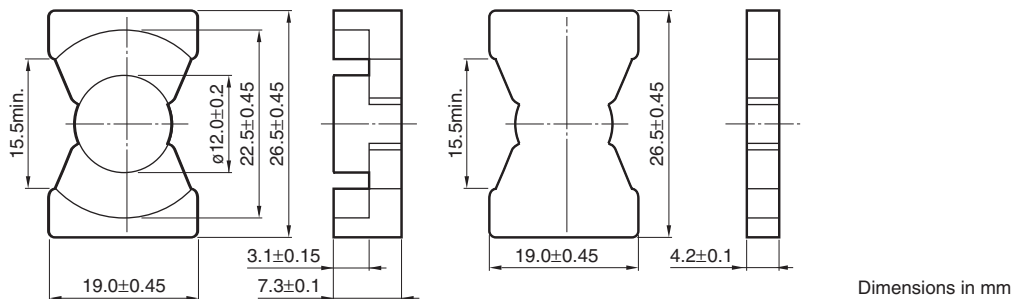

Effective parameter						Electrical characteristics	
Core factor	Effective magnetic path length	Effective cross-sectional area	Effective core volume	Cross-sectional winding area of core	Weight	AL-value *	Core loss
C ₁ (mm ⁻¹)	ℓ _e (mm)	A _e (mm ²)	V _e (mm ³)	A _{cw} (mm ²)	(g/set)	(nH/N ²) 1kHz 0.5mA	(W)max. 100kHz 200mT 100°C
0.224	27.7	123	3410	16.3	21	8600±25%	1.6

NI limit vs. AL-value (Typ.)

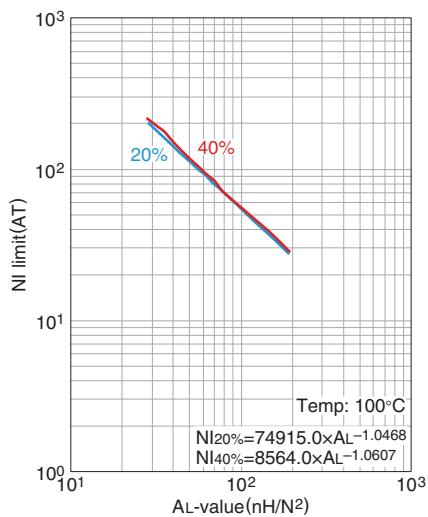

The 20% and 40% graph shows when a 20% and 40% drop from the initial AL-value has been made due to the DC superimposition.

AL-value vs. Air gap length (Typ.)

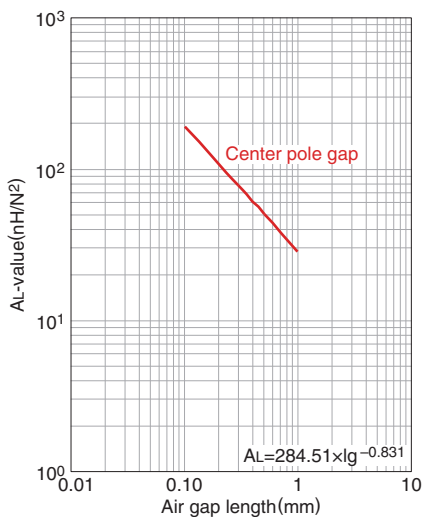

Measuring conditions
 • Coil : ø0.18 2UEW 100Ts
 • Frequency : 1kHz
 • Current level : 0.5mA
 • Ambient temperature : 25°C

⚠ Please be sure to request delivery specifications that provide further details on the features and specifications of the products for proper and safe use. Please note that the contents may change without any prior notice due to reasons such as upgrading.

Mn-Zn Planar series Part No.: PC95PQI26/12Z-12

■ SHAPES AND DIMENSIONS

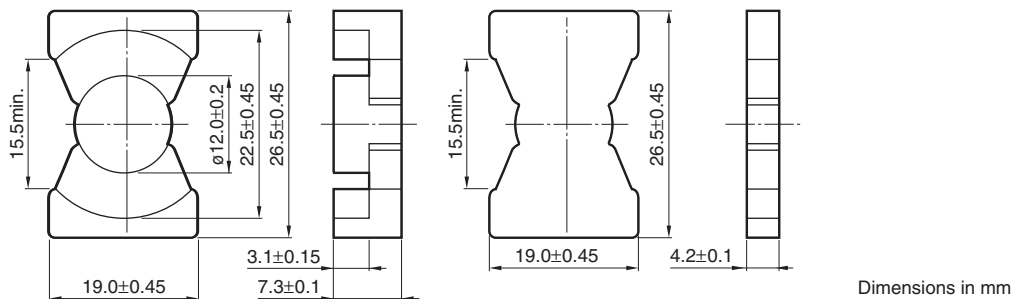

Effective parameter						Electrical characteristics				
Core factor	Effective magnetic path length	Effective cross-sectional area	Effective core volume	Cross-sectional winding area of core	Weight	AL-value *	Core loss			
C ₁ (mm ⁻¹)	ℓ _e (mm)	A _e (mm ²)	V _e (mm ³)	A _{cw} (mm ²)	(g/set)	(nH/N ²) 1kHz 0.5mA	(W)max. 100kHz 200mT	25°C	80°C	120°C
0.224	27.7	123	3410	16.3	21	11950±25%	1.5	1.4	1.5	

NI limit vs. AL-value (Typ.)

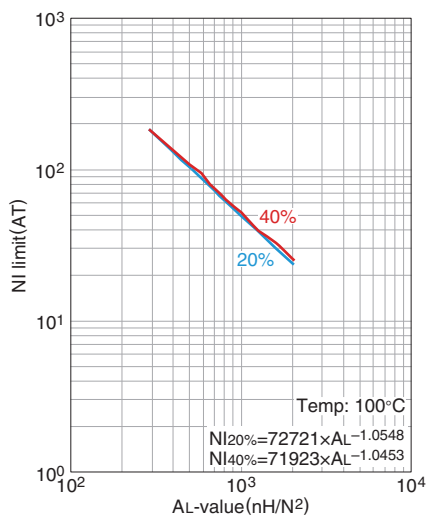

The 20% and 40% graph shows when a 20% and 40% drop from the initial AL-value has been made due to the DC superimposition.

AL-value vs. Air gap length (Typ.)

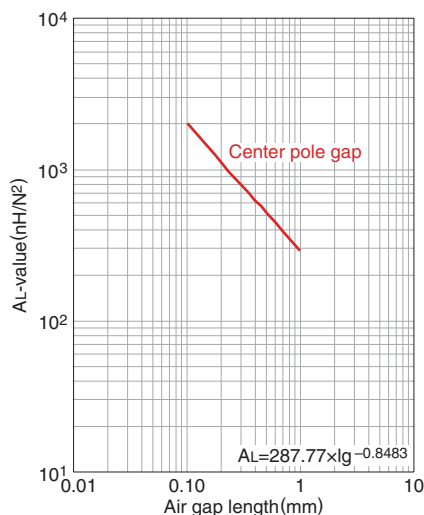

Measuring conditions
 • Coil : ø0.18 2UEW 100Ts
 • Frequency : 1kHz
 • Current level : 0.5mA
 • Ambient temperature : 25°C

⚠ Please be sure to request delivery specifications that provide further details on the features and specifications of the products for proper and safe use. Please note that the contents may change without any prior notice due to reasons such as upgrading.

Mn-Zn EIR Cores

SHAPES AND DIMENSIONS

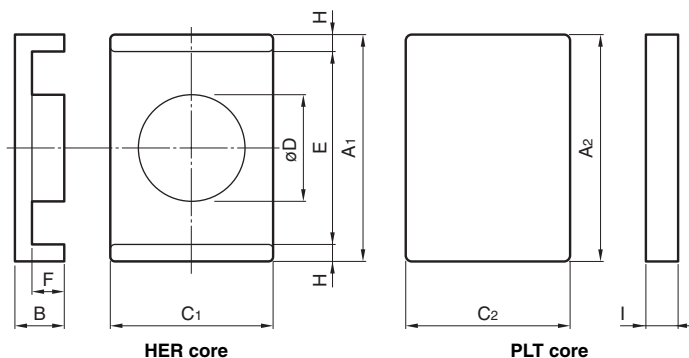
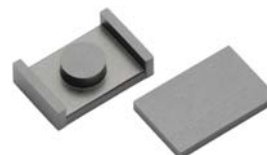

PC95	EIR14/4.5/9	-	Z
Material	Size of E core		AL-value (Z: without air gap)

Part No.(ELH+ELH)	Dimensions (mm)									
	A1	B	C1	øD	E	F	H	A2	C2	I
PC95EIR14/4.5/9-Z	13.85±0.25	3.20±0.10	9.00±0.20	5.20±0.10	11.35±0.15	1.90±0.10	1.25	14.00±0.20	9.20±0.20	1.30±0.10
PC90EIR14/4.5/9-Z										
PC95EIR18/5/12-Z	18.15±0.30	3.50±0.10	12.00±0.20	6.00±0.10	15.75±0.25	2.00±0.10	1.20	18.20±0.25	12.20±0.20	1.50±0.10
PC90EIR18/5/12-Z										
PC95EIR22/5.5/15-Z	22.10±0.35	3.75±0.10	15.25±0.25	6.80±0.10	19.70±0.30	2.00±0.10	1.20	22.20±0.30	15.50±0.20	1.75±0.10
PC90EIR22/5.5/15-Z										

Part No.(HPQ+PQD)	Effective parameter							Electrical characteristics	
	Core factor	Effective magnetic path length ℓ_e (mm)	Effective cross-sectional area A_e (mm ²)	Effective core volume V_e (mm ³)	A_{min} (mm ²)	A_{cw} (mm ²)	Weigh (g)	AL-value	
	C_1 (mm ⁻¹)							(nH/N ²) 1kHz 0.5mA 100Ts	
PC95EIR14/4.5/9-Z	0.679	15.4	22.7	349	21.2	5.84	2.0	2800±25%	63±3%
PC90EIR14/4.5/9-Z								2050±25%	100±5% 160±7%
PC95EIR18/5/12-Z	0.601	19.7	32.8	645	28.3	9.75	3.8	3690±25%	80±3%
PC90EIR18/5/12-Z								2500±25%	125±5% 200±7%
PC95EIR22/5.5/15-Z	0.505	23.2	46.1	1070	36.3	12.9	6.5	4150±25%	80±3%
PC90EIR22/5.5/15-Z								3000±25%	125±5% 200±7%

⚠ Please be sure to request delivery specifications that provide further details on the features and specifications of the products for proper and safe use.
Please note that the contents may change without any prior notice due to reasons such as upgrading.

Mn-Zn Planar series Part No.: PC90EIR14/4.5/9-Z

SHAPES AND DIMENSIONS

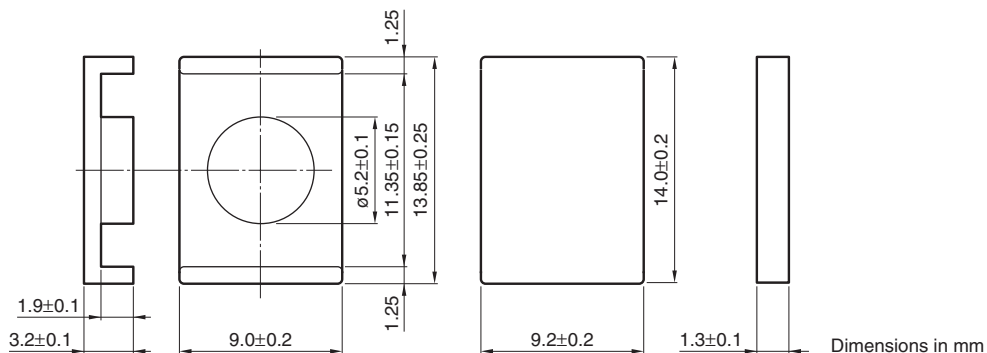

Effective parameter						Electrical characteristics	
Core factor	Effective magnetic path length	Effective cross-sectional area	Effective core volume	Cross-sectional winding area of core	Weigh	AL-value *	Core loss
C ₁ (mm ⁻¹)	ℓ _e (mm)	A _e (mm ²)	V _e (mm ³)	A _{cw} (mm ²)	(g/set)	(nH/N ²) 1kHz 0.5mA	(W)max. 100kHz 200mT 100°C
0.679	15.4	22.7	349	5.84	2.0	2050±25%	0.3

NI limit vs. AL-value (Typ.)

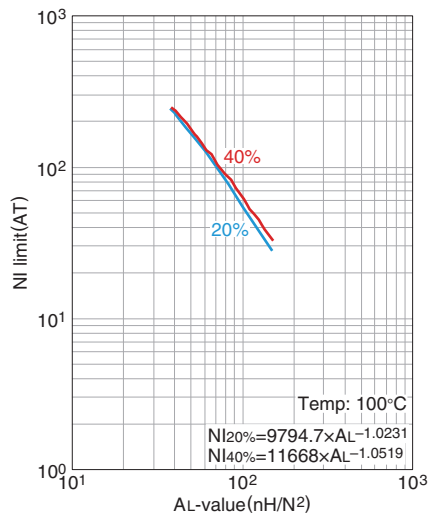

The 20% and 40% graph shows when a 20% and 40% drop from the initial AL-value has been made due to the DC superimposition.

AL-value vs. Air gap length (Typ.)

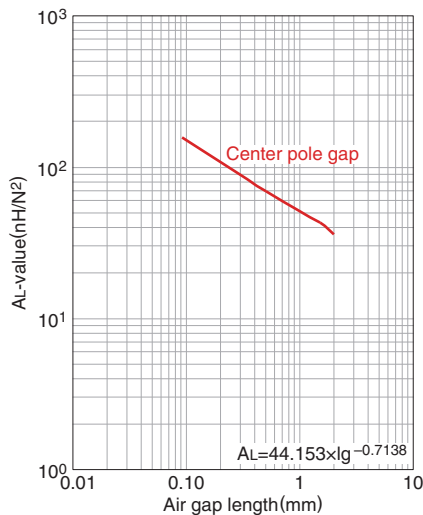

- Measuring conditions
- Coil : ø0.18 2UEW 100Ts
 - Frequency : 1kHz
 - Current level : 0.5mA
 - Ambient temperature : 25°C

 Please be sure to request delivery specifications that provide further details on the features and specifications of the products for proper and safe use. Please note that the contents may change without any prior notice due to reasons such as upgrading.

Mn-Zn Planar series Part No.: PC90EIR18/5/12-Z

SHAPES AND DIMENSIONS

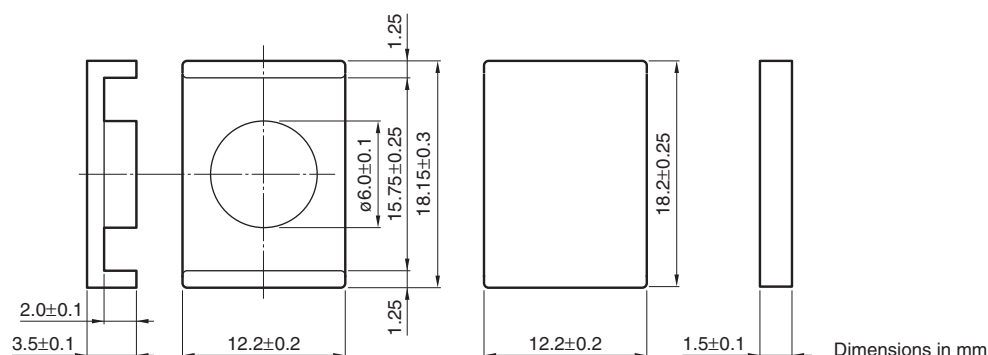

Effective parameter						Electrical characteristics	
Core factor	Effective magnetic path length	Effective cross-sectional area	Effective core volume	Cross-sectional winding area of core	Weight	AL-value *	Core loss
C_1 (mm^{-1})	ℓ_e (mm)	A_e (mm^2)	V_e (mm^3)	A_{cw} (mm^2)	(g/set)	(nH/N^2) 1kHz 0.5mA	(W)max. 100kHz 200mT 100°C
0.601	19.7	32.8	645	9.75	3.8	2500±25%	0.45

NI limit vs. AL-value (Typ.)

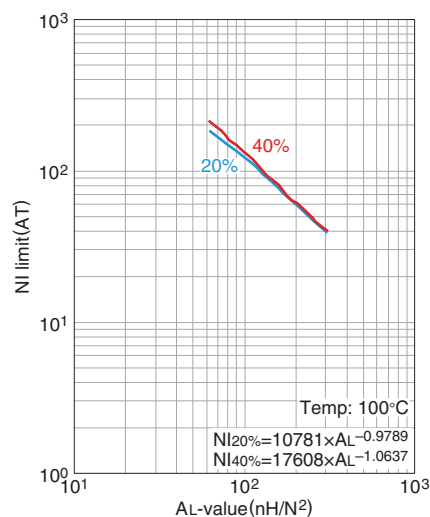

The 20% and 40% graph shows when a 20% and 40% drop from the initial AL-value has been made due to the DC superimposition.

AL-value vs. Air gap length (Typ.)

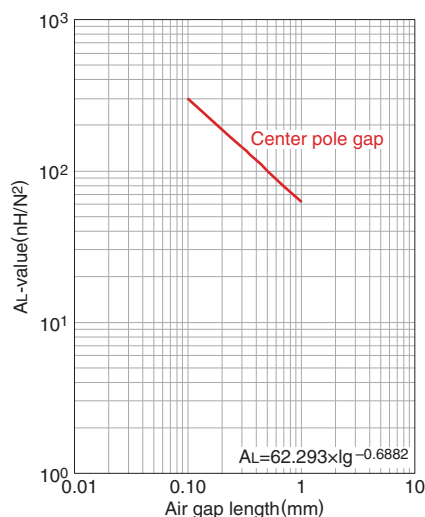

Measuring conditions

- Coil : $\phi 0.18$ 2UEW 100Ts
- Frequency : 1kHz
- Current level : 0.5mA
- Ambient temperature : 25°C

Mn-Zn Planar series Part No.: PC95EIR18/5/12-Z

■ SHAPES AND DIMENSIONS

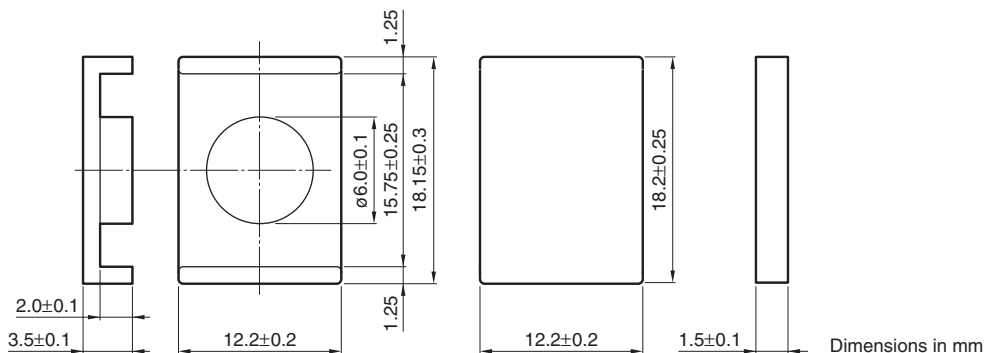

Effective parameter						Electrical characteristics				
Core factor	Effective magnetic path length	Effective cross-sectional area	Effective core volume	Cross-sectional winding area of core	Weight	AL-value *	Core loss			
C ₁ (mm ⁻¹)	ℓ _e (mm)	A _e (mm ²)	V _e (mm ³)	A _{cw} (mm ²)	(g/set)	(nH/N ²) 1kHz 0.5mA	(W)max. 100kHz 200mT	25°C	80°C	120°C
0.601	19.7	32.8	645	9.75	3.8	3690±25%	0.4	0.35	0.4	

NI limit vs. AL-value (Typ.)

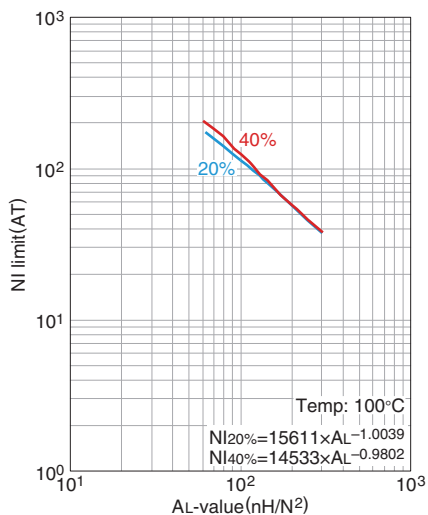

The 20% and 40% graph shows when a 20% and 40% drop from the initial AL-value has been made due to the DC superimposition.

AL-value vs. Air gap length (Typ.)

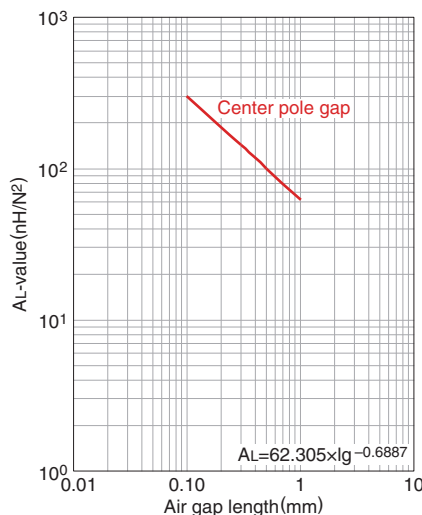

- Measuring conditions
- Coil : ø0.18 2UEW 100Ts
 - Frequency : 1kHz
 - Current level : 0.5mA
 - Ambient temperature : 25°C

 Please be sure to request delivery specifications that provide further details on the features and specifications of the products for proper and safe use. Please note that the contents may change without any prior notice due to reasons such as upgrading.

Mn-Zn ER Cores

SHAPES AND DIMENSIONS

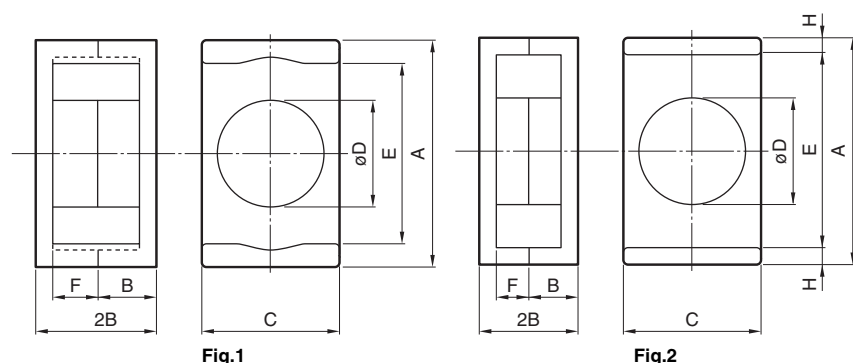

PC95	ER9.5/5	-	Z
Material	Size of E core		AL-value (Z: without air gap)

Part No.(HER+HER)	Core	Dimensions (mm)						
		A	B	C	øD	E	F	H
PC95ER9.5/5-Z	Fig.1	9.5 ⁺⁰ _{-0.3}	2.5 ⁺⁰ _{-0.1}	5.0 ⁺⁰ _{-0.2}	3.5 ⁺⁰ _{-0.2}	7.0min.	1.6 ^{+0.15} ₋₀	—
PC90ER9.5/5-Z								
PC95ER11/5-Z	Fig.1	11.0 ⁺⁰ _{-0.35}	2.5 ⁺⁰ _{-0.1}	6.0 ⁺⁰ _{-0.2}	4.25 ⁺⁰ _{-0.25}	7.9min.	1.5 ^{+0.15} ₋₀	—
PC90ER11/5-Z								
PC95ER14/4.5/9-Z	Fig.2	13.85±0.25	2.25±0.10	9.00±0.20	5.20±0.10	11.35±0.15	0.95±0.10	1.25
PC90ER14/4.5/9-Z								
PC95ER14.5/6-Z	Fig.2	14.5±0.2	3.0 ⁺⁰ _{-0.1}	6.7±0.1	4.7±0.1	11.8±0.2	1.65±0.1	1.35
PC90ER14.5/6-Z								
PC95ER18/5/12-Z	Fig.2	18.15±0.30	2.50±0.10	12.00±0.20	6.00±0.10	15.75±0.25	1.00±0.10	1.20
PC90ER18/5/12-Z								
PC95ER22/5.5/15-Z	Fig.2	22.10±0.35	2.75±0.10	15.25±0.25	6.80±0.10	19.70±0.30	1.00±0.10	1.20
PC90ER22/5.5/15-Z								
PC95ER25/5.5/18-Z	Fig.2	25.30±0.40	2.75±0.10	18.00±0.40	7.00±0.15	22.90±0.40	1.00±0.10	1.20
PC90ER25/5.5/18-Z								

Part No.(HER+HER)	Effective parameter							Electrical characteristics	
	Core factor C ₁ (mm ⁻¹)	Effective magnetic path length ℓ _e (mm)	Effective cross-sectional area A _e (mm ²)	Effective core volume V _e (mm ³)	A _{min} . (mm ²)	A _{cw} (mm ²)	Weigh (g)	AL-value (nH/N ²) 1kHz 0.5mA 100Ts Without air gap With air gap	
PC95ER9.5/5-Z	1.67	14.2	8.47	120	7.6	7.07	0.7	1190±25%	63±5%
PC90ER9.5/5-Z								610min.	100±7%
PC95ER11/5-Z	1.23	14.7	11.9	174	10.3	7.44	1.1	1680±25%	63±5%
PC90ER11/5-Z								1300±25%	100±7%
PC95ER14/4.5/9-Z	0.679	15.4	22.7	349	21.2	5.84	2.0	2550±25%	63±3%
PC90ER14/4.5/9-Z								2100±25%	100±5%
PC95ER14.5/6-Z	1.08	19.0	17.6	333	17.3	8.42	2.0	1880±25%	100±5%
PC90ER14.5/6-Z								1300±25%	160±7%
PC95ER18/5/12-Z	0.601	19.7	32.8	645	28.3	9.75	3.8	3500±25%	80±3%
PC90ER18/5/12-Z								2900±25%	125±5%
PC95ER22/5.5/15-Z	0.505	23.2	46.1	1070	36.3	12.9	6.5	4300±25%	80±3%
PC90ER22/5.5/15-Z								3200±25%	125±5%
PC95ER25/5.5/18-Z	0.486	26.1	53.7	1400	38.5	15.9	8.5	4400±25%	80±3%
PC90ER25/5.5/18-Z								3400±25%	125±3%

⚠ Please be sure to request delivery specifications that provide further details on the features and specifications of the products for proper and safe use.
Please note that the contents may change without any prior notice due to reasons such as upgrading.

Mn-Zn Planar series Part No.: PC90ER9.5/5-Z

SHAPES AND DIMENSIONS

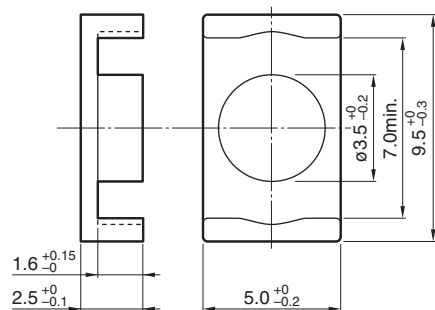

Dimensions in mm

Effective parameter						Electrical characteristics	
Core factor	Effective magnetic path length	Effective cross-sectional area	Effective core volume	Cross-sectional winding area of core	Weigh	AL-value *	Core loss
C ₁ (mm ⁻¹)	ℓ _e (mm)	A _e (mm ²)	V _e (mm ³)	A _{cw} (mm ²)	(g/set)	(nH/N ²) 1kHz 0.5mA	(W)max. 100kHz 200mT 100°C
1.67	14.2	8.47	120	7.07	0.7	610min.	0.1

NI limit vs. AL-value (Typ.)

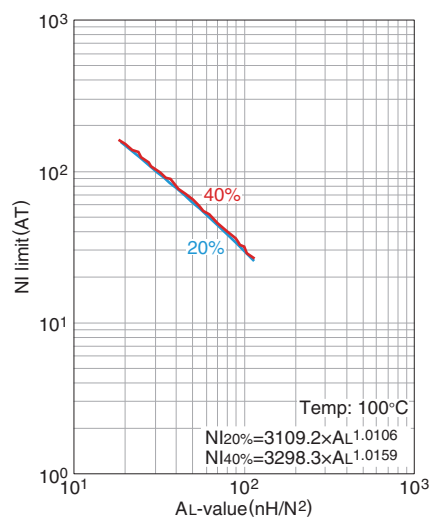

The 20% and 40% graph shows when a 20% and 40% drop from the initial AL-value has been made due to the DC superimposition.

AL-value vs. Air gap length (Typ.)

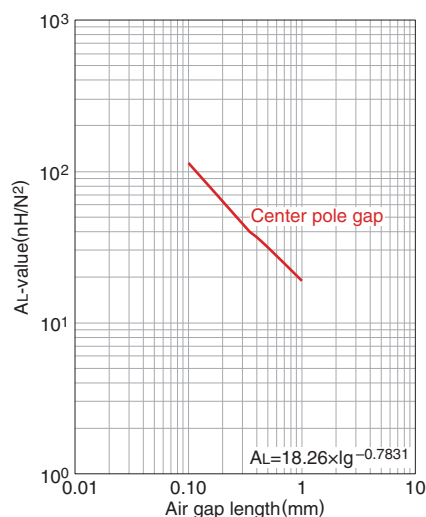

Measuring conditions

- Coil : $\phi 0.18$ 2UEW 100Ts
- Frequency : 1kHz
- Current level : 0.5mA
- Ambient temperature : 25°C

Mn-Zn Planar series Part No.: PC95ER9.5/5-Z

SHAPES AND DIMENSIONS

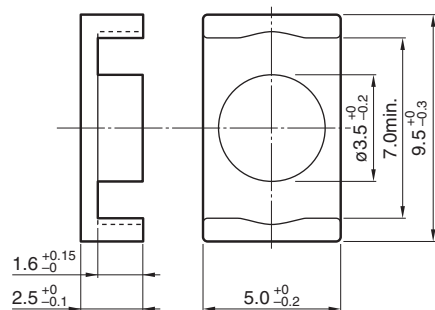

Dimensions in mm

Effective parameter						Electrical characteristics				
Core factor	Effective magnetic path length	Effective cross-sectional area	Effective core volume	Cross-sectional winding area of core	Weight	AL-value *	Core loss			
C ₁ (mm ⁻¹)	ℓ _e (mm)	A _e (mm ²)	V _e (mm ³)	A _{cw} (mm ²)	(g/set)	(nH/N ²) 1kHz 0.5mA	(W)max. 100kHz 200mT	25°C	80°C	120°C
1.67	14.2	8.47	120	7.07	0.7	1190±25%	0.1	0.09	0.1	

NI limit vs. AL-value (Typ.)

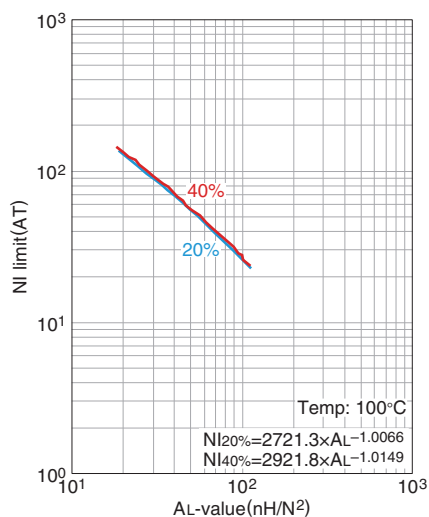

The 20% and 40% graph shows when a 20% and 40% drop from the initial AL-value has been made due to the DC superimposition.

AL-value vs. Air gap length (Typ.)

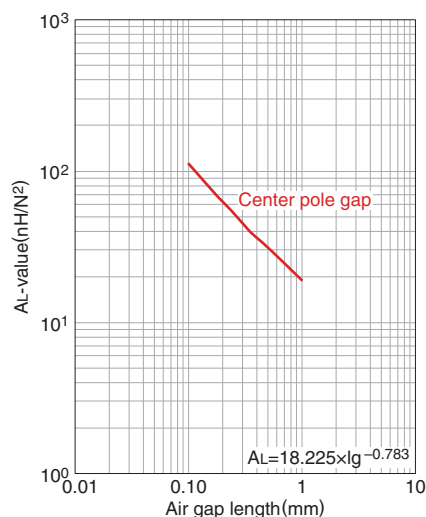

Measuring conditions
 • Coil : ø0.18 2UEW 100Ts
 • Frequency : 1kHz
 • Current level : 0.5mA
 • Ambient temperature : 25°C

⚠ Please be sure to request delivery specifications that provide further details on the features and specifications of the products for proper and safe use. Please note that the contents may change without any prior notice due to reasons such as upgrading.

Mn-Zn Planar series **Part No.: PC90ER14/4.5/9-Z**

■ SHAPES AND DIMENSIONS

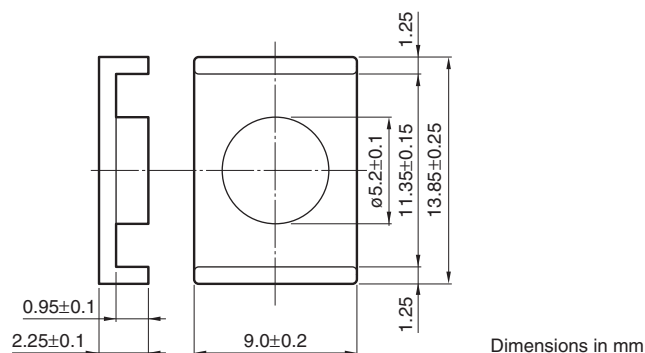

Effective parameter						Electrical characteristics	
Core factor	Effective magnetic path length	Effective cross-sectional area	Effective core volume	Cross-sectional winding area of core	Weight	AL-value *	Core loss
C_1 (mm^{-1})	ℓ_e (mm)	A_e (mm^2)	V_e (mm^3)	A_{cw} (mm^2)	(g/set)	(nH/N^2) 1kHz 0.5mA	(W)max. 100kHz 200mT 100°C
0.679	15.4	22.7	349	5.84	2.0	2100±25%	0.3

NI limit vs. AL-value (Typ.)

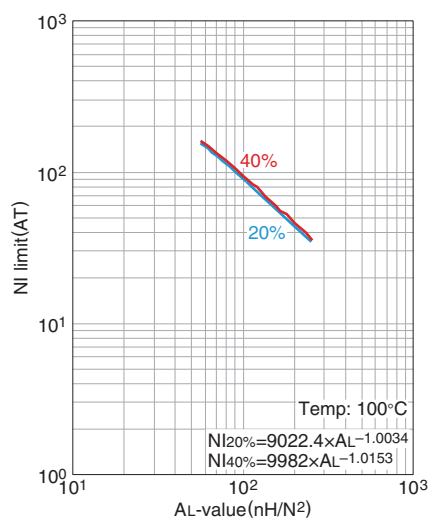

The 20% and 40% graph shows when a 20% and 40% drop from the initial AL-value has been made due to the DC superimposition.

AL-value vs. Air gap length (Typ.)

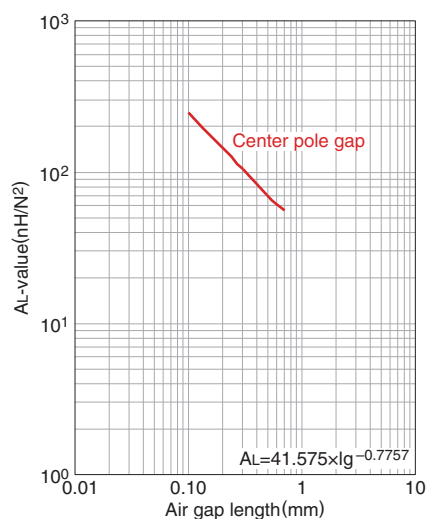

Measuring conditions

- Coil : $\phi 0.18$ 2UEW 100Ts
- Frequency : 1kHz
- Current level : 0.5mA
- Ambient temperature : 25°C

Mn-Zn Planar series Part No.: PC95ER14/4.5/9-Z

■ SHAPES AND DIMENSIONS

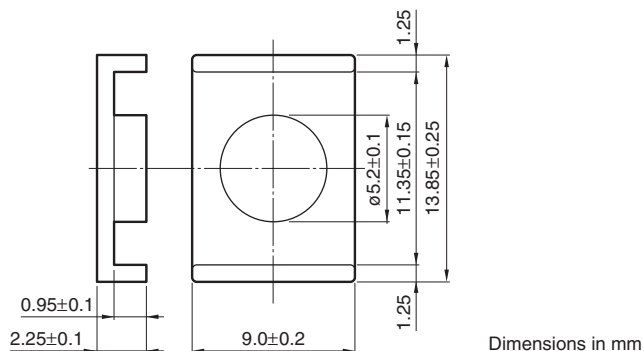

Effective parameter						Electrical characteristics				
Core factor	Effective magnetic path length	Effective cross-sectional area	Effective core volume	Cross-sectional winding area of core	Weight	AL-value *	Core loss			
C ₁ (mm ⁻¹)	ℓ _e (mm)	A _e (mm ²)	V _e (mm ³)	A _{cw} (mm ²)	(g/set)	(nH/N ²) 1kHz 0.5mA	(W)max. 100kHz 200mT	25°C	80°C	120°C
0.679	15.4	22.7	349	5.84	2.0	2550±25%	0.25	0.2	0.25	

NI limit vs. AL-value (Typ.)

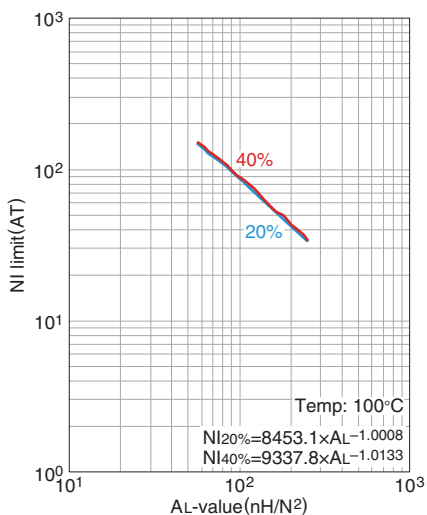

The 20% and 40% graph shows when a 20% and 40% drop from the initial AL-value has been made due to the DC superimposition.

AL-value vs. Air gap length (Typ.)

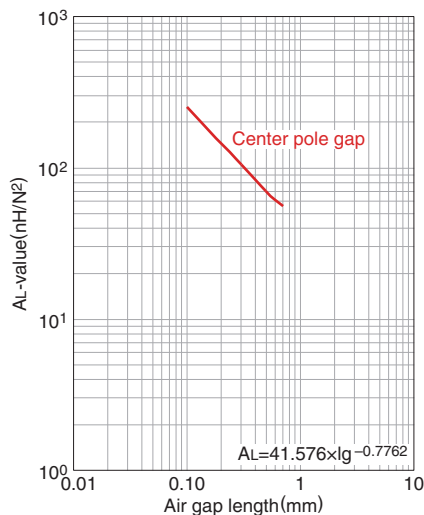

- Measuring conditions
- Coil : ø0.18 2UEW 100Ts
 - Frequency : 1kHz
 - Current level : 0.5mA
 - Ambient temperature : 25°C

⚠ Please be sure to request delivery specifications that provide further details on the features and specifications of the products for proper and safe use. Please note that the contents may change without any prior notice due to reasons such as upgrading.

Mn-Zn Planar series Part No.: PC95ER14.5/6-Z

SHAPES AND DIMENSIONS

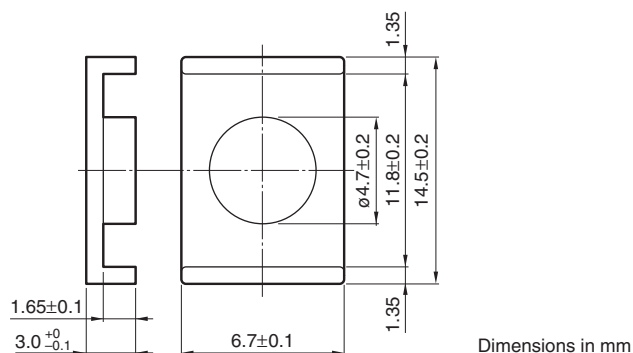

Effective parameter						Electrical characteristics				
Core factor	Effective magnetic path length	Effective cross-sectional area	Effective core volume	Cross-sectional winding area of core	Weight	AL-value *	Core loss			
C_1 (mm ⁻¹)	ℓ_e (mm)	A_e (mm ²)	V_e (mm ³)	A_{cw} (mm ²)	(g/set)	(nH/N ²) 1kHz 0.5mA	(W)max. 100kHz 200mT	25°C	80°C	120°C
1.08	19.0	17.6	333	8.42	2.0	3500±25%	0.3	0.28	0.3	

NI limit vs. AL-value (Typ.)

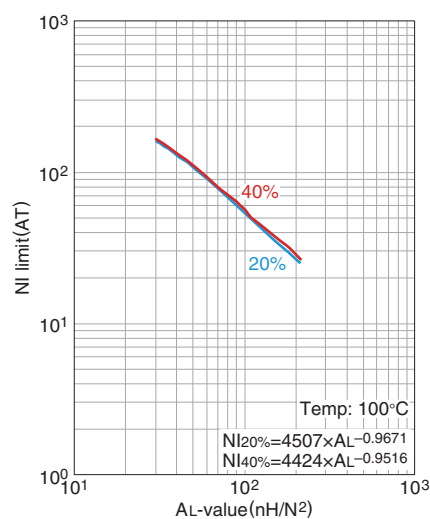

The 20% and 40% graph shows when a 20% and 40% drop from the initial AL-value has been made due to the DC superimposition.

AL-value vs. Air gap length (Typ.)

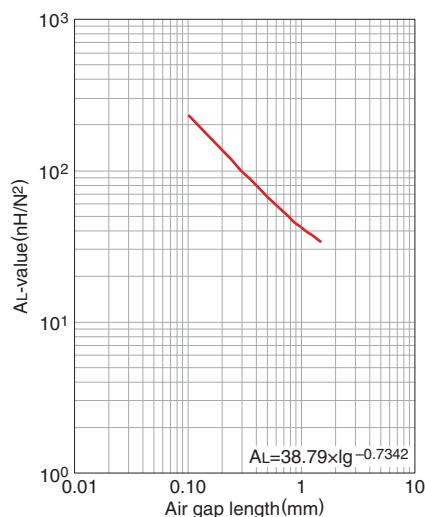

Measuring conditions

- Coil : $\phi 0.18$ 2UEW 100Ts
- Frequency : 1kHz
- Current level : 0.5mA
- Ambient temperature : 25°C

Mn-Zn Planar series Part No.: PC90ER18/5/12-Z

SHAPES AND DIMENSIONS

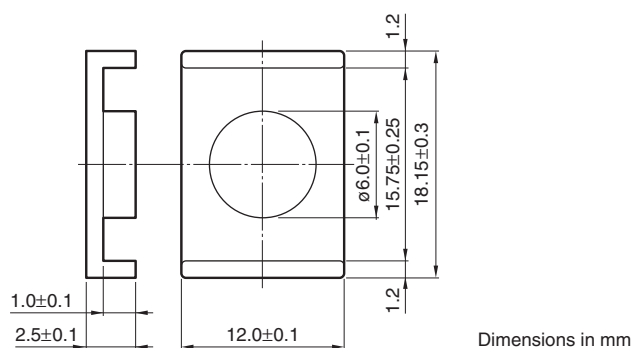

Effective parameter						Electrical characteristics	
Core factor	Effective magnetic path length	Effective cross-sectional area	Effective core volume	Cross-sectional winding area of core	Weigh	AL-value *	Core loss
C_1 (mm^{-1})	ℓ_e (mm)	A_e (mm^2)	V_e (mm^3)	A_{cw} (mm^2)	(g/set)	(nH/N^2) 1kHz 0.5mA	(W)max. 100kHz 200mT 100°C
0.601	19.7	32.8	645	9.75	3.8	2900±25%	0.5

NI limit vs. AL-value (Typ.)

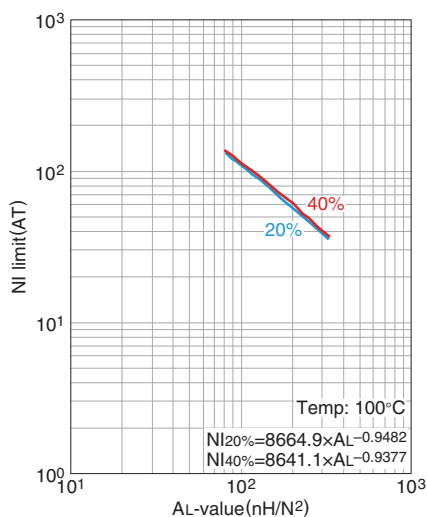

The 20% and 40% graph shows when a 20% and 40% drop from the initial AL-value has been made due to the DC superimposition.

AL-value vs. Air gap length (Typ.)

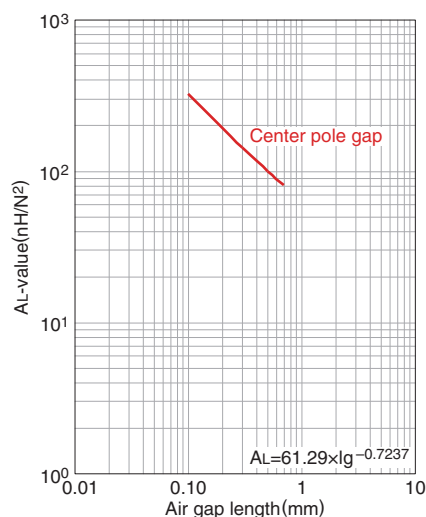

Measuring conditions

- Coil : $\phi 0.18$ 2UEW 100Ts
- Frequency : 1kHz
- Current level : 0.5mA
- Ambient temperature : 25°C

Mn-Zn Planar series Part No.: PC95ER18/5/12-Z

SHAPES AND DIMENSIONS

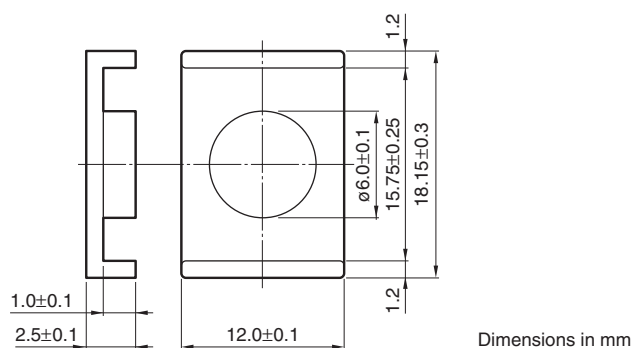

Effective parameter						Electrical characteristics				
Core factor	Effective magnetic path length	Effective cross-sectional area	Effective core volume	Cross-sectional winding area of core	Weight	AL-value *	Core loss			
C_1 (mm ⁻¹)	ℓ_e (mm)	A_e (mm ²)	V_e (mm ³)	A_{cw} (mm ²)	(g/set)	(nH/N ²) 1kHz 0.5mA	(W)max. 100kHz 200mT	25°C	80°C	120°C
0.601	19.7	32.8	645	9.75	3.8	3500±25%	0.45	0.4	0.45	

NI limit vs. AL-value (Typ.)

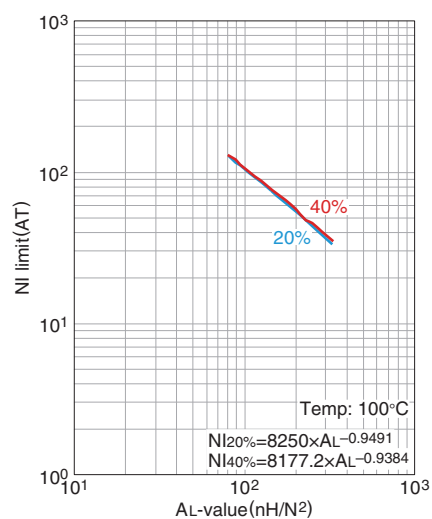

The 20% and 40% graph shows when a 20% and 40% drop from the initial AL-value has been made due to the DC superimposition.

AL-value vs. Air gap length (Typ.)

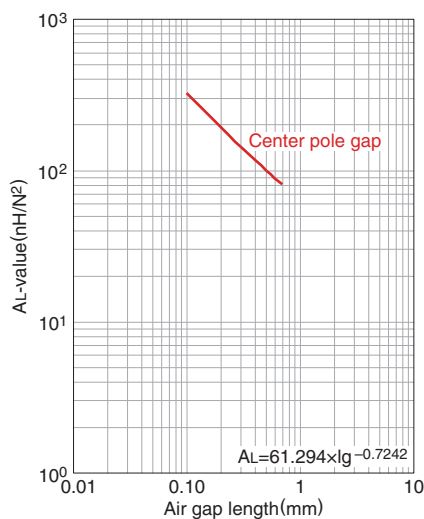

Measuring conditions

- Coil : $\phi 0.18$ 2UEW 100Ts
- Frequency : 1kHz
- Current level : 0.5mA
- Ambient temperature : 25°C

Mn-Zn EI Cores

SHAPES AND DIMENSIONS

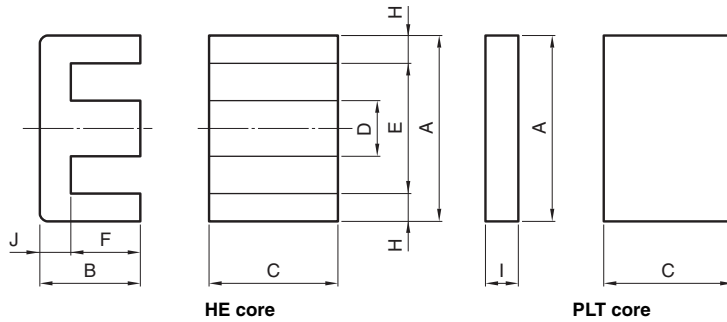

PC95	EI14/5/5	-	Z
Material	Size of E core		AL-value (Z: without air gap)

Part No.(HE+PLT)	Dimensions (mm)									
	A	B	C	D	E	F	H	I	J	
PC95EI14/5/5-Z	14.00±0.30	3.50±0.10	5.00±0.10	3.00±0.10	11.00±0.25	2.00±0.10	1.50	1.50±0.05	1.50	
PC90EI14/5/5-Z										
PC95EI18/6/10-Z	18.00±0.35	4.00±0.10	10.00±0.20	4.00±0.10	14.00±0.30	2.00±0.10	2.00	2.00±0.05	2.00	
PC90EI18/6/10-Z										
PC95EI22/8/16-Z	21.80±0.40	5.70±0.10	15.80±0.30	5.00±0.10	16.80±0.40	3.20±0.10	2.50	2.50±0.05	2.50	
PC90EI22/8/16-Z										

Part No.(HER+HER)	Effective parameter							Electrical characteristics	
	Core factor	Effective magnetic path length ℓ_e (mm)	Effective cross-sectional area A_e (mm ²)	Effective core volume V_e (mm ³)	A_{min} . (mm ²)	A_{cw} (mm ²)	Weigh (g)	AL-value	
	C_1 (mm ⁻¹)							(nH/N ²) 1kHz 0.5mA 100Ts	
PC95EI14/5/5-Z	1.11	16.7	15.0	251	15.0	8.00	1.3	1550±25%	63±3%
PC90EI14/5/5-Z								1200±25%	100±5% 160±7%
PC95EI18/6/10-Z	0.507	20.3	40.0	811	40.0	10.0	4.4	4720±25%	100±3%
PC90EI18/6/10-Z								3100±25%	160±3% 250±5%
PC95EI22/8/16-Z	0.330	26.1	79.0	2060	79.0	18.9	11	8010±25%	160±3%
PC90EI22/8/16-Z								5300±25%	250±3% 315±3%

 Please be sure to request delivery specifications that provide further details on the features and specifications of the products for proper and safe use.
Please note that the contents may change without any prior notice due to reasons such as upgrading.

Mn-Zn Planar series Part No.: PC90E14/5/5-Z

SHAPES AND DIMENSIONS

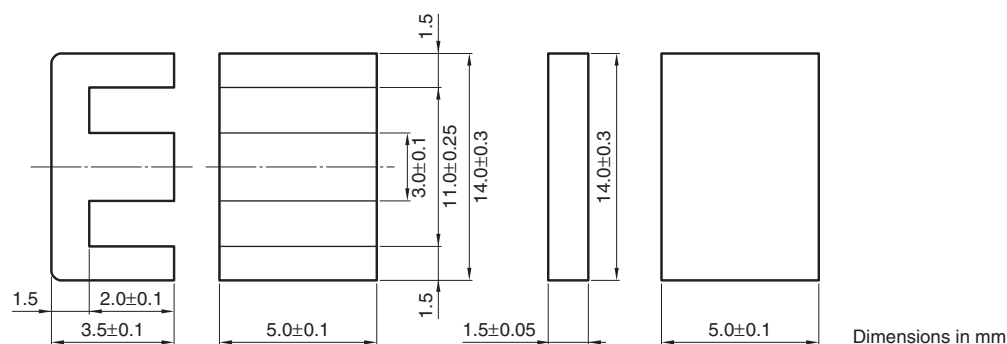

Effective parameter						Electrical characteristics	
Core factor	Effective magnetic path length	Effective cross-sectional area	Effective core volume	Cross-sectional winding area of core	Weigh	AL-value *	Core loss
C_1 (mm ⁻¹)	ℓ_e (mm)	A_e (mm ²)	V_e (mm ³)	A_{cw} (mm ²)	(g/set)	(nH/N ²) 1kHz 0.5mA	(W)max. 100kHz 200mT 100°C
1.11	16.7	15.0	251	8.0	1.3	1200±25%	0.3

NI limit vs. AL-value (Typ.)

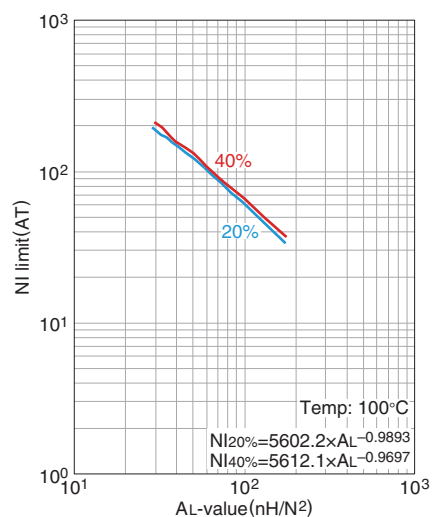

The 20% and 40% graph shows when a 20% and 40% drop from the initial AL-value has been made due to the DC superimposition.

AL-value vs. Air gap length (Typ.)

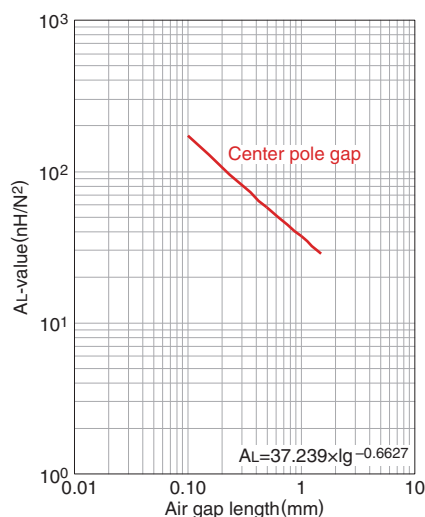

Measuring conditions

- Coil : $\phi 0.18$ 2UEW 100Ts
- Frequency : 1kHz
- Current level : 0.5mA
- Ambient temperature : 25°C

Mn-Zn Planar series Part No.: PC95E14/5/5-Z

SHAPES AND DIMENSIONS

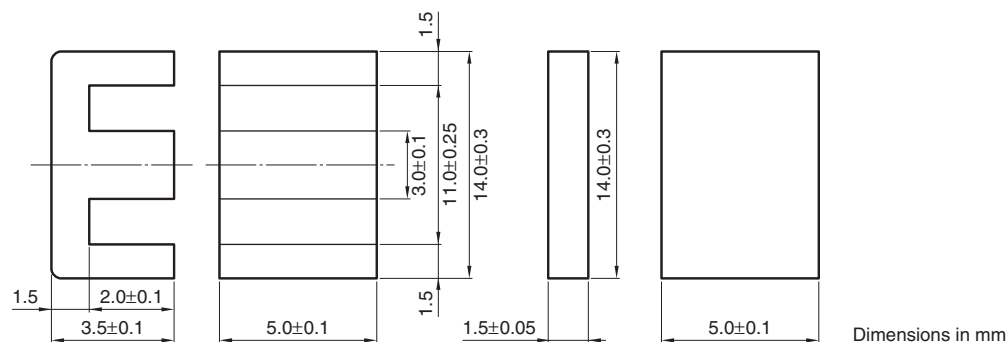

Effective parameter						Electrical characteristics				
Core factor	Effective magnetic path length	Effective cross-sectional area	Effective core volume	Cross-sectional winding area of core	Weight	AL-value *	Core loss			
C_1 (mm ⁻¹)	ℓ_e (mm)	A_e (mm ²)	V_e (mm ³)	A_{cw} (mm ²)	(g/set)	(nH/N ²) 1kHz 0.5mA	(W)max. 100kHz 200mT	25°C	80°C	120°C
1.11	16.7	15.0	251	8.0	1.3	1550±25%	0.3	0.25	0.3	

NI limit vs. AL-value (Typ.)

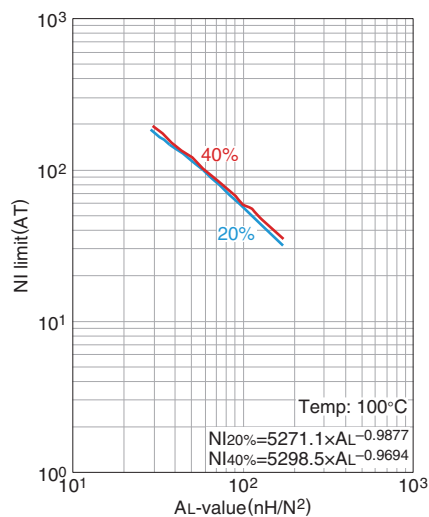

The 20% and 40% graph shows when a 20% and 40% drop from the initial AL-value has been made due to the DC superimposition.

AL-value vs. Air gap length (Typ.)

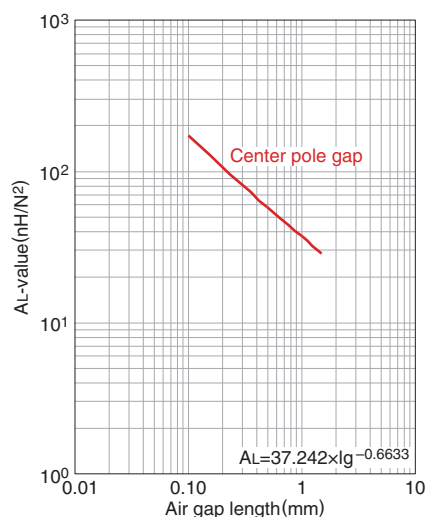

Measuring conditions

- Coil : $\phi 0.18$ 2UEW 100Ts
- Frequency : 1kHz
- Current level : 0.5mA
- Ambient temperature : 25°C