

HFBR-1525EZ Transmitter

HFBR-2525EZ Receiver

12 Megabaud Versatile Link Fiber Optic Transmitter and Receiver for 1 mm POF and 200 μm HCS[®]



Data Sheet



Description

The HFBR-1525EZ transmitter is an LED in a low cost plastic housing designed to efficiently couple power into 200 μm diameter Hard Clad Silica (HCS[®]) and 1 mm diameter Plastic optical fiber (POF). The HFBR-2525EZ receiver incorporates a PIN detector and digital output IC compatible with CMOS and TTL logic families.

HFBR-1525EZ/HFBR-2525EZ links operate from DC to 12 MBd at distances up to 50 meters with 1 mm POF and up to 500 meters with 200 μm HCS[®]. No minimum link distances are required when using recommended circuits, simplifying design.

Versatile Link components can be interlocked (N-plexed together) to minimize space and to provide dual connections with the duplex connectors. Up to eight packages can be interlocked and inserted into a printed circuit board.

POF and HCS[®] are available in pre-connected lengths or can be easily field-terminated. A single transmitter drive current for POF and HCS[®] allows both fibers to be used with a single design.

Features

- RoHS-compliant
- Data transmission at signal rates of dc to 12 MBd
- Up to 50 meters distances with 1 mm Plastic Optical Fiber (POF)
- Up to 500 meters distances with 200 μm Hard Clad Silica (HCS[®])
- Wide dynamic range receiver allows operation from zero to maximum link distance with a single transmitter drive current
- Link distances specified for variations in temperature, power supply, and fiber attenuation
- DC coupled receiver with CMOS/TTL output for easy designs: No data encoding or digitizing circuitry required
- Pulse width distortion (PWD) controlled to limit distortion from low duty cycle or burst mode data
- High noise immunity
- Compatible with Avago's versatile link family of connectors, for easy termination of fiber

Applications

- Industrial control and factory automation
- Serial field buses
- Intra-system links; board-to-board, rack-to-rack
- Extension of RS-232, RS-485
- Elimination of ground loops
- High voltage isolation
- Reduces voltage transient susceptibility

HCS[®] is a registered trademark of OFS.

CAUTION: It is advised that normal static precautions be taken in handling and assembly of these components to prevent damage and/or degradation which may be induced by ESD.

HFBR-1525EZ/2525EZ Series 12 MBd Data Link

Typical Link Performance, $T_A = +25^\circ\text{C}$

Parameter	Symbol	Typ. ^[1]	Unit	Condition	Note
Signaling Rate	f_s	12	Mb/s	NRZ	2
Link Distance with Extra Low Loss POF Cable	L_d	50	m	12 MBd	2, 3, 5
Link Distance with 200 μm HCS Cable	L_d	500	m	12 MBd	2, 4, 5

Specified Link Performance, $T_A = -40^\circ$ to $+85^\circ\text{C}$, DC to 12 MBd, unless otherwise noted.

Parameter	Symbol	Min.	Max.	Unit	Condition	Note
Signaling Rate	f_s	DC	12	Mb/s	NRZ	2
Link Distance with Extra Low Loss POF Cable	L_d	0.1	50	m	+25°C 0 to +70°C -40 to +85°C	2, 3, 5
Link Distance with 200 μm HCS Cable	L_d	0.1	500	m	+25°C 0 to +70°C -40 to +85°C	2, 4, 5
Pulse Width Distortion	PWD	-30	+30	ns	25 – 75% Duty Cycle	2
		-50	+50	ns	Arbitrary Duty Cycle	

Absolute Maximum Ratings

Parameter	Symbol	Min.	Max.	Unit	Note
Storage and Operating Temperature	$T_{s,o}$	-40	+85	°C	
Receiver Supply Voltage	V_{cc}	-0.5	+5.5	V	
Receiver Average Output Current	$I_{O,AVG}$	-16	+16	mA	
Receiver Output Power Dissipation	P_{OD}		80	mW	
Transmitter Peak Forward Input Current	I_{FPK}		90	mA	6
Transmitter Average Forward Input Current	I_{FAVG}		60	mA	
Transmitter Reverse Input Voltage	V_R		3	V	
Lead Soldering Cycle	Temp	T_{SOL}	+260	°C	7, 8
		Time	10	sec	7, 8

Recommended Operating Conditions

Parameter	Symbol	Min.	Max.	Unit	Condition	Note
Ambient Temperature	T_A	-40	+85	°C		
Power Supply Voltage	V_{cc}	4.75	5.25	V	<100 mV _{p-p} Noise	
Transmitter Peak Forward Current	I_{FPK}	20	90	mA		6
Transmitter Average Forward Current	I_{FAV}		60	mA		

Notes:

- Typical data at $+25^\circ\text{C}$, $V_{cc} = 5\text{ V}$.
- With recommended transmitter and receiver application circuits (60 mA nominal drive current).
- POF is HFBR-R/EXXYYYY plastic (1 mm) optical fiber. Worst case attenuation used (0.23 dB/m from -40°C to $+85^\circ\text{C}$ at 660 nm).
- HCS is HFBR-H/VXYYYY hard clad silica (200/230 μm) fiber. Worst case attenuation is used (10 dB/km from 0°C to $+70^\circ\text{C}$ and 12 dB/km from -40°C to $+85^\circ\text{C}$ at 650 nm).
- $\text{BER} \leq 10^{-9}$, $2^{23} - 1$ PRBS NRZ 12 MBd.
- For $I_{FPK} > 60\text{ mA}$, the duty factor must maintain $I_{FAV} \leq 60\text{ mA}$ and pulse width $\leq 1\ \mu\text{s}$.
- 1.6 mm below seating plane.
- Moisture sensitivity level (MSL) is 3 for HFBR-1525EZ/HFBR-2525EZ.

HFBR-1525EZ Transmitter

The HFBR-1525EZ transmitter incorporates a 650 nm LED in a light gray, nonconductive plastic housing. The high light output power enables the use of both plastic optical fiber (POF) and Hard Clad Silica (HCS®) fiber. This transmitter can be operated up to 12 MBd using a simple driver circuit. The HFBR-1525EZ is compatible with all Versatile Link connectors.

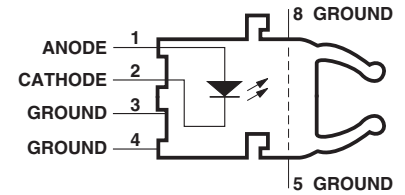

HFBR-1525EZ Transmitter, top view

Electrical and Optical Characteristics: $T_A = -40^\circ$ to $+85^\circ\text{C}$ unless otherwise noted.

Parameter	Symbol	Min.	Typ. ^[1]	Max.	Units	T_A ($^\circ\text{C}$)	Conditions	Note
Peak Output Power 1 mm POF, 60 mA	P_T	-6.0	-3.5	0.0	dBm	+25	$I_{F,dc} = 60$ mA	2, 3 Fig. 2
		-6.9		+0.5		0 to +70		
		-7.2		+1.3		-40 to +85		
Peak Output Power 1 mm POF, 20 mA	P_T	-15.6	-9.0	-2.0	dBm	+25	$I_{F,dc} = 20$ mA	2, 3 Fig. 2
		-16.5		-1.5		0 to +70		
		-16.8		-0.7		-40 to +85		
Peak Output Power 200 μm HCS, 60 mA	P_T	-16.1	-12.5	-8.5	dBm	+25	$I_{F,dc} = 60$ mA	2, 3 Fig. 2
		-17.0		-8.0		0 to +70		
		-17.3		-7.2		-40 to +85		
Optical Power Tem- perature Coefficient	$\Delta P_T / \Delta T$		-0.40					
			-0.02			$\% / ^\circ\text{C}$ dB/ $^\circ\text{C}$		
Peak Emission Wavelength	λ_p	640	650	660	nm	0 to +70		Fig. 3
		635		662		-40 to +85		
Peak Wavelength Temperature Coefficient	$\Delta \lambda / \Delta T$		0.12					
Spectral Width	FWHM		21		nm			Fig. 3
Forward Voltage	V_F	1.8	2.1	2.65	V		$I_{F,dc} = 60$ mA	Fig. 1
Forward Voltage Tem- perature Coefficient	$\Delta V_F / \Delta T$		-1.8		mV/ $^\circ\text{C}$			Fig. 1
Reverse Input Break- down Voltage	V_{BR}	3.0	13		V		$I_{F,dc} = -10$ μA	
Diode Capacitance	C_O		60		pF		$V_F = 0$ V, $f = 1$ MHz	
Transmitter Numerical Aperture	NA		0.5					
Thermal Resistance, Junction to Case	θ_{jc}		140		$^\circ\text{C}/\text{W}$			4
Optical Rise Time	t_r		13		ns		10% to 90%, $I_F = 60$ mA	
Optical Fall Time	t_f		10		ns			

Notes:

- Typical data are at 25°C .
- Optical power measured at the end of 0.5 meters of 1 mm diameter plastic or 200 μm diameter hard clad silica fiber with a large area detector.
- Minimum and maximum values for P_T over temperature are based on a fixed drive current. The recommended drive circuit has temperature compensation which reduces the variation in P_T over temperature; refer to Figures 4 and 6.
- Typical value measured from junction to PC board solder joint for horizontal mount package, HFBR-1525EZ.
- Pins 5 and 8 are for mounting and retaining purposes, but are electrically connected; pins 3 and 4 are electrically isolated. It is recommended that pins 3, 4, 5 and 8 all be connected to ground to reduce coupling of electrical noise.
- Refer to the "Plastic Optical Fiber and HCS Fiber Cable and Connectors for Versatile Link" Technical Data Sheet for cable connector options for 1 mm plastic and 200 μm HCS optical fiber.

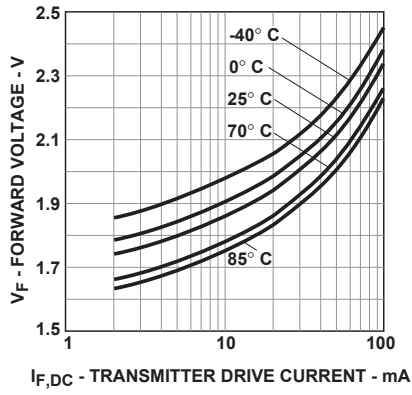

Figure 1. Typical forward voltage vs. drive current

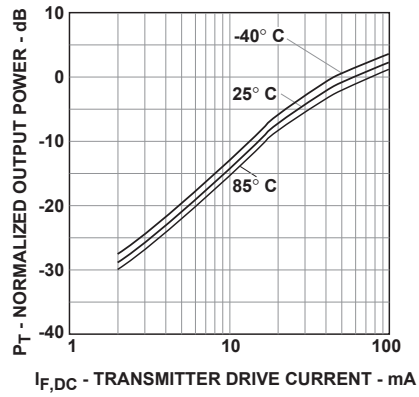

Figure 2. Typical normalized optical power vs. drive current

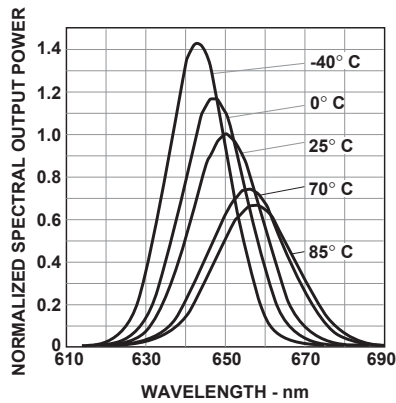

Figure 3. Typical normalized optical spectra

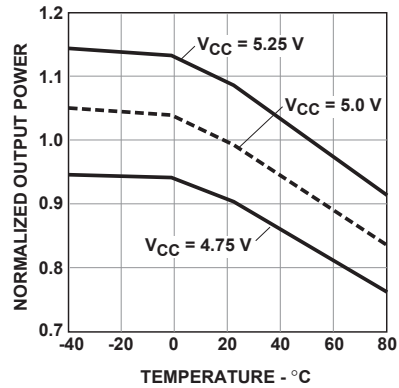

Figure 4. Typical normalized optical power vs. temperature (in recommended drive circuit)

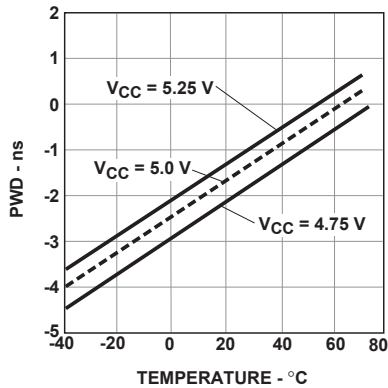

Figure 5. Typical optical pulse width distortion vs. temperature and power supply voltage (in recommended drive circuit)

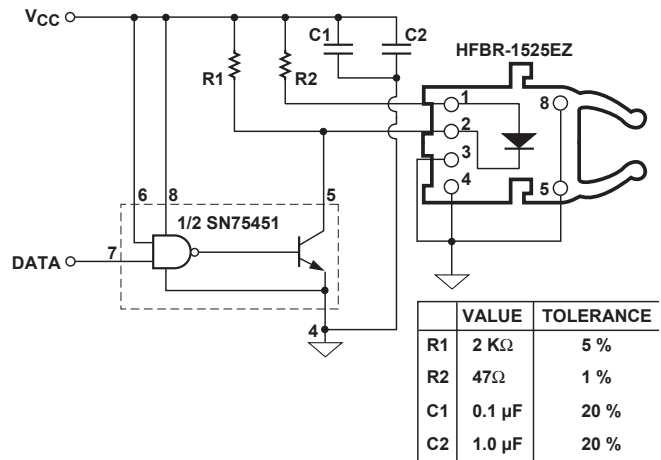

Figure 6. Recommended transmitter drive circuit ($I_{F,on} = 60 \text{ mA}$ nominal at $T_A = 25^\circ\text{C}$)

WARNING: WHEN VIEWED UNDER SOME CONDITIONS, THE OPTICAL PORT MAY EXPOSE THE EYE BEYOND THE MAXIMUM PERMISSIBLE EXPOSURE RECOMMENDED IN ANSI Z136.2, 1993. UNDER MOST VIEWING CONDITIONS THERE IS NO EYE HAZARD.

HFBR-2525EZ Receiver

The HFBR-2525EZ receiver consists of a silicon PIN photodiode and digitizing IC to produce a logic compatible output. The IC includes a unique circuit to correct the pulse width distortion (PWD) of the first bit after a long idle period. This enables operation from DC to 12 MBd with low PWD for arbitrary data patterns.

The receiver output is a “push-pull” stage compatible with TTL and CMOS logic. The receiver housing is a dark, conductive plastic, compatible with all Versatile Link connectors.

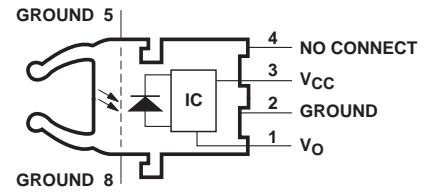

SEE NOTES 5,7

HFBR-2525EZ Receiver, top view

Electrical and Optical Characteristics: $T_A = -40^\circ$ to $+85^\circ\text{C}$, $4.75\text{ V} < V_{CC} < 5.25\text{ V}$, unless otherwise noted.

Parameter	Symbol	Min.	Typ ⁽¹⁾	Max.	Unit	T_A (°C)	Condition	Note	Fig.
Peak POF Sensitivity: Minimum Input for Logic “0”	$P_{RL,min}$		-23.0	-21.0 -20.0 -19.5	dBm	+25 0 to +70 -40 to +85	1 mm POF, $ PWD < 30\text{ ns}$	2,6	8,10
Peak POF Overdrive Limit: Maximum Input for Logic “0”	$P_{RL,max}$	+1.0 +0.0 -1.0	+5.0		dBm	+25 0 to +70 -40 to +85	1 mm POF, $ PWD < 30\text{ ns}$	2,3,6	7,8,9
Peak POF Off State Limit: Maximum Input for Logic “1”	$P_{RH,max}$			-42	dBm		1 mm POF	2,6,8	
Peak HCS Sensitivity: Minimum Input for Logic “0”	$P_{RL,min}$		-25.0	-23.0 -22.0 -21.5	dBm	+25 0 to +70 -40 to +85	200 μm HCS®, $ PWD < 30\text{ ns}$	2,6	
Peak HCS Overdrive Limit: Maximum Input for Logic “0”	$P_{RL,max}$	-1.0 -2.0 -3.0	+3.0		dBm	+25 0 to +70 -40 to +85	200 μm HCS®, $ PWD < 30\text{ ns}$	2,3,6	
Peak HCS Off State Limit: Maximum Input for Logic “1”	$P_{RH,max}$			-44	dBm		200 μm HCS®	2,6,8	
Supply Current	I_{CC}		19	45	mA		$V_O = \text{Open}$		
High Level Output Voltage	V_{OH}	4.2	4.7		V		$I_O = -40\ \mu\text{A}$		
Low Level Output Voltage	V_{OL}		0.22	0.4	V		$I_O = +1.6\text{ mA}$		
Output Rise Time	t_r		12	30	ns		$C_L = 10\text{ pF}$	6	
Output Fall Time	t_f		10	30	ns		$C_L = 10\text{ pF}$	6	
Thermal Resistance, Junction to Case	θ_{jc}		200		°C/W			4	
Electric Field Immunity	E_{MAX}		8		V/m		Near Field, Electrical Field Source	5	
Power Supply Noise Immunity	PSNI	0.1	0.4		V_{pp}		Sine Wave DC - 10 MHz	6	

Notes:

- Typical data are at $+25^\circ\text{C}$, $V_{CC} = 5.0\text{ V}$.
- Input power levels are for peak (not average) optical input levels. For 50% duty cycle data, peak optical power is twice the average optical power.
- Receiver overdrive ($P_{RL,max}$) is specified as the limit where $|PWD|$ will not exceed 30 ns. The receiver will be in the correct state (logic “0”) for optical powers above $P_{RL,max}$. However, it may not meet a 30% symbol period PWD if the overdrive limit is exceeded. Refer to Figure 8 for PWD performance at high received optical powers.
- Typical value measured from junction to PC board solder joint for horizontal mount package, HFBR-2525EZ.
- Pins 5 and 8 are electrically connected to the conductive housing and are also used for mounting and retaining purposes. It is required that pins 5 and 8 be connected to ground to maintain conductive housing shield effectiveness.
- In recommended receiver circuit, with an optical signal from the recommended transmitter circuit.
- Pin 4 is electrically isolated internally. Pin 4 may be externally connected to pin 1 for board layout compatibility with HFBR-25X1Z, HFBR-25X2Z and HFBR-25X4Z. Otherwise it is recommended pin 4 be grounded as in Figure 11.
- $BER \leq 10E-9$, includes a 10.8 dB margin below the receiver switching threshold level (signal to noise ratio = 12).

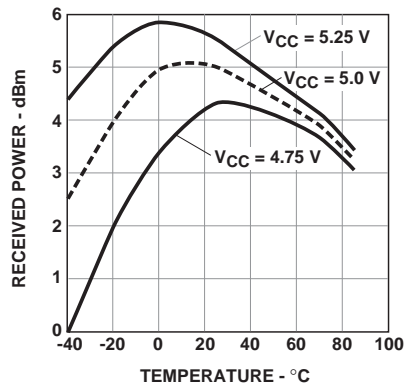

Figure 7. Typical POFR receiver overdrive, $P_{RL,max}$, at 12 MBd, vs. temperature and power supply voltage

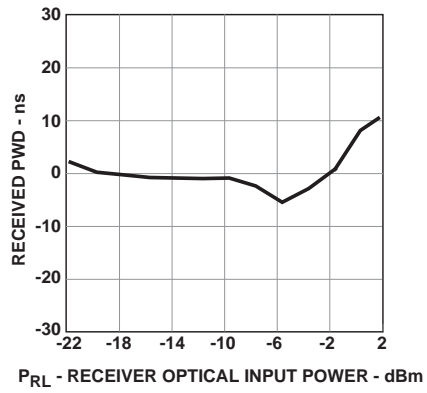

Figure 8. Typical POFR receiver pulse width distortion vs. optical power at 12 MBd

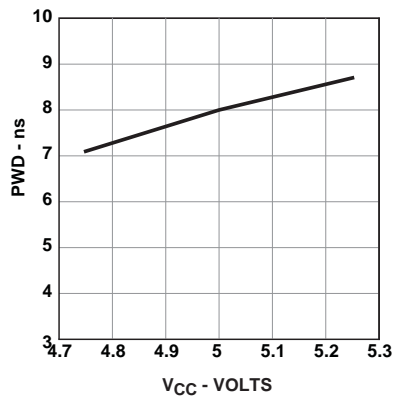

Figure 9. Typical POFR receiver pulse width distortion vs. power supply voltage at high optical power (0 dBm,pk, 12 MBd)

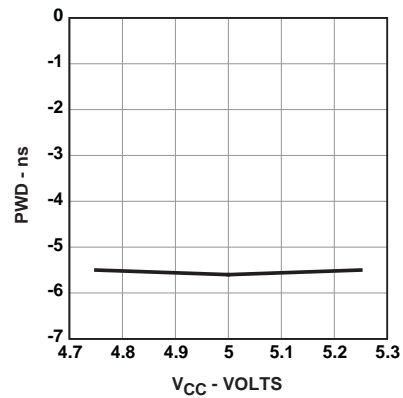

Figure 10. Typical POFR receiver pulse width distortion vs. power supply voltage at mid optical power, (-6 dBm,pk, 12 MBd)

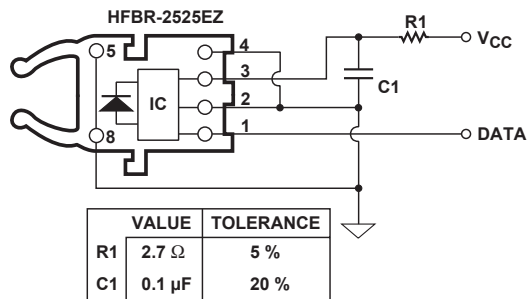

Figure 11. Recommended receiver application circuit

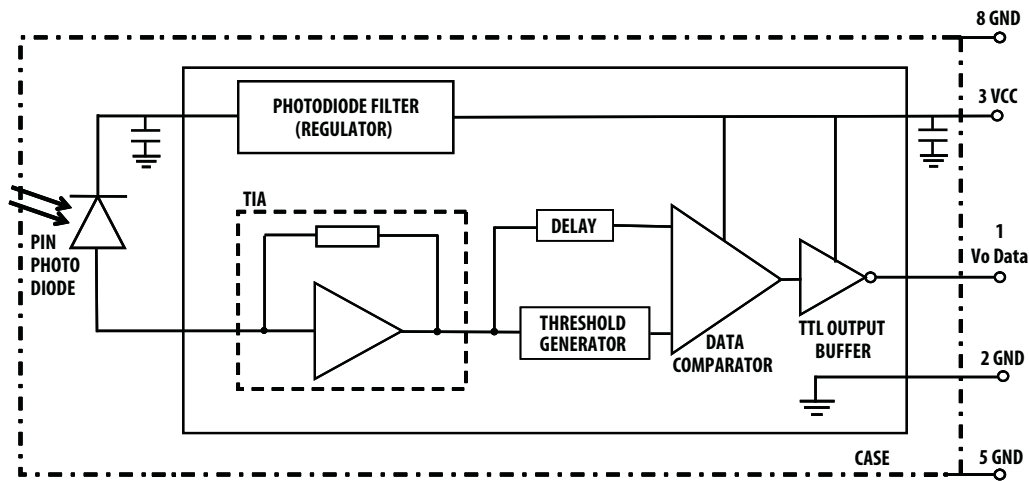
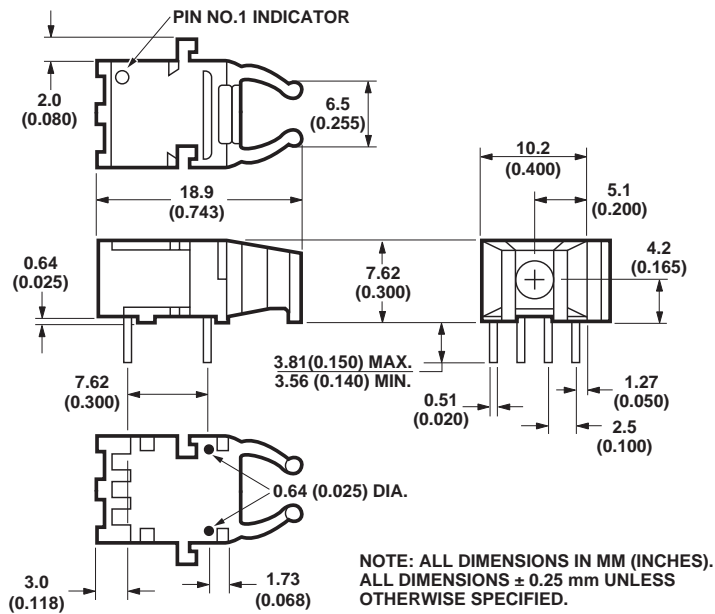
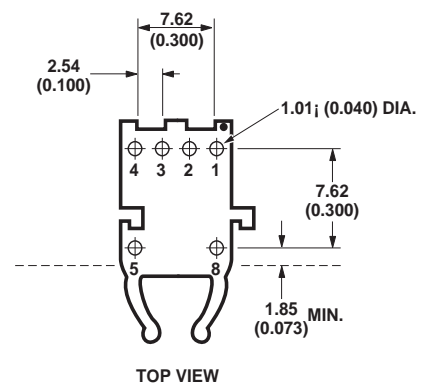

Figure 12. HFBR-2525EZ receiver block diagram

Versatile Link Mechanical Dimensions



Versatile Link Printed Circuit Board Layout Dimensions



ELECTRICAL PIN FUNCTIONS

PIN NO.	TRANSMITTER HFBR-1528	RECEIVER HFBR-2528
1	ANODE	SIGNAL, V_O
2	CATHODE	GROUND
3	GROUND*	V_{CC} (+5 V)
4	GROUND*	GROUND*
5	GROUND**	GROUND**
8	GROUND**	GROUND**

* NO INTERNAL CONNECTION,
GROUND CONNECTION RECOMMENDED.
** PINS 5 AND 8 CONNECTED INTERNALLY
TO EACH OTHER.

For product information and a complete list of distributors, please go to our website: www.avagotech.com

Avago, Avago Technologies, and the A logo are trademarks of Avago Technologies in the United States and other countries.
Data subject to change. Copyright © 2005–2012 Avago Technologies. All rights reserved. Obsoletes 5989-4632EN
AV02-3261EN - February 20, 2012

AVAGO
TECHNOLOGIES