

Low Power Dual Operational Amplifiers

GENERAL DESCRIPTION

The μPC1251/358 are dual operational amplifiers which are designed to operate from a single power supply over a wide range of voltages. Operation from split power supplies is also possible and the power supply current drain is very low. Further advantage, the input common-mode voltage includes ground and the output voltage can also swing to ground in the linear mode.

Two kinds of ICs are available according to reliability, the μPC1251 for industry, the μPC358 for commercial.

FEATURES

- Internal Frequency Compensation
- Large Output Voltage Swing
0 V to V^+ - 1.5 V DC
- Input Common-Mode Voltage Range Includes Ground
- Wide Power Supply Range
Single Supply 3 V to 30 V DC
- Dual Supplies ± 1.5 V to ± 15 V DC
- Low Power Consumption
- LM358 Direct Replacement

EQUIVALENT CIRCUIT

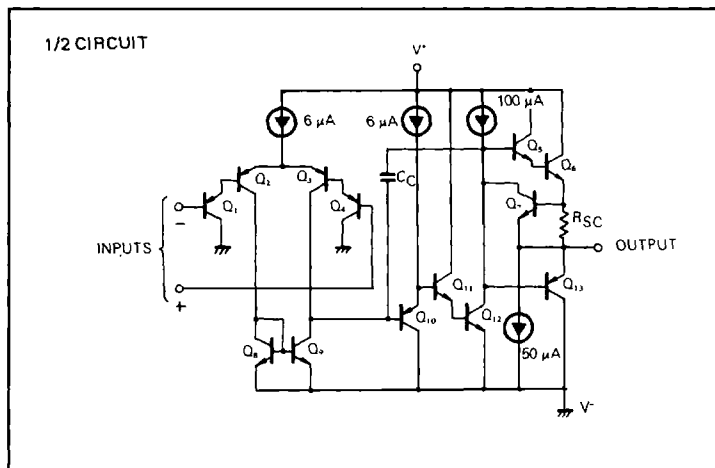

CONNECTION DIAGRAM (Top View)

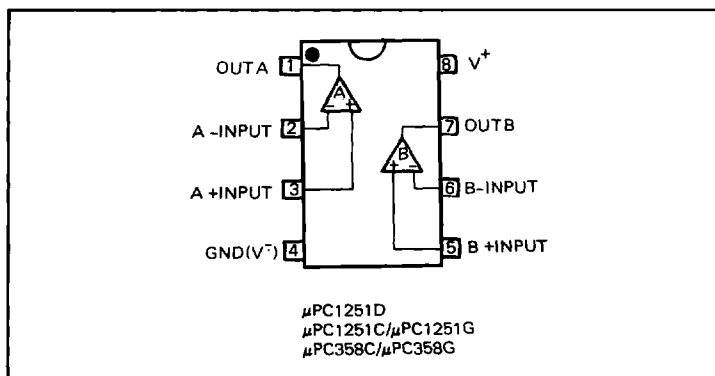

ORDERING INFORMATION

μPC1251D



8 pin Ceramic DIP
(Dual In-Line Package)

μPC1251C/μPC358C



8 pin Plastic Molded DIP
(Dual In-Line Package)

μPC1251G/μPC358G



8 pin Plastic Molded Flat Package
(MINI FLAT IC)

ABSOLUTE MAXIMUM RATINGS (Ta = 25°C)

PARAMETER		μPC1251	μPC358	UNIT
Voltage between V ⁺ and V ⁻		32	32	V
Differential Input Voltage		32	32	V
Input Voltage		-0.3 to +32	-0.3 to +32	V
Power Dissipation*	D Package	500	-	mW
	C Package	350	350	
	G Package	440	440	
Output Short Circuit Duration		Indefinite	Indefinite	s
Operating Temperature Range	D Package	-20 to +80	-	°C
	C or G Package	-20 to +70	0 to +70	
Storage Temperature Range	D Package	-55 to +150	-	°C
	C or G Package	-55 to +125	-55 to +125	

* See thermal information in chapter 11.

ELECTRICAL CHARACTERISTICS (Ta = 25°C, V⁺ = +5 V)

CHARACTERISTIC	MIN.	TYP.	MAX.	UNIT	CONDITIONS
Input Offset Voltage		2	7	mV	Rs = 0 Ω
Input Bias Current		45	250	nA	
Input Offset Current		5	50	nA	
Common Mode Input Voltage Range	0		V ⁺ -1.5	V	
Supply Current		0.7	1.2	mA	RL = ∞ on All Op Amps
Voltage Gain	25	100		V/mV	RL ≥ 2k Ω
Output Voltage Swing	0		V ⁺ -1.5	V	RL = 2 kΩ
Common Mode Rejection Ratio	65	70		dB	
Supply Voltage Rejection Ratio	65	100		dB	
Channel Separation		120			f = 1 kHz to 20 kHz
Output Current (SOURCE)	20	40		mA	V _{IN⁺} = 1 V, V _{IN⁻} = 0 V
Output Current (SINK)	10	20		mA	V _{IN⁻} = 1 V, V _{IN⁺} = 0 V
	12	50		μA	V _{IN⁻} = 1 V, V _{IN⁺} = 0 V, Vo = 200 mV



TYPICAL PERFORMANCE CHARACTERISTICS (Ta=25 °C)

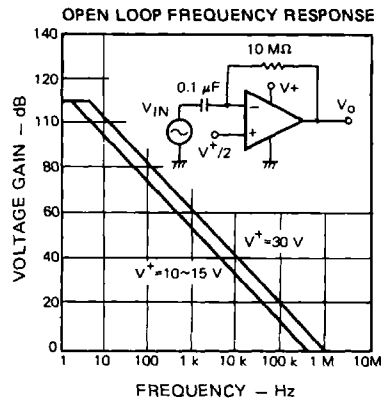
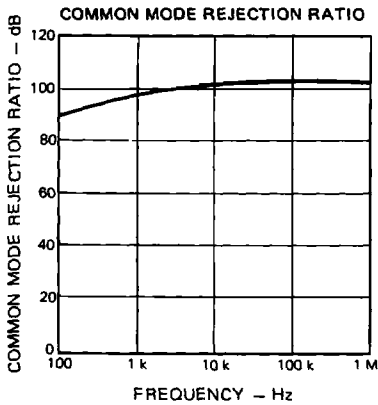
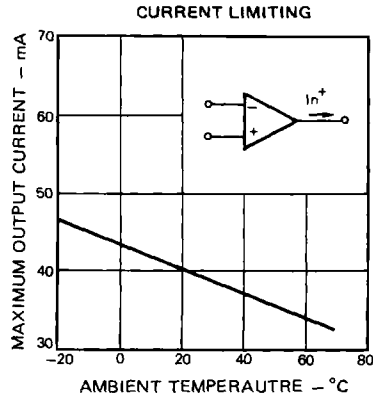
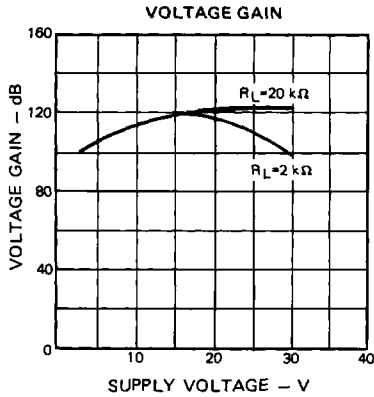
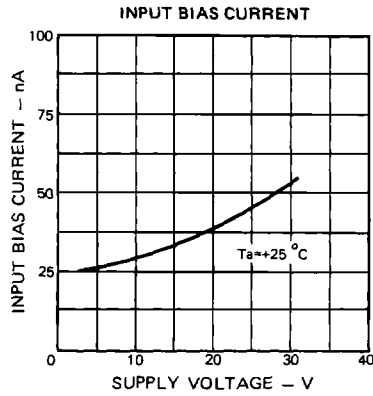
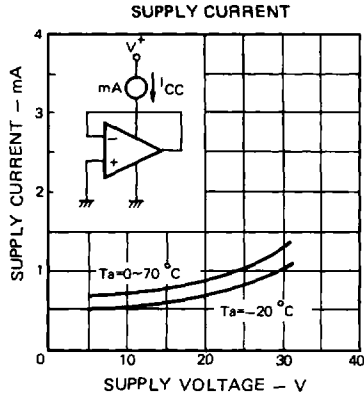

LARGE SIGNAL FREQUENCY RESPONSE

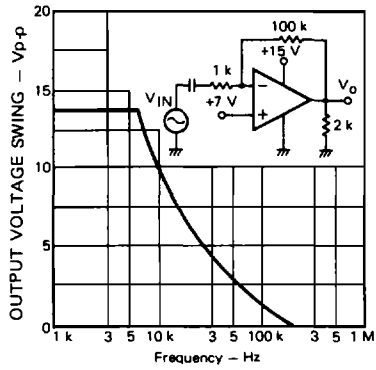

VOLTAGE FOLLOWER PULSE RESPONSE

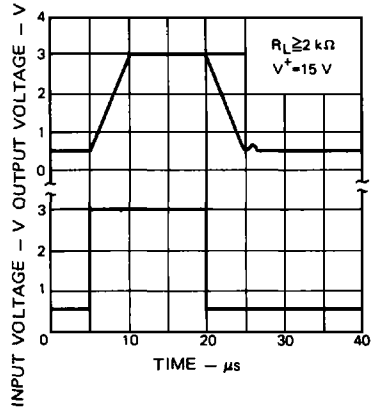

CURRENT SINKING

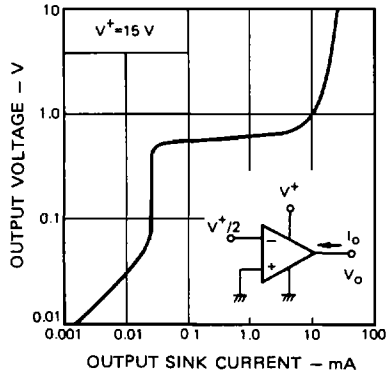

CURRENT SOURCING

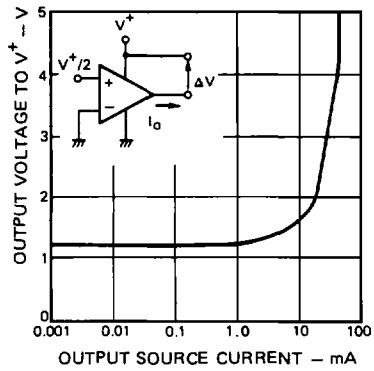

5