

## J-FET INPUT QUAD OP-AMPS

- LOW POWER CONSUMPTION
- WIDE COMMON-MODE AND DIFFERENTIAL VOLTAGE RANGE
- LOW INPUT BIAS AND OFFSET CURRENT
- OUTPUT SHORT-CIRCUIT PROTECTION
- HIGH INPUT IMPEDANCE J-FET INPUT STAGE
- INTERNAL FREQUENCY COMPENSATION
- LATCH UP FREE OPERATION
- HIGH SLEW RATE : 13 V/ $\mu$ s (typ)

### DESCRIPTION

These circuits are high speed J-FET input quad operational amplifiers incorporating well matched, high voltage J-FET and bipolar transistors in a monolithic integrated circuit.

The devices feature high slew rates, low input bias and offset current, and low offset voltage temperature coefficient.

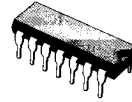

**N SUFFIX**  
 DIP14  
 (Plastic package)

**J SUFFIX**  
 CERDIP14  
 (Cerdip package)



**D SUFFIX**  
 SO14  
 (Plastic micropackage)



**GC SUFFIX**  
 LCC20  
 (Tricop LCC)

### PIN CONNECTIONS (Top views)

**DIP14  
 CERDIP14  
 SO14**

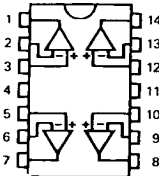

- |                           |                            |
|---------------------------|----------------------------|
| 1 - Output 1              | 8 - Output 3               |
| 2 - Inverting input 1     | 9 - Inverting input 3      |
| 3 - Non-inverting input 1 | 10 - Non-inverting input 3 |
| 4 - $V_{CC}$              | 11 - $V_{CC}$              |
| 5 - Non-inverting input 2 | 12 - Non-inverting input 4 |
| 6 - Inverting input 2     | 13 - Inverting input 4     |
| 7 - Output 2              | 14 - Output 4              |

**LCC20**

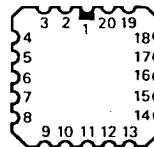

- |                           |                            |
|---------------------------|----------------------------|
| 1 - NC                    | 11 - NC                    |
| 2 - Output 1              | 12 - Output 3              |
| 3 - Inverting input 1     | 13 - Inverting input 3     |
| 4 - Non-inverting input 1 | 14 - Non-inverting input 3 |
| 5 - NC                    | 15 - NC                    |
| 6 - $V_{CC}$              | 16 - $V_{CC}$              |
| 7 - NC                    | 17 - NC                    |
| 8 - Non-inverting input 2 | 18 - Non-inverting input 4 |
| 9 - Inverting input 2     | 19 - Inverting input 4     |
| 10 - Output 2             | 20 - Output 4              |

**ORDER CODES**

Part Number	Temperature	Package
MC35004GC	- 55 °C to + 125 °C	LCC
MC35004AGC	- 55 °C to + 125 °C	LCC
MC35004BGC	- 55 °C to + 125 °C	LCC
MC35004J	- 55 °C to + 125 °C	CERDIP
MC35004AJ	- 55 °C to + 125 °C	CERDIP
MC35004BJ	- 55 °C to + 125 °C	CERDIP
MC33004N	- 40 °C to + 105 °C	DIP 14
MC33004AN	- 40 °C to + 105 °C	DIP 14
MC33004BN	- 40 °C to + 105 °C	DIP 14
MC33004D	- 40 °C to + 105 °C	SO 14
MC33004AD	- 40 °C to + 105 °C	SO 14
MC33004BD	- 40 °C to + 105 °C	SO 14
MC34004N	0 °C to + 70 °C	DIP 14
MC34004AN	0 °C to + 70 °C	DIP 14
MC34004BN	0 °C to + 70 °C	DIP 14
MC34004D	0 °C to + 70 °C	SO 14
MC34004AD	0 °C to + 70 °C	SO 14
MC34004BD	0 °C to + 70 °C	SO 14

**ABSOLUTE MAXIMUM RATINGS**

Symbol	Parameter	Value	Unit
V <sub>CC</sub>	Supply Voltage (note 1)	± 18	V
V <sub>i</sub>	Input Voltage (note 3)	± 15	V
V <sub>CC</sub>	Diff. Input Voltage (note 2)	± 30	V
P <sub>tot</sub>	Power Dissipation	680	mW
	Output Short-circuit Duration (note 4)	Infinite	
T <sub>oper</sub>	Operating Free Air Temperature Range	MC34004, A, B 0 to 70 MC33004, A, B - 40 to 105 MC35004, A, B - 55 to 125	°C
T <sub>stg</sub>	Storage Temperature Range	- 65 to 150	°C

- Notes :**
1. All voltage values, except differential voltage, are with respect to the zero reference level (ground) of the supply voltages where the zero reference level is the midpoint between V<sub>CC</sub> and V<sub>CC</sub>.
  2. Differential voltages are at the non-inverting input terminal with respect to the inverting input terminal.
  3. The magnitude of the input voltage must never exceed the magnitude of the supply voltage or 15 volts, whichever is less.
  4. The output may be shorted to ground or to either supply. Temperature and /or supply voltages must be limited to ensure that the dissipation rating is not exceeded.

**SCHEMATIC** (each amplifier)

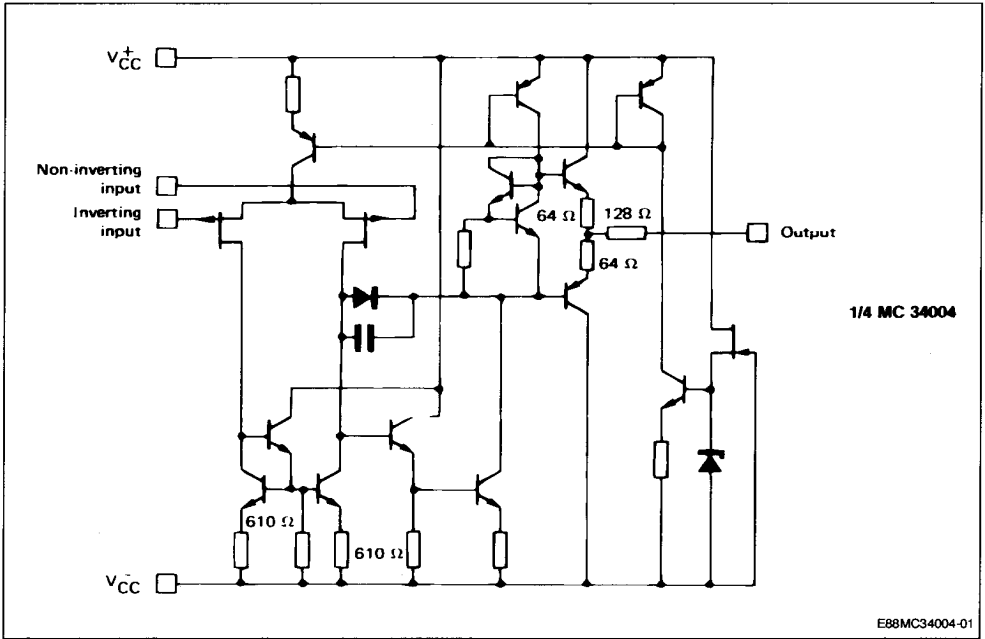

Case	Outputs	Inverting Inputs	Non-inverting Inputs	V <sub>cc</sub>	V <sub>cc</sub>	N.C.
DIP14 CERDIP14 SO14	1, 7, 14, 8	2, 6, 13, 9	3, 5, 12, 10	4	11	
LCC20	2, 10, 12, 20	3, 9, 13, 19		4, 8, 14, 18	6	16

\* LCC20 : Other pins are not connected.

**ELECTRICAL CHARACTERISTICS**

V<sub>CC</sub> = ± 15 V (unless otherwise specified)

MC35004, MC35004B, MC33004A - 55 ≤ T<sub>amb</sub> ≤ + 125 °C

MC33004, MC33004B, MC33004A - 40 ≤ T<sub>amb</sub> ≤ + 105 °C

MC34004, MC34004B, MC34004A 0 ≤ T<sub>amb</sub> ≤ + 70 °C

Symbol	Parameter	MC35004A, B MC33004A, B MC34004A, B			MC35004 MC33004 MC34004			Unit
		Min.	Typ.	Max.	Min.	Typ.	Max.	
V <sub>IO</sub>	Input Offset Voltage T <sub>amb</sub> = 25 °C (R <sub>S</sub> ≤ 10 kΩ) MC35004B, MC33004B, MC34004B MC35004A, MC33004A, MC34004A T <sub>min</sub> ≤ T <sub>amb</sub> ≤ T <sub>max</sub> MC35004B, MC33004B, MC34004B MC35004A, MC33004A, MC34004A		3 1	5 2		3 8		mV
DV <sub>IO</sub>	Input Offset Voltage Drift		10			10		μV/°C
I <sub>IO</sub>	Input Offset Current * T <sub>amb</sub> = 25 °C T <sub>min</sub> ≤ T <sub>amb</sub> ≤ T <sub>max</sub>		5	50 4		5 50 4		pA nA
I <sub>IB</sub>	Input Bias Current * T <sub>amb</sub> = 25 °C T <sub>min</sub> ≤ T <sub>amb</sub> ≤ T <sub>max</sub>		30	200 20		30 200 20		pA nA
A <sub>VD</sub>	Large Signal Voltage Gain (R <sub>L</sub> > 2 kΩ, V <sub>o</sub> = ± 10 V) T <sub>amb</sub> = 25 °C T <sub>min</sub> ≤ T <sub>amb</sub> ≤ T <sub>max</sub>	50 25	200		50 25	200		V/mV
SVR	Supply Voltage Rejection Ratio (R <sub>S</sub> < 10 kΩ) T <sub>amb</sub> = 25 °C T <sub>min</sub> ≤ T <sub>amb</sub> ≤ T <sub>max</sub>	80 80	86		80 80	86		dB
I <sub>CC</sub>	Supply Current, per Amp, no Load T <sub>amb</sub> = 25 °C T <sub>min</sub> ≤ T <sub>amb</sub> ≤ T <sub>max</sub>		1.4	2.5 2.5		1.4 2.5 2.5		mA
V <sub>I</sub>	Input Voltage Range T <sub>amb</sub> = 25 °C T <sub>min</sub> ≤ T <sub>amb</sub> ≤ T <sub>max</sub>	- 11		+ 11	- 11		+ 11	V
CMR	Common Mode Rejection Ratio (R <sub>S</sub> < 10 kΩ) T <sub>amb</sub> = 25 °C T <sub>min</sub> ≤ T <sub>amb</sub> ≤ T <sub>max</sub>	80 80	86		70 70	86		dB
I <sub>OS</sub>	Output Short-circuit Current T <sub>amb</sub> = 25 °C T <sub>min</sub> ≤ T <sub>amb</sub> ≤ T <sub>max</sub>	10 10	40	60 60	10 10	40 60 60		mA
± V <sub>OPP</sub>	Output Voltage Swing T <sub>amb</sub> = 25 °C R <sub>L</sub> ≥ 2 kΩ R <sub>L</sub> ≥ 10 kΩ T <sub>min</sub> ≤ T <sub>amb</sub> ≤ T <sub>max</sub> R <sub>L</sub> ≥ 2 kΩ R <sub>L</sub> ≥ 10 kΩ		11 12 12 11 12	12 13.5		11 12 11 12	12 13.5	V
S <sub>VO</sub>	Slew-rate (V <sub>I</sub> = 10 V, R <sub>L</sub> = 2 kΩ) C <sub>L</sub> ≤ 100 pF, T <sub>amb</sub> = 25 °C, unity gain	12	16		12	16		V/μs

\* The input bias currents are junction leakage currents which approximately double for every 10 °C increase in the junction temperature.

## ELECTRICAL CHARACTERISTICS (continued)

Symbol	Parameter	MC34004A, B MC33004A, B MC35004A, B			MC34004 MC33004 MC35004			Unit
		Min.	Typ.	Max.	Min.	Typ.	Max.	
$t_r$	Rise Time ( $V_I = 20$ mV, $R_L = 2$ k $\Omega$ ) $C_L = 100$ pF, $T_{amb} = 25$ °C, unity Gain		0.1			0.1		$\mu$ s
$K_{OV}$	Overshoot ( $V_I = 20$ mV, $R_L = 2$ k $\Omega$ ) $C_L \leq 100$ pF, $T_{amb} = 25$ °C, unity gain)		10			10		%
GBP	Gain Bandwidth Product ( $f = 100$ kHz, $T_{amb} = 25$ °C $V_{IN} = 10$ mV, $R_L = 2$ k $\Omega$ , $C_L = 100$ pF)	3.3	4.0	5.0	3.3	4.0	5.0	MHz
$R_I$	Input Resistance ( $T_{amb} = 25$ °C)		$10^{12}$			$10^{12}$		$\Omega$
THD	Total Harmonic Distortion ( $f = 1$ kHz, $A_V = 20$ dB, $R_L = 2$ k $\Omega$ ) $C_L \leq 100$ pF, $T_{amb} = 25$ °C, $V_O = 2$ V <sub>PP</sub> )		0.01			0.01		%
$V_n$	Equivalent Input Noise Voltage ( $f = 1$ kHz, $R_g = 100$ $\Omega$ )		15			15		nV/ $\sqrt{Hz}$
$\phi_m$	Phase Margin		45			45		Degrees
$V_{O1}/V_{O2}$	Channel Separation $A_{VD} = 100$ , $T_{amb} = 25$ °C		120					120

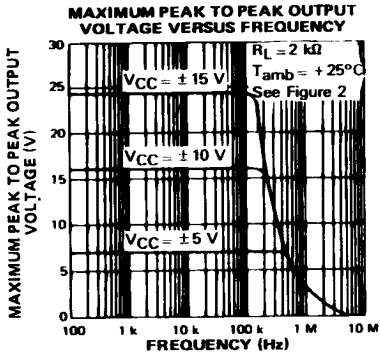

E88MC34004-02

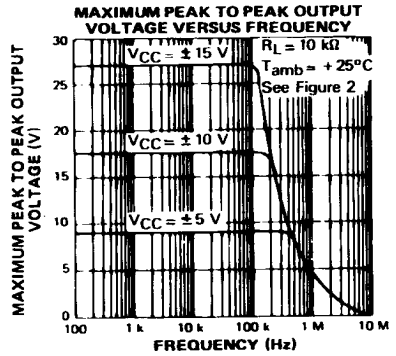

E88MC34004-03

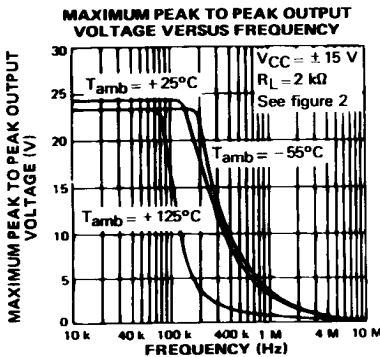

E88MC34004-04

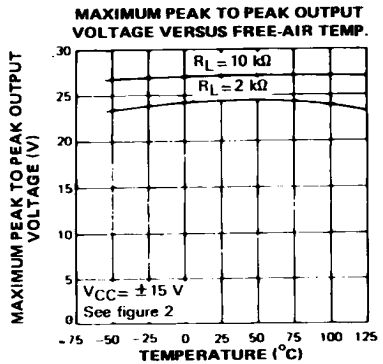

E88MC34004-05

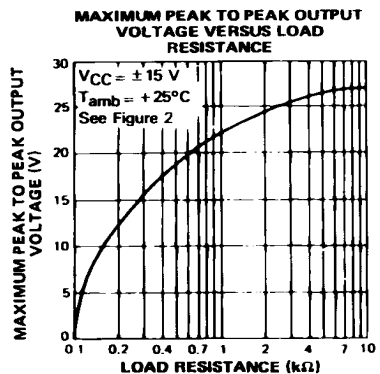

E88MC34004-06

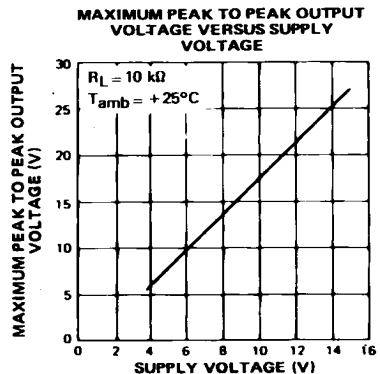

E88MC34004-07

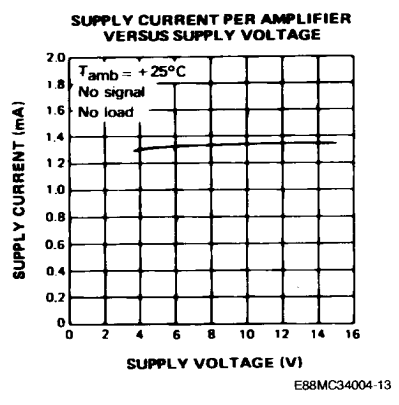
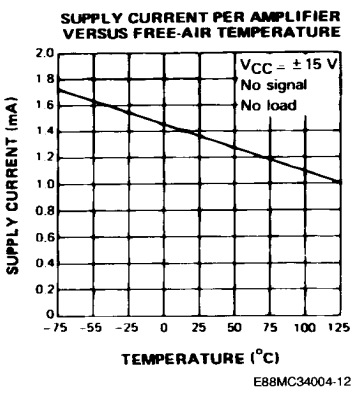
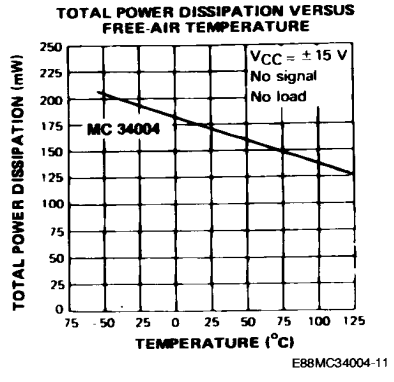
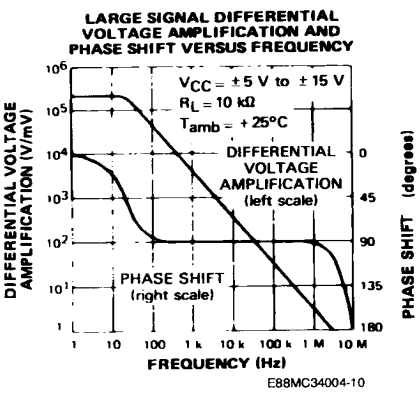
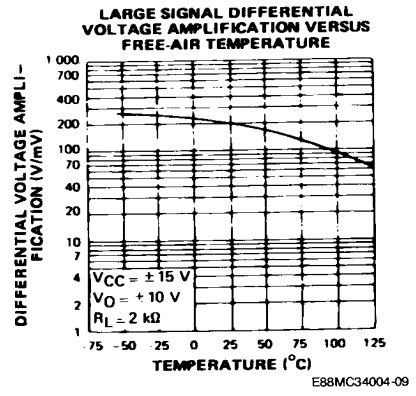
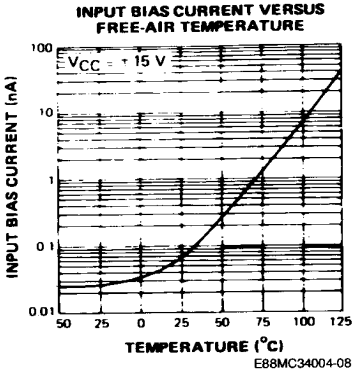

**COMMON MODE REJECTION RATIO  
VERSUS FREE-AIR TEMPERATURE**

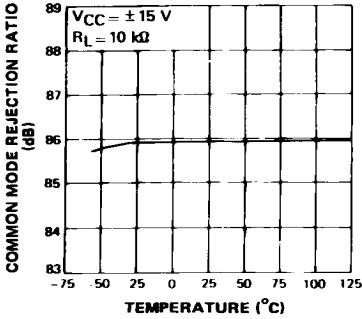

E88MC34004-14

**VOLTAGE FOLLOWER LARGE  
SIGNAL PULSE RESPONSE**

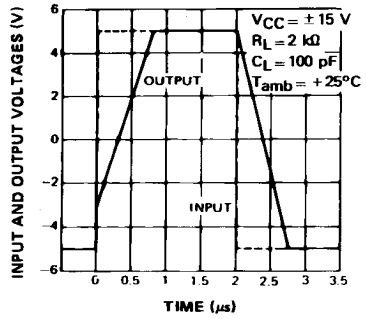

E88MC34004-15

**OUTPUT VOLTAGE VERSUS TIME**

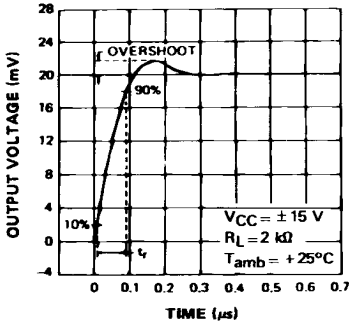

E88MC34004-16

**EQUIVALENT INPUT NOISE  
VOLTAGE VERSUS FREQUENCY**

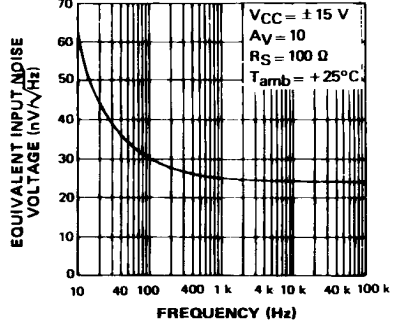

E88MC34004-17

**TOTAL HARMONIC DISTORTION  
VERSUS FREQUENCY**

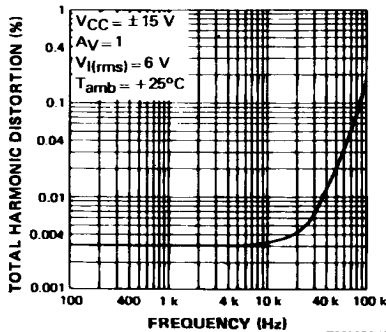

E88MC34004-18



PARAMETER MEASUREMENT INFORMATION

Figure 1 : Voltage Follower.

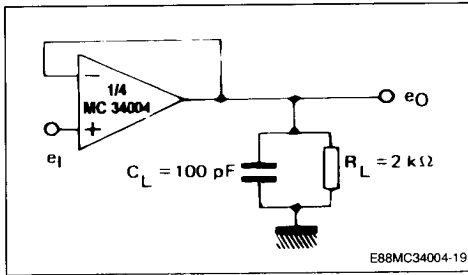
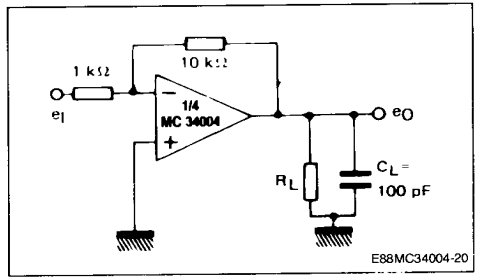
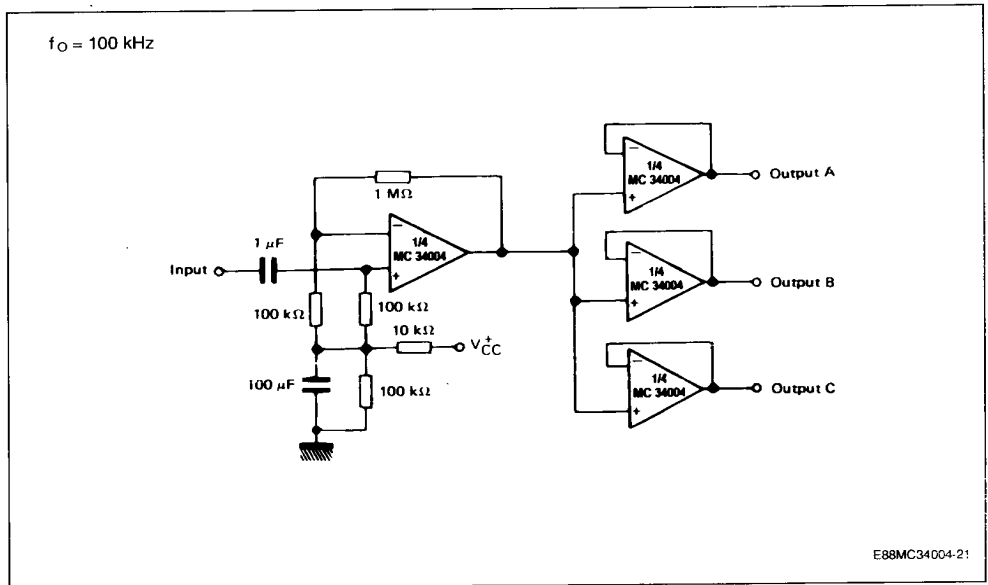

Figure 2 : Gain-of-10 Inverting Amplifier.



AUDIO DISTRIBUTION AMPLIFIER



TYPICAL APPLICATION

POSITIVE FEEDBACK BANDPASS FILTER

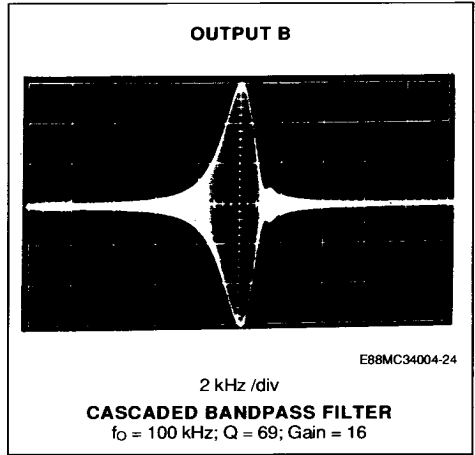
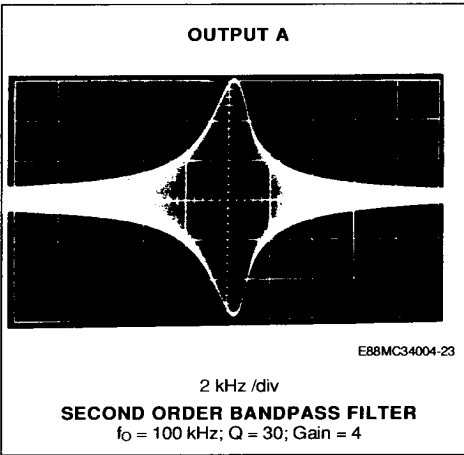
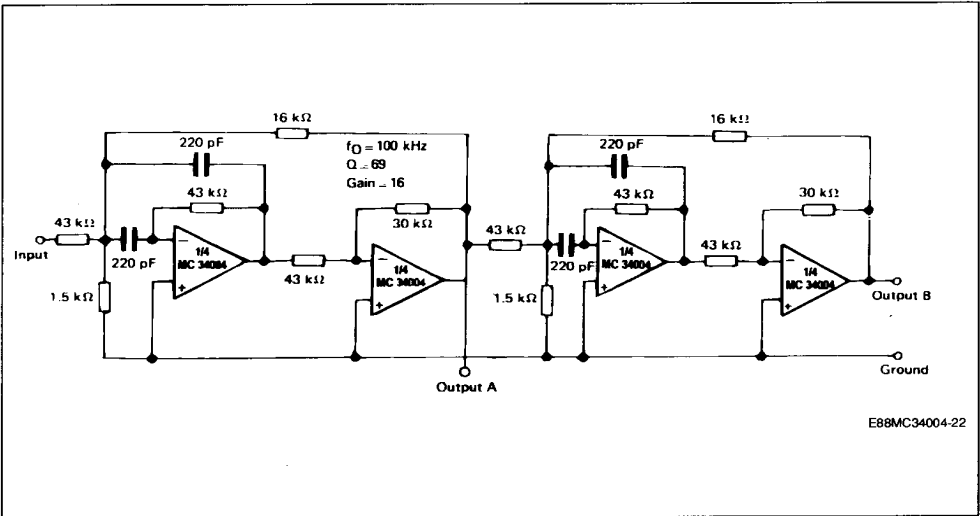

**PACKAGE MECHANICAL DATA**

**14 PINS – PLASTIC DIP OR CERDIP**

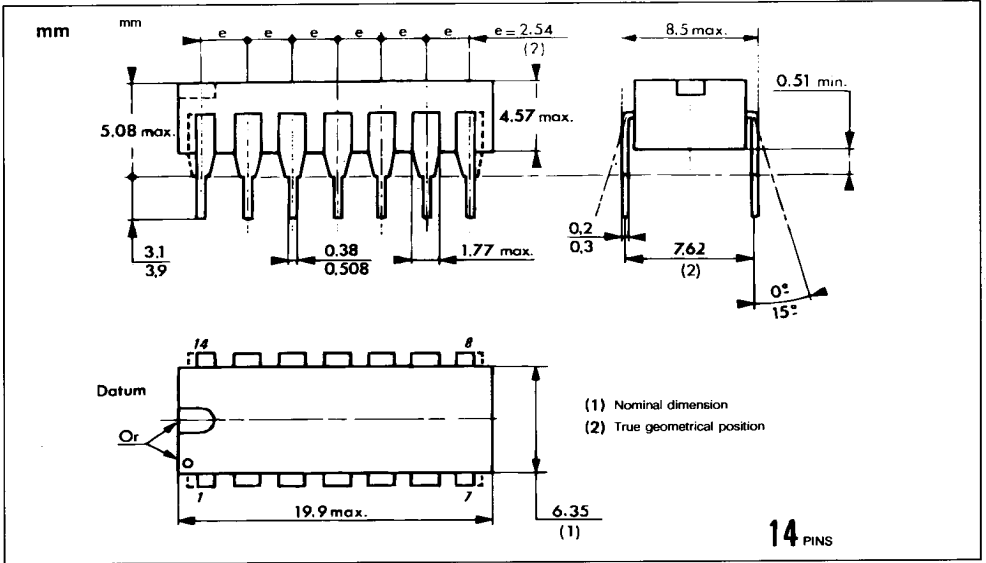

**14 PINS – PLASTIC MICROPACKAGE (SO)**

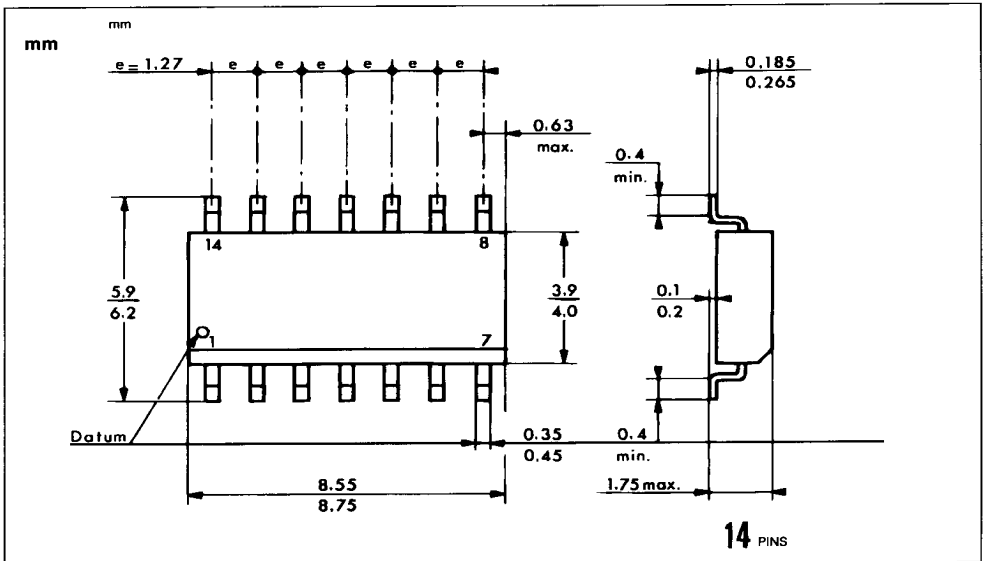

20 PINS - TRICECOP (LCC)

