



■ Features :

- DC/DC step-up converter
- Constant current output : 350mA to 1050mA
- Wide output LED string voltage up to 126VDC
- High efficiency up to 95%
- Built-in EMI filter ,comply with EN55015 without additional input filter and capacitors
- PWM + analog dimming and remote ON/OFF control
- Protections: Short circuit / Over voltage / Under voltage
- Cooling by free air convection
- Fully encapsulated
- 3 years warranty



LDH-45□-350○ □=A or B; A: 9~18VDC input range, B: 18~32VDC input range
○=Blank or W; Blank:pin style, W:wire style

SPECIFICATION

MODEL	LDH-45A-350○	LDH-45A-500○	LDH-45A-700○	LDH-45A-1050○	LDH-45B-350○	LDH-45B-500○	LDH-45B-700○	LDH-45B-1050○		
OUTPUT	RATED CURRENT		350mA	500mA	700mA	1050mA	350mA	500mA	700mA	1050mA
	CURRENT ACCURACY(Typ.)		±5% at 12VDC input				±5% at 24VDC input			
	VOLTAGE RANGE Note.3		12~86VDC	12~86VDC	12~64VDC	12~43VDC	21~126VDC	21~86VDC	21~64VDC	21~43VDC
	NO LOAD OUTPUT VOLTAGE(max.)		100V	100V	75V	50V	146V	100V	75V	50V
	RATED POWER		30.1W	43W	44.8W	45.15W	45.15W	43W	44.8W	45.15W
INPUT	RIPPLE & NOISE (max.) Note.2		2.5Vp-p	2.5Vp-p	1.9Vp-p	1.9Vp-p	2.5Vp-p	1.7Vp-p	1.2Vp-p	1.2Vp-p
	RATED VOLTAGE		12VDC				24VDC			
	VOLTAGE RANGE		9~18VDC				18~32VDC			
	EFFICIENCY (max.)		91%	90%	90%	91%	93%	94%	95%	95%
	DC CURRENT (Typ.)		2.8A	4.1A	4.2A	4.2A	2.1A	2.1A	2A	2A
PWM DIMMING & ON/OFF CONTROL	REMOTE ON/OFF		Leave open if not used							
			Power ON with dimming: PWM DIM~DIM- >2~8VDC or open circuit							
			Power OFF : PWM DIM~DIM- <0.5VDC or short or PWM duty is equal to 0%							
	PWM DIMMING FREQUENCY		1K~10KHz							
QUIESCENT INPUT CURRENT IN SHUTDOWN MODE(Typ.)		7mA at PWM dimming OFF								
ANALOG DIMMING & ON/OFF CONTROL	REMOTE ON/OFF		Leave open if not used							
			Power on with dimming: Analog DIM~DIM- >0.25~8VDC or open circuit							
			Power off : Analog DIM~DIM- <0.2VDC or short							
	DIM INPUT VOLTAGE RANGE		0.25~1.3VDC							
MAX OPERATION VOLTAGE		8V; The output current remains constant when voltage changes from 1.3V to 8V								
QUIESCENT INPUT CURRENT IN SHUTDOWN MODE(Typ.)		7mA at Analog dimming OFF								
PROTECTION	SHORT CIRCUIT		Protection type : Power OFF and fuse open							
	OVER VOLTAGE (max.)		100V	100V	75V	50V	146V	100V	75V	50V
		Protection type : Constant output voltage and shut off o/p current, recovers automatically after fault condition is removed								
ENVIRONMENT	WORKING TEMP.		-40 ~ +70°C (Refer to "Derating Curve")							
	WORKING HUMIDITY		20 ~ 90% RH non-condensing							
	STORAGE TEMP., HUMIDITY		-40 ~ +85°C, 10 ~ 95% RH							
	TEMP. COEFFICIENT		±0.03%/°C (0 ~ 50°C)							
	VIBRATION		10 ~ 500Hz, 2G 10min./1cycle, period for 60min. each along X, Y, Z axes							
SAFETY & EMC	SAFETY STANDARDS		EN61347-1, EN61347-2-13 approved							
	EMC EMISSION		Compliance to EN55015							
	EMC IMMUNITY		Compliance to EN61547,EN61000-4-2,3,4,6,8; light industry level, criteria A							
OTHERS	MTBF		1179.3Khrs min. MIL-HDBK-217F (25°C)							
	DIMENSION		75*53*22.7mm (L*W*H)							
	PACKING		138g;100pcs/14.8Kg/0.83CUFT(Blank Type),1.04CUFT(W Type)							
NOTE	<p>1. All parameters are specified at normal input(12VDC,24VDC), rated load, 25°C 70% RH ambient.</p> <p>2. Ripple & noise are measured at 20MHz of bandwidth by using a 12" twisted pair-wire terminated with a 0.1uf parallel capacitor.</p> <p>3. Output voltage will always step up by 3 Volts from input DC voltage.</p>									

■ Mechanical Specification

LDH (Pin Style):

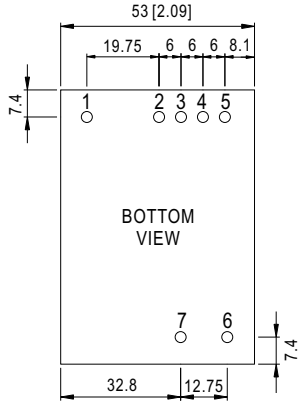

Unit: mm (inch)

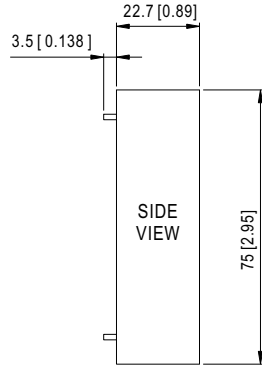

NOTE: Pin size tolerance $1.0 \phi \pm 0.05\text{mm}$

■ Pin Configuration

Pin No.		Comment
1	Vin+	DC Supply
2	Vin-	Don't connect to Vout-
3	DIM-	GND of DIM signal Don't connect to Vout- or Vin-
4	Analog DIM	ON/OFF and analog voltage dimming (leave open if not used)
5	PWM DIM	ON/OFF and PWM dimming (leave open if not used)
6	Vout-	LED - connection
7	Vout+	LED + connection

LDH (Wire Style):

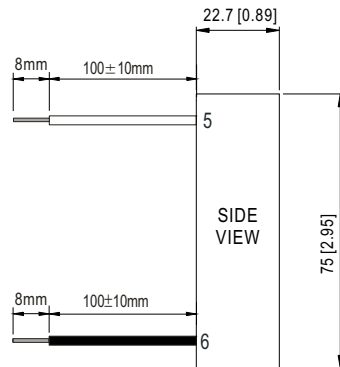
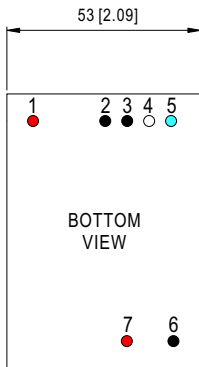

Pin No.		Comment
1	Vin+(red)	DC Supply
2	Vin-(black)	Don't connect to Vout-
3	DIM-(black)	GND of DIM signal Don't connect to Vout- or Vin-
4	Analog DIM (white)	ON/OFF and analog voltage dimming (leave open if not used)
5	PWM DIM (blue)	ON/OFF and PWM dimming (leave open if not used)
6	Vout-(black)	LED - connection
7	Vout+(red)	LED + connection

■ Derating Curve

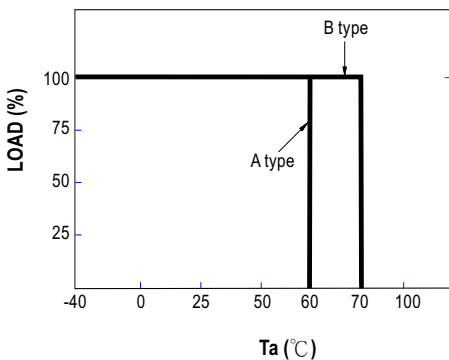

■ Static Characteristics

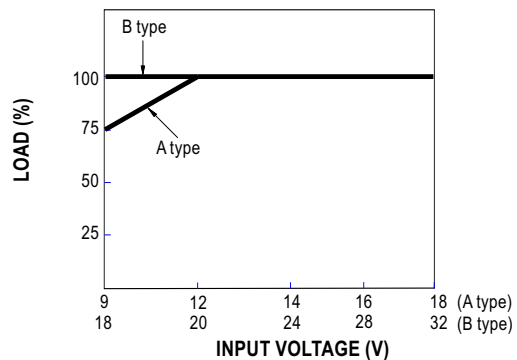

Standard Application

Operation without dimming:

I_O operates at rated current without dimming function when the pins of analog DIM and PWM DIM keep open

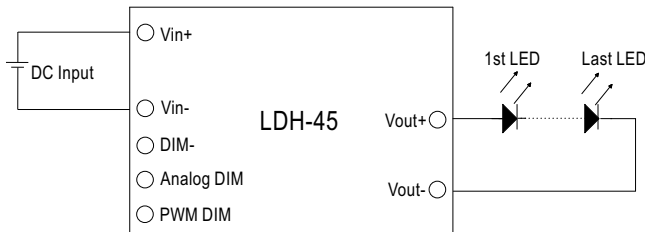

PWM Dimming Control:

I_O adjustment by PWM Signal

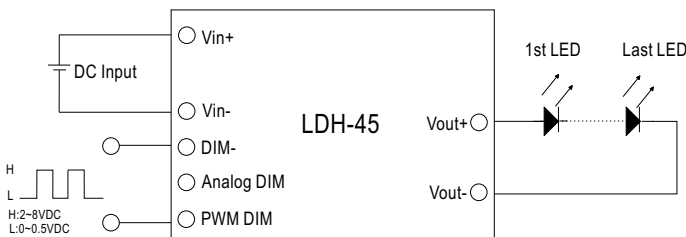

During PWM dimming operation, I_O will change with the PWM duty (PWM Signal: 1K~10KHz)

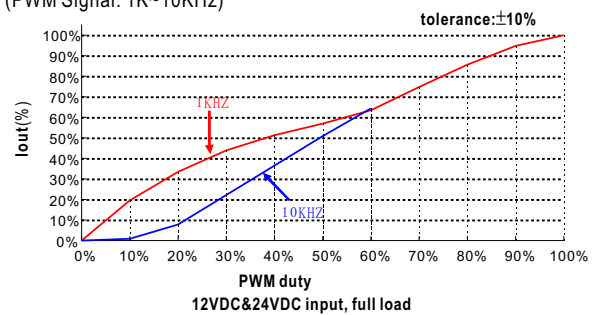

Analog Dimming Control:

I_O adjustment by DC voltage

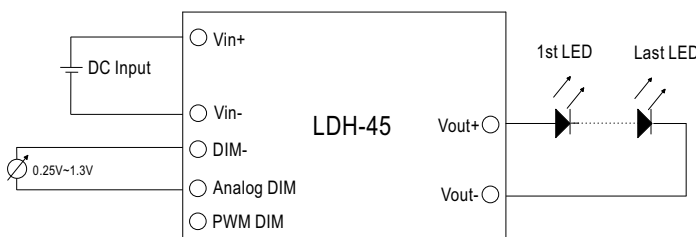

During analog dimming operation, I_O will change with DC input voltage

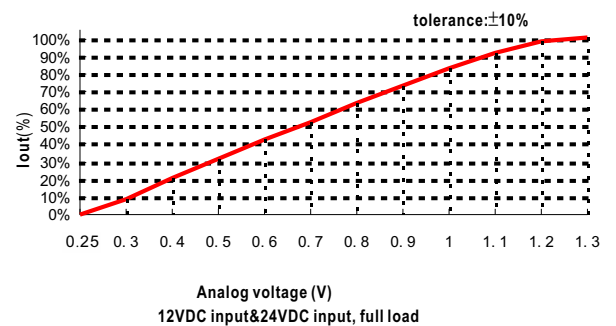

Application Notes:

1. The positive and negative input terminals must be connected correctly and negative voltage can not be input to avoid damage to the power supply.
2. Due to the large input current, please pay attention to the line voltage drop when wiring, to ensure the power supply to work properly.

■ Efficiency VS Output Voltage(Number of LEDs)

