PWM STEP-UP DC/DC CONVERTER
RH5RH××1A/××2B/××3B SERIES

APPLICATION MANUAL

RH5RH××1A/××2B/××3B SERIES

OUTLINE

The RH5RH××1A/××2B/××3B Series are PWM Step-up DC/DC converter ICs by CMOS process.

The RH5RH××1A IC consists of an oscillator, a PWM control circuit, a driver transistor (Lx switch), a reference voltage unit, an error amplifier, a phase compensation circuit, resistors for voltage detection, a soft-start circuit, and an Lx switch protection circuit. A low ripple, high efficiency step-up DC/DC converter can be constructed of this RH5RH××1A IC with only three external components, that is, an inductor, a diode and a capacitor.

These RH5RH××1A/××2B/××3B ICs can achieve ultra-low supply current (no load) –TYP. 15 μ A –by a newly developed PWM control circuit, equivalent to the low supply current of a VFM (chopper) Step-up DC/DC converter.

Furthermore, these ICs can hold down the supply current to TYP. 2 μ A by stopping the operation of the oscillator when the input voltage > (the output voltage set value + the dropout voltage by the diode and the inductor).

These RH5RH××1A/××2B/××3B Series ICs are recommendable to the user who desires a low ripple PWM DC/DC converter, but cannot adopt a conventional PWM DC/DC converter because of its too large supply current.

The RH5RH××2B/××3B Series ICs use the same chip as that employed in the RH5RH××1A IC and are provided with a drive pin (EXT) for an external transistor. Because of the use of the drive pin (EXT), an external transistor with a low saturation voltage can be used so that a large current can be caused to flow through the inductor and accordingly a large output current can be obtained. Therefore, these RH5RH××2B/××3B Series ICs are recommendable to the user who need a current as large as several tens mA to several hundreds mA.

The RH5RH××3B IC also includes an internal chip enable circuit so that it is possible to set the standby supply current at MAX. 0.5 μ A.

These RH5RH××1A/××2B/××3B ICs are suitable for use with battery-powered instruments with low noise and low supply current.

FEATURES

- Small Number of External ComponentsOnly an inductor, a diode and a capacitor (RH5RH××1A)
- Low Supply CurrentTYP. 15 μ A (RH5RH301A)
- Low Ripple and Low Noise
- Low Start-up Voltage (when the output current is 1mA)MAX. 0.9V
- High Output Voltage Accuracy $\pm 2.5\%$
- High EfficiencyTYP. 85%
- Low Temperature-Drift Coefficient of Output VoltageTYP. ± 50 ppm/ $^{\circ}$ C
- Soft-StartMIN. 500 μ s
- Small PackagesSOT-89 (RH5RH××1A, RH5RH××2B),
SOT-89-5 (RH5RH××3B)

APPLICATIONS

- Power source for battery-powered equipment.
- Power source for cameras, camcorders, VCRs, PDAs, electronic data banks, and hand-held communication equipment.
- Power source for instruments which require low noise and low supply current, such as hand-held audio equipment.
- Power source for appliances which require higher cell voltage than that of batteries used in the appliances.

BLOCK DIAGRAM

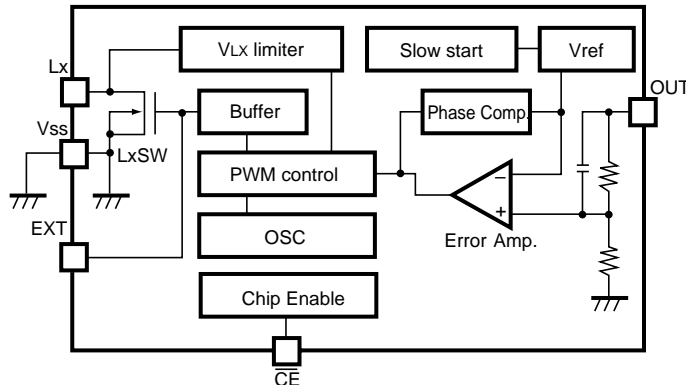

Error Amp. (Error Amplifier) has a DC gain of 80dB, and Phase Comp. (Phase Compensation Circuit) provides the frequency characteristics including the 1st pole ($f_p=0.25\text{Hz}$) and the zero point ($f_z=2.5\text{kHz}$). Furthermore, another zero point ($f_z=1.0\text{kHz}$) is also obtained by the resistors and a capacitor connected to the OUT pin.

(Note) Lx Pinonly for RH5RH××1A and RH5RH××3B
 EXT Pinonly for RH5RH××2B and RH5RH××3B
 CE Pinonly for RH5RH××3B

SELECTION GUIDE

In RH5RH Series, the output voltage, the driver, and the taping type for the ICs can be selected at the user's request. The selection can be made by designating the part number as shown below :

RH5RH×××× - ×× ← Part Number
 ↑ ↑ ↑
 a b c

Code	Description
a	Setting Output Voltage (VOUT): Stepwise setting with a step of 0.1V in the range of 2.7V to 7.5V is possible.
b	Designation of Driver: 1A: Internal Lx Tr. Driver (Oscillator Frequency 50kHz) 2B: External Tr. Driver (Oscillator Frequency 100kHz) 3B: Internal Tr./External Tr. (selectively available) (Oscillator Frequency 100kHz, with chip enable function)
c	Designation of Taping Type : Ex. SOT-89 : T1, T2 SOT-89-5 : T1, T2 (refer to Taping Specifications) "T1" is prescribed as a standard.

For example, the product with Output Voltage 5.0V, the External Driver (the Oscillator Frequency 100kHz) and Taping Type T1, is designated by Part Number RH5RH502B-T1.

PIN CONFIGURATION

• SOT-89

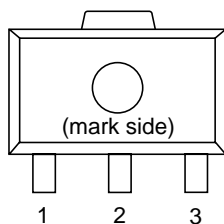

• SOT-89-5

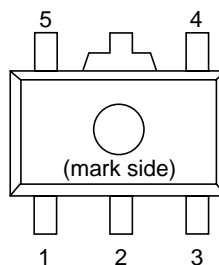

PIN DESCRIPTION

Pin No.			Symbol	Description
××1B	××2B	××3B		
1	1	5	VSS	Ground Pin
2	2	2	OUT	Step-up Output Pin, Power Supply (for device itself)
3	—	4	Lx	Switching Pin (Nch Open Drain)
—	3	3	EXT	External Tr. Drive Pin (CMOS Output)
—	—	1	$\overline{\text{CE}}$	Chip Enable Pin (Active Low)

ABSOLUTE MAXIMUM RATINGS

V_{SS}=0V

Symbol	Item	Rating	Unit	Note
V _{OUT}	Output Pin Voltage	+12	V	
V _{LX}	Lx Pin Voltage	+12	V	Note1
V _{EXT}	EXT Pin Voltage	-0.3 to V _{OUT} +0.3	V	Note2
V _{CE}	$\overline{\text{CE}}$ Pin Voltage	-0.3 to V _{OUT} +0.3	V	Note3
I _{LX}	Lx Pin Output Current	250	mA	Note1
I _{EXT}	EXT Pin Current	±50	mA	Note2
P _D	Power Dissipation	500	mW	
T _{opt}	Operating Temperature Range	-30 to +80	°C	
T _{stg}	Storage Temperature Range	-55 to +125	°C	
T _{solder}	Lead Temperature(Soldering)	260°C,10s		

(Note 1) Applicable to RH5RH××1A and RH5RH××3B. (Note 2) Applicable to RH5RH××2B and RH5RH××3B.

(Note 3) Applicable to RH5RH××3B.

ABSOLUTE MAXIMUM RATINGS

Absolute Maximum ratings are threshold limit values that must not be exceeded even for an instant under any conditions. Moreover, such values for any two items must not be reached simultaneously. Operation above these absolute maximum ratings may cause degradation or permanent damage to the device. These are stress ratings only and do not necessarily imply functional operation below these limits.

ELECTRICAL CHARACTERISTICS

• RH5RH301A

 $V_{OUT}=3.0V$

Symbol	Item	Conditions	MIN.	TYP.	MAX.	Unit	Note
V_{OUT}	Output Voltage		2.925	3.000	3.075	V	
V_{IN}	Input Voltage				8	V	
V_{start}	Start-up Voltage	$I_{OUT}=1mA, V_{IN} : 0 \rightarrow 2V$		0.8	0.9	V	
V_{hold}	Hold-on Voltage	$I_{OUT}=1mA, V_{IN} : 2 \rightarrow 0V$	0.7			V	
I_{DD1}	Supply Current 1	To be measured at OUT Pin (excluding Switching Current)		15	25	μA	
I_{DD2}	Supply Current 2	To be measured at OUT Pin (excluding Switching Current) $V_{IN}=3.5V$		2	5	μA	
I_{LX}	Lx Switching Current	$V_{LX}=0.4V$	60			mA	
I_{LXleak}	Lx Leakage Current	$V_{LX}=6V, V_{IN}=3.5V$			0.5	μA	
f_{osc}	Oscillator Frequency		40	50	60	kHz	
Maxdty	Oscillator Maximum Duty Cycle	on (V_{LX} "L") side	70	80	90	%	
η	Efficiency		70	85		%	
t_{start}	Soft-Start Time	Time required for the rising of V_{OUT} up to 3V.	0.5	2.0		ms	Note1
V_{LXlim}	V_{LX} Voltage Limit	Lx Switch ON	0.65	0.8	1.0	V	Note2

Unless otherwise provided, $V_{IN}=1.8V$, $V_{SS}=0V$, $I_{OUT}=10mA$, $T_{opt}=25^{\circ}C$, and use External Circuit of Typical Application (FIG. 1).

(Note 1) Soft-Start Circuit is operated in the following sequence :

- (1) V_{IN} is applied.
- (2) The voltage (V_{ref}) of the reference voltage unit is maintained at 0V for about 200 μs after the application of V_{IN} .
- (3) The output of Error Amp. is raised to "H" level during the maintenance of the voltage (V_{ref}) of the reference voltage unit.
- (4) After the rise of V_{ref} , the output of Internal Error Amp. is gradually decreased to an appropriate value by the function of Internal Phase Compensation Circuit, and the Output Voltage is gradually increased in accordance with the gradual decrease of the output of Internal Error Amp.

(Note 2) I_{LX} is gradually increased after Lx Switch is turned ON. In accordance with the increase of I_{LX} , V_{LX} is also increased. When V_{LX} reaches V_{LXlim} , Lx Switch is turned OFF by an Lx Switch Protection Circuit.

• RH5RH501A

V_{OUT}=5.0V

Symbol	Item	Conditions	MIN.	TYP.	MAX.	Unit	Note
V _{OUT}	Output Voltage		4.875	5.000	5.125	V	
V _{IN}	Input Voltage				8	V	
V _{start}	Start-up Voltage	I _{out} =1mA, V _{in} :0→2V		0.8	0.9	V	
V _{hold}	Hold-on Voltage	I _{out} =1mA, V _{in} :2→0V	0.7			V	
I _{DD1}	Supply Current 1	To be measured at OUT Pin (excluding Switching Current)		30	45	μA	
I _{DD2}	Supply Current 2	To be measured at OUT Pin (excluding Switching Current) V _{IN} =5.5V		2	5	μA	
I _{LX}	Lx Switching Current	V _{LX} =0.4V	80			mA	
I _{LXleak}	Lx Leakage Current	V _{LX} =6V, V _{IN} =5.5V			0.5	μA	
f _{osc}	Oscillator Frequency		40	50	60	kHz	
Maxdty	Oscillator Maximum Duty Cycle	on (V _{LX} "L") side	70	80	90	%	
η	Efficiency		70	85		%	
t _{start}	Soft-Start Time	Time required for the rising of V _{OUT} up to 5V.	0.5	2.0		ms	Note1
V _{LXlim}	V _{LX} Voltage Limit	Lx Switch ON	0.65	0.8	1.0	V	Note2

Unless otherwise provided, V_{IN}=3V, V_{SS}=0V, I_{OUT}=10mA, T_{opt}=25°C, and use External Circuit of Typical Application (FIG. 1).

(Note 1) Soft-Start Circuit is operated in the following sequence :

- (1) V_{IN} is applied.
- (2) The voltage (V_{ref}) of the reference voltage unit is maintained at 0V for about 200μs after the application of V_{IN}.
- (3) The output of Error Amp. is raised to "H" level during the maintenance of the voltage (V_{ref}) of the reference voltage unit.
- (4) After the rise of V_{ref}, the output of Internal Error Amp. is gradually decreased to an appropriate value by the function of Internal Phase Compensation Circuit, and the Output Voltage is gradually increased in accordance with the gradual decrease of the output of Internal Error Amp.

(Note 2) I_{LX} is gradually increased after Lx Switch is turned ON. In accordance with the increase of I_{LX}, V_{LX} is also increased. When V_{LX} reaches V_{LXlim}, Lx Switch is turned OFF by an Lx Switch Protection Circuit.

• RH5RH302B

V_{OUT}=3.0V

Symbol	Item	Conditions	MIN.	TYP.	MAX.	Unit	Note
V _{OUT}	Output Voltage		2.925	3.000	3.075	V	
V _{IN}	Input Voltage				8	V	
V _{start}	Oscillator Start-up Voltage	EXT no load, V _{OUT} : 0→2V		0.7	0.8	V	
I _{DD1}	Supply Current 1	EXT no load, V _{OUT} =2.88V		30	50	μA	
I _{DD2}	Supply Current 2	EXT no load, V _{OUT} =3.5V		2	5	μA	
I _{EXTH}	EXT “H” Output Current	V _{EXT} =V _{OUT} -0.4V			-1.5	mA	
I _{EXTL}	EXT “L” Output Current	V _{EXT} =0.4V	1.5			mA	
f _{osc}	Oscillator Frequency		80	100	120	kHz	
Maxdty	Oscillator Maximum Duty Cycle	V _{EXT} “H” side	70	80	90	%	
t _{start}	Soft-Start Time	Time required for the rising of V _{OUT} up to 3V	0.5	2.0		ms	Note1

Unless otherwise provided, V_{IN}=1.8V, V_{SS}=0V, I_{OUT}=10mA, T_{opt}=25°C, and use External Circuit of Typical Application (FIG. 2).

• RH5RH502B

V_{OUT}=5.0V

Symbol	Item	Conditions	MIN.	TYP.	MAX.	Unit	Note
V _{OUT}	Output Voltage		4.875	5.000	5.125	V	
V _{IN}	Input Voltage				8	V	
V _{start}	Oscillator Start-up Voltage	EXT no load, V _{OUT} : 0→2V		0.7	0.8	V	
I _{DD1}	Supply Current 1	EXT no load, V _{OUT} =4.8V		60	90	μA	
I _{DD2}	Supply Current 2	EXT no load, V _{OUT} =5.5V		2	5	μA	
I _{EXTH}	EXT “H” Output Current	V _{EXT} =V _{OUT} -0.4V			-2	mA	
I _{EXTL}	EXT “L” Output Current	V _{EXT} =0.4V	2			mA	
f _{osc}	Oscillator Frequency		80	100	120	kHz	
Maxdty	Oscillator Maximum Duty Cycle	V _{EXT} “H” side	70	80	90	%	
t _{start}	Soft-Start Time	Time required for the rising of V _{OUT} up to 5V	0.5	2.0		ms	Note1

Unless otherwise provided, V_{IN}=3V, V_{SS}=0V, I_{OUT}=10mA, T_{opt}=25°C and use External Circuit of Typical Application (FIG. 2).

■ (Note 1) refer to page 5 (Note 1)

• RH5RH303B

V_{OUT}=3.0V

Symbol	Item	Conditions	MIN.	TYP.	MAX.	Unit	Note
V _{OUT}	Output Voltage		2.925	3.000	3.075	V	
V _{IN}	Input Voltage				8	V	
V _{start}	Start-up Voltage	I _{OUT} =1mA, V _{IN} : 0→2V		0.8	0.9	V	
V _{hold}	Hold-on Voltage	I _{OUT} =1mA, V _{IN} : 2→0V	0.7			V	
η	Efficiency		70	85		%	
I _{DD1}	Supply Current 1	To be measured at OUT pin		30	50	μA	
I _{DD2}	Supply Current 2	To be measured at OUT pin V _{IN} =3.5V		2	5	μA	
I _{LX}	Lx Switching Current	V _{LX} =0.4V	60			mA	
I _{LXleak}	Lx Leakage Current	V _{LX} =6V, V _{IN} =3.5V			0.5	μA	
I _{EXTH}	EXT “H” Output Current	V _{EXT} =V _{OUT} -0.4V			-1.5	mA	
I _{EXTL}	EXT “L” Output Current	V _{EXT} =0.4V	1.5			mA	
V _{CEH1}	\overline{CE} “H” Level 1	V _{OUT} ≥1.5V	V _{OUT} -0.4			V	
V _{CEL1}	\overline{CE} “L” Level 1	V _{OUT} ≥1.5V			0.4	V	
V _{CEH2}	\overline{CE} “H” Level 2	0.8V≤V _{OUT} <1.5V	V _{OUT} -0.1			V	
V _{CEL2}	\overline{CE} “L” Level 2	0.8V≤V _{OUT} <1.5V			0.1	V	
I _{CEH}	\overline{CE} “H” Input Current	\overline{CE} =3V			0.5	μA	
I _{CEL}	\overline{CE} “L” Input Current	\overline{CE} =0V	-0.5			μA	
f _{osc}	Oscillator Frequency		80	100	120	kHz	
Maxdty	Oscillator Maximum Duty Cycle	on (V _{LX} “L”)side	70	80	90	%	
t _{start}	Soft-Start Time	Time required for the rising of V _{OUT} up to 3V.	0.5	2.0		ms	Note1
V _{LXlim}	V _{LX} Voltage Limit	Lx Switch ON	0.65	0.8	1.0	V	Note2

Unless otherwise provided, V_{IN}=1.8V, V_{SS}=0V, I_{OUT}=10mA, T_{opt}=25°C, and use External Circuit of Typical Application (FIG. 3).

(Note 1) Soft-Start Circuit is operated in the following sequence :

- (1) V_{IN} is applied.
- (2) The voltage (V_{ref}) of the reference voltage unit is maintained at 0V for about 200μs after the application of V_{IN}.
- (3) The output of Error Amp. is raised to “H” level during the maintenance of the voltage (V_{ref}) of the reference voltage unit.
- (4) After the rise of V_{ref}, the output of Internal Error Amp. is gradually decreased to an appropriate value by the function of Internal Phase Compensation Circuit, and the Output Voltage is gradually increased in accordance with the gradual decrease of the output of Internal Error Amp.

(Note 2) I_{LX} is gradually increased after Lx Switch is turned ON. In accordance with the increase of I_{LX}, V_{LX} is also increased. When V_{LX} reaches V_{LXlim}, Lx Switch is turned OFF by an Lx Switch Protection Circuit.

• RH5RH503B

V_{OUT}=5.0V

Symbol	Item	Conditions	MIN.	TYP.	MAX.	Unit	Note
V _{OUT}	Output Voltage		4.875	5.000	5.125	V	
V _{IN}	Input Voltage				8	V	
V _{start}	Start-up Voltage	I _{OUT} =1mA, V _{IN} : 0→2V		0.8	0.9	V	
V _{hold}	Hold-on Voltage	I _{OUT} =1mA, V _{IN} : 2→0V	0.7			V	
η	Efficiency		70	85		%	
I _{DD1}	Supply Current 1	To be measured at OUT pin		60	90	μA	
I _{DD2}	Supply Current 2	To be measured at OUT pin V _{IN} =5.5V		2	5	μA	
I _{LX}	Lx Switching Current	V _{LX} =0.4V	80			mA	
I _{LXleak}	Lx Leakage Current	V _{LX} =6V, V _{IN} =5.5V			0.5	μA	
I _{EXTH}	EXT “H” Output Current	V _{EXT} =V _{OUT} -0.4V			-2.0	mA	
I _{EXTL}	EXT “L” Output Current	V _{EXT} =0.4V	2.0			mA	
V _{CEH1}	$\overline{\text{CE}}$ “H” Level 1	V _{OUT} ≥1.5V	V _{OUT} -0.4			V	
V _{CEL1}	$\overline{\text{CE}}$ “L” Level 1	V _{OUT} ≥1.5V			0.4	V	
V _{CEH2}	$\overline{\text{CE}}$ “H” Level 2	0.8V≤V _{OUT} <1.5V	V _{OUT} -0.1			V	
V _{CEL2}	$\overline{\text{CE}}$ “L” Level 2	0.8V≤V _{OUT} <1.5V			0.1	V	
I _{CEH}	$\overline{\text{CE}}$ “H” Input Current	$\overline{\text{CE}}$ =5V			0.5	μA	
I _{CEL}	$\overline{\text{CE}}$ “L” Input Current	$\overline{\text{CE}}$ =0V	-0.5			μA	
f _{osc}	Oscillator Frequency		80	100	120	kHz	
Maxdty	Oscillator Maximum Duty Cycle	on (V _{LX} “L”)side	70	80	90	%	
t _{start}	Soft-Start Time	Time required for the rising of V _{OUT} up to 5V.	0.5	2.0		ms	Note1
V _{LXlim}	V _{LX} Voltage Limit	Lx Switch ON	0.65	0.8	1.0	V	Note2

Unless otherwise provided, V_{IN}=3V, V_{SS}=0V, I_{OUT}=10mA, T_{opt}=25°C, and use External Circuit of Typical Application (FIG. 3).

(Note 1) Soft-Start Circuit is operated in the following sequence :

- (1) V_{IN} is applied.
- (2) The voltage (V_{ref}) of the reference voltage unit is maintained at 0V for about 200μs after the application of V_{IN}.
- (3) The output of Error Amp. is raised to “H” level during the maintenance of the voltage (V_{ref}) of the reference voltage unit.
- (4) After the rise of V_{ref}, the output of Internal Error Amp. is gradually decreased to an appropriate value by the function of Internal Phase Compensation Circuit, and the Output Voltage is gradually increased in accordance with the gradual decrease of the output of Internal Error Amp.

(Note 2) I_{LX} is gradually increased after Lx Switch is turned ON. In accordance with the increase of I_{LX}, V_{LX} is also increased. When V_{LX} reaches V_{LXlim}, Lx Switch is turned OFF by an Lx Switch Protection Circuit.

OPERATION OF STEP-UP DC/DC CONVERTER

Step-up DC/DC Converter charges energy in the inductor when Lx Transistor (LxTr) is on, and discharges the energy with the addition of the energy from Input Power Source thereto, so that a higher output voltage than the input voltage is obtained.

The operation will be explained with reference to the following diagrams :

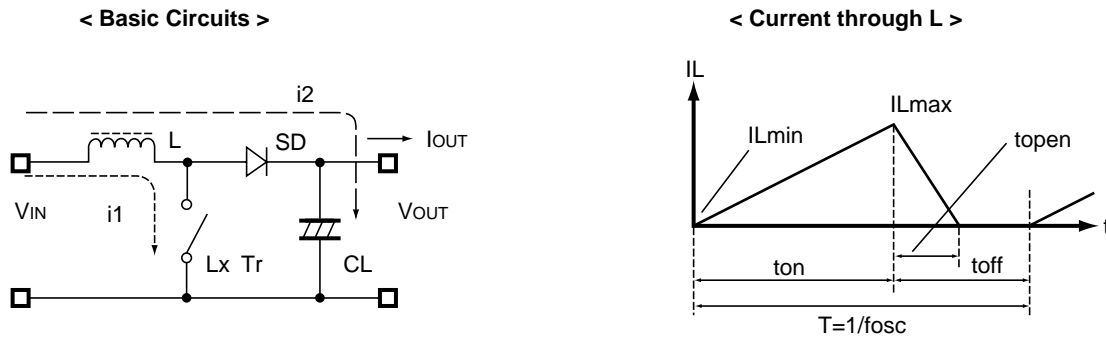

Step 1 : LxTr is turned ON and current IL (= i1) flows, so that energy is charged in L. At this moment, IL(=i1) is increased from ILmin (= 0) to reach ILmax in proportion to the on-time period (ton) of LxTr.

Step 2 : When LxTr is turned OFF, Schottky diode (SD) is turned ON in order that L maintains IL at ILmax, so that current IL (= i2) is released.

Step 3 : IL (=i2) is gradually decreased, and in the case of discontinuous mode, IL reaches ILmin (=0) after a time period of topen, so that SD is turned OFF. However, in the case of a continuous mode which will be mentioned later, the time period (toff) runs out before IL reaches ILmin (=0), so that LxTr is turned ON in the next cycle, and SD is turned OFF. In this case, ILmin does not reach zero, and IL (=i1) increases from ILmin (> 0).

In the case of PWM control system, the output voltage is maintained constant by controlling the on-time period (ton), with the oscillator frequency (fosc) being maintained constant.

• Discontinuous Conduction Mode and Continuous Conduction Mode

In the above two diagrams, the maximum value (ILmax) and the minimum value (ILmin) of the current which flows through the inductor are the same as those when LxTr is ON and also when LxTr is OFF.

The difference between ILmax and ILmin, which is represented by ΔI, is :

$$\Delta I = I_{Lmax} - I_{Lmin} = V_{IN} \cdot t_{on} / L = (V_{OUT} - V_{IN}) \cdot t_{open} / L \dots \dots \dots \text{Equation 1}$$

wherein $T = 1/f_{osc} = t_{on} + t_{off}$
 duty (%) = $t_{on} / T \cdot 100 = t_{on} \cdot f_{osc} \cdot 100$
 $t_{open} \leq t_{off}$

In Equation 1, $V_{IN} \cdot t_{on} / L$ and $(V_{OUT} - V_{IN}) \cdot t_{open} / L$ are respectively show the change in the current at ON, and the change in the current at OFF.

When the output current (I_{OUT}) is relatively small, $t_{open} < t_{off}$ as illustrated in the above diagram. In this case, the energy charged in the inductor during the time period of t_{on} is discharged in its entirety during the time period of t_{off} , so that I_{Lmin} becomes zero ($I_{Lmin}=0$). When I_{OUT} is gradually increased, t_{open} eventually becomes equal to t_{off} ($t_{open}=t_{off}$), and when I_{OUT} is further increased, I_{Lmin} becomes larger than zero ($I_{Lmin}>0$). The former mode is referred to as the discontinuous mode and the latter mode is referred to as the continuous mode.

In the continuous mode, when Equation 1 is solved for t_{on} and the solution is t_{onc} ,

$$t_{onc} = T \cdot (1 - V_{IN}/V_{OUT}) \dots\dots\dots \text{Equation 2}$$

When $t_{on} < t_{onc}$, the mode is the discontinuous mode, and when $t_{on} = t_{onc}$, the mode is the continuous mode.

• Output Current in Discontinuous Mode

In the discontinuous mode, when $LxTr$ is on, the energy P_{ON} charged in the inductor is provided by Equation 3 as follows :

$$\begin{aligned} P_{ON} &= \int_0^{t_{on}} V_{IN} \cdot I_L(t) dt = \int_0^{t_{on}} (V_{IN}^2 \cdot t/L) dt \\ &= V_{IN}^2 \cdot t_{on}^2 / (2 \cdot L) \dots\dots\dots \text{Equation 3} \end{aligned}$$

In the case of the step-up DC/DC converter, the energy is also supplied from the input power source at the time of OFF.

$$\begin{aligned} \text{Thus, } P_{OFF} &= \int_0^{t_{open}} V_{IN} \cdot I_L(t) dt = \int_0^{t_{open}} ((V_{OUT} - V_{IN}) \cdot t/L) dt \\ &= V_{IN} \cdot (V_{OUT} - V_{IN}) \cdot t_{open}^2 / (2 \cdot L) \end{aligned}$$

Here, $t_{open} = V_{IN} \cdot t_{on} / (V_{OUT} - V_{IN})$ from Equation 1, and when this is substituted into the above equation.

$$= V_{IN}^3 \cdot t_{on}^2 / (2 \cdot L \cdot (V_{OUT} - V_{IN})) \dots\dots\dots \text{Equation 4}$$

Input power is $(P_{ON} + P_{OFF})/T$. When this is converted in its entirety to the output.

$$P_{IN} = (P_{ON} + P_{OFF})/T = V_{OUT} \cdot I_{OUT} = P_{OUT} \dots\dots\dots \text{Equation 5}$$

Equation 6 can be obtained as follows by solving Equation 5 for I_{OUT} by substituting Equations 3 and 4 into Equation 5 :

$$I_{OUT} = V_{IN}^2 \cdot t_{on}^2 / (2 \cdot L \cdot T \cdot (V_{OUT} - V_{IN})) \dots\dots\dots \text{Equation 6}$$

The peak current which flows through $L \cdot LxTr \cdot SD$ is

$$I_{Lmax} = V_{IN} \cdot t_{on} / L \dots\dots\dots \text{Equation 7}$$

Therefore it is necessary that the setting of the input/output conditions and the selection of peripheral components should be made with I_{Lmax} taken into consideration.

• Output Current in Continuous Conduction Mode

When the operation enters into the continuous conduction mode by increasing the I_{OUT} , I_{Lmin} becomes equal to I_{const} (> 0), and this current always flows through the inductor. Therefore, $V_{IN} \cdot I_{const}$ is added to P_{IN} in Equation 5.

$$\text{Thus, } P_{IN} = V_{IN} \cdot I_{const} + (P_{ON} + P_{OFF})/T = V_{OUT} \cdot I_{OUT} = P_{OUT}$$

When the above Equation is solved for I_{OUT} ,

$$I_{OUT} = V_{IN}^2 \cdot \text{tonc}^2 / (2 \cdot L \cdot T \cdot (V_{OUT} - V_{IN})) + V_{IN} \cdot I_{const} / V_{OUT} \dots\dots\dots \text{Equation 8}$$

The peak current which flows through $L \cdot L_{xTr} \cdot SD$ is

$$I_{Lmax} = V_{IN} \cdot \text{ton} / L + I_{const} \dots\dots\dots \text{Equation 9}$$

From Equations 6 and 9, the larger the value of L , the smaller the load current at which the operation enters into the continuous mode, and the smaller the difference between I_{Lmax} and I_{Lmin} , and the smaller the value of I_{Lmax} .

Therefore, when the load current is the same, the larger the value of L , the easier the selection of peripheral components with a small allowable current becomes, and the smaller the ripple of the peripheral components can be made. In this case, however, it must be noted from Equation 6 that I_{OUT} becomes small when the allowable current of the inductor is small or when V_{IN} is so small that the operation cannot enter into the continuous mode.

HINTS

The above explanation is directed to the calculation in an ideal case where there is no energy loss caused by the resistance in the external components and L_{xSW} . In an actual case, the maximum output current will be 50 to 80% of the above calculated maximum output current. In particular, care must be taken because V_{IN} is decreased in an amount corresponding to the voltage drop caused by L_{xSW} when I_L is large or V_{IN} is low. Furthermore, it is required that with respect to V_{OUT} , V_f of the diode (about 0.3V in the case of a Schottky type diode) be taken into consideration.

TYPICAL CHARACTERISTICS

1) Output Voltage vs. Output Current

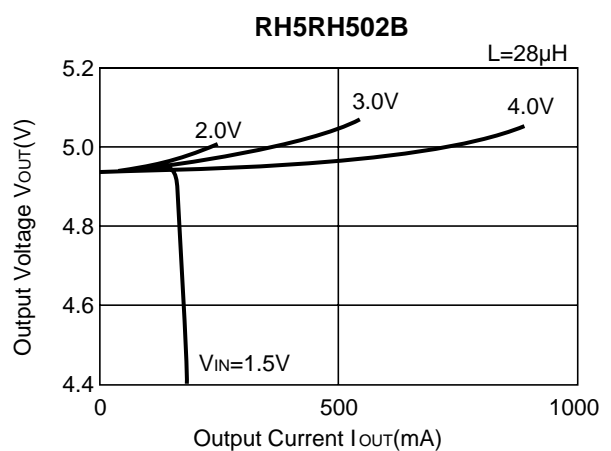
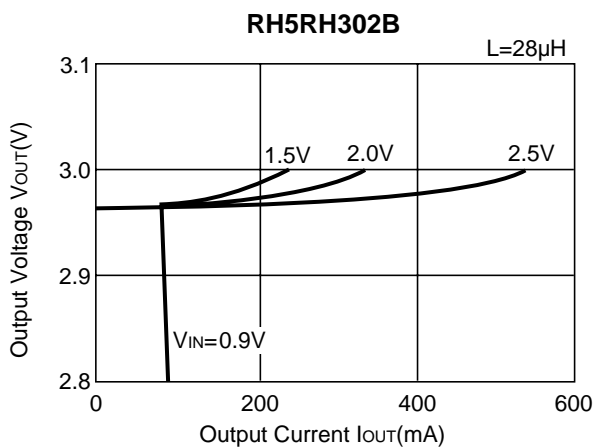
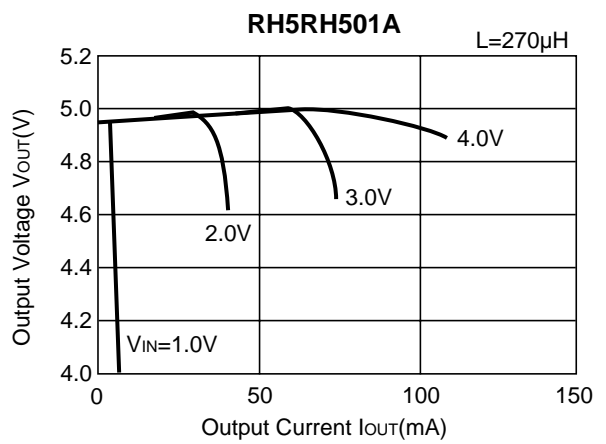
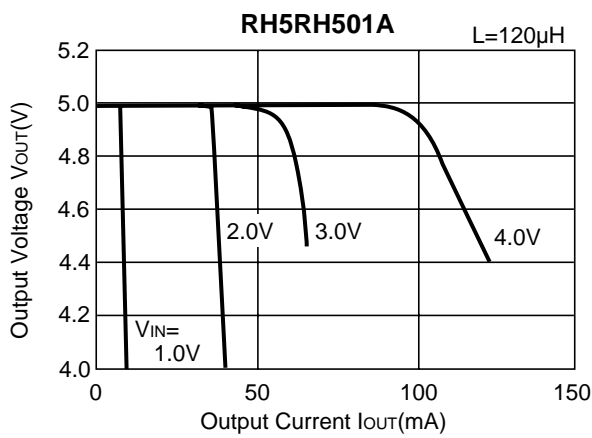
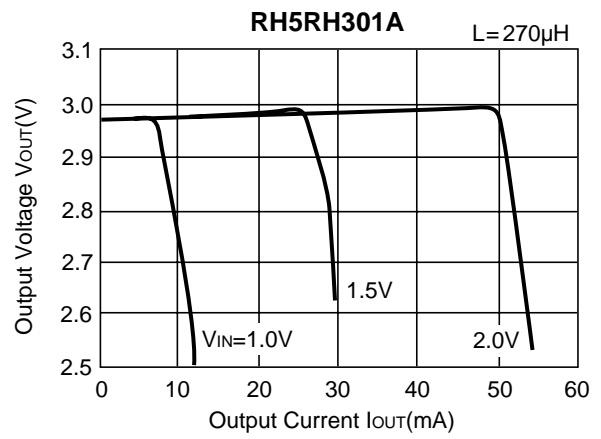
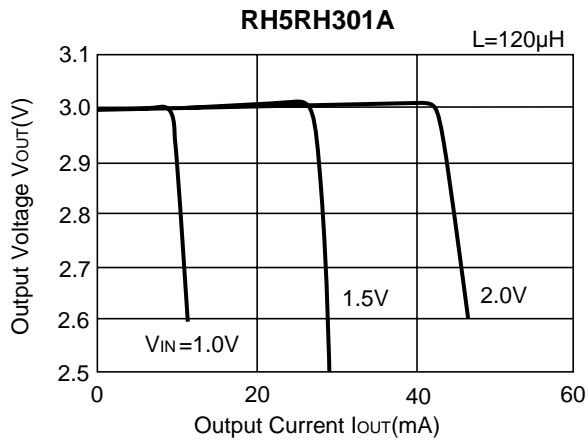

2) Efficiency vs. Output Current

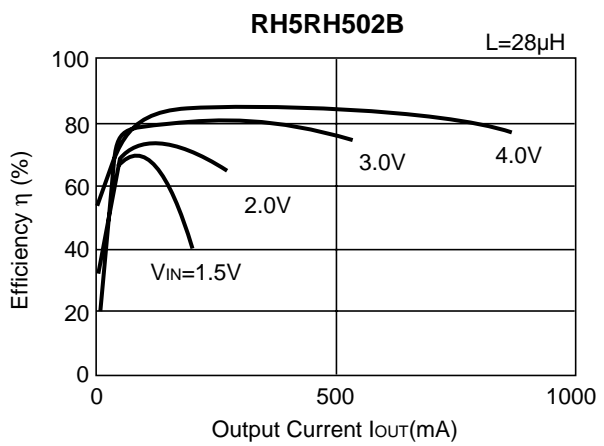
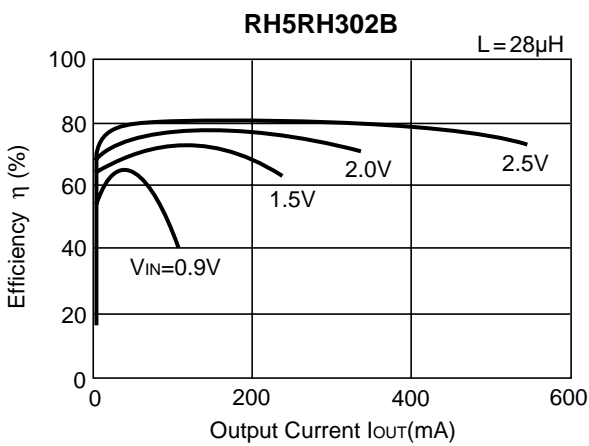
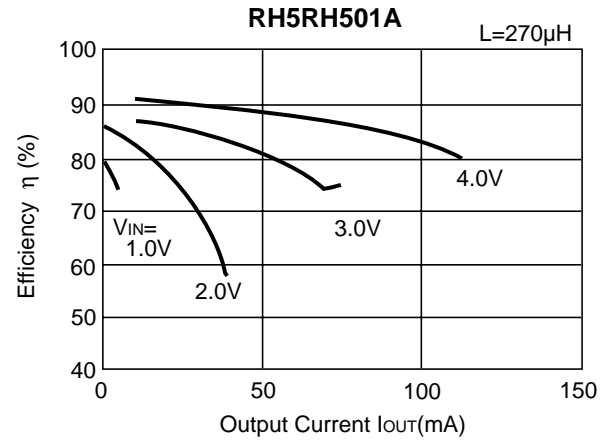
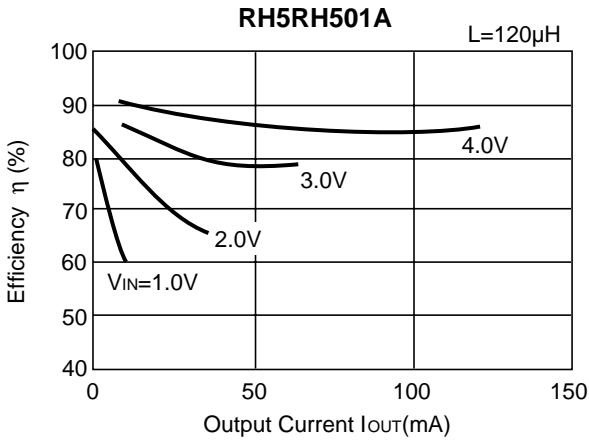
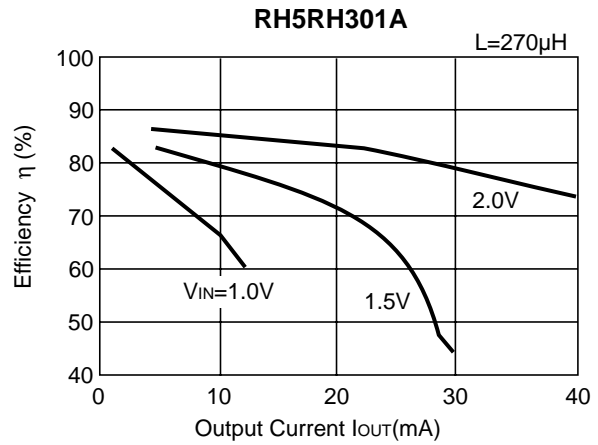
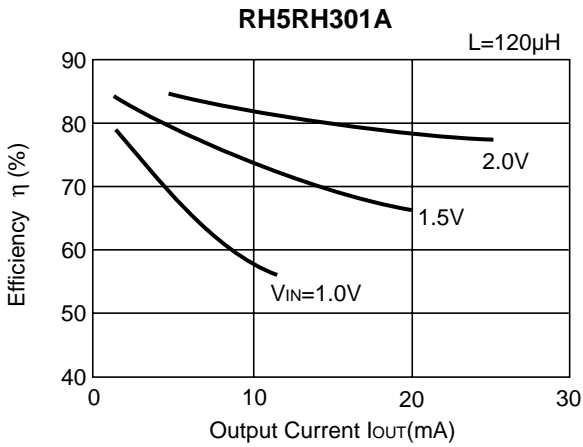

3) Supply Current (No Load) vs. Input Voltage

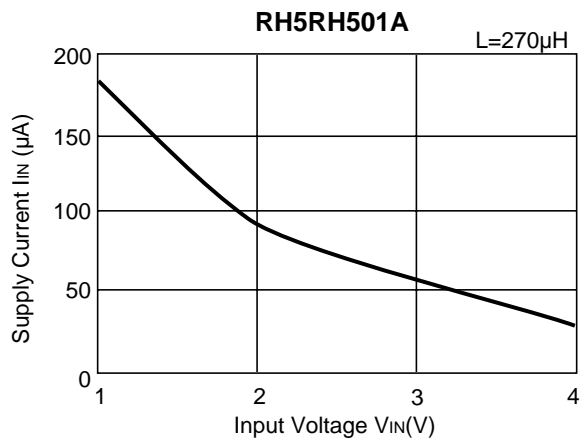
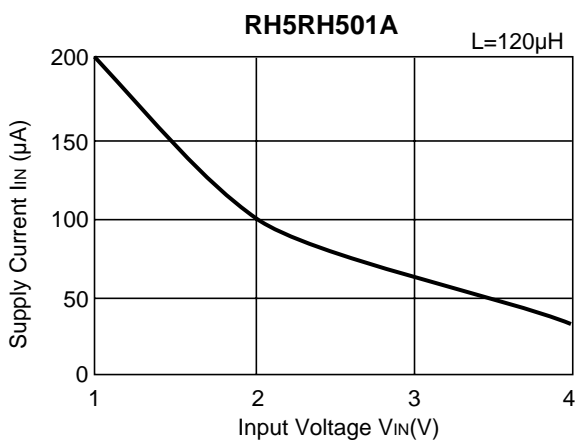
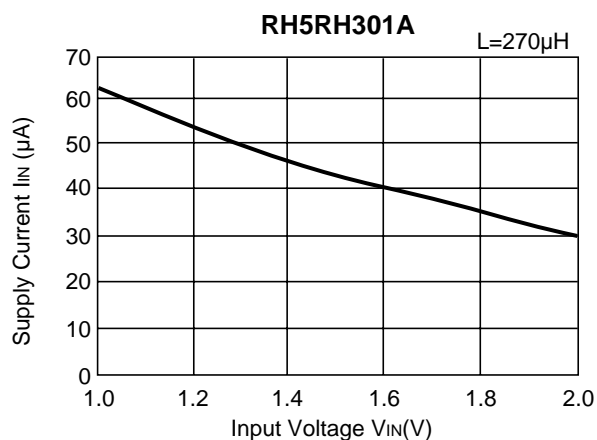
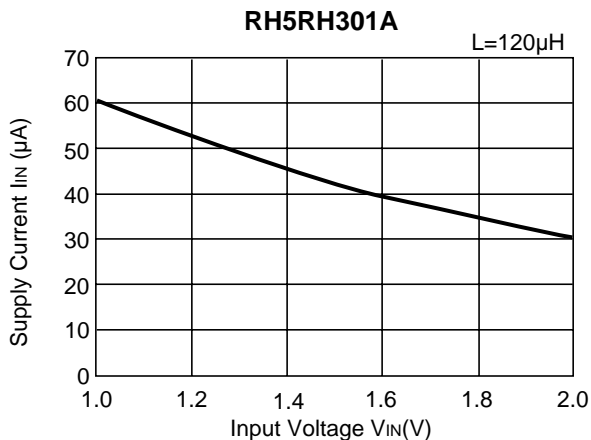

4) Output Current vs. Ripple Voltage

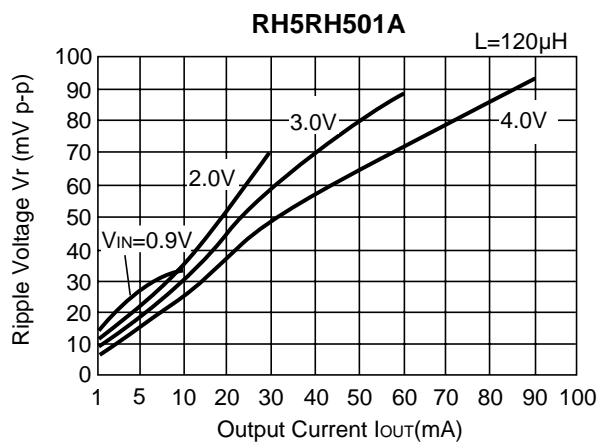
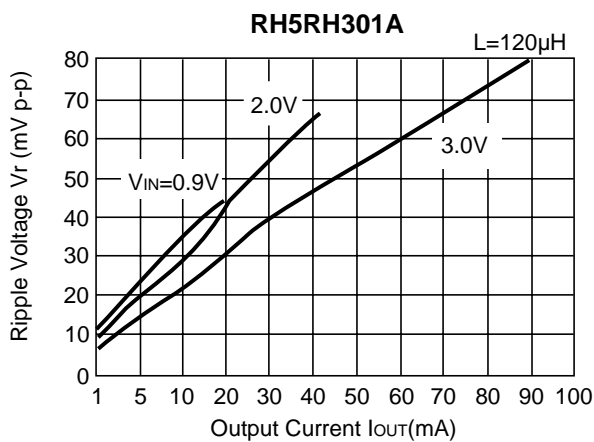

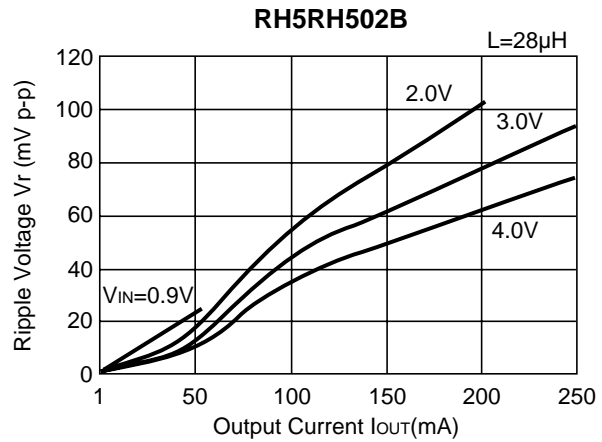
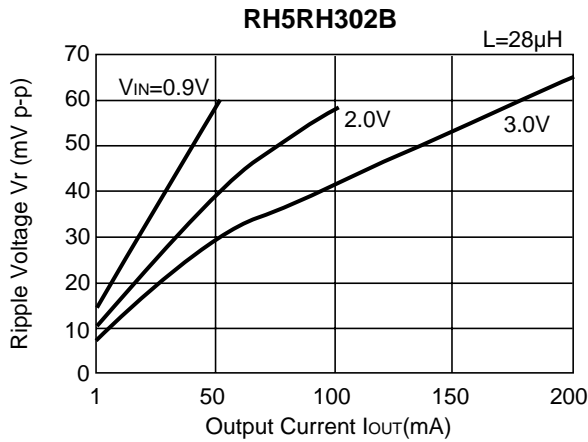
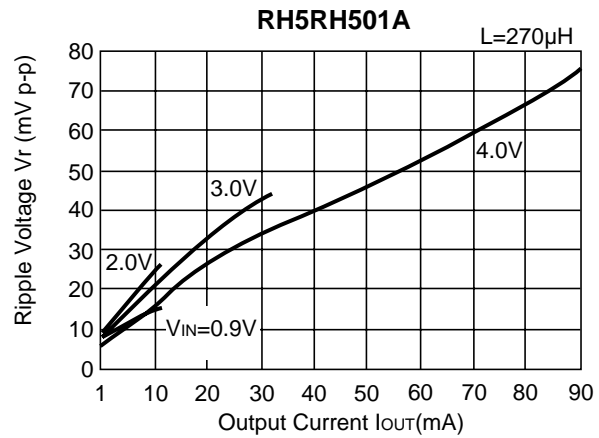
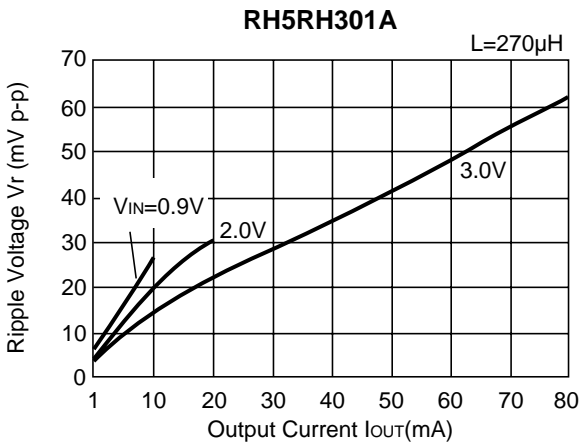

5) Start-up/Hold-on Voltage vs. Output Current ($T_{opt}=25^{\circ}\text{C}$)

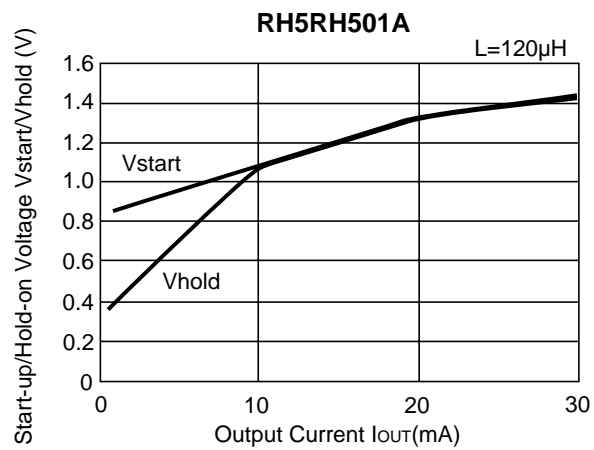
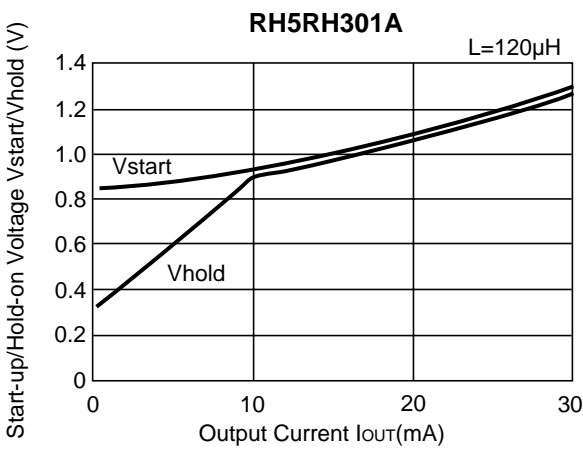

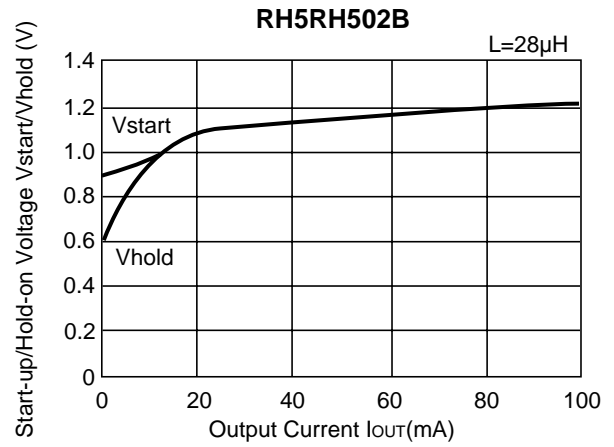
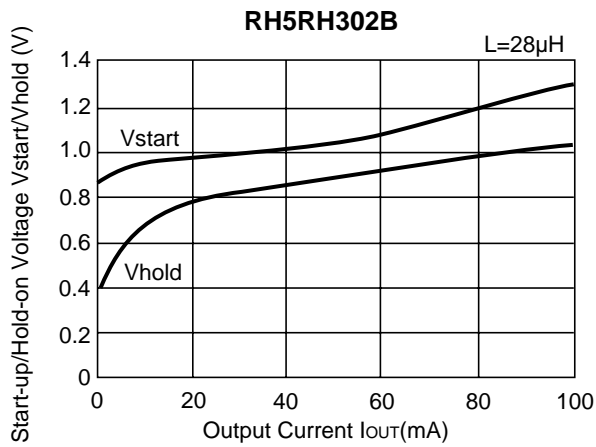

6) Output Voltage vs. Temperature

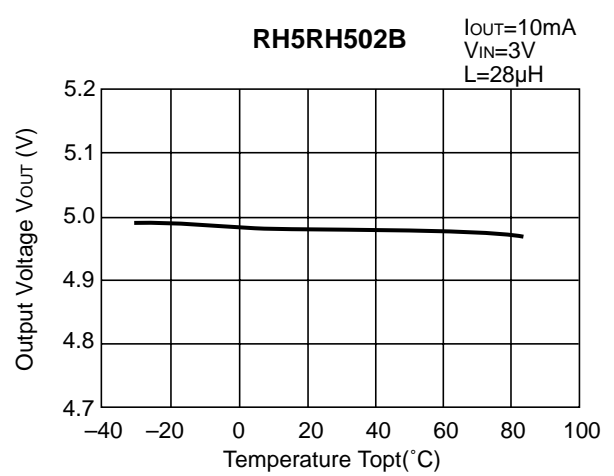
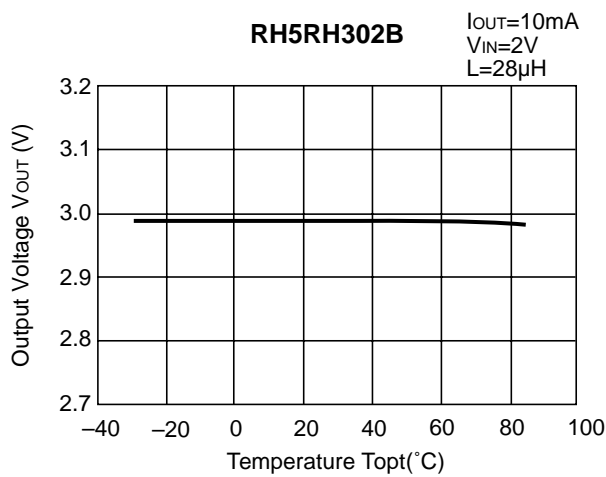
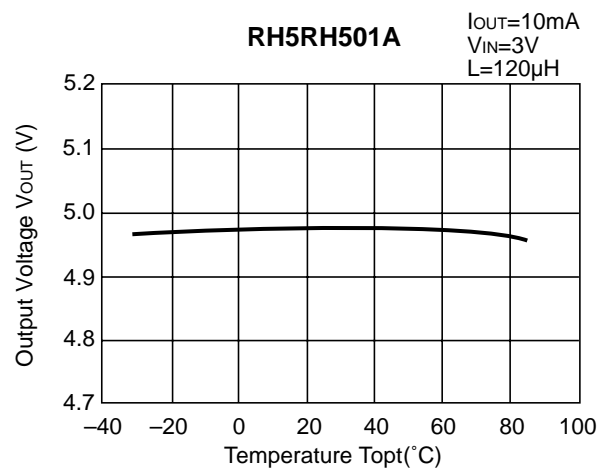
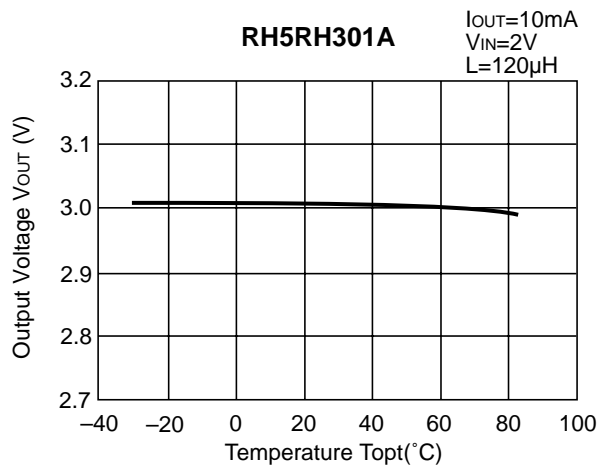

7) Start-up Voltage vs. Temperature

RH5RH501A

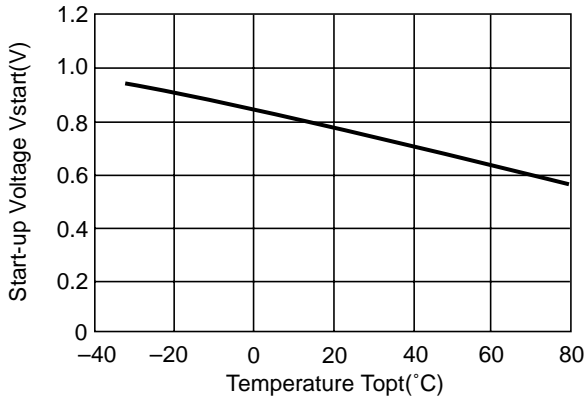

8) Hold-on Voltage vs. Temperature

RH5RH501A

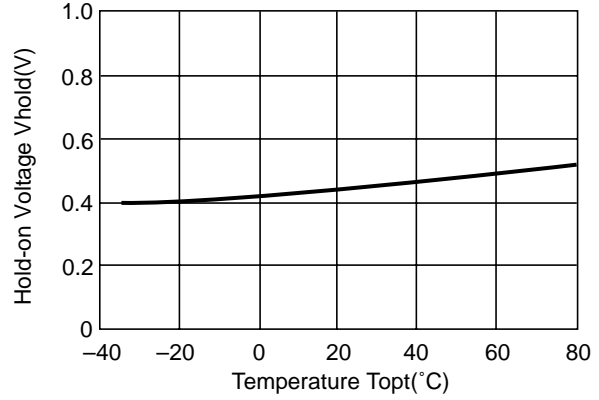

9) Supply Current 1 vs. Temperature

RH5RH501A

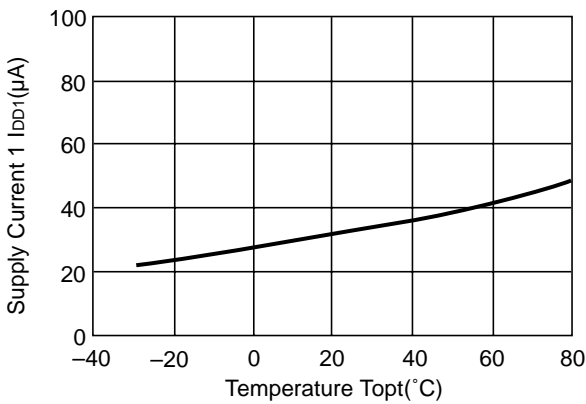

10) Supply Current 2 vs. Temperature

RH5RH501A

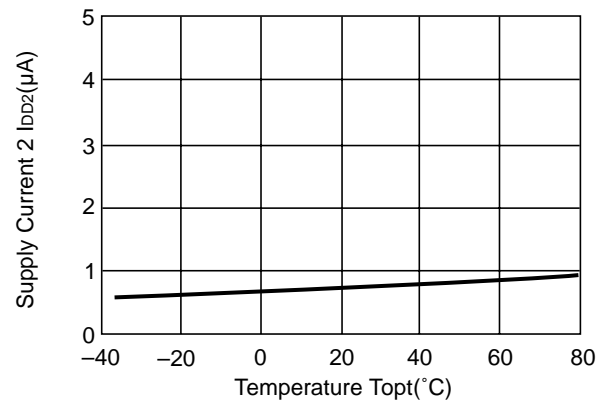

11) Lx Switching Current vs. Temperature

RH5RH501A

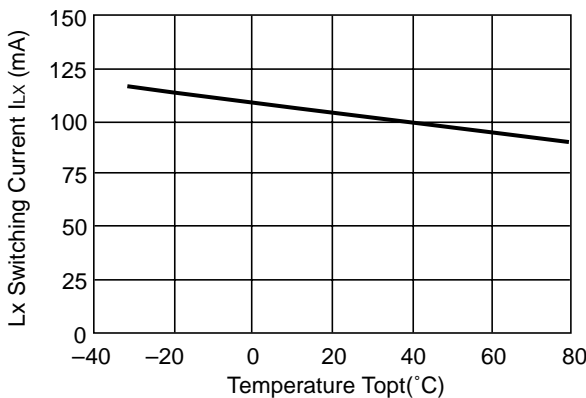

12) Lx Leakage Current vs. Temperature

RH5RH501A

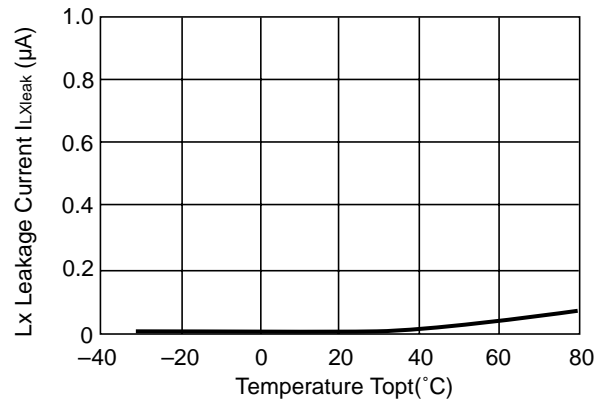

13) Oscillator Frequency vs. Temperature

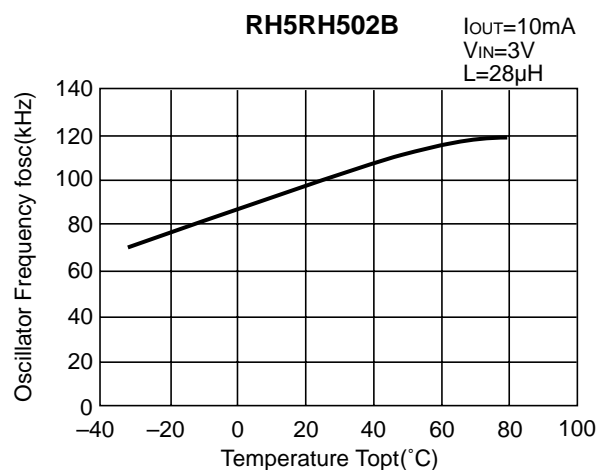
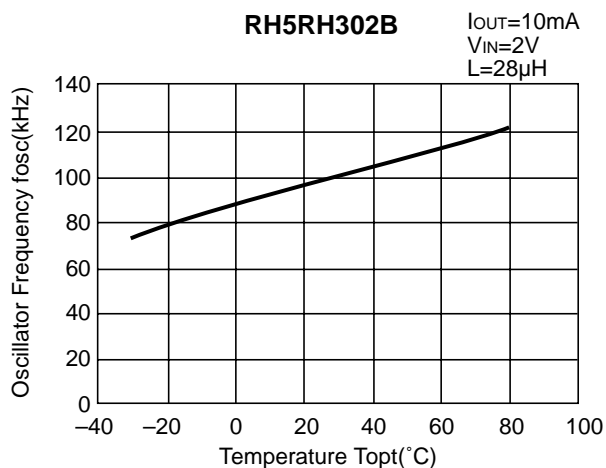
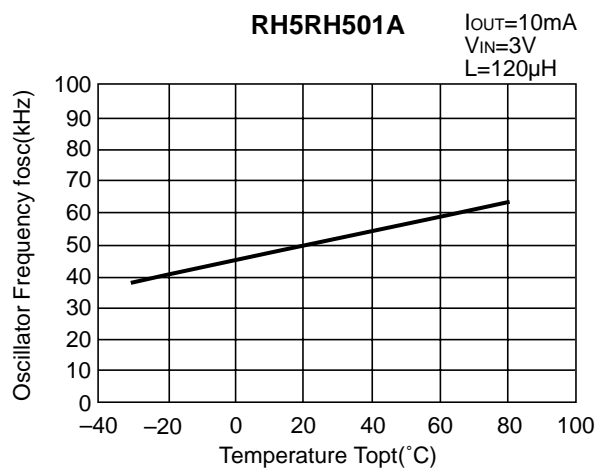
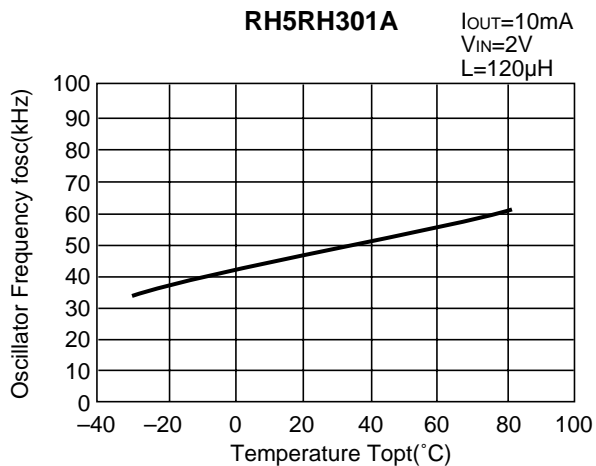

14) Oscillator Duty Cycle vs. Temperature

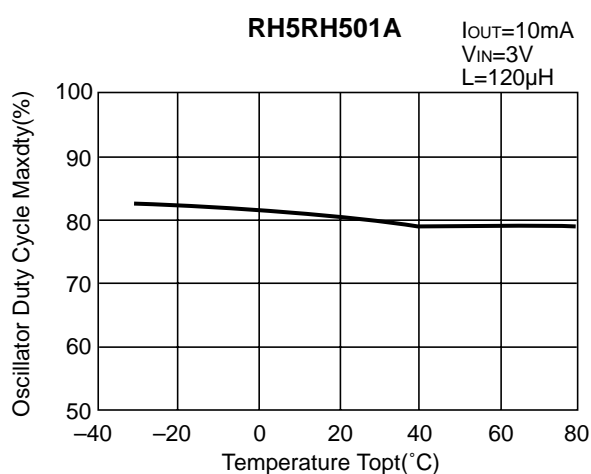
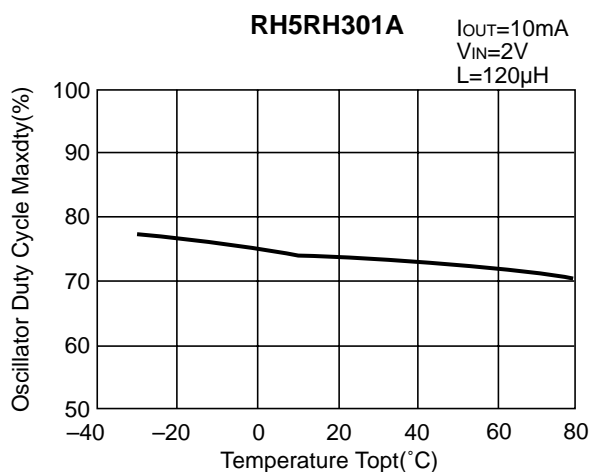

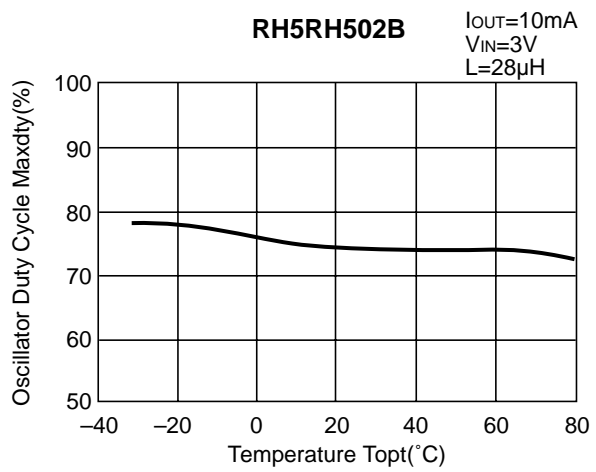
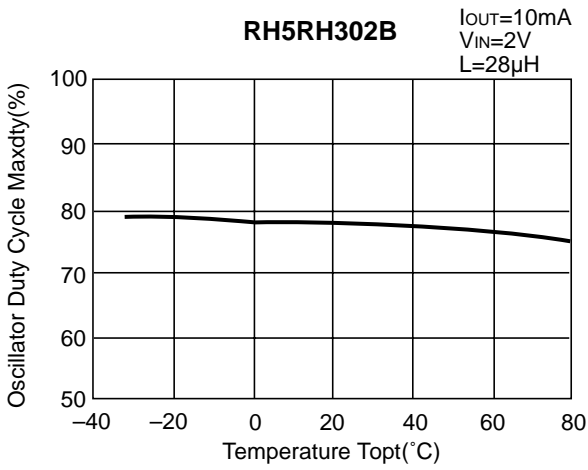

15) VLx Voltage Limit vs. Temperature

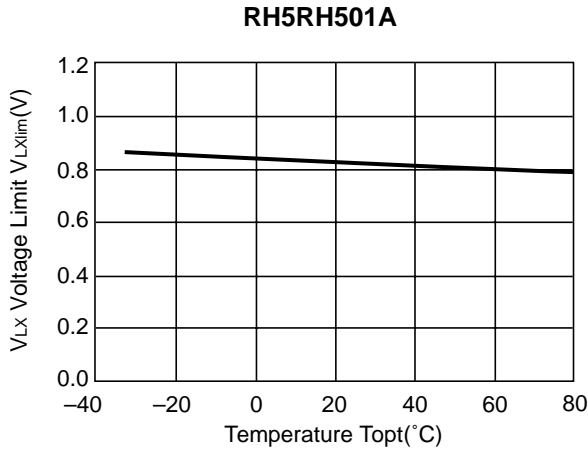

16) EXT "H" Output Current vs. Temperature

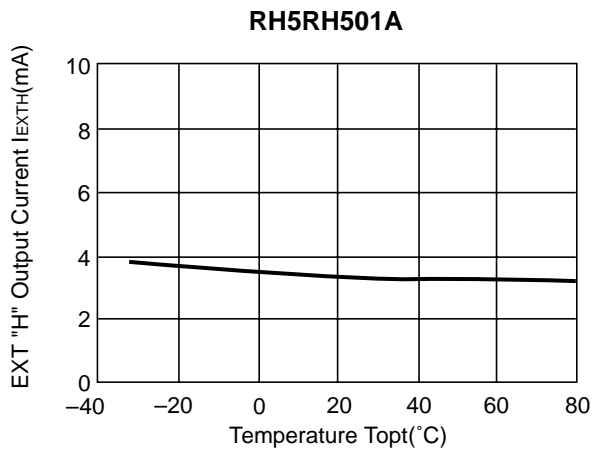

17) EXT "L" Output Current vs. Temperature

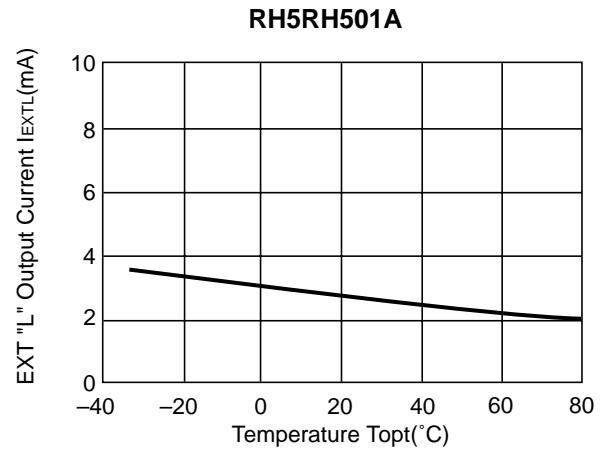

18) Load Transient Response

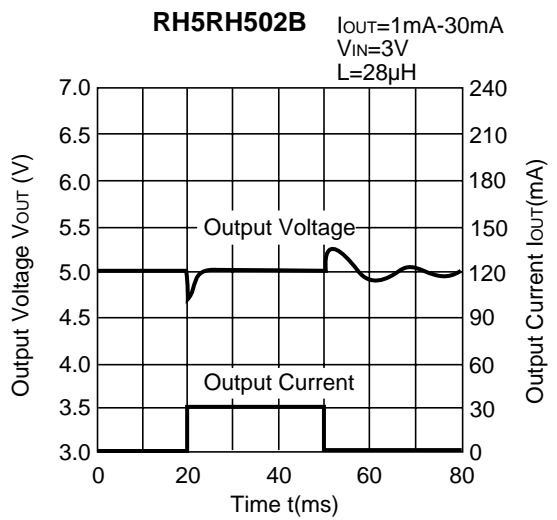
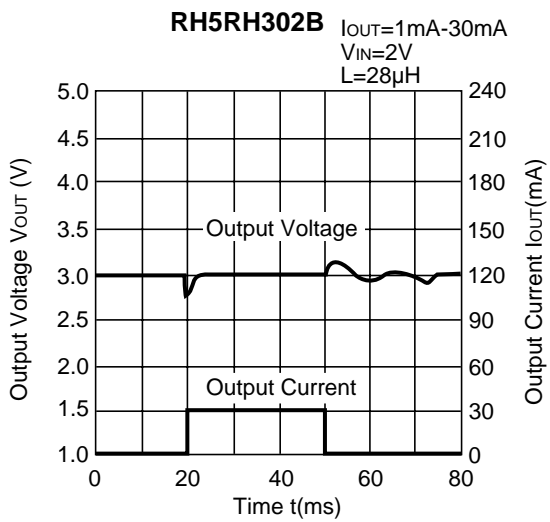
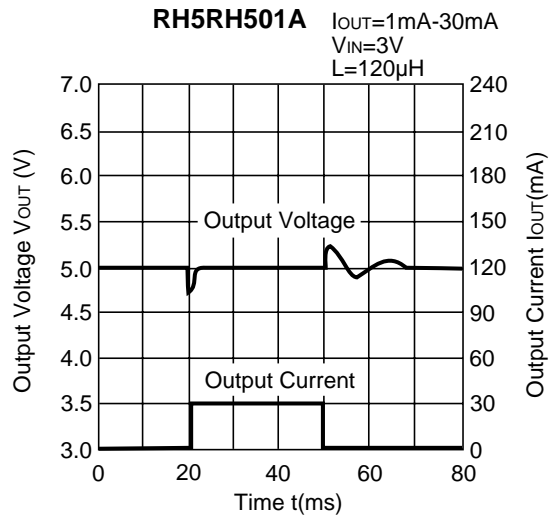
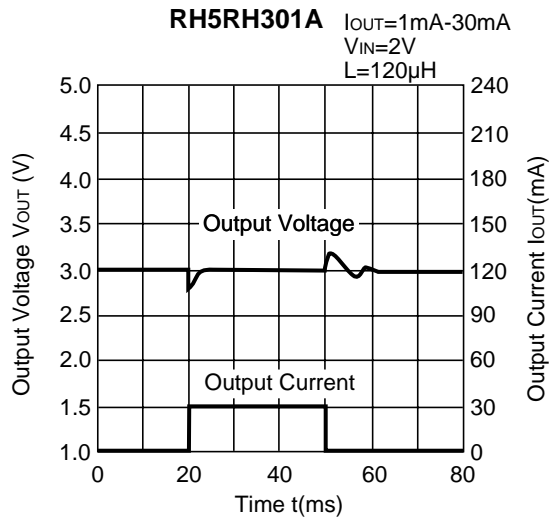

19) Distribution of Output Voltage

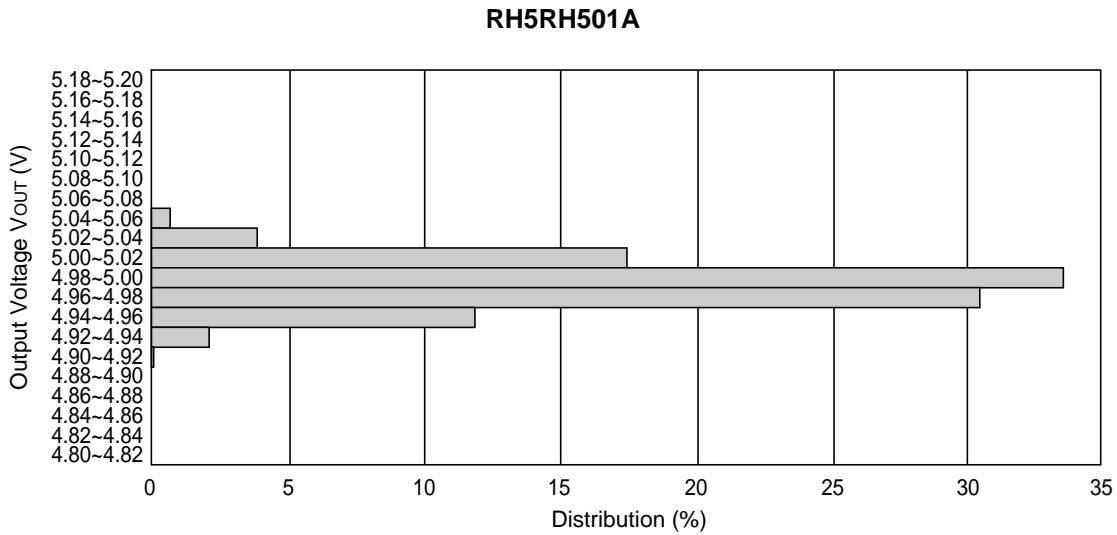

20) Distribution of Oscillator Frequency

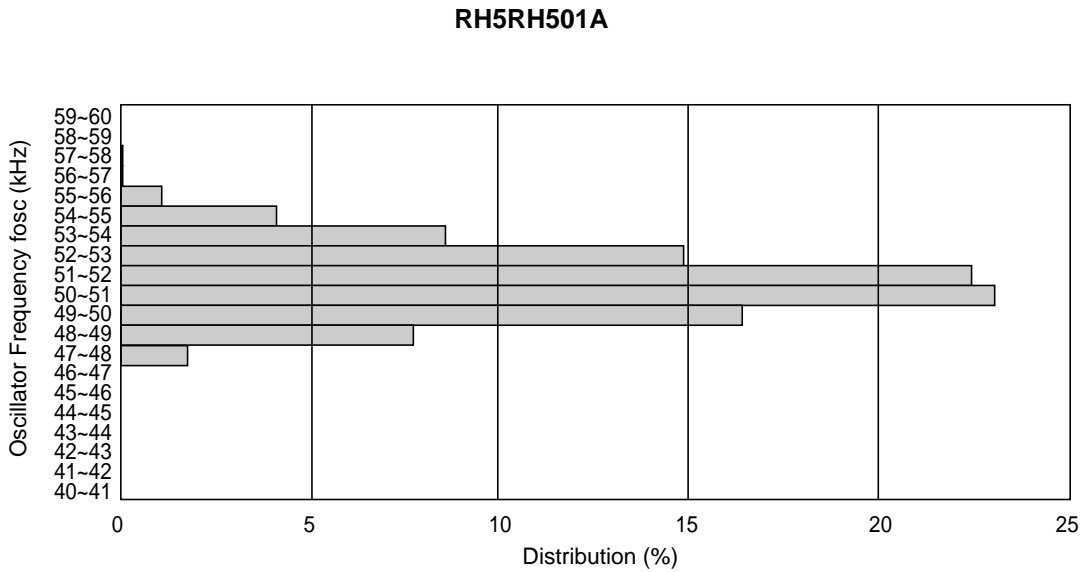

TYPICAL APPLICATIONS

• RH5RH××1A

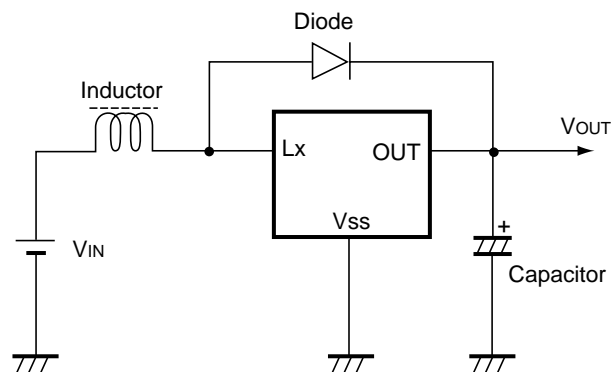

Components Inductor (L)	: 120 μ H (Sumida Electric Co., Ltd.)
Diode (D)	: MA721 (Matsushita Electronics Corporation, Schottky Type)
Capacitor (CL)	: 22 μ F (Tantalum Type)

FIG. 1

• RH5RH××2B

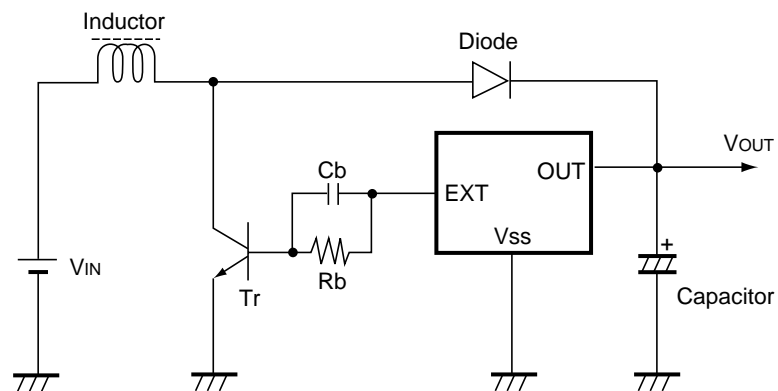

Components Inductor (L)	: 28 μ H (Troidal Core)
Diode (D)	: HRP22 (Hitachi, Schottky Type)
Capacitor (CL)	: 100 μ F (Tantalum Type)
Transistor (Tr)	: 2SD1628G
Base Resistor (Rb)	: 300 Ω
Base Capacitor (Cb)	: 0.01 μ F

FIG. 2

• RH5RH××3B

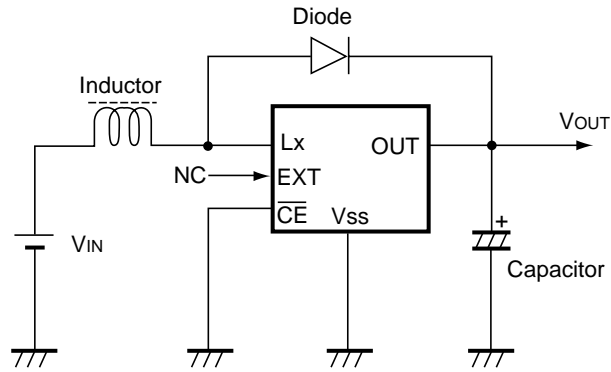

- Components Inductor (L) : 120 μ H (Sumida Electric Co., Ltd.)
- Diode (D) : MA721 (Matsushita Electronics Corporation, Schottky Type)
- Capacitor (CL) : 22 μ F (Tantalum Type)

FIG. 3

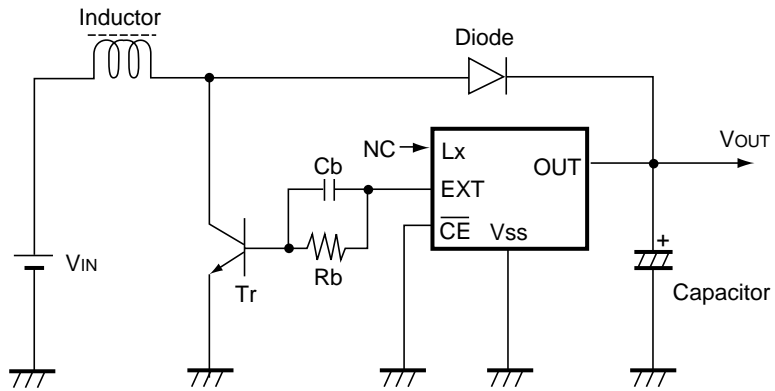

- Components Inductor (L) : 28 μ H (Troidal Core)
- Diode (D) : HRP22 (Hitachi, Schottky Type)
- Capacitor (CL) : 100 μ F (Tantalum Type)
- Transistor (Tr) : 2SD1628G
- Base Resistor (Rb) : 300 Ω
- Base Capacitor (Cb) : 0.01 μ F

FIG. 4

• $\overline{\text{CE}}$ pin Drive Circuit

FIG. 5

APPLICATION CIRCUITS

• 12V Step-up Circuit

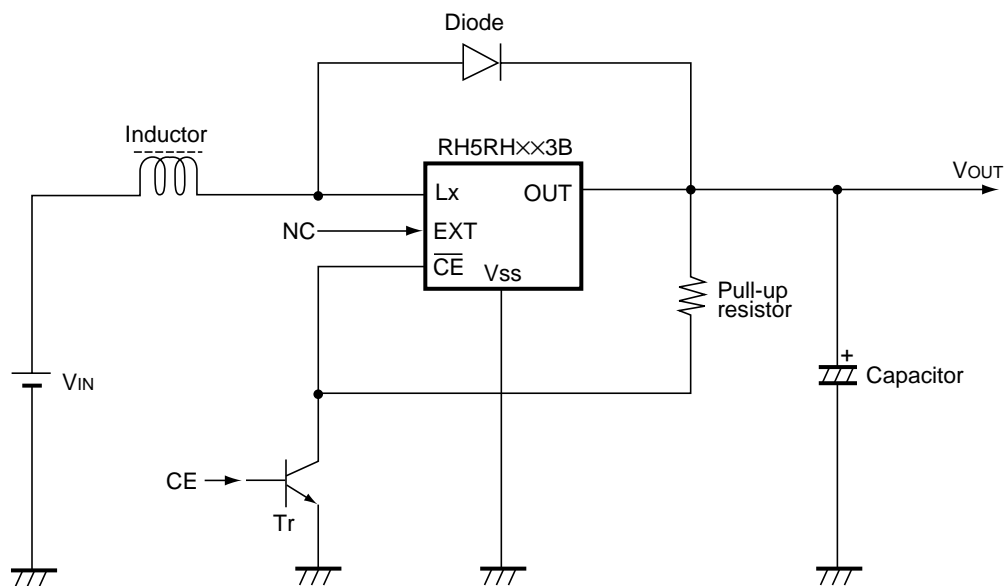
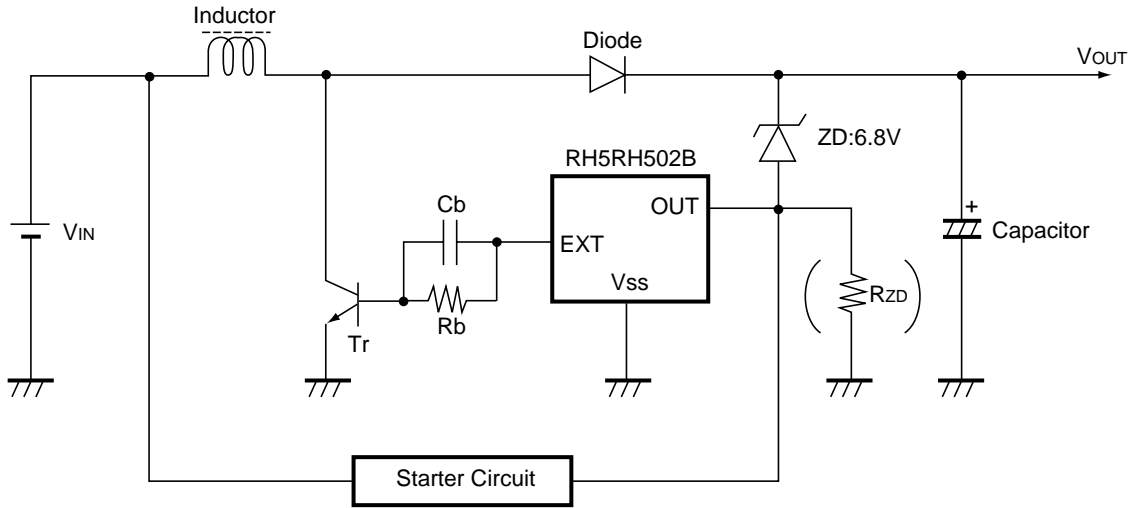

(Note) When the Output Current is small or the Output Voltage is unstable, use the R_{zD} for flowing the bias current through the Zener diode ZD.

FIG. 6

• Step-down Circuit

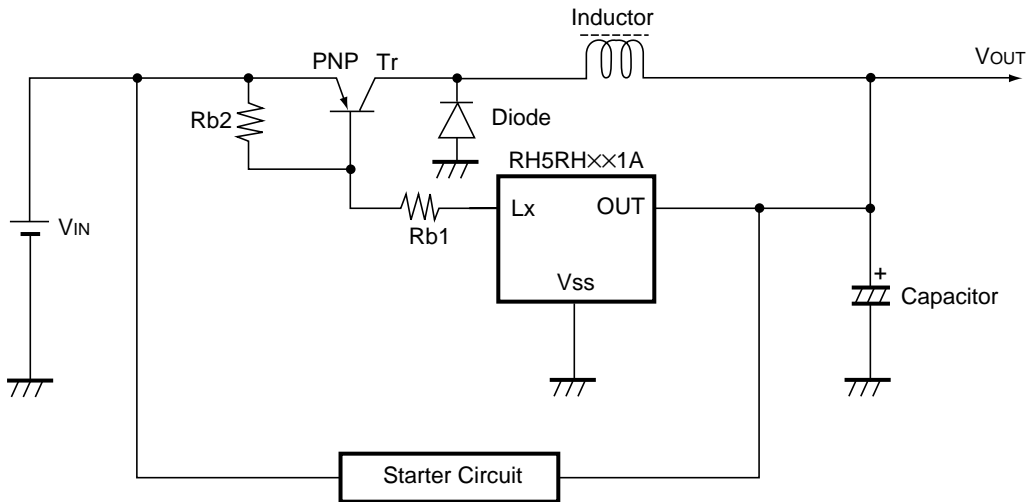

(Note) When the Lx pin Voltage is over the rating at the time PNP Tr is OFF, use a RH5RHxx2B and drive the PNP Tr. by the external NPN Tr.

FIG. 7

• Step-up/Step-down Circuit with Flyback

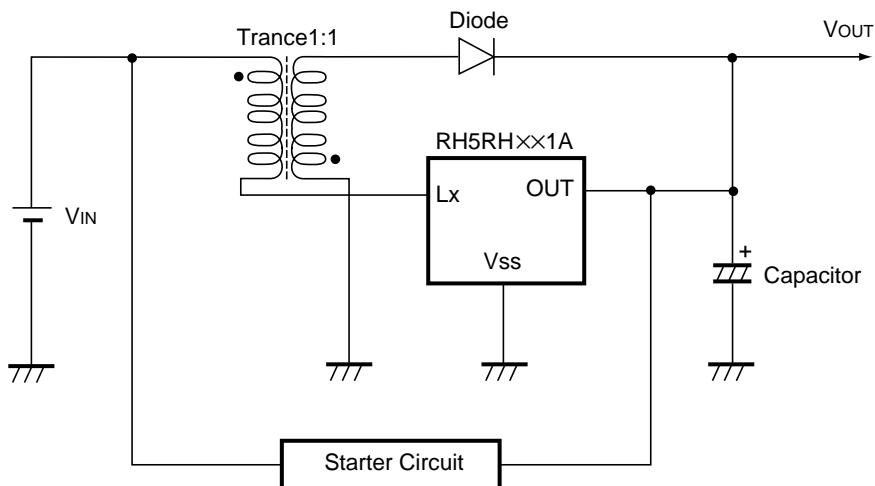

(Note) Use a RH5RHxx2B, depend on the Output Current.

FIG. 8

*The Starter Circuit is necessary for all above circuits.

1. for Step-up Circuit.

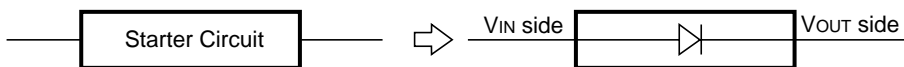

2. for Step-down and Step-up/Step-down Circuit.

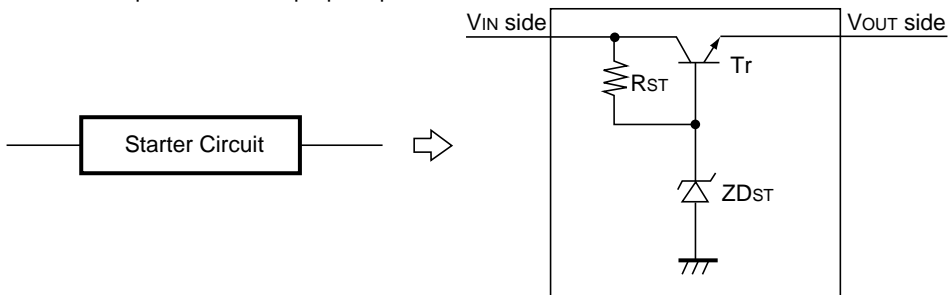

ZDSt $2.5V \leq ZDSt \leq$ Designation of Output Voltage
 Rst Input Bias Current of ZDSt and Tr.
 (several kΩ to several hundreds kΩ)

APPLICATION HINTS

When using these ICs, be sure to take care of the following points :

- Set external components as close as possible to the IC and minimize the connection between the components and the IC. In particular, when an external component is connected to OUT Pin, make minimum connection with the capacitor.
- Make sufficient grounding. A large current flows through Vss Pin by switching. When the impedance of the Vss connection is high, the potential within the IC is varied by the switching current. This may result in unstable operation of the IC.
- Use capacitor with a capacity of 10 μ F or more, and with good high frequency characteristics such as tantalum capacitor. We recommend the use of a capacitor with a resistance to the voltage being at least three times the output set voltage. This is because there may be the case where a spike-shaped high voltage is generated by the inductor when Lx transistor is turned OFF.
- Take the utmost care when choosing an inductor. Namely, choose such an inductor that has sufficiently small d.c. resistance and large allowable current, and hardly reaches magnetic saturation. When the inductance value of the inductor is small, there may be the case where ILX exceeds the absolute maximum ratings at the maximum load. Use an inductor with an appropriate inductance.
- Use a diode of a Schottky type with high switching speed, and also take care of the rated current.
- These ICs are provided with a soft-start circuit. However, there may be the case where the overshoot of the output voltage takes place depending upon the peripheral circuits employed and the input/output conditions. In particular, when the input voltage is increased slowly, the occurrence of the overshoot of the output voltage becomes conspicuous. Therefore in the case where the overshoot becomes a problem, take a countermeasure against this problem, for example, by clamping the output (OUT Pin) by use of a Zener diode.
- The transient response characteristics corresponding to the variations in the input and output are set so as to be slightly delayed by an internal phase compensation circuit in order to prevent the oscillation. because of such setting of the transient response characteristics, take care of the occurrence of the overshoot and/or undershoot of the output voltage.
- The internal phase compensation circuit is designed with the avoidance of the problem of the occurrence of the oscillation fully taken into consideration. However, there may be the case the oscillation takes place depending upon the conditions for the attachment of external components. In particular, take the utmost care when an inductor with a large inductance is used.

The performance of power source circuits using these ICs largely depends upon the peripheral components. Take the utmost care in the selection of the peripheral components. In particular, design the peripheral circuits in such a manner that the values such as voltage, current and power of each component, PCB patterns and the IC do not exceed their respective rated values.