



# ROCKER SWITCH

## Model Information

KCD 1 - 1 02 (E) (N) (L) - 2 C3 - R / B

- Base color
- Cap color
- Cap marking
- Product Number
- Bent terminals
- Neon lamp
- Dot
- Circuit function
- Poles
- Sub-Miniature type
- Rocker Switch

## Specification

1. Rating: ( )6A 125VAC; 3A 250VAC
2. Contact Resistance:35mΩ max
3. Insulation Resistance:500VDC 100mΩ min
4. Dielectric Strength:1500VAC, 1minute
5. Operating Temperature:-25°C~+85°C
6. Electrical Life:10'000 Cycles







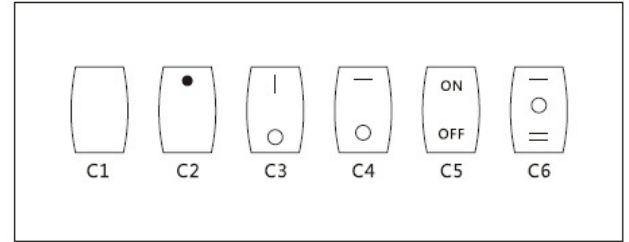

## Circuit function

01	ON	-	OFF
02	ON	-	ON
11	(ON)	-	OFF
12	ON	-	(ON)
03	ON	OFF	ON
13	ON	OFF	(ON)
22	OFF	ON	ON
23	(ON)	OFF	(ON)

( ) Indicates Momentary

## Cap marking



 <p><b>KCD1-101 ON-OFF</b></p>	 <p><b>KCD1-101N-2 ON-OFF</b> <b>KCD1-111-2 (ON)-OFF (单复位)</b> <b>KCD1-102-2 ON-ON</b></p>
 <p><b>KCD1-102 ON-ON</b></p>	 <p><b>KCD1-101N-2</b></p>
 <p><b>KCD1-101-1 ON-OFF</b> <b>KCD1-102-1 ON-ON</b></p>	 <p><b>KCD1-103-2 ON-OFF-ON</b> <b>KCD1-123-2 (ON)-OFF-(ON) (双复位)</b></p>
 <p><b>KCD1-101L-2 ON-OFF</b> <b>KCD1-102L-2 ON-ON</b> <b>KCD1-103L-2 ON-OFF-ON</b></p>	 <p><b>KCD1-101N-3 ON-OFF</b></p>

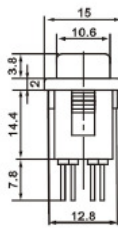
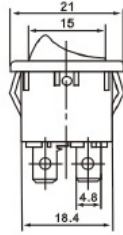
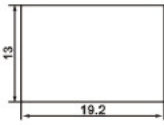

KCD1-201-4 ON-OFF

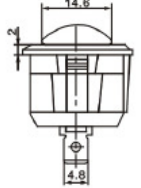
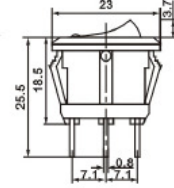
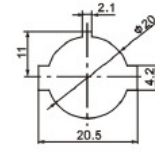

KCD1-101EN-5 ON-OFF

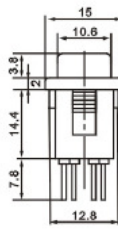
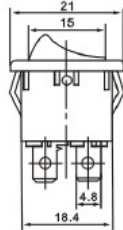
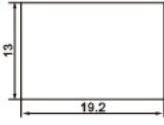

KCD1-201N-4 ON-OFF

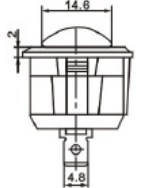
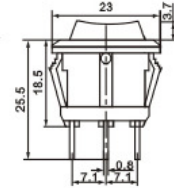
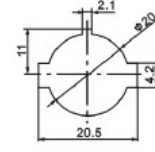

KCD1-103-5 ON-OFF-ON

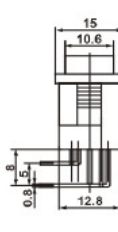
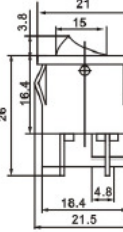
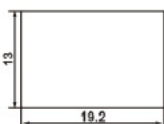

KCD1-201L-4 ON-OFF

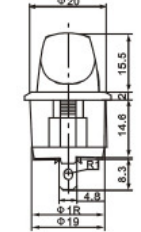
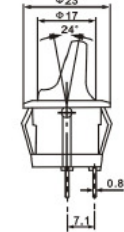
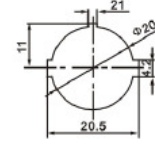

KCD1-101-5H ON-OFF

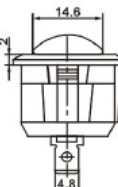
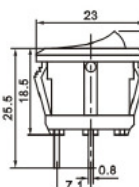
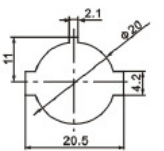

KCD1-101-5 ON-OFF

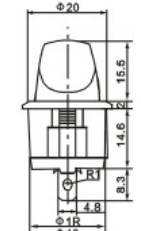
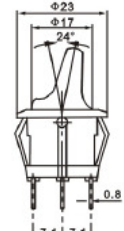
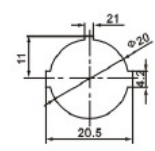

KCD1-102-5H ON-OFF  
 KCD1-101N-5H ON-OFF  
 KCD1-103-5H ON-OFF-ON

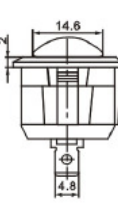
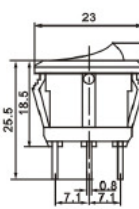
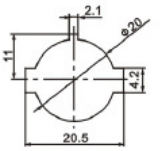

KCD1-102-5 ON-ON

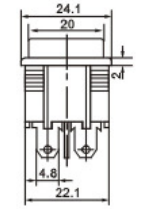
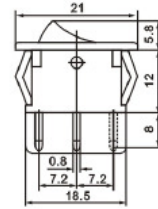
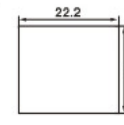

KCD1-201-6 ON-OFF  
 KCD1-201N-6 ON-OFF  
 KCD1-202-6 ON-OFF  
 KCD1-202N-6 ON-ON  
 KCD1-203-6 ON-OFF-ON

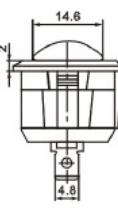
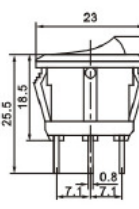
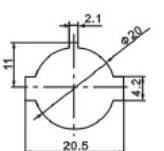

KCD1-101N-5 ON-OFF

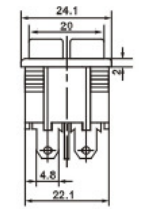
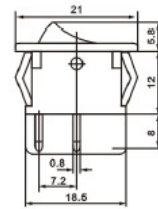
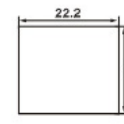

KCD1-2101-6 ON-OFF



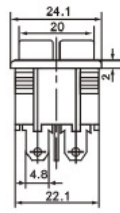
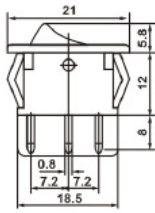
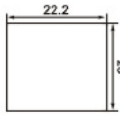

KCD1-2102-6 ON-ON

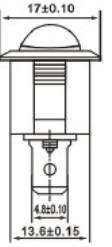
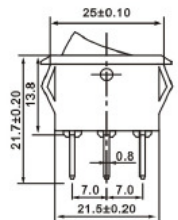
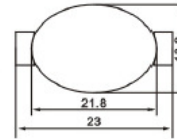

KCD1-102-9 ON-ON  
 KCD1-101N-9 ON-OFF

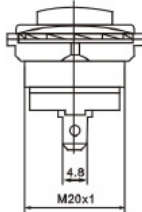
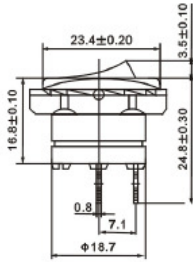

KCD1-101N-7 ON-OFF

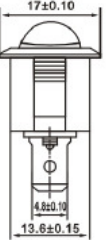
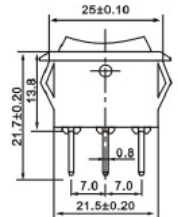
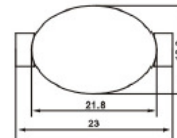

KCD1-103-9 ON-OFF-ON

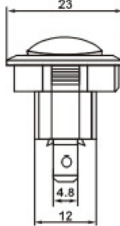
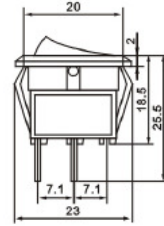
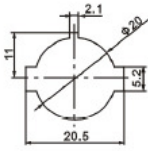

KCD1-101-8 ON-OFF  
 KCD1-102-8 ON-ON

KCD1-103-8 ON-OFF-ON

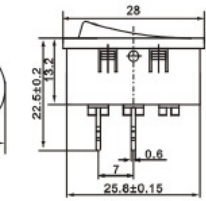
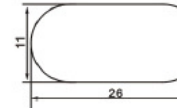

KCD1-101-10 ON-OFF  
 KCD1-102-10 ON-ON

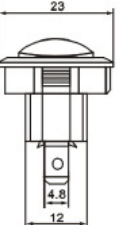
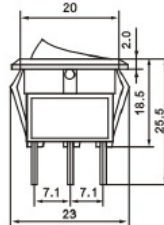
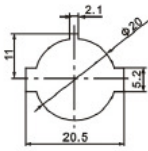

KCD1-101N-8

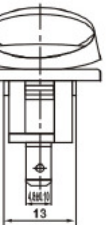
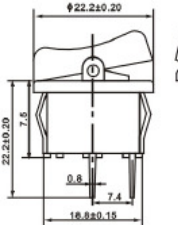
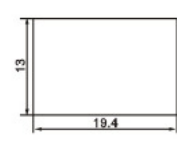

KCD1-101-11

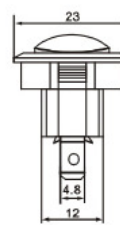
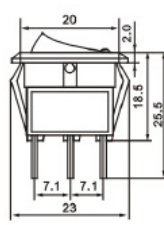
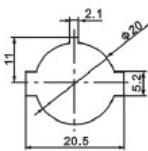

KCD1-101EN-8 ON-OFF

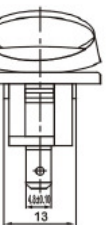
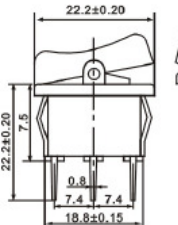

KCD1-102-11 KCD1-103-11

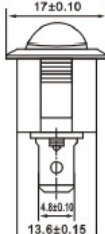
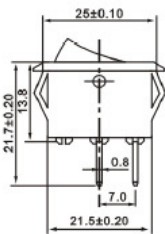
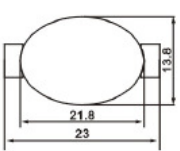

KCD1-101-9 ON-OFF

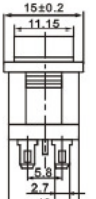
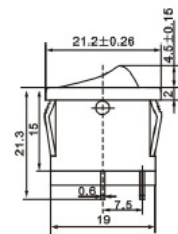
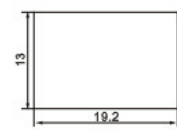

KCD1-201-1 ON-OFF



**ROCKER SWITCH**

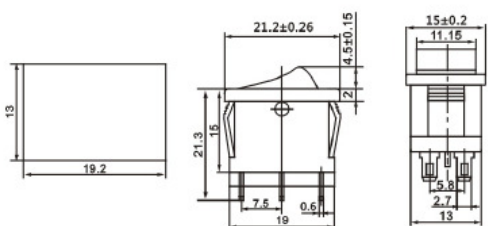

KCD1-202-1 ON-ON

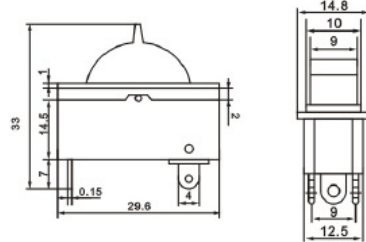

KCD1-122-2 OFF-ON-ON

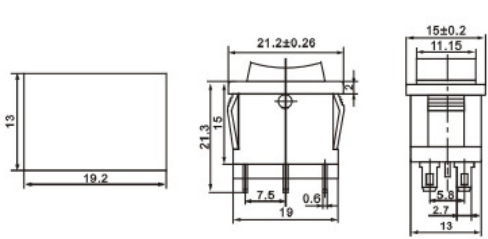

KCD1-203-1 ON-OFF-ON

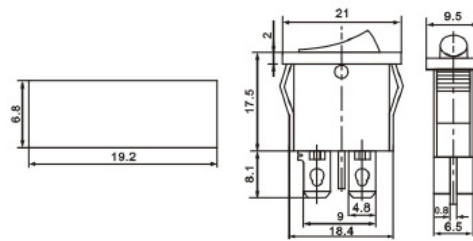

KCD1-101-12 ON-OFF

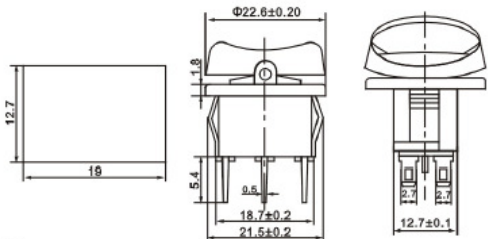

KCD1-202-1R ON-ON  
KCD1-203-1R ON-OFF-ON

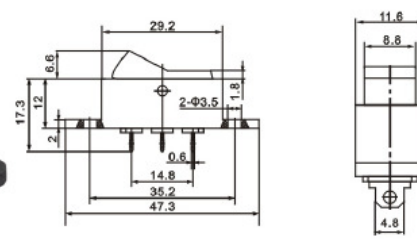

KCD1-102-13 ON-ON

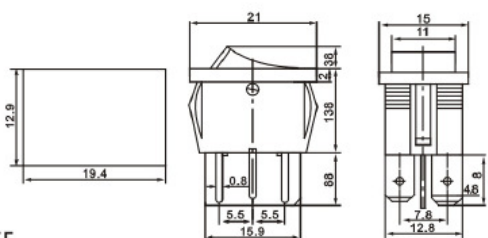

KCD1-201-2 ON-OFF  
KCD1-202-2 ON-OFF  
KCD1-203-2 ON-OFF-ON

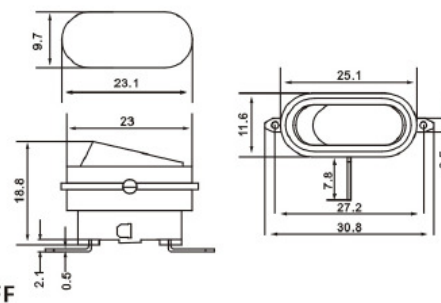

KCD3-101-14 ON-OFF

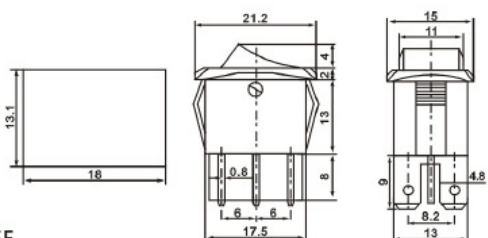

KCD1-201-3 ON-OFF  
KCD1-202-3 ON-ON  
KCD1-203-3 ON-OFF-ON

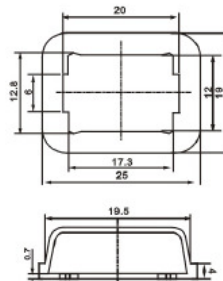

WPC-01  
Waterproof Cover

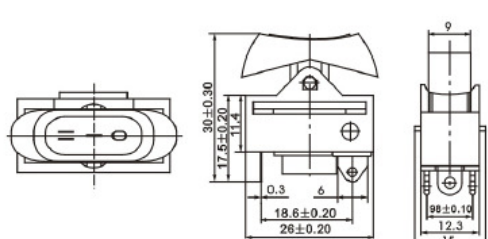

KCD1-122-1 OFF-ON-ON

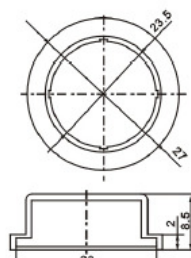

WPC-02  
Waterproof Cover