



2011

EMBEST



New in 2011

- DevKit8500D TI DM3730 Kit
- K7 MID Solution
- TH070S1 Samsung 7-inch HMI Solution
- TH056A1 Atmel 5.6-inch HMI Solution
- TH104A1 Atmel 10.4-inch HMI Solution

EMBEST INFO&TECH CO., LTD

About Embest

Embest Info & Tech Co., Ltd., established in March of 2000, is a privately held international company focused on embedded system technology services. Embest provides custom hardware and software design service with expertise covering many processors (especially ARM microcontrollers) and real time operating systems according to your requirements and OEM/ODM production service.

Embest team has accumulated much experience in a variety of embedded engineering disciplines as following:

- 1) Embedded tools development
- 2) Handheld device
- 3) Industrial control module
- 4) Prototyping
- 5) Embedded hardware/software design and integration

The experience enables us to fully meet the project requirements of our clients. We can cover the complete lifecycle from project definition, initial design and development through deployment. We can port commercial or proprietary software to new targets. We can develop using our embedded design tools to enable faster applications development with fewer errors, and provide you with these tools to enable you to optimize your own developers productivity.

To learn more about Embest, please visit at: www.armkits.com

Partners



Table of Contents

ARM Boards (ARM7/ARM9/ARM Cortex-A8)....	4-19
▪ TI Series.....	4-8
▪ Atmel Series.....	9-14
▪ Samsung Series.....	15-17
▪ NXP Series.....	18-19
MID Solution.....	20
HMI Solution.....	21-23
Video Solution.....	24
USB Oscilloscope.....	25
JTAG Emulator.....	26-27
Embest IDE for ARM.....	28-29
Flash Programmer.....	30-31
Educational Kits.....	32-33
Custom Design Service.....	34-35



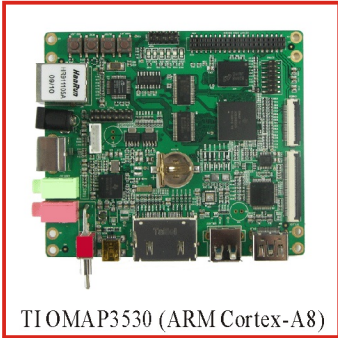

TI OMAP3530 (ARM Cortex-A8)



Android System Support



DVSDK Software Package



Angstrom System Support

Features

- 110mm*95mm
- Working Temp.: 0~70 Celsius
- Processor: TI OMAP3530
- Power supply: +5V
- 256MB DDR SDRAM, 166MHz
- 256MB Nand Flash, 16bit
- 24-bit color TFT LCD & TSP interface
- DVI high-resolution image output port
- S-Video display interface
- Audio input interface
- 2-channel Audio output interfaces
- 10/100M Ethernet port (RJ45)
- High-speed USB2.0 OTG port
- High-speed USB2.0 Host port
- 2 Serial ports
- Camera interface
- SD/MMC card slot
- Expansion connector (McSPI, McBSP, I2C, HDQ, GPIO are led out from this connector)
- 14-pin JTAG interface
- 6*6 Keyboard interface
- 4 Buttons
- Provides demos of Google Android OS and Angstrom
- Supports Linux2.6 and WinCE6.0

Features

- 136.2mm*105.3mm
- Working Temp.: 0~70 Celsius
- TI DM3730 microprocessor with 800MHz ARM Cortex-A8 RISC core and 800MHz TMS320C64x+TM DSP core
- Power supply: +5V
- 512MB DDR SDRAM, 32bit, 200MHz
- 512MB Nand Flash
- 8*512MB iNAND, 4bit
- 24-bit color TFT LCD & TSP interface
- DVI high-resolution image output port
- S-Video display interface
- Audio input interface
- 2-channel Audio output interfaces
- 10/100M Ethernet port (RJ45)
- 1 High-speed USB2.0 OTG port
- 4 High-speed USB2.0 Host ports
- 3 Serial ports
- Camera interface
- SD/MMC card slot
- Expansion connector (McSPI, McBSP, I2C, HDQ, GPIO are led out from this connector)
- 14-pin JTAG interface
- 6*6 Keyboard interface
- 4 Buttons
- 5 LEDs
- Supports Linux2.6 and Android2.2
- Supports WinCE6.0

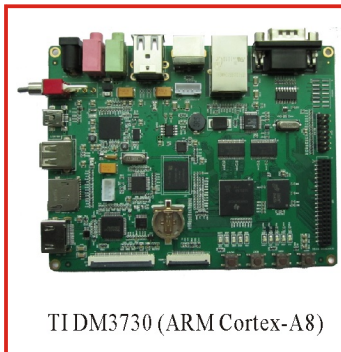

TI DM3730 (ARM Cortex-A8)

Features

- 96mm*90mm (SOC8200 Single Board Computer)
170mm*190mm (SOC8200 expansion board)
- Working Temp.: -40~85 Celsius
- Processor: TI AM3517
- Power supply: +5V (SOC8200), +12V (Expansion Board)

SOC8200 Single Board Computer

- 256MB DDR2 SDRAM, 32bit
- 256MB NAND Flash, 8bit
- 4MB Nor Flash
- One 5-wire RS232 Debug serial port
- One 5-wire TTL serial port
- One RS485 serial port
- Two High-speed USB 2.0 Host ports
- One High-speed USB 2.0 Device port
- 1-channel CAN bus
- 10/100M Ethernet port
- Audio (IIS)
- 16-bit LCD output
- 10-bit Camera video input
- 1-channel S-Video output
- 1-channel AV output
- SD/MMC card slot
- Multi-functional expansion interface (McBSP, IIC, McSPI, TV-OUT)
- PC104 expansion interface (GPMC Bus, MMC, USB, McSPI, UART1, Clock, HDQ)
- JTAG interface



SOC8200 Expansion Board

- One 5-wire RS232 serial port (DB9)
- One 9-wire RS232 serial port (DB9)
- One 9-wire TTL serial port (2*5pin 2.5mm pitch connector)
- Two High-speed USB 2.0 Host ports
- One High-speed USB 2.0 Device port
- 10/100M Ethernet port (RJ45)
- 10-bit Camera interface
- Reset button
- SD/MMC card slot
- CF card slot
- Audio input port
- Stereo Audio output port
- 15-pin standard VGA output interface
- Buzzer
- Supports Linux2.6

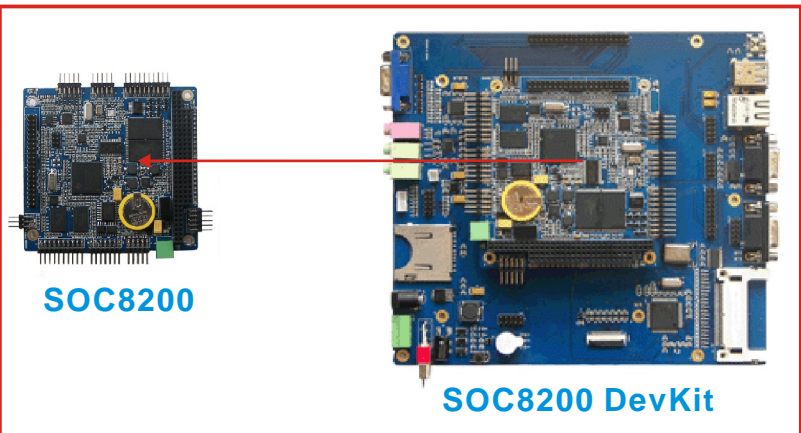

SBC8100

Mini8100, USB, NET, LCD,
S-Video/TV, VGA, WiFi, GPS

Features

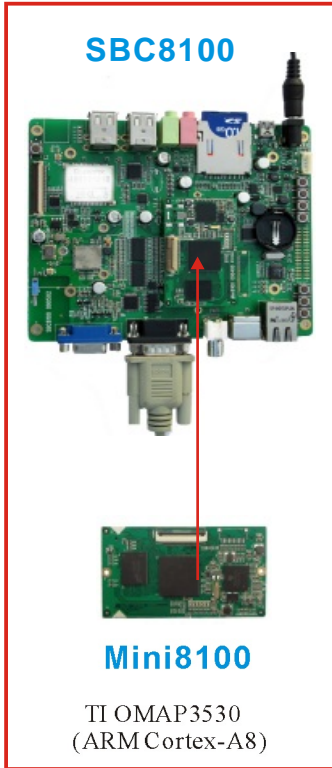

- 144.9mm*114.1mm (expansion board)
67mm*37mm (CPU board Mini8100)
- Working Temp.: 0~70 Celsius
- Power supply: +5V
- Processor: TI OMAP3530 (on Mini8100)
- 256MB DDR SDRAM (on Mini8100)
- 256MB Nand Flash, 16bit (on Mini8100)
- 12-bit camera interface (on Mini8100)
- 6 LEDs (on Mini8100)
- 10-pin JTAG interface (on Mini8100)
- 4 High-speed USB2.0 Host ports
- 1 High-speed USB2.0 OTG port
- RS232 Debug serial port
- 10/100M Ethernet port
- LCD/Touch Screen interface
- Standard VGA interface
- S-Video/TV interface
- Audio input and output ports
- WiFi/Bluetooth Module
- GPS Module
- SD card slot
- 4*5 Keyboard interface
- Expansion interface (2.54mm 30-pin SMT Female Pin Header, UART, I2C, SPI, ADC_IN, PWN_OUT are led out from this connector)
- Supports Linux 2.6 and WinCE 6.0

SBC6300X

Mini6300, 200MHz, 8UARTs,
2NET, USB, CAN, LCD, SD,

Features

- 150mm*143.5mm(expansion board)
52mm*52mm (CPU board Mini6300)
- Working Temp.: -10~70 Celsius
- Power supply: +12V
- Processor: AtmelAT91SAM9263
- 64MB SDRAM
- 128MB Nand Flash
- 2Kbit EEPROM
- 8 Serial ports (Debug: 3-wire RS232/TTL,
COM0: 5-wire RS232/TTL,
COM1: 5-wire RS232/TTL,
COM2: 3-wire RS232/TTL/half-duplex
RS485, EXT_COM1/2/3/4: 5-wire RS232)
- 2 USB Host and 1 USB Device
- Two 10/100M Ethernet ports
- CAN2.0 interface
- 2*20-pin LCD interface
- Touch Screen interface
- TWI interface
- Audio input and output ports
- 8-channel 12-bit ADC
- 6*6 Keyboard interface
- SD card slot
- 41 GPIOs
- 4 Buttons
- 20-pin Panel interface
- Buzzer
- Battery backed RTC
- 20-pin JTAG interface
- Supports Linux2.6 and WinCE6.0

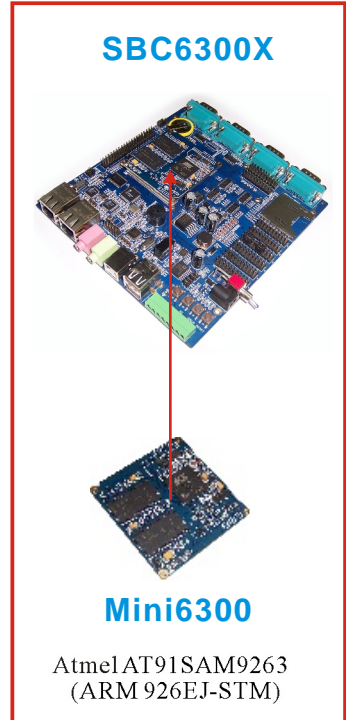

MINI6045

400MHz, DDR2 SDRAM, RTC,
LCD, LVDS, NET, USB, TF

SBC6045 Features

- 185mm*125mm (expansion board)
82mm*67mm (CPU board Mini6045)
- Working Temp.: -10~70 Celsius
- Power supply: +5V (CPU board), +12V (expansion board, with isolation power)

SBC6045 CPU Board (Mini6045)

- Processor: Atmel AT91SAM9G45
- 128MB*2 DDR2 SDRAM
- 256MB Nand Flash
- 4MB Data Flash
- 2Kbit EEPROM
- Precise RTC
- Watchdog timer
- High-speed USB2.0 OTG port
- 10/100M Ethernet port
- 40-pin LCD interface with 4-wire resistive touch screen interface
- LVDS interface (Supports 8-bit LCD resolution up to 1280*860 pixels)
- TF card slot
- Power indicator
- System working status indicator
- Two 2.0mm pitch 80-pin expansion connectors (UART 0-3, Debug serial port, Ethernet, USB OTG, LVDS, 2 SPI, 2 TWI, SDIO, PWM, ISI, AC97, Touch Screen, JTAG and all IOs are led out via the two connectors.)
- Supports Linux2.6

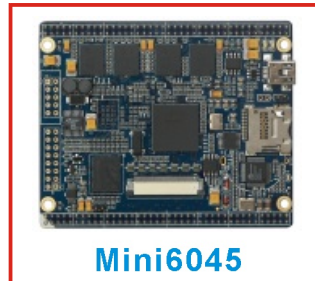

SBC6045 Expansion Board

- 5 Serial ports (Debug serial port: 3-wire RS232, COM0:3-wire RS232/RS485 with isolation, COM1: 5-wire RS232, COM2: 3-wire RS232/RS485 with isolation, COM3: 3-wire RS232/TTL)
- High-speed USB2.0 Host port
- 10/100M Ethernet port
- 2 CAN 2.0 interfaces (extended through 2 SPI, with power and signal isolation)
- TWI interface with speed up to 400kbps
- SPI interface
- 24-bit LVDS signal interface (for large size LCD panel displays, supports resolution up to 1280*860 pixels)
- 4-wire resistive touchscreen interface
- Audio output port
- Buzzer
- Power switch
- 20-pin JTAG interface
- IO button
- Reset button
- DC Power input port
- Supports Linux2.6

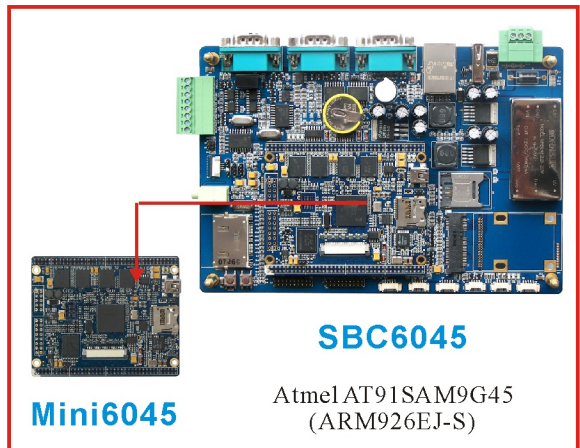

SBC9261-I

Mini9261-I, 200MHz, 4UARTs,
LCD, VGA, NET, CAN, USB, SD

SBC9261-I

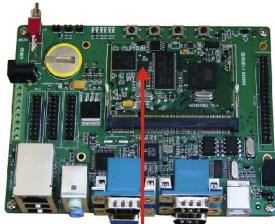

Mini9261-I

Atmel AT91SAM9261S
(ARM926EJ-S)

Features

- 141.4mm*109.5mm (expansion board)
67.6mm* 47mm (CPU board Mini9261-I)
- Working Temp.: 0~70 Celsius
- Power supply: +12V
- Processor: Atmel AT91SAM9261S
- 64MB SDRAM
- 128MB Nand Flash (256MB for option)
- 4MB SPI Serial DataFlash
- 4MB Nor Flash (8MB for option)
- 1Kbit EEPROM (DS2431)
- 2 USB Host and 1 USB Device
- 4 Serial ports (COM0: 3-wire RS232/TTL
Debug serial port, COM1: 5-wire
RS232/TTL, COM2: one 9-wire RS232,
one RS485 or one 3-wire TTL)
- CAN2.0 interface
- 10/100M Ethernet port
- 2*20-pin LCD interface
- Touch Screen interface
- VGA interface
- 4*4 Keyboard interface
- SD card slot
- 20-pin standard JTAG interface
- Audio input and output ports
- Battery backed RTC
- 13 GPIOs
- LEDs
- 4 Buttons
- Supports Linux2.6 and WinCE6.0

SBC6000X

200MHz, 3UARTs, USB, NET,
LCD, SD, Keyboard, GPIO, Bus

Features

- 106.5mm*94mm
- Working Temp.: -10~70 Celsius
- Power supply: +12V
- Processor: AtmelAT91SAM9261S
- 64MB SDRAM (128MB for option)
- 128MB Nand Flash (256MB for option)
- 2Kbit EEPROM
- 4/8Mbyte DataFlash (Reserved for soldering, bootable, multiplex with SD/MMC interface)
- 2 USB Host and 1 USB Device
- 3 Serial ports (COM0: 3-wire Debug serial port, COM1: 5-wire RS232/TTL, COM2: 5-wire RS232/TTL/RS485)
- 10/100M Ethernet port
- 2*20-pin LCD interface
- Touch Screen interface
- SD card slot
- 4*4 Keyboard interface
- Audio input and output ports
- Battery backed RTC
- Buzzer
- 16 GPIOs (10 from CPU, 6 from extension)
- LEDs (CPU working station indicator)
- 3 Buttons
- Bus interface (with buffer)
- Supports Linux2.6 and WinCE6.0





Features

- 150mm*106mm
- Working Temp.: -10~70 Celsius
- Power supply: +12V
- Processor: Atmel AT91SAM9G20
- 64MB SDRAM
- 128MB Nand Flash (256MB for option)
- 4MB Nor Flash
- 2Kbit EEPROM
- 7 Serial ports (Debug: 3-wire RS232, COM0: 5-wire RS232/TTL, COM1: 5-wire RS485, COM2: 5-wire RS232/TTL, COM3/4/5: 3-wire RS232/TTL)
- 2 USB Host and 1 USB Device
- 1-channel CAN2.0 bus
- 4-channel 10-bit ADC
- Two 10/100M Ethernet ports
- CF card slot
- 20-pin JTAG interface
- Battery backed RTC
- Mini-PCI interface (SDIO, SPI, COM2 and USB Host are led out through this interface)
- LEDs
- Buzzer
- Reset button
- Watchdog timer
- 8 GPIOs (can be used as 4*4 keyboard or independent Ios)
- Supports Linux 2.6

SBC2416-I

Mini2416-I, 400MHz, 3UARTs,
DDR2 SDRAM, SD bootable

Features

- 103mm*137mm (expansion board)
65mm*45mm (CPU board Mini2416-I)
- Working Temp.: 0~70 Celsius
- Power supply: +5V
- Processor: Samsung S3C2416X
- 64MB DDR2 SDRAM
- 128MB Nand Flash (bootable)
- 3 Serial ports (COM0: five-wire RS232,
COM1/COM2: two three-wire RS232)
- USB Host and USB Device
- 10/100M Ethernet port
- LCD interface
- Touch Screen interface
- Audio input and output ports
- 20-pin JTAG interface
- Battery backed RTC
- SD card slot (bootable)
- 4 LEDs
- 6 Buttons
- Supports WinCE5.0

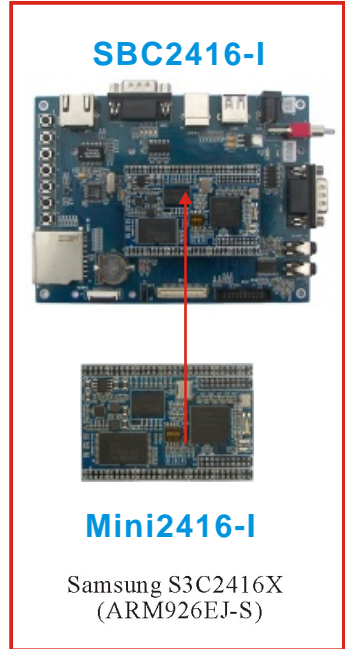

SBC2440-III

Mini2440-I, 400MHz, 3UARTs,
LCD,USB, NET, Audio, SD

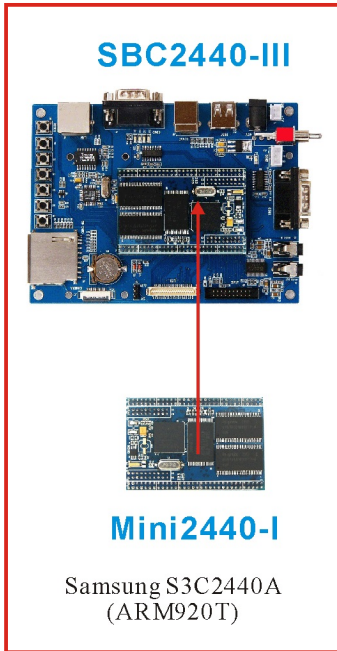

Features

- 103mm*137mm (expansion board)
- 65mm*45mm (CPU board Mini2440-I)
- Working Temp.: 0~70 Celsius
- Power supply: +5V
- Processor: Samsung S3C2440A
- 64MB SDRAM
- 128MB Nand Flash
- 3 Serial ports (COM0: five-wire RS232, COM1/COM2: two three-wire RS232)
- USB Host and USB Device
- 10/100M Ethernet port
- LCD interface
- Touch Screen interface
- Camera interface
- Audio input and output ports
- 20-pin JTAG interface
- Battery backed RTC
- SD card slot
- 4 LEDs
- 6 Buttons
- Supports Linux2.6 and WinCE6.0

S3CEV40

66MHz, ARM7, USB, LCD,
Ethernet, TSP, IIS

Features

- 190mm*190mm (main board)
- Working Temp.: 0~85 Celsius
- Processor: Samsung S3C44B0x
- +5V or USB power supply
- 2MB Nor Flash
- 16MB Nand Flash
- 8MB SDRAM
- 4Kbit EEPROM with I2C bus
- 2 RS232 Serial ports
- USB Device
- 10M Ethernet port
- Microphone input
- I2S audio output (speaker output)
- IDE interface
- LCD and Touch Screen interface
- 320*240 LCD (optional)
- 4*4 Keyboard (optional)
- Reset button
- 2 interrupt buttons and 2 LEDs
- 8 segment leds
- 20-pin JTAG interface
- 4 groups 2*20-pin expansion connectors of CPU
- Supports uCos and uCLinux



Samsung S3C44B0x (ARM7TDMI)

DevKit3250 Features

- 165mm*115mm (expansion board)
75mm*55mm (CPU board Mini3250)
- Working Temp.: 0~70 Celsius
- Power supply: DC Jack, +9V~+12V DC Input, Power Pin (Optional)

DevKit3250 CPU Board (Mini3250)

- Processor: NXPLPC3250
(compatible with NXP LPC3220/LPC3230/LPC3240)
- 64MB SDRAM
- 128MB Nand Flash
- 4MB Nor Flash
- 32768Hz RTC
- Watchdog timer
- USB OTG 2.0 connector
(mini-B type, with ESD protection)
- 40-pin LCD interface with 4-wire resistive
touch screen interface
- TF card slot
- Power indicator
- Programmable LED
- JTAG on the rear of the board (optional)
- Two 2.0mm pitch 3-line 27-pin connectors (7 UARTs, Ethernet and all
IOs are led out via the two connectors.)
- Supports Linux 2.6

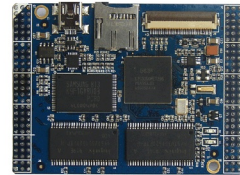

Mini3250

DevKit3250 Expansion Board

- Serial ports:
 - 4 x RS232 UARTs, DB9 Connector; optional TTL lead out with pin array
 - 4 x TTL UARTs, lead out with pin array
 - 1 x IrDA
- EMC Bus
 - 24 bit Address Bus and 16 bit Data Bus, CS, Reset, Read/Write, INT Signal
- 10/100M Ethernet port (RJ45 connector with LED)
- I2C Type 2Kbit EEPROM
- Reset button
- 4 Programmable buttons connecting with pin array
- 3 ADC Phoenix Terminal Interfaces
- 3.5mm Stereo Phone Jack
- 3.5mm Mic Jack
- 20-pin 2.54mm pitch JTAG interface
- 23 IO Pins, including I2C, SPI, PWM etc.
- RTC with Lithium Battery CR2032
- Buzzer
- Power indicating LED
- Supports Linux2.6

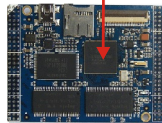

Mini3250

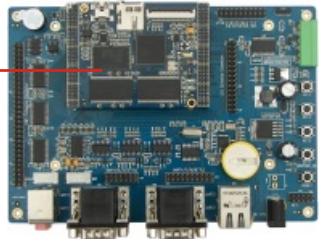

DevKit3250

NXP LPC3250 (ARM926EJ-S)

Features



- TI OMAP3530DCUS (600MHz ARM Cortex-A8 & 412MHz TMS320C64x DSP core)
- 256MB DDR SDRAM
- 256MB Nand Flash
- Supports up to 32GByte Micro SD (TF) card storage
- Power Supply: DC5V/2A or 5000mAH lithium battery
- 7-inch LCD display (Resolution: 800*480 pixel)
- 4-lines resistive touchscreen
- WiFi (WLAN 802.11b/g)
- Bluetooth (V2.1, EDR+, A2DP bluetooth stereo, support stereo earphone)
- GPS (SiRF III)
- 1.3Mega pixel CMOS Camera (Resolution: 1280*1024 pixel)
- Audio output port
- 2 speakers (Stereo, 0.5W +0.5W)
- Mic in (built-in, support recording)
- G-Sensor
- 3G Function (Optional USB Module or Mini-PCIe Module)
- Keys (Power, ESC, Tracking Ball, User Key 1, User Key 2, Reset)
- Supports Android2.1 and WinCE6.0



HMI Solution

TH104A1, 400MHz,
10.4-inch LCD, 4UARTs,
NET, USB, CAN, SD

Features

- Working Temp.: -10~70 Celsius
- Atmel AT91SAM9G45 ARM926EJ-S core
- Power supply: 24V DC In
- 128MB DDR2 SDRAM
- 256MB Nand Flash
- 4 Serial ports (COM1:5-wire RS232, COM2: 3-wire RS232, COM3: 3-wire RS232/RS485 with power and signal isolation, COM4: 3-wire RS485)
- 2 High-speed USB2.0 Host ports
- 10M/100M Ethernet port (RJ45 with LED)
- CAN2.0 interface (with power and signal isolation)
- 10.4-inch LCD (Resolution: 800x600 pixel, with touch screen)
- SD card slot
- Battery backed RTC
- 2 Status LEDs
- Support Linux2.6

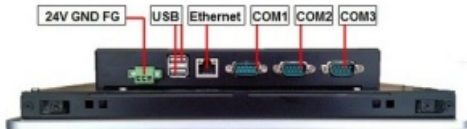



Features

- Working Temp.: 0~70 Celsius
- Samsung S3C2440A ARM920T core
- Power supply: 24V DC In
- 64MB SDRAM
- 128MB Nand Flash
- 3 RS232 serial ports (COM2: DB9 male connector, two RS232 with isolation, one with flow control, COM3: DB9 female connector, one RS232 with isolation)
- 2 RS485 serial ports (COM3: DB9 female connector, two RS485 with isolation, one is two-wire and another is four-wire)
- USB Host and USB Device
- 10/100M Ethernet port (RJ45 with LED and isolation)
- SD card slot
- 7-inch LCD (Resolution: 800x480 pixel, with touch screen)
- Battery backed RTC
- Status LED
- Supports WinCE5.0

Features

- Working Temp.: -10~70 Celsius
- Atmel AT91SAM9G45 ARM926EJ-S core
- Power supply: 24V DC In
- 128MB DDR2 SDRAM
- 256MB NAND Flash
- 2 Serial ports (COM1: 5-wire RS232, COM3: 3-wire RS232/RS485)
- 2 High-speed USB2.0 Host ports
- 10/100M Ethernet port (RJ45 with LED)
- 5.6-inch LCD (Resolution: 640x480 pixel, with touch screen)
- Battery backed RTC
- 2 Status LEDs
- Supports Linux2.6



Video Solution

VSS3530
600MHz, Audio,
Video, NET, USB



Features

- Case size: 76.1mm*120.4mm
- Input power: +12V
- Working Temp.: 0 ~ 70 Celsius
- TI OMAP3530 (ARMCortex-A8 & 412MHz TMS320C64x DSP core)
- 128MByte 32-bit DDR SDRAM, 166MHz
- 128MByte 16-bit NAND Flash
- AV video output interface
- 2 AV audio output interfaces
- BNC analog camera interface
- High-definition HDMI (DVI-D) video output interface
- MIC audio input interface
- 10/100M extended Ethernet interface, RJ45 connector
- Power supply interface
- High-speed USB2.0 Host port
- TF card slot
- Supports WiFi and 3G functions through optional USB modules
- Supports Linux 2.6

USB Oscilloscope

DSO2300,
100Ms/s, 2-ch

Features

- Size: 144mm x 88mm x 38mm (excluding cable and probes)
- Weight: <0.35kg (excluding accessories)
- Sampling Rates: 100Ms/s
- USB power supply
- 3 Trigger styles: Rising Edge, Lever and Falling Edge
- On-line auto calibration
- Record and play: not only current waveform but also continuous waveform can be recorded as .jpg file.
- Easy operation: a point-and-click software interface with active cursors
- 1KHz square wave demonstration signal
- Displayed location and color can be adjusted.
- USB2.0 full speed port
- Spectrum Analyzer / FFT
- Waveform is able to printed on-line to printer
- XY-Plot / CMap / SMap
- Data can be stored in Excel, Word or Notepad
- Simple logic analyzer: capable of analyzing logic relationship and serial signal between two channels.
- Automatical searching and tracing function
- Easy installation: run directly from .exe file



DSO2300 USB Oscilloscope

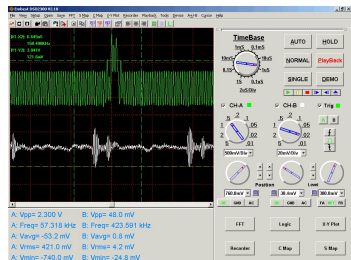

DSO2300 Software Interface

Jtag Emulator

UNetICE
USB&Ethernet
200~800KB/s



Embest UNetICE for ARM is the new-generation high-speed real time Jtag emulator made by Embest. UNetICE connects the PC USB port or Ethernet port to the JTAG interface of target board and allows Flash programming and debugging. UNetICE allows you to:

- Downloading codes to target
- Examine memory and registers.
- Single-step through programs.
- Insert multiple breakpoints.
- Run programs in real-time.
- Program on-chip Flash.

Features

- Supports microcontrollers based on ARM7 and ARM9.
- Supports Windows98/NT/2000/ME/XPhost.
- Supports standard 20-pin JTAG port connecting to target.
- Supports two hardware breakpoints/two data breakpoints/unlimited software. breakpoints(in fact this is determined by ARM core).
- Supports 10/100M Ethernet port or USB port connecting to host PC.
- Supports Embest IDE, ARM/ADS, ARM/SDT and GDB.
- Fast downloading and debugging speed up to 200 ~ 800KBytes/s.
- Supports network sharing among development team and remote debugging.
- Supports both USB and Ethernet power supply.
- Capable of updating firmware.

Jtag Emulator

XDS100v2
USB2.0
For TI Processors



The XDS100v2 USB JTAG Emulator is the second release of the XDS100 JTAG emulator technology supporting debug of a variety of TI devices. It allows the user direct access between the host computer and the DSP through a 14-pin JTAG header. It is compatible with Code Composer Studio (CCS) V4 IDE from Texas Instruments and compatible with Windows 2000/XP/Vista.

Features

- Supports for the following processor cores: TMS320C28x, TMS320C54x, TMS320C55x, TMS320C64x+, TMS320C674x, ARM 9, ARM Cortex R4, and ARM Cortex A8.
- Supports targets with 14-pin TI JTAG connector as used by Texas Instruments embedded processors.
- USB bus powered
- Supports for USB2.0 High Speed (480 Mbit/s)
- Compatible with +1.8V or +3.3V JTAG interfaces
- Supports for Code Composer Studio v4 and newer (Does not support Code Composer Studio v3.3)
- Supports Code Composer Studio C2000 On-Chip Flash Programmer. Compatible with Windows 2000, XP, and Vista.

Embest IDE for ARM

Embest IDE for ARM provides comprehensive, professional software tools for building embedded applications. These software kits provide a modern 32-bit Windows-based C Integrated Development Environment (IDE) that hosts the entire development process in one location (available for Windows 98/NT/2000/ME/XP). The IDE consists of:

- A modern editor with syntax highlighting, menu navigation, error indicating, batch searches.
- A project Manager for tracking build dependencies and managing source files in large projects.
- Integrated GNU compiler/assembler/linker.
- Remote debugger integrated with the editor: watch windows, dynamic expression evaluation, conditional breakpoints.
- An ARM instruction set simulator
- Tools for Flash programming/ disassemble/ elf to bin/split bin



Features

- Supports all ARM processors based on ARM7 and ARM9.
- Provides with Embest Jtag compatible In-circuit Emulator.
- Integrated GNU compiler, also supports ARM/SDT compiler.
- Capable of opening and debugging project made in ADS and SDT.
- Capable of reading/editing Peripheral register.
- Plenty of examples for microcontroller from Atmel, NXP, ST, Samsung, CirrusLogic, Etc.
- Allows license share in a LAN working Environment.

Flash Programmer

Embest Flash Programmer is a powerful tool for downloading codes to ARM7/9 target board via JTAG port. It can be released as a powerful tool for Embest IDE for ARM package, it also can be released as an individual tool for customers used for programming on-board flash chip. This software must be applied together with ARM emulator made by Embest or a JTAG cable made by yourself. When purchase this tool individually, you should make a JTAG cable by yourself or buy an Embest Jtag emulator (PowerICE or UNeTICE).

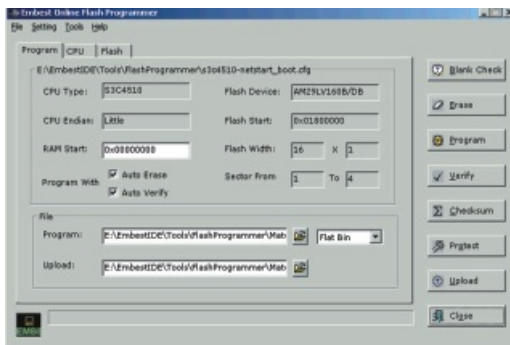

Features

- Supports all ARM7 and ARM9 microcontrollers.
- Supports programming almost all the manufacturers' flash chips.
- Customer can add new flash chips into the software easily by himself.
- Also Supports on-chip flash programming for LPC2000 series, AT91SAM7 series, STR710F series.
- Capable of blank checking, erasing, programming, file verifying, calculating check sum, protection, uploading codes.
- Capable of designated sector operation without influencing other sector
- Access flash chip data width of 8-bit, 16-bit and 32-bit
- Capable of 1-chip, 2-chips and 4- chips Flash Programming without splitting Codes File.
- Available for Windows 98/NT/2000/ME/ XP

For flash chip programming based on ARM processors

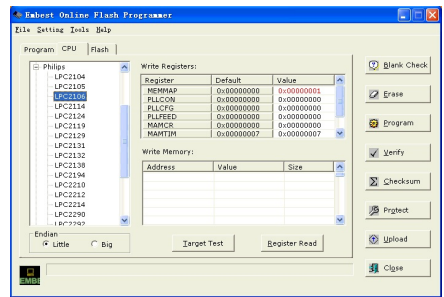
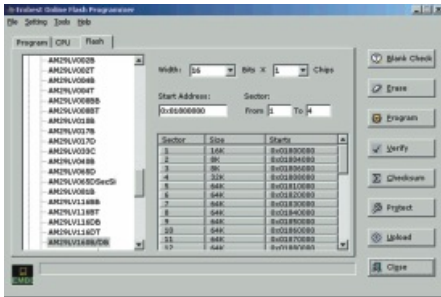

Make Jtag Cable by Yourself (Jtag Cable Schematic)

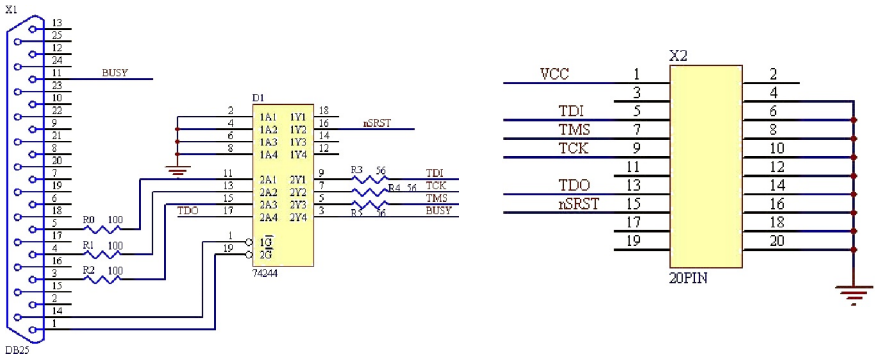

Educational Kits

EmbestUniversity[®]

EmbestUniversity[®] is a full package for laboratory exercises focused on embedded system development, including evaluation boards, development tools, laboratory exercises codes and teaching materials. It is just ready for teaching aids for universities and other educational institutes. It can be used as a lab teaching platform solution for embedded and real-time embedded systems at undergraduate or graduate level with majors in Computer Science, Computer Engineering, Automation Control, Electrical Engineering or for professional engineers. University courses which focus on computer architecture, embedded systems development or general programming can benefit from using EmbestUniversity[®]. Students will use up-to-date tools and technology.



Hardware + Software + Courseware

Embest is an ARMATC (Approved Training Center) in China. EmbestUniversity[®] is a professional education kit for ATC courses. It is used by many universities and colleges both in China and international and has got perfect effect.

Evaluation board

The recommended evaluation board in EmbestUniversity[®] package is Embest S3CEV40 board, which is based on Samsung S3C44B0X 16/32-bit RISC microcontroller (ARM7TDMI). Many laboratory exercises codes with teaching materials are provided with this board. Furthermore, we also have uC/OS-II and uLinux porting on this board. It is really convenient for teachers and helpful for students.

Other evaluation boards from e.g. NXP, Atmel and ST Microsystems are available as well. We provide plenty of sample codes with all of these boards, but the teaching material is based on the S3CEV40 board.

Development tools

The recommended development tool in EmbestUniversity[®] package is Embest IDE for ARM development tools suite I. Embest IDE for ARM tools suite includes IDE, editor, compiler & linker, debugger, project manager, JTAG emulator, flash programmer and other tools. It is a complete tools solution for embedded system development based on ARM. Embest IDE for ARM tools are easy enough to be used in both graduate and undergraduate programs. Embest IDE is a high-performance, robust product. It provides strong features for debugging, editing and project management.

Teaching materials

Embest provides complete teaching materials with EmbestUniversity[®] package, including laboratory exercise codes, user manuals of boards and tools, laboratory exercises book, etc.

The laboratory exercises book is named "Embedded System Development and Labs". This book is based on the Embest S3CEV40 board. The Labs include five parts:

1. basic labs for embedded development
2. basic device interfacing labs
3. complex human-machine interfacing labs
4. communication and voice interface labs
5. embedded RTOS porting and application development



These five parts have 22 Labs in total. The labs increase in their difficulty as the book progresses through more materials. The labs are very practical and target real world applications. The readers can quickly master the skills that are needed to develop real projects. The purpose of this book is to develop the students' creation ability, design ability, real world engineering project development ability. This lab manual can be used as a reference book for embedded system development based on ARM. We provide this book in PDF file on CD.

Customer Design Service

Embest's ultimate commitment is in helping customers develop their application successfully. Our success is intertwined with the success of your project. The embedded development tools make this task easier, but there can still be a substantial learning curve involved in developing embedded applications for a new platform; even quick application prototyping can be a frustrating experience.

For those most interested in getting started quickly in the development of their applications, Embest now offers professional custom software development and board design. Engineers at Embest and our partners have accumulated thousands of hours worth of experience developing applications for use on microcontrollers, and you can leverage our experience to increase your own productivity.

We will work with you to develop an initial application specification (including microcontroller selection). Based on this specification, our engineers will implement a prototype of the application. The fully commented source code and a working hardware demonstration is provided to you once we complete development. Our focus is on making the code reliable and easily modifiable to fit your changing application needs over time. We will provide support to make sure the deliverables can be integrated into your system successfully.

Embest provide cost effective and quality custom design services including:

Hardware Development

We provide hardware development services covering the entire value chain:

- Specification
- Schematic entry
- board designs for many microcontrollers and microprocessors
- PCB layout
- Realisation of a low production price
- Fast prototyping
- Function and system test
- Transfer to mass production

Customer Design Service

Software Development

We provide embedded software design from designing small micro-controller based systems and large real-time, multi-tasking software systems to developing board support packages and device drivers. Designs are typically implemented using an appropriate programming language such as C, C++ and Assembler on target platforms.

- Implementation of protocol stacks
- Real-time, Multi-tasking software systems
 - Install UC-OS/II, ucLinux, Embedded Linux or Windows CE to different targets
 - Run the application based on many real time operating systems.
- Board support packages and device drivers like:
 - Ethernet/WiFi/Bluetooth/RFID/GPS/GPRS drivers
 - Serial communication drivers
 - USB drivers
 - LCD and Touch Screen drivers
 - SMC/MMC/SD card interface drivers and flash file systems
 - IDE hard disk interface drivers
- boot start codes
- Individual Linux toolchain setups
- Application development

Turnkey-Designs with optional Production Service

The delivery of our turnkey design service is an out-of-the-box mass production-ready hardware platform including a scalable production test. Optional we provide production service from low volume up to very high quantities for competitive prices.

Successful Cases

Embest have completed many projects in various applications like Bus Control Terminal, Metro Smart Card Control Board, Dive Computer and some other areas like automotive, consumer electronics, wireless networking, industrial control and etc.



Multi-Media Player
Main Board



Dive Computer



RF Cards Intelligent Water
Meter Control Board



Embest Info & Tech Co., Ltd.
Rm 509, Luohu Science&Technology Bldg.,
#85 Taining Rd., Shenzhen, Guangdong,
China (518020)
TEL: +86-755-25635656
FAX: +86-755-25616057
Email: market@embedinfo.com
Website: <http://www.embedinfo.com/english>
<http://www.armkits.com>

Local Sales Representative

