

# Type-C

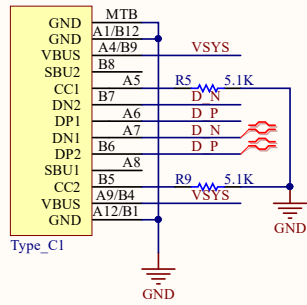

# Power

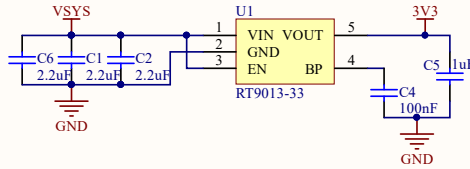

# RGB

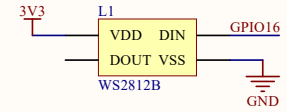

# RP2040

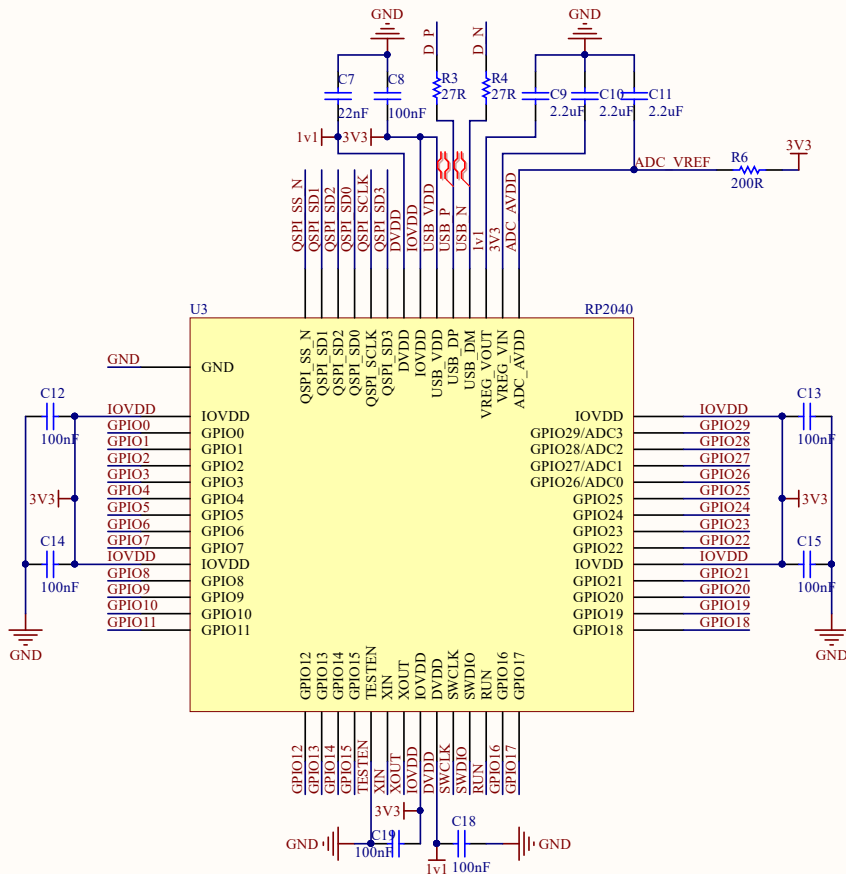

# Key

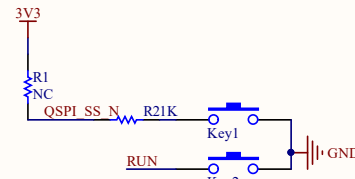

# Flash

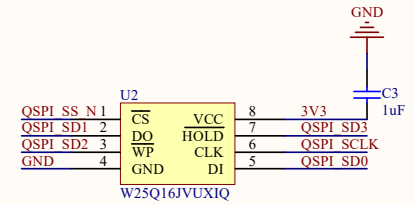

# RP2040\_Zero



# XTAL

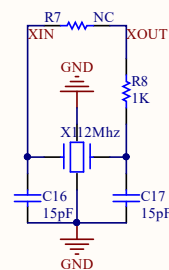

# Pin Out

