

**FEATURES**

- Low Noise Output LDO: 40 $\mu$ V<sub>RMS</sub> Possible
- 1% Initial Accuracy
- Very Low Quiescent Current: 70 $\mu$ A
- Low Dropout Voltage (210mV at 150mA)
- Current and Thermal Limiting
- Reverse-Battery Protection
- Wide Range of Fix Output Voltages: 1.2V, 1.8V, 2.5V, 3.0V, 3.3V and 5.0V
- Zero Off-Mode Current
- Small 5-Pin SOT-23
- Pin Compatible to MIC5205/MAX8877 (fixed Options Only) and LP2985

Fixed Output Voltage

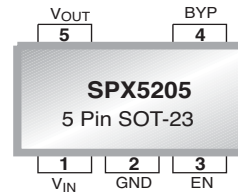

Adjustable Output Voltage

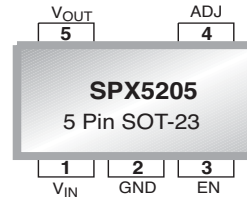

**APPLICATIONS**

- PDA
- Battery Powered Systems
- Cellular Phone
- Cordless Telephones
- Radio Control Systems
- Laptop, Palmtop, and Notebook Computers

*Now Available in Lead Free Packaging*

- Portable Consumer Equipment
- Portable Instrumentation
- Bar Code Scanners
- SMPS Post-Regulator

**DESCRIPTION**

The SPX5205 is a positive voltage regulator with very low dropout voltage, output noise and ground current (750 $\mu$ A at 100mA).  $V_{OUT}$  has a tolerance of less than 1% and is temperature compensated. Fixed output voltages 1.2V, 1.8V, 2.5V, 2.8V, 3.0V, 3.3V, and 5.0V and an adjustable version are available in a small 5-pin SOT-23 package. Other key features include zero off-mode current, reverse battery protection, thermal shutdown and current limit. The SPX5205 is an excellent choice for use in battery-powered applications, and where power conservation is desired such as: cellular/ cordless telephones, radio control systems, and portable computers.

**TYPICAL APPLICATION CIRCUIT**

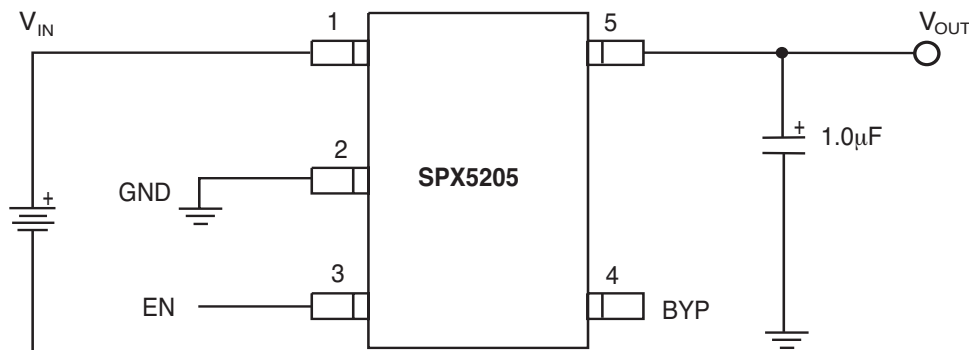

TOP View

**ABSOLUTE MAXIMUM RATINGS**

Thermal Shutdown .....	Internally Limited	Input Supply Voltage .....	-20V to +20V
Lead Temperature (Soldering, 5 seconds) .....	260°C	Enable Input Voltage .....	-20V to +20V
Operating Junction Temperature Range .....	-40°C to +125°C		

**RECOMMENDED OPERATING CONDITIONS**

Input voltage .....	+2.5V to 16V
Operating Junction Temperature Range .....	-40°C to +125°C
Enable Input Voltage .....	0V to $V_{IN}$
SOT-23-5 ( $\theta_{JA}$ ) .....	See Note 1

**ELECTRICAL CHARACTERISTICS**

$T_J=25^\circ\text{C}$ ,  $V_{IN} = V_{OUT} + 1\text{V}$ ,  $I_L = 100\mu\text{A}$ ,  $C_L = 1\mu\text{F}$ , and  $V_{ENABLE} \geq 2.4\text{V}$ . The ♦ denotes the specifications which apply over full temperature range  $-40^\circ\text{C}$  to  $+85^\circ\text{C}$ , unless otherwise specified.

PARAMETER	MIN	TYP	MAX	UNITS	CONDITIONS
Output Voltage Tolerance ( $V_{OUT}$ )	-1 -2		+1 +2	% $V_{NOM}$	♦
Output Voltage Temperature Coefficient		57		ppm/ $^\circ\text{C}$	♦
Line Regulation		0.03	0.1 0.2	%/V	♦ $V_{IN} = V_{OUT} + 1$ to 16V and $V_{EN} \leq 6\text{V}$ $V_{IN} = V_{EN} = V_{OUT} + 1 \leq 8\text{V}$
			0.2	%/V	$V_{IN} = V_{EN} = V_{OUT} + 1$ to 16V $T_a = 25^\circ\text{C}$ to $85^\circ\text{C}$
Load Regulation		0.1	0.2 0.5 1.0	%	♦ ♦ $V_{IN} = V_{OUT} + 1\text{V} \geq 2.5\text{V}$ $I_L = 1\text{mA}$ to 150mA $I_L = 100\mu\text{A}$ to 1mA
Dropout Voltage (See Note 2) ( $V_{IN} - V_O$ )		30	50 70	mV	♦ $I_L = 100\mu\text{A}$
		140	190 230	mV	♦ $I_L = 50\text{mA}$
		180	250 300	mV	♦ $I_L = 100\text{mA}$
		210	275 350	mV	♦ $I_L = 150\text{mA}$
Quiescent Current ( $I_{GND}$ )		0.05	1 5	$\mu\text{A}$	♦ $V_{ENABLE} \leq 0.4\text{V}$ $V_{ENABLE} \leq 0.25\text{V}$
Ground Pin Current ( $I_{GND}$ )		70	125 150	$\mu\text{A}$	♦ $I_L = 100\mu\text{A}$
		350	600 800		♦ $I_L = 50\text{mA}$
		750	1000 1500		♦ $I_L = 100\text{mA}$
		1300	1900 2500		♦ $I_L = 150\text{mA}$
Ripple Rejection (PSRR)		70		dB	
Current Limit ( $I_{LIMIT}$ )		360	500	mA	$V_{OUT} = 0\text{V}$
Output Noise ( $e_{NO}$ )		300		$\mu\text{V}_{RMS}$	$I_L = 10\text{mA}$ , $C_L = 1\mu\text{F}$ , $C_{IN} = 1\mu\text{F}$ (10Hz - 100kHz.)
		40		$\mu\text{V}_{RMS}$	$I_L = 10\text{mA}$ , $C_L = 10\mu\text{F}$ , $C_{BYP} = 1\mu\text{F}$ , $C_{IN} = 1\mu\text{F}$ , (10Hz - 100kHz)
Input Voltage Level Logic Low ( $V_{IL}$ )			0.4	V	OFF
Input Voltage Level Logic High ( $V_{IH}$ )	2.0				ON
ENABLE Input Current		0.01 3	2 20	$\mu\text{A}$	$V_{IL} \leq 0.4\text{V}$ $V_{IH} \geq 2.0\text{V}$

**Note 1:** The maximum allowable power dissipation is a function of maximum operating junction temperature,  $T_{J(max)}$ , the junction to ambient thermal resistance, and the ambient,  $\theta_{JA}$ , and the ambient temperature  $T_A$ . The maximum allowable power dissipation at any ambient temperature is given:  $P_{D(max)} = (T_{J(max)} - T_A)/\theta_{JA}$ , exceeding the maximum allowable power limit will result in excessive die temperature; thus, the regulator will go into thermal shutdown. The  $\theta_{JA}$  of the SPX5205 is  $220^\circ\text{C/W}$  mounted on a PC board.

**Note 2:** Not applicable to output voltages of less than 2V.

# 150mA, Low-Noise LDO Voltage Regulator

## TYPICAL PERFORMANCE CHARACTERISTICS

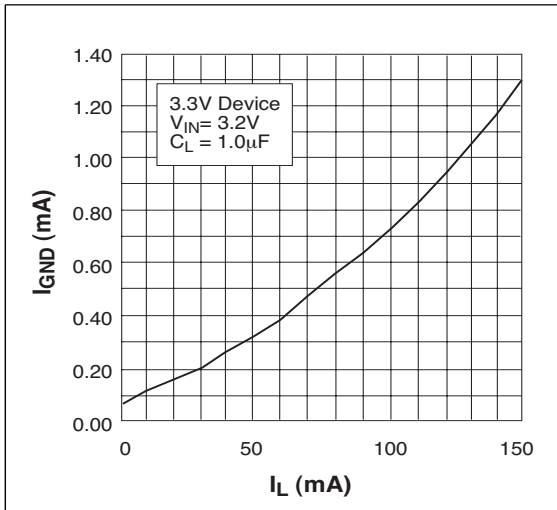

Ground Current vs Load Current

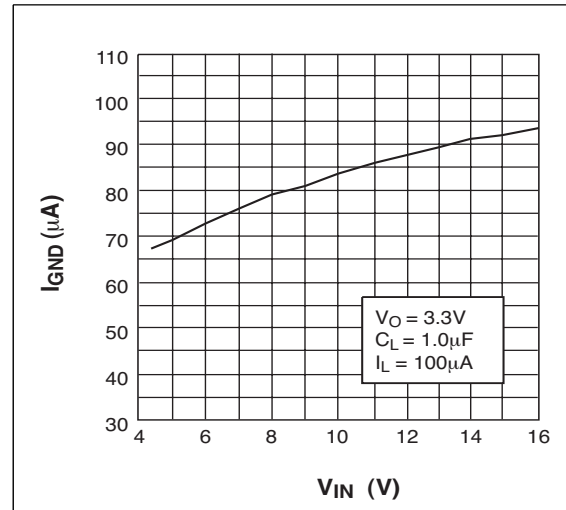

Ground Current vs Input Voltage

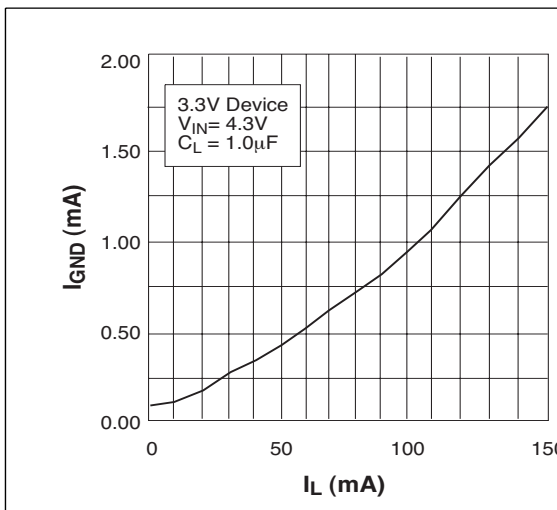

Ground Current vs Load Current in Dropout

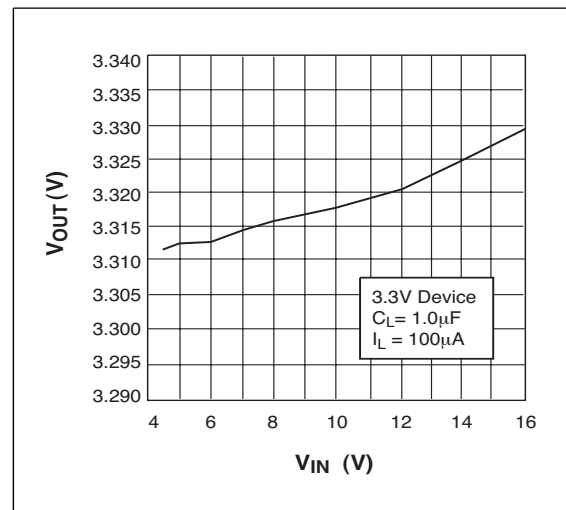

Output Voltage vs Input Voltage

TYPICAL PERFORMANCE CHARACTERISTICS

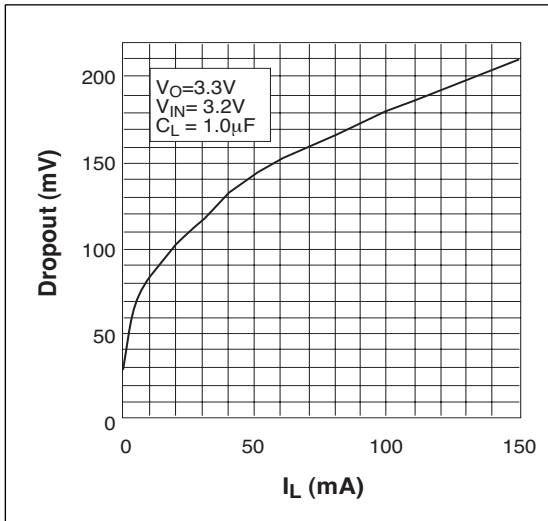

Dropout Voltage vs Load Current

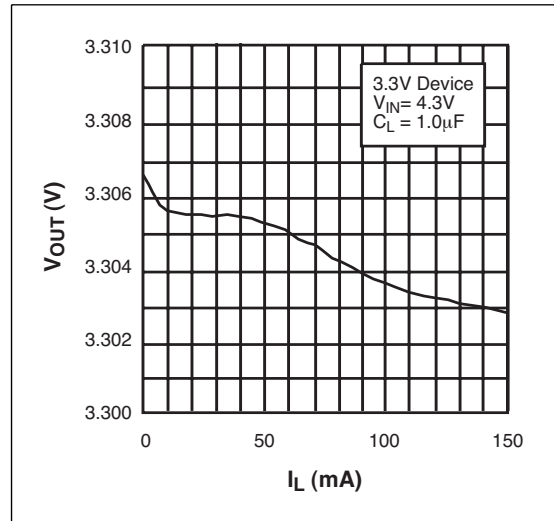

Output Voltage vs Load Current

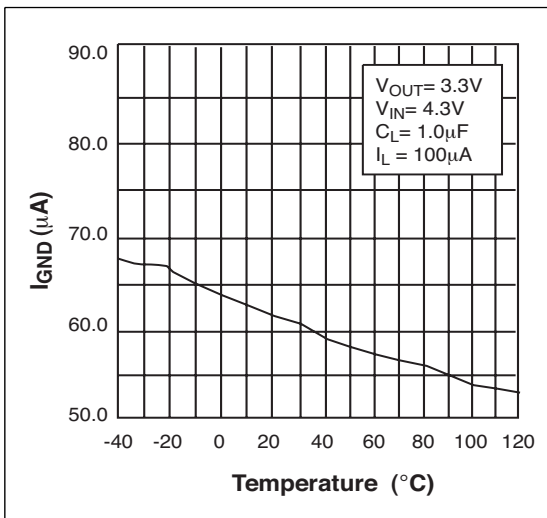

Ground Current vs Temperature at  $I_{LOAD}=100\mu A$

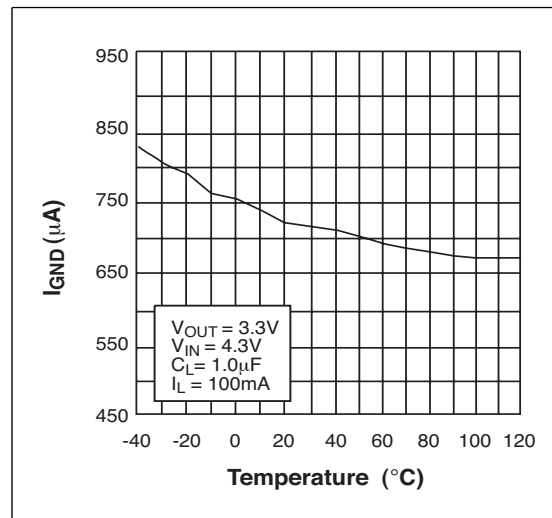

Ground Current vs Temperature at  $I_{LOAD}=100mA$

# 150mA, Low-Noise LDO Voltage Regulator

## TYPICAL PERFORMANCE CHARACTERISTICS

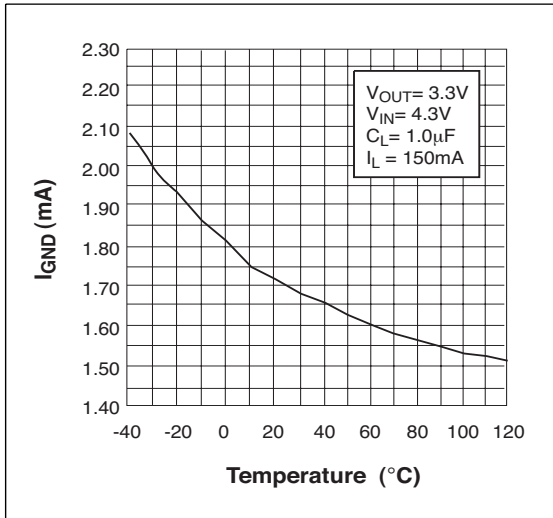

Ground Current in Dropout vs Temperature

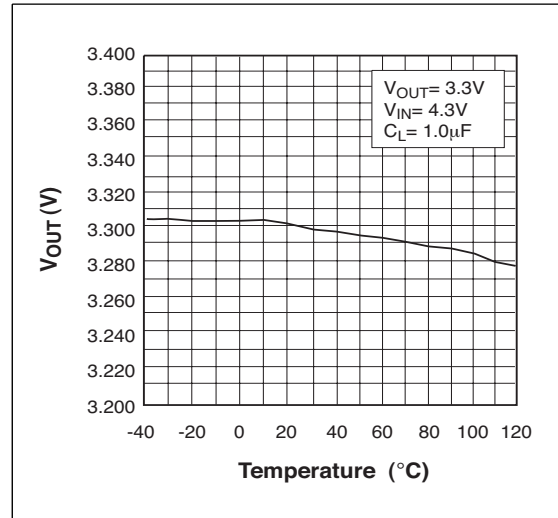

Output Voltage vs Temperature

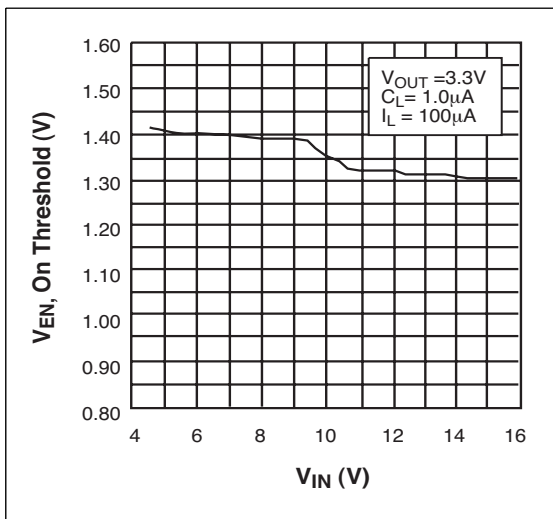

ENABLE Voltage, ON threshold vs Input Voltage

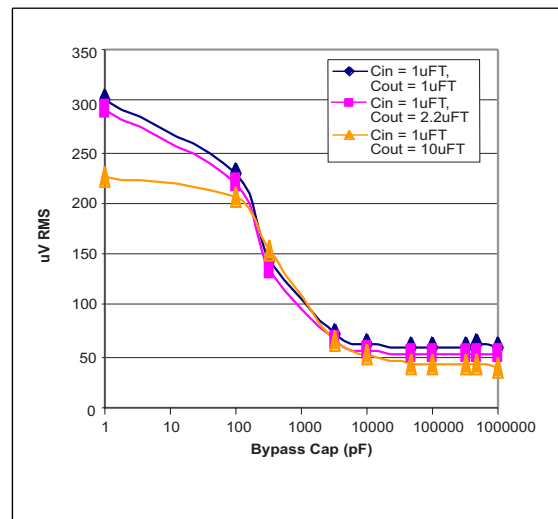

Output Noise vs. Bypass Capacitor Value

**APPLICATION INFORMATION**

The SPX5205 requires an output capacitor for device stability. Its value depends upon the application circuit. In general, linear regulator stability decreases with higher output currents. In applications where the SPX5205 is putting out less current, a lower output capacitance may be sufficient. For example, a regulator sourcing only 10mA, requires approximately half the capacitance as the same regulator sourcing 150mA.

Bench testing is the best method for determining the proper type and value of the capacitor since the high frequency characteristics of electrolytic capacitors vary widely, depending on type and manufacturer. A high quality 2.2µF aluminum electrolytic capacitor works in most application circuits, but the same stability often can be obtained with a 1µF tantalum electrolytic.

With the SPX5205 adjustable version, the minimum value of output capacitance is a function of the output voltage. The value decreases with higher output voltages, since closed loop gain is increased.

**Typical Applications Circuits**

A 10nF capacitor on BYP pin will significantly reduce output noise but it may be left unconnected if the output noise is not a major concern. The SPX5205 start-up speed is inversely pro-

portional to the size of the BYP capacitor. Applications requiring a slow ramp-up of the output voltage should use a larger C<sub>BYP</sub>. However, if a rapid turn-on is necessary, the BYP capacitor can be omitted.

The SPX5205’s internal reference is available through the BYP pin.

The Typical Application Circuit shown on page 1 represents a SPX5205 standard application circuit. The EN (enable) pin is pulled high (>2.0V) to enable the regulator. To disable the regulator, EN < 0.4V.

The SPX5205 in Figure 1 illustrates a typical adjustable output voltage configuration. Two resistors (R1 and R2) set the output voltage. The output voltage is calculated using the formula:

$$V_{OUT} = 1.235V \times (1 + R1/R2)$$

R2 must be > 10 kΩ and for best results, R2 should be between 22 kΩ and 47kΩ. A capacitor placed between adjustable and ground will provide improved noise performance.

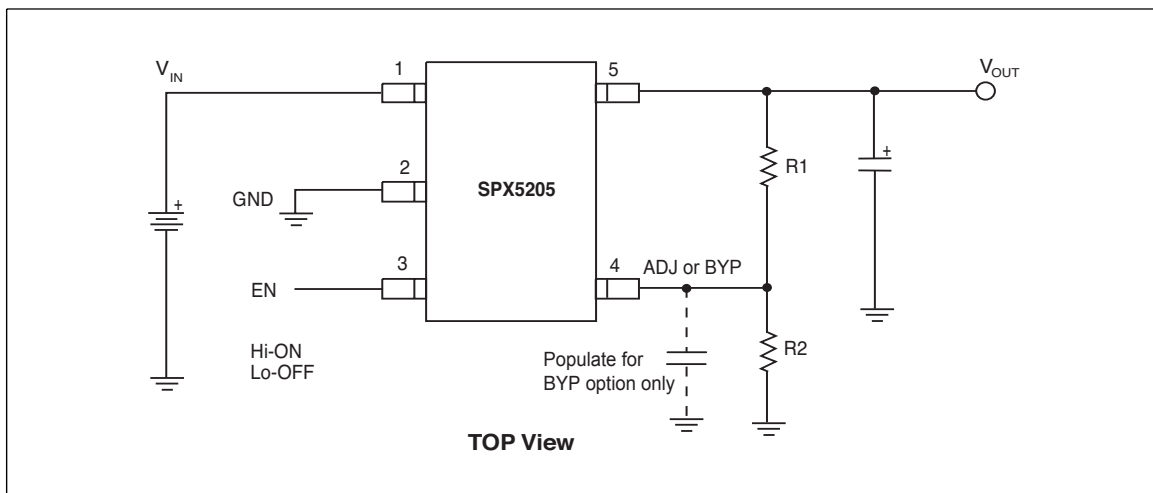

Figure 1. Typical Adjustable Output Voltage.

# 150mA, Low-Noise LDO Voltage Regulator

Top View

Side View

Front View

LAND PATTERN RECOMMENDATION

5 Pin SOT-23 JEDEC MO-178 Variation AA		DIMENSIONS IN MM (Control Unit)		DIMENSIONS IN INCH (Reference Unit)		
SYMBOLS	MIN	NOM	MAX	MIN	NOM	MAX
A	—	—	1.45	—	—	0.057
A1	0.00	—	0.15	0.000	—	0.006
A2	0.90	1.15	1.30	0.036	0.045	0.051
b	0.30	—	0.50	0.012	—	0.020
c	0.08	—	0.22	0.003	—	0.009
D	—	2.90	BSC	—	0.115	BSC
E	—	2.80	BSC	—	0.111	BSC
E1	—	1.60	BSC	—	0.063	BSC
e	—	0.95	BSC	—	0.038	BSC
e1	—	1.90	BSC	—	0.075	BSC
L	0.30	0.45	0.60	0.012	0.018	0.024
L1	—	0.60	REF	—	0.024	REF
L2	—	0.25	BSC	—	0.010	BSC
R	0.10	—	—	0.004	—	—
R1	0.10	—	0.25	0.004	—	0.010
theta	0°	4°	8°	0°	4°	8°
theta1	5°	10°	15°	5°	10°	15°
N	—	5	—	—	5	—

REV.	DESCRIPTION	DATE	APP'D
A	DRAWING ORIGINATION	10/3/05	JL
B	DRAWING FORMAT MODIFICATION	07/25/06	JL
C	ADD LAND PATTERN RECOMMENDATION	11/02/06	JL
D	CHANGE DRAWING LOGO AND COMPANY NAME	11/21/07	JL

REVISION HISTORY			
REV.	DESCRIPTION	DATE	APP'D
A	DRAWING ORIGINATION	10/3/05	JL
B	DRAWING FORMAT MODIFICATION	07/25/06	JL
C	ADD LAND PATTERN RECOMMENDATION	11/02/06	JL
D	CHANGE DRAWING LOGO AND COMPANY NAME	11/21/07	JL

**EXAR CORPORATION**

5 PIN SOT-23 PACKAGE OUTLINE

Packaging Approval: JL Date: 11/21/07

Drawing No: 5-PIN SOT-23

Revision: D Sheet: 1 OF 1



**ORDERING INFORMATION**

PART NUMBER	TOP MARK	ACC.	OUTPUT VOLTAGE	PACKAGE
SPX5205M5-L/TR	H1WW	1%	Adj	5 Pin SOT-23
SPX5205M5-L-1-2/TR	R12	1%	1.2V	5 Pin SOT-23
SPX5205M5-L-1-8/TR	DDYW	1%	1.8V	5 Pin SOT-23
SPX5205M5-L-2-5/TR	R25	1%	2.5V	5 Pin SOT-23
SPX5205M5-L-3-0/TR	R30	1%	3.0V	5 PIN SOT-23
SPX5205M5-L-3-3/TR	RCWW	1%	3.3V	5 Pin SOT-23
SPX5205M5-L-5-0/TR	SCWW	1%	5.0V	5 Pin SOT-23

All Packaging is lead free.

A bar is added to indicate lead-free parts and can be mistaken as a "1" or an "I". /TR = Tape and Reel.

Pack quantity is 3,000 for devices with top mark R12, R25, and R30. Others are 2,500 per reel

WW=Work Week

YW=Year where "6" = 2016 and Week where "A" = weeks 1 and 2, "Z" = weeks 51 and 52.

For further assistance:

Email: [customersupport@exar.com](mailto:customersupport@exar.com)  
 EXAR Technical Documentation: <http://www.exar.com/TechDoc/default.aspx?>



**Exar Corporation  
 Headquarters and  
 Sales Office**

48720 Kato Road  
 Fremont, CA 94538  
 main: 510-668-7000  
 fax: 510-668-7030

EXAR Corporation reserves the right to make changes to the products contained in this publication in order to improve design, performance or reliability. EXAR Corporation assumes no responsibility for the use of any circuits described herein, conveys no license under any patent or other right, and makes no representation that the circuits are free of patent infringement. Charts and schedules contained here in are only for illustration purposes and may vary depending upon a user's specific application. While the information in this publication has been carefully checked; no responsibility, however, is assumed for inaccuracies.

EXAR Corporation does not recommend the use of any of its products in life support applications where the failure or malfunction of the product can reasonably be expected to cause failure of the life support system or to significantly affect its safety or effectiveness. Products are not authorized for use in such applications unless EXAR Corporation receives, in writing, assurances to its satisfaction that: (a) the risk of injury or damage has been minimized; (b) the user assumes all such risks; (c) potential liability of EXAR Corporation is adequately protected under the circumstances.