



# CX1VSM CRYSTAL

10 kHz to 600 kHz

Miniature Surface Mount  
Quartz Crystal for Pierce Oscillators

## DESCRIPTION

The CX1VSM quartz crystal is a high quality tuning fork resonator for use in Pierce (single inverter) oscillators. The CX1VSM is hermetically sealed in a rugged, miniature ceramic package. The CX1VSM crystal is manufactured using the STATEK-developed photolithographic process, and was designed utilizing the experience acquired by producing millions of crystals for industrial, commercial, military and medical applications. Maximum process temperature should not exceed 260°C.

## FEATURES

- Miniature tuning fork design
- High shock resistance
- Designed for low power applications
- Compatible with hybrid or PC board packaging
- Low aging
- Full military testing available
- Ideal for battery operated applications
- Designed and manufactured in the USA

## EQUIVALENT CIRCUIT

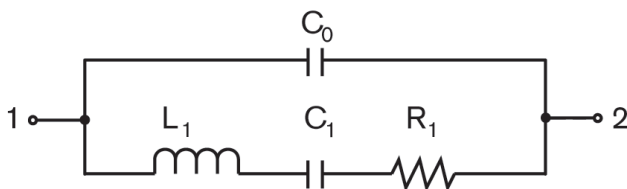

$R_1$  Motional Resistance    $L_1$  Motional Inductance  
 $C_1$  Motional Capacitance    $C_0$  Shunt Capacitance

## SUGGESTED LAND PATTERN

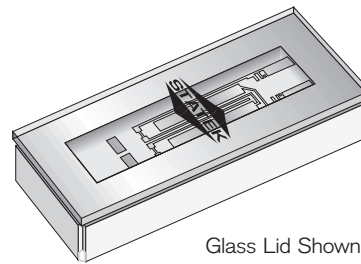
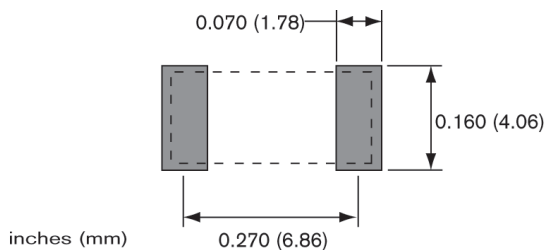

Glass Lid Shown

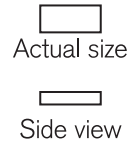

## PACKAGE DIMENSIONS

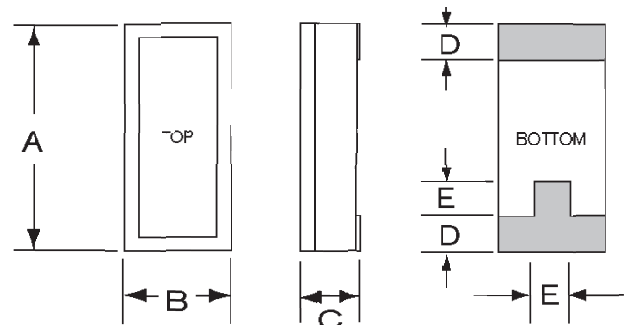

DIM	TYP.		MAX.	
	inches	mm	inches	mm
A	0.315	8.00	0.330	8.38
B	0.140	3.56	0.155	3.94
C	-	-	see below	
D	0.045	1.14	0.055	1.40
E	0.060	1.52	0.070	1.78

DIM "C"	GLASS LID		CERAMIC LID	
MAX	inches	mm	inches	mm
SM1	0.065	1.65	0.070	1.78
SM2/SM4	0.067	1.70	0.072	1.83
SM3/SM5	0.070	1.78	0.075	1.90

## CONVENTIONAL CMOS PIERCE OSCILLATOR CIRCUIT

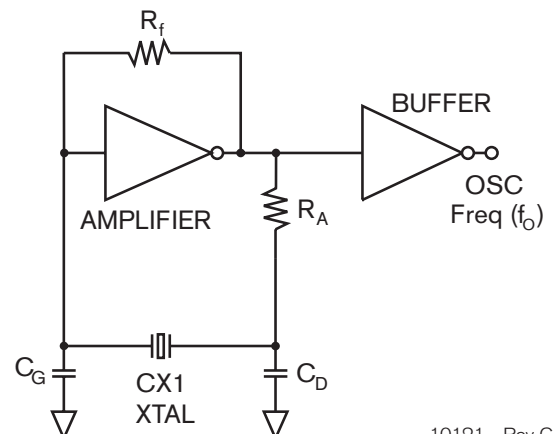

10121 - Rev C (1)



## SPECIFICATIONS

Specifications are typical at 25°C unless otherwise noted.  
Specifications are subject to change without notice.

Frequency Range	10 kHz to 600 kHz
Standard Calibration Tolerance <sup>1</sup> (see table below)	
Motional Resistance (R <sub>1</sub> )	Figure 1 MAX: 10-169.9 kHz, 2x Typ. 170-600 kHz, 2.5x Typ.
Motional Capacitance (C <sub>1</sub> )	Figure 2
Quality Factor (Q)	Figure 3 Min. is 0.25x Typ.
Shunt Capacitance (C <sub>0</sub> )	2.0 pF MAX.
Drive Level	10-24.9 kHz 0.5 μW MAX. 25-600 kHz 1.0 μW MAX.
Turning Point (T <sub>0</sub> ) <sup>2</sup>	Figure 4
Temperature Coefficient (k)	-0.035 ppm/°C <sup>2</sup>
Aging, first year	5 ppm MAX.
Shock, survival <sup>3</sup>	1,000 g, 1ms, 1/2 sine
Vibration, survival <sup>3</sup>	20 g RMS, 10-2,000 Hz
Operating Temp. Range	-10°C to +70°C (Commercial) -40°C to +85°C (Industrial) -55°C to +125°C (Military)
Storage Temp. Range	-55°C to +125°C
Max Process Temperature	260°C for 20 sec.

1. Tighter frequency calibration available.
2. Other turning point available.
3. Higher shock and vibration available.

### CX1VSM Standard Calibration Tolerance at 25°C

Frequency Range (kHz)			
10-74.9	75-169.9	170-249.9	250-600
± 30 ppm (0.003%)	± 50 ppm (0.005%)	± 100 ppm (0.01%)	±200 ppm (0.02%)
± 100 ppm (0.01%)	± 100 ppm (0.01%)	± 200 ppm (0.02%)	±500 ppm (0.05%)
± 1000 ppm (0.1%)	± 1000 ppm (0.1%)	± 2000 ppm (0.2%)	±5000 ppm (0.5%)

### Load Capacitance (C<sub>L</sub>), Used to Calibrate CX1VSM (other C<sub>L</sub> available)

Frequency Range (kHz)	Load Capacitance (pF)	Frequency Range (kHz)	Load Capacitance (pF)
10-15.9	11	55-99.9	8
16-24.9	10	100-179.9	5
25-54.9	9	180-600	4

## HOW TO ORDER CX1VSM CRYSTALS

CX1VHG \_ S \_ C SM1 - 32.768K , 30 / I

"S" if special or custom design. Blank if Std.	SM1 = Gold Plated (Lead Free) SM2 = Solder Plated SM3 = Solder Dipped SM4 = Solder Plated (Lead Free) SM5 = Solder Dipped (Lead Free)	Frequency K = kHz	Operating Temp. Range: C = -10°C to +70°C I = -40°C to +85°C M = -55°C to +125°C S = Customer Specified
Blank = Glass Lid C = Ceramic Lid	Calibration Tolerance @ 25°C (in ppm)		

FIGURE 1  
CX1V TYPICAL MOTIONAL RESISTANCE (R<sub>1</sub>)

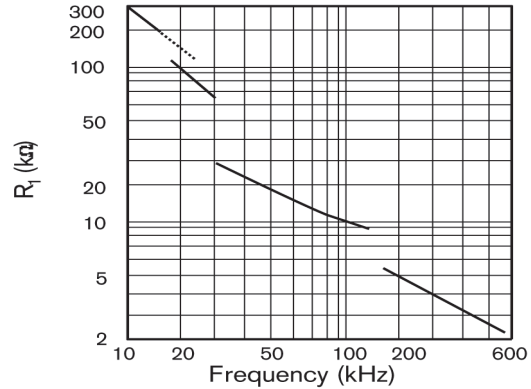

FIGURE 2  
CX1V TYPICAL MOTIONAL CAPACITANCE (C<sub>1</sub>)

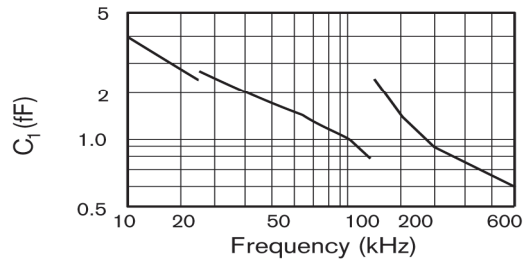

FIGURE 3  
CX1V TYPICAL QUALITY FACTOR (Q)

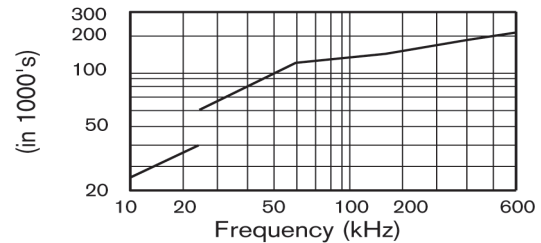
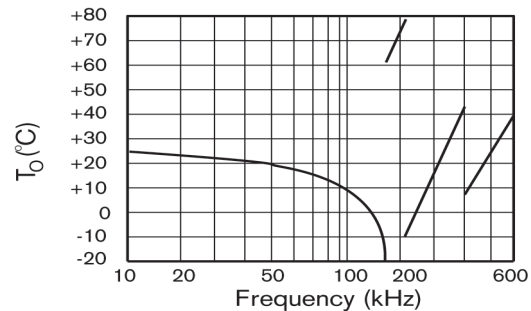

FIGURE 4  
CX1V TYPICAL TURNING POINT TEMP. (T<sub>0</sub>)



Note: Frequency f at temperature T is related to frequency f<sub>0</sub> at turning point temperature T<sub>0</sub> by:  $\frac{f-f_0}{f_0} = k(T-T_0)^2$

## TERMINATIONS

Designation	Termination
SM1	Gold Plated (Lead Free)
SM2	Solder Plated
SM3	Solder Dipped
SM4	Solder Plated (Lead Free)
SM5	Solder Dipped (Lead Free)

## PACKAGING OPTIONS

CX1VSM - Tray Pack  
- 16mm tape, 7" or 13" reels  
(Reference tape and reel data sheet 10109)

