



HJ772

PNP EPITAXIAL PLANAR TRANSISTOR

Description

The HJ772 is designed for using in output stage of 10 W audio amplifier, voltage regulator, DC-DC converter and relay driver.

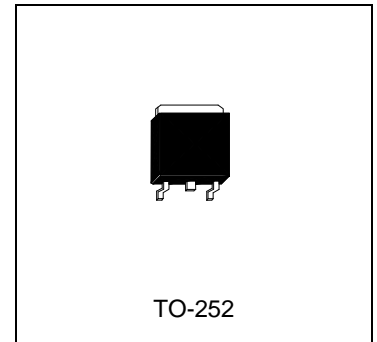

Absolute Maximum Ratings (T_A=25°C)

- Maximum Temperatures
 - Storage Temperature -55 ~ +150 °C
 - Junction Temperature +150 °C
- Maximum Power Dissipation
 - Total Power Dissipation (T_A=25°C) 1.4 W
 - Total Power Dissipation (T_C=25°C) 10 W
- Maximum Voltages and Currents
 - BV_{CBO} Collector to Base Voltage -40 V
 - BV_{CEO} Collector to Emitter Voltage -30 V
 - BV_{EBO} Emitter to Base Voltage -5 V
 - I_C Collector Current (DC) -3 A
 - I_C Collector Current (Pulse) -7 A
 - I_B Base Current (DC) -600 mA

Thermal Characteristic

Characteristic	Symbol	Max.	Unit
Thermal Resistance, junction to case	R _{θjc}	12.5	°C/W

Electrical Characteristics (T_A=25°C)

Symbol	Min.	Typ.	Max.	Unit	Test Conditions
BV _{CBO}	-40	-	-	V	I _C =-100uA, I _E =0
BV _{CEO}	-30	-	-	V	I _C =-1mA, I _B =0
BV _{EBO}	-5	-	-	V	I _E =-10uA, I _C =0
I _{CBO}	-	-	-1	uA	V _{CB} =-30V, I _E =0
I _{EBO}	-	-	-1	uA	V _{EB} =-3V, I _C =0
*V _{CE(sat)}	-	-	-0.5	V	I _C =-2A, I _B =-0.2A
*V _{BE(sat)}	-	-1	-2	V	I _C =-2A, I _B =-0.2A
*h _{FE1}	30	-	-		V _{CE} =-2V, I _C =-20mA
*h _{FE2}	100	-	500		V _{CE} =-2V, I _C =-1A
f _T	-	80	-	MHz	V _{CE} =-5V, I _C =-0.1A, f=100MHz
Cob	-	55	-	pF	V _{CB} =-10V, f=-1MHz, I _E =0

*Pulse Test: Pulse Width ≤380us, Duty Cycle≤2%

Classification Of h_{FE2}

Rank	P
Range	160-320



Characteristics Curve

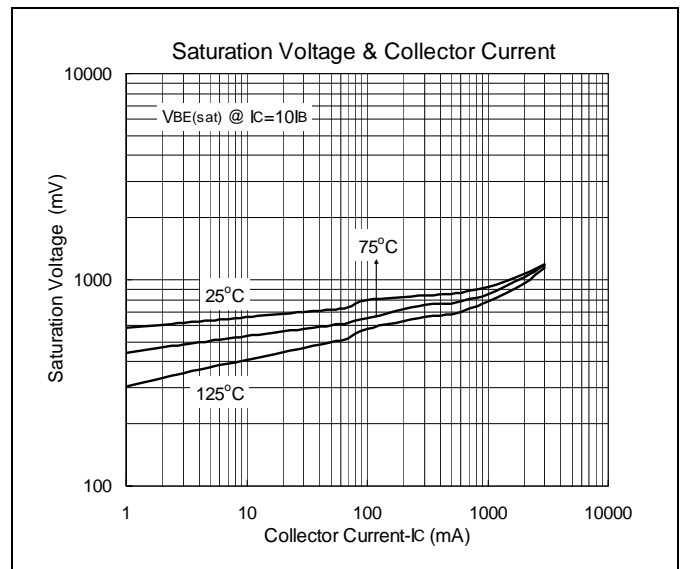
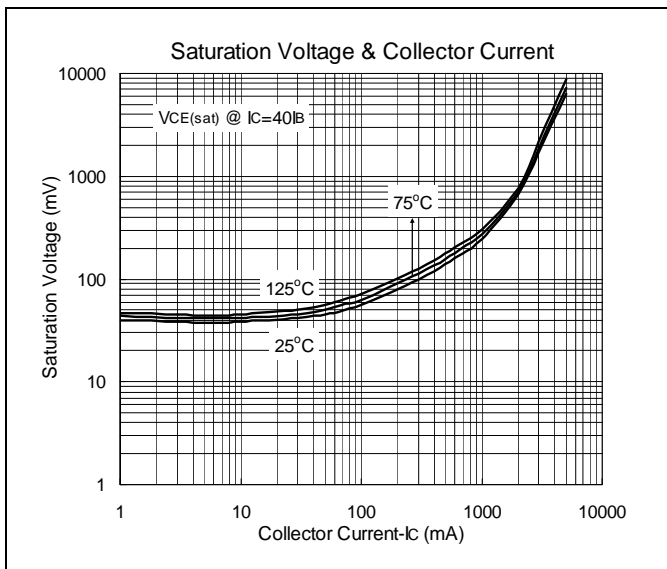
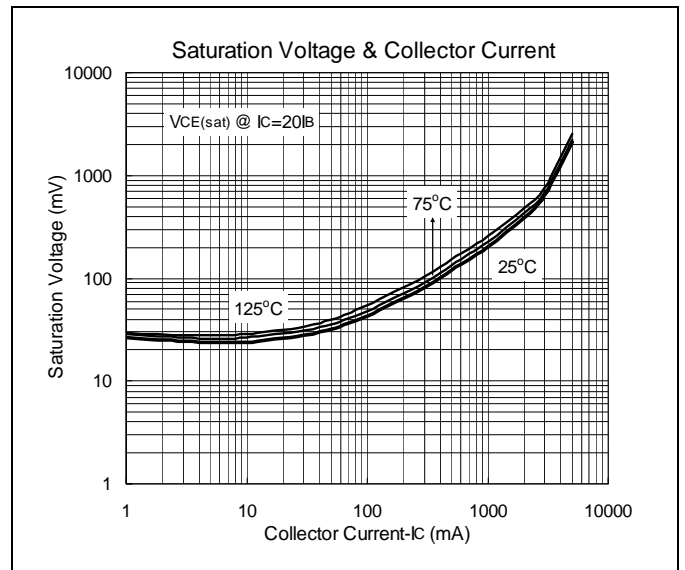
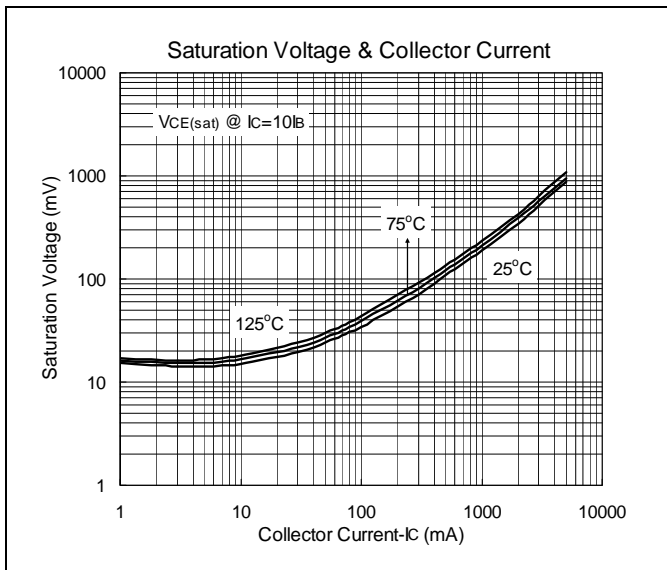
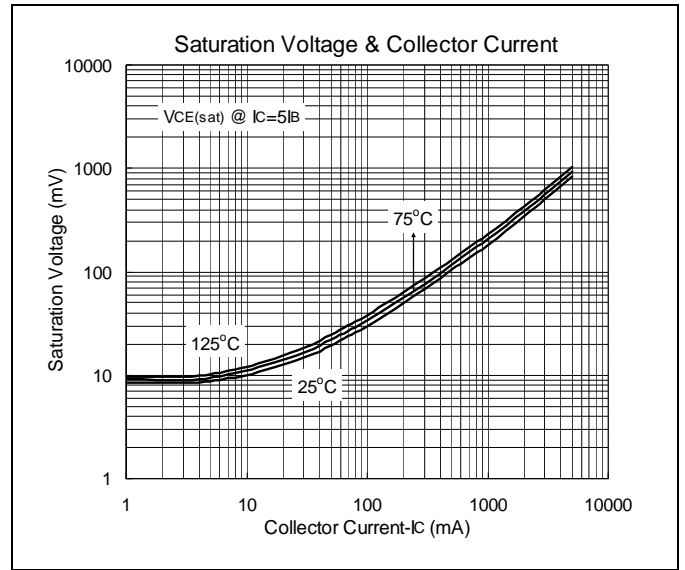
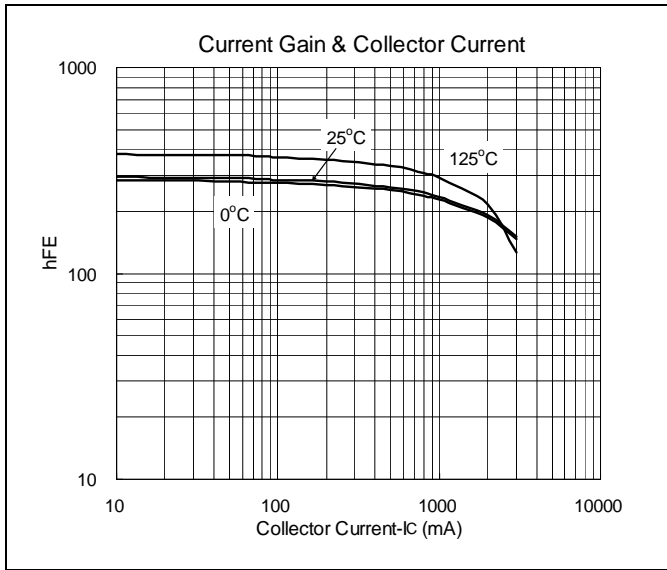

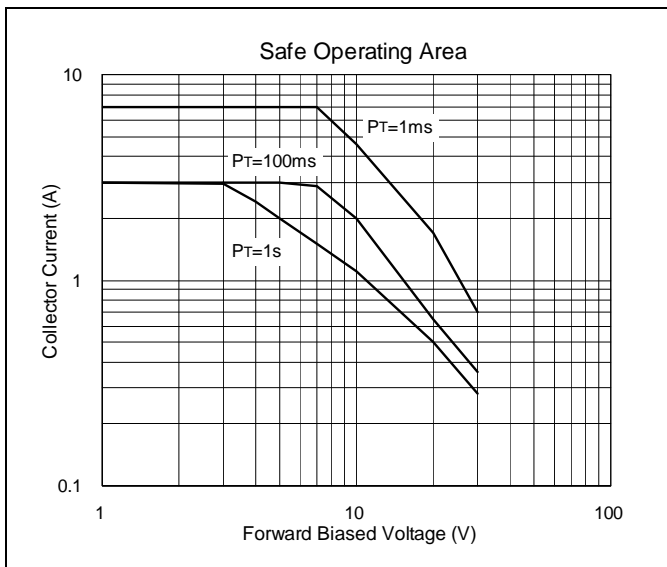
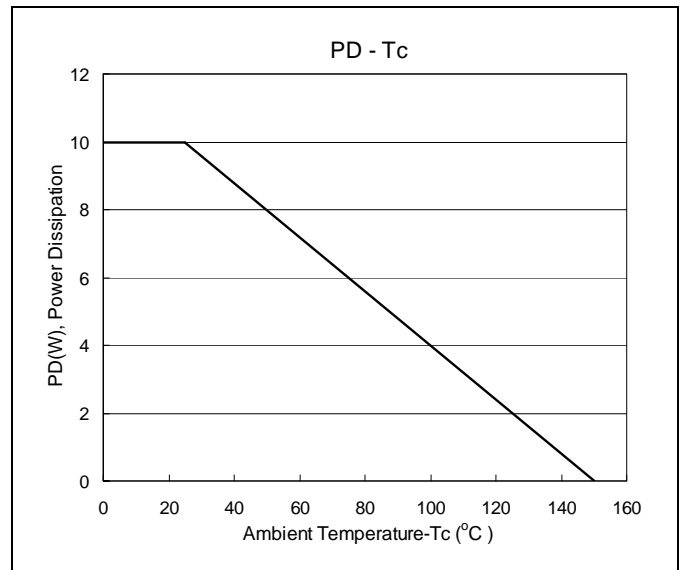
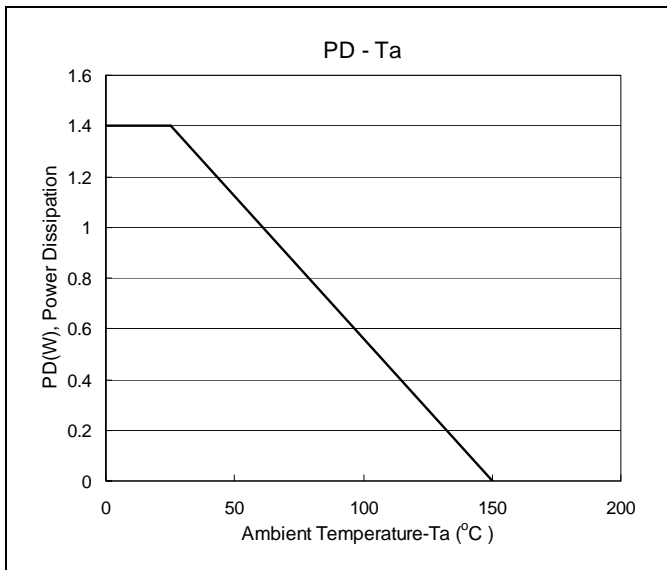
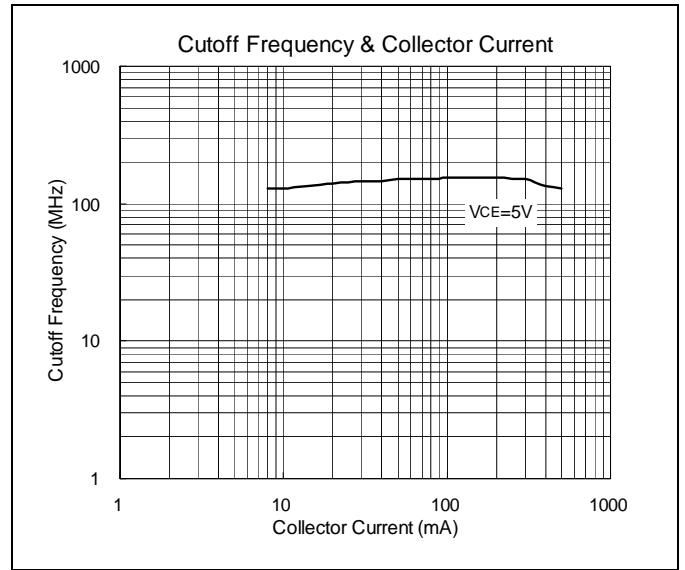
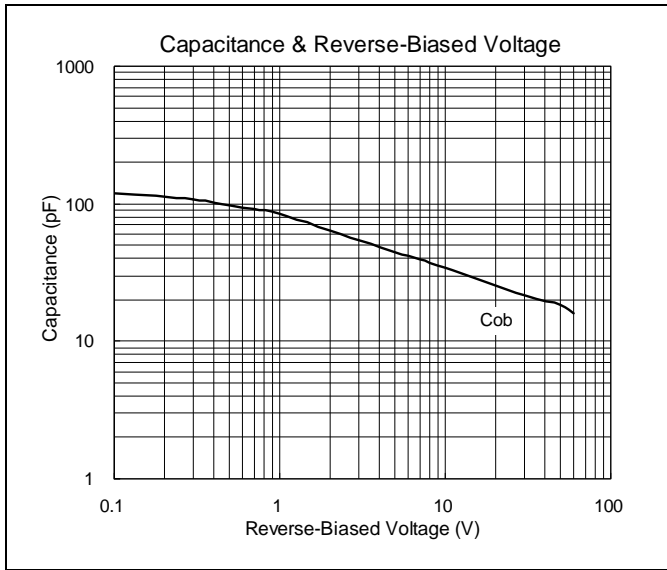



TO-252 Dimension

Marking:

Pb Free Mark
 Pb-Free: "●" (Note)
 Normal: None

Date Code Control Code

Note: Green label is used for pb-free packing
 Pin Style: 1.Base 2.Collector 3.Emitter

Material:

- Lead solder plating: Sn60/Pb40 (Normal), Sn/3.0Ag/0.5Cu or Pure-Tin (Pb-free)
- Mold Compound: Epoxy resin family, flammability solid burning class: UL94V-0

DIM	Min.	Max.
A	6.35	6.80
C	4.80	5.50
F	1.30	1.70
G	5.40	6.25
H	2.20	3.00
L	0.40	0.90
M	2.20	2.40
N	0.90	1.50
a1	0.40	0.65
a2	-	*2.30
a5	0.65	1.05

*: Typical, Unit: mm

3-Lead TO-252 Plastic
Surface Mount Package
HSMC Package Code: J

Marking:

Pb Free Mark
 Pb-Free: "●" (Note)
 Normal: None

Date Code Control Code

Note: Green label is used for pb-free packing
 Pin Style: 1.Base 2.Collector 3.Emitter

Material:

- Lead solder plating: Sn60/Pb40 (Normal), Sn/3.0Ag/0.5Cu or Pure-Tin (Pb-free)
- Mold Compound: Epoxy resin family, flammability solid burning class: UL94V-0

DIM	Min.	Max.
A	6.40	6.80
B	-	6.00
C	5.04	5.64
D	-	*4.34
E	0.40	0.80
F	0.50	0.90
G	5.90	6.30
H	2.50	3.25
I	9.11	9.80
J	0.60	1.00
K	-	0.96
L	0.55	0.86
M	2.20	2.40
N	0.70	1.10
O	0.82	1.22
a1	0.40	0.60
a2	2.10	2.50
y1	-	5°
y2	-	3°

*: Typical, Unit: mm

3-Lead TO-252 Plastic
Surface Mount Package
HSMC Package Code: J

Important Notice:

- All rights are reserved. Reproduction in whole or in part is prohibited without the prior written approval of HSMC.
- HSMC reserves the right to make changes to its products without notice.
- **HSMC semiconductor products are not warranted to be suitable for use in Life-Support Applications, or systems.**
- HSMC assumes no liability for any consequence of customer product design, infringement of patents, or application assistance.

Head Office And Factory:

- **Head Office** (Hi-Sincerity Microelectronics Corp.): 10F., No. 61, Sec. 2, Chung-Shan N. Rd. Taipei Taiwan R.O.C.
 Tel: 886-2-25212056 Fax: 886-2-25632712, 25368454
- **Factory 1:** No. 38, Kuang Fu S. Rd., Fu-Kou Hsin-Chu Industrial Park Hsin-Chu Taiwan. R.O.C
 Tel: 886-3-5983621~5 Fax: 886-3-5982931



Soldering Methods for HSMC's Products

1. Storage environment: Temperature=10°C~35°C Humidity=65%±15%
2. Reflow soldering of surface-mount devices

Figure 1: Temperature profile

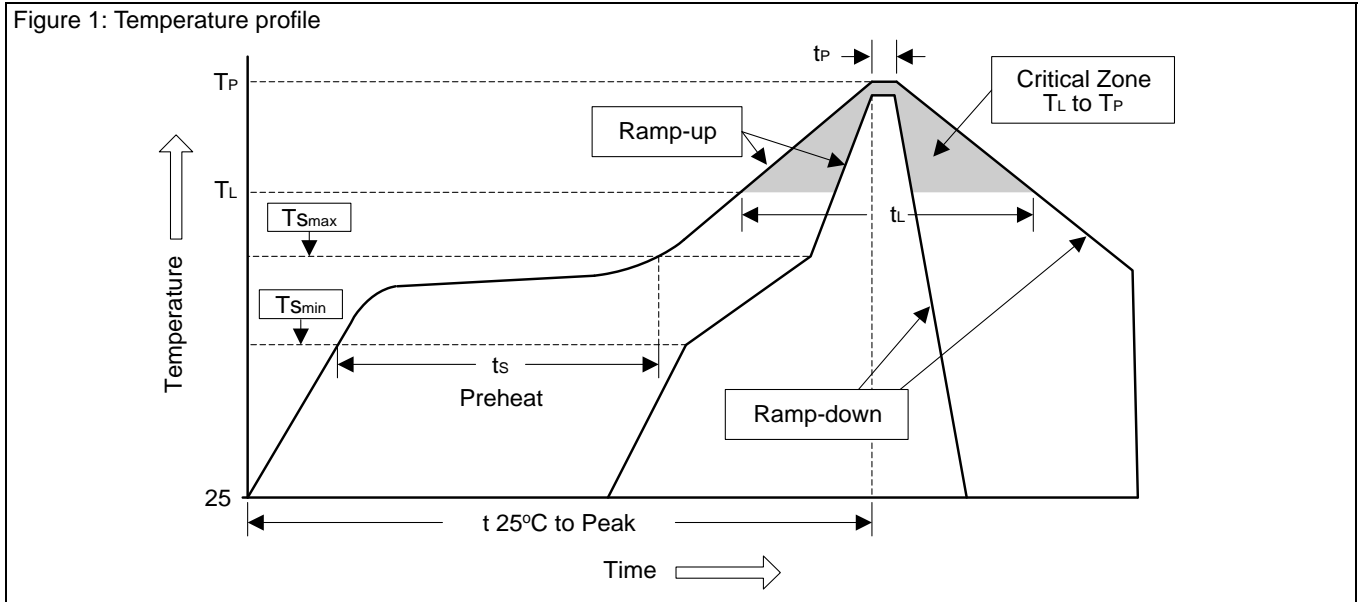

Profile Feature	Sn-Pb Eutectic Assembly	Pb-Free Assembly
Average ramp-up rate (T_L to T_P)	<3°C/sec	<3°C/sec
Preheat		
- Temperature Min (T_{Smin})	100°C	150°C
- Temperature Max (T_{Smax})	150°C	200°C
- Time (min to max) (t_s)	60~120 sec	60~180 sec
T_{Smax} to T_L		
- Ramp-up Rate	<3°C/sec	<3°C/sec
Time maintained above:		
- Temperature (T_L)	183°C	217°C
- Time (t_L)	60~150 sec	60~150 sec
Peak Temperature (T_P)	240°C +0/-5°C	260°C +0/-5°C
Time within 5°C of actual Peak Temperature (t_P)	10~30 sec	20~40 sec
Ramp-down Rate	<6°C/sec	<6°C/sec
Time 25°C to Peak Temperature	<6 minutes	<8 minutes

3. Flow (wave) soldering (solder dipping)

Products	Peak temperature	Dipping time
Pb devices.	245°C ±5°C	10sec ±1sec
Pb-Free devices.	260°C ±5°C	10sec ±1sec