

HIGH NOISE REDUCTION HIGH SPEED ANALOG OUTPUT TYPE 8 PIN PHOTOCOUPLER

DESCRIPTION

PS8602 and PS8602L is a 8-pin high speed photocopler containing a GaAIAs LED on input side and a P-N photodiode and a high speed amplifier transistor on output side on one chip. PS8602 is in a plastic DIP (Dual In-line Package). PS8602L is lead bending type (Gull wing) for surface mount.

FEATURES

- High common mode transient immunity
($OMR, OML: \pm 2000 V/\mu s$ MIN.)
- High supply voltage ($V_{CC} = 35 V$ MAX.)
- High speed response ($t_{PHL}, t_{PLH}: 0.8 \mu s$ MAX.)
- High isolation voltage ($BV: 5\,000 V_{r.m.s.}$ MIN.)
- TTL, CMOS compatible with a resistor
- Taping product number (PS8602L-E3)
- UL recognized [File No. E72422(s)]
- VDE0884 recognized: option

APPLICATIONS

- Interface circuit for various instrumentations, control equipments.
- Computer and peripheral manufactures.

ORDERING INFORMATION

PART NUMBER	PACKAGE	SAFETY STANDARD APPROVAL
PS8602	8 pin DIP	Normal specification products • UL Approved
PS8602L	8 pin DIP, lead bending type	
PS8602L1	8 pin DIP, lead bending type	
PS8602L2	(for long distance)	
PS8602-V	8 pin DIP	VDE0884 specification products (option) • VDE Approved
PS8602L-V	8 pin DIP, lead bending type	
PS8602L1-V	8 pin DIP, lead bending type	
PS8602L2-V	(for long distance)	

[Handling Precaution]

This product is weak for static electricity by designed with high speed integrated circuit. So, protect against static electricity when handling.

PACKAGE DIMENSIONS (Unit: mm)

DIP (Dual In-line Package)

Lead Bending type (Gull-wing)

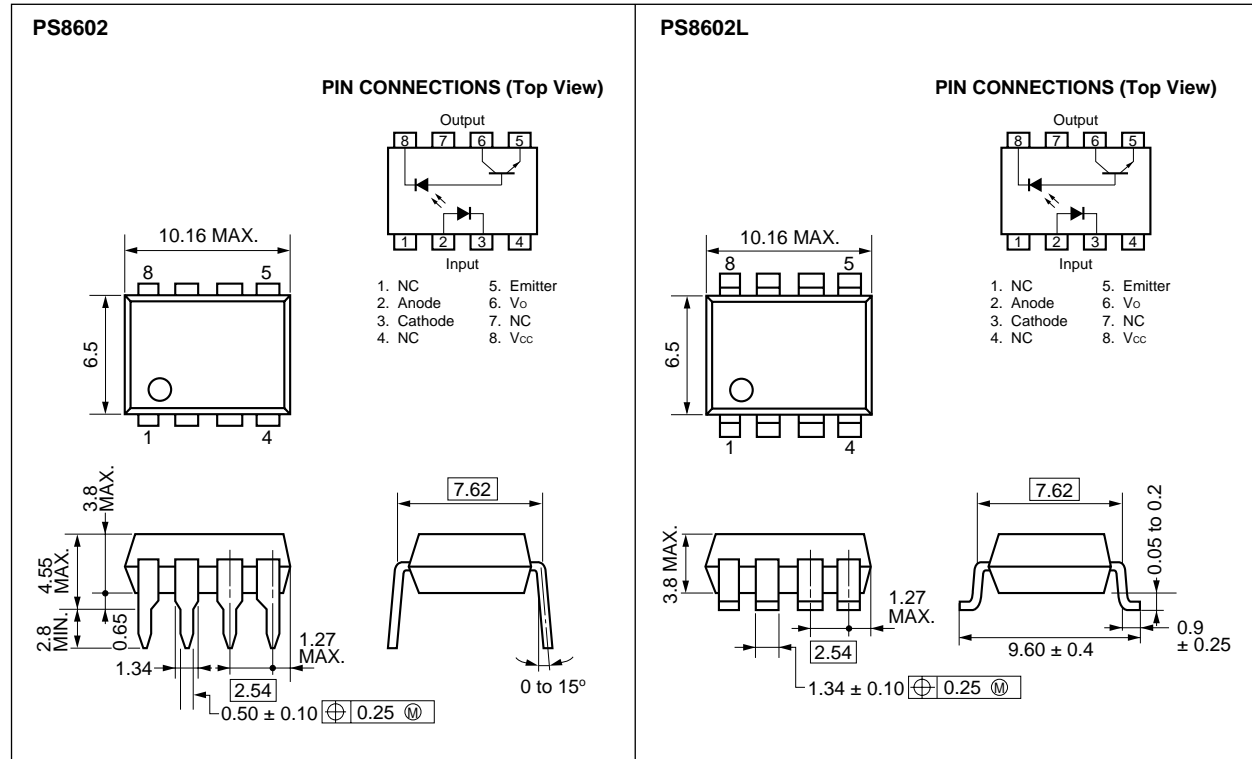

Lead Bending type (for long distance)

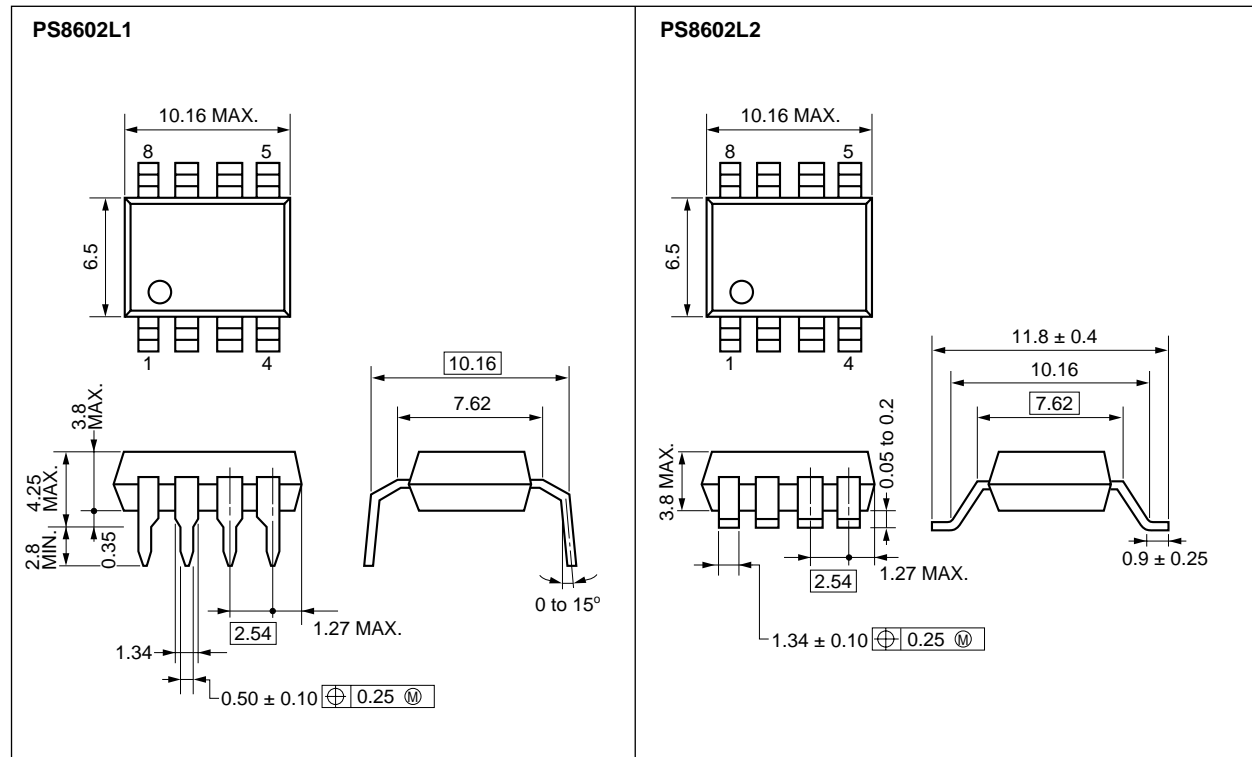

ABSOLUTE MAXIMUM RATINGS (T_A = 25 °C)

Diode

Forward Current	I _F	25	mA
Reverse Voltage	V _R	5	V
Power Dissipation	P _D	45	mW

Detector

Supply Voltage	V _{CC}	35	V
Output Voltage	V _O	35	V
Output Current	I _O	8	mA
Power Dissipation	P _C	100	mW
Isolation Voltage ^{*1}	BV	5 000	V _{r.m.s.}
Operating Temperature	T _A	-55 to +100	°C
Storage Temperature	T _{stg}	-55 to +150	°C

*1 AC voltage for 1 minute at T_A = 25 °C, RH = 60 % between input and output.

ELECTRICAL CHARACTERISTICS (T_A = 25 °C)

PARAMETER		SYMBOL	MIN.	TYP.	MAX.	UNIT	TEST CONDITIONS
Diode	Forward Voltage	V _F		1.7	2.2	V	I _F = 16 mA
	Reverse Current	I _R			10	μA	V _R = 5 V
	Forward Voltage Temperature Coefficient	$\frac{\Delta V_F}{\Delta T}$		-1.6		mV/°C	I _F = 16 mA
	Junction Capacitance	C _t		60		pF	V = 0, f = 1 MHz
Detector	High Level Output Current	I _{OH} 1		3	500	nA	I _F = 0 mA, V _{CC} = V _O = 5.5 V
	High Level Output Current	I _{OH} 2			100	μA	I _F = 0 mA, V _{CC} = V _O = 35 V
	Low Level Output Voltage	V _{OL}		0.1	0.4	V	I _F = 16 mA, V _{CC} = 4.5 V, I _O = 1.2 mA
	Low Level Supply Current	I _{CC} L		50		μA	I _F = 16 mA, V _O = Open, V _{CC} = 35 V
	High Level Supply Current	I _{CC} H		0.01	1	μA	I _F = 0 mA, V _O = Open, V _{CC} = 35 V
Coupler	Current Transfer Ratio	CTR	15			%	I _F = 16 mA, V _{CC} = 4.5 V, V _O = 0.4 V
	Isolation Resistance	R ₁₋₂	10 ¹¹			Ω	V _{in-out} = 1 kV _{DC}
	Isolation Capacitance	C ₁₋₂		0.7		pF	V = 0, f = 1 MHz
	Propagation Delay Time (H → L)	t _{PHL}		0.5	0.8	μs	I _F = 16 mA, V _{CC} = 5 V, R _L = 1.9 kΩ
	Propagation Delay Time (L → H)	t _{PLH}		0.3	0.8	μs	I _F = 16 mA, V _{CC} = 5 V, R _L = 1.9 kΩ
	Common mode transient immunity at high level output	CM _H	2 000			V/μs	I _F = 0 mA, V _{CM} = 400 V, R _L = 4.1 kΩ
	Common mode transient immunity at low level output	CM _L	-2 000			V/μs	I _F = 16 mA, V _{CM} = 400 V, R _L = 4.1 kΩ

*2 Test Circuit for Propagation Delay Time.

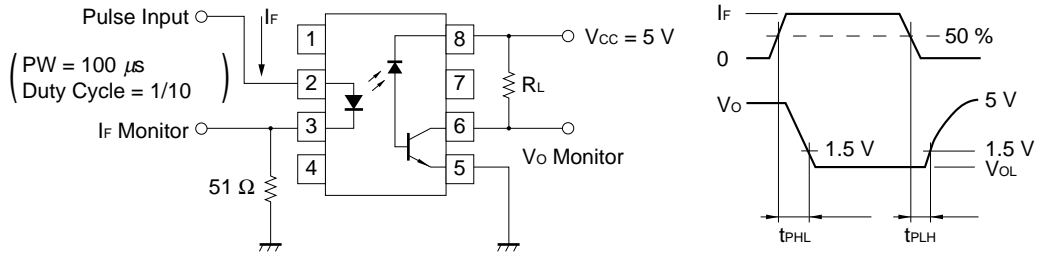

*3 Test Circuit for Common mode transient immunity

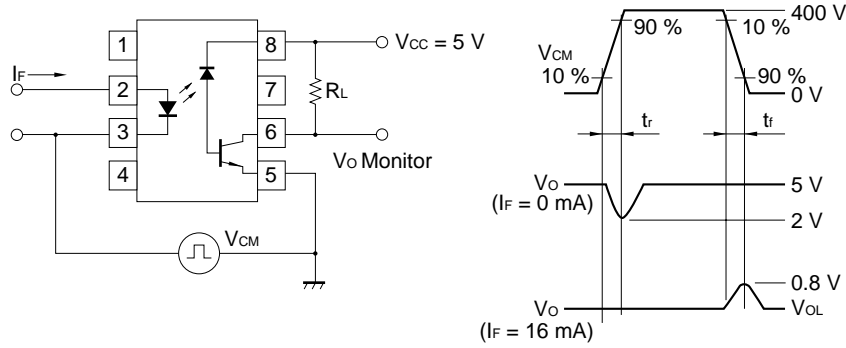

TYPICAL CHARACTERISTICS (T_A = 25 °C)

MAX. FORWARD CURRENT vs. AMBIENT TEMPERATURE

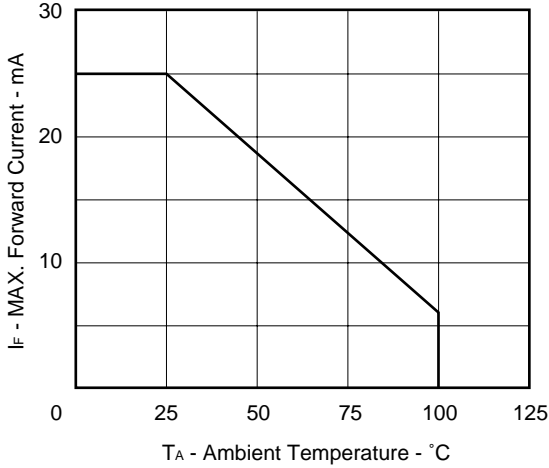

TRANSISTOR POWER DISSIPATION vs. AMBIENT TEMPERATURE

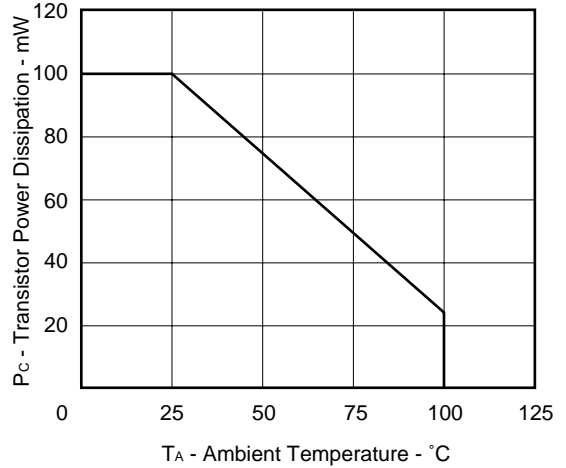

FORWARD CURRENT vs. FORWARD VOLTAGE

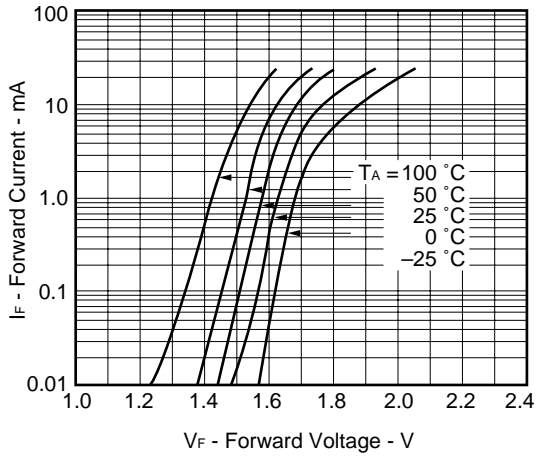

OUTPUT CURRENT vs. OUTPUT VOLTAGE

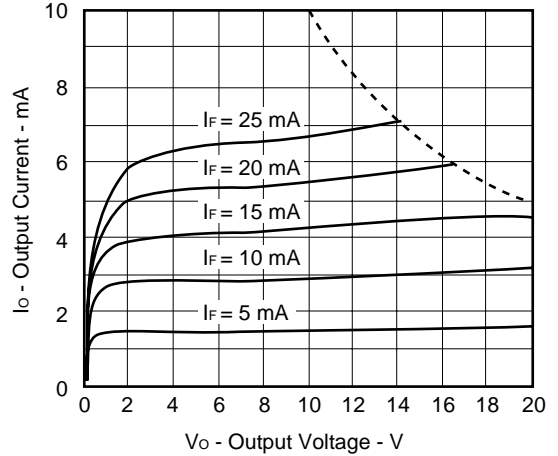

CURRENT TRANSFER RATIO vs. FORWARD CURRENT

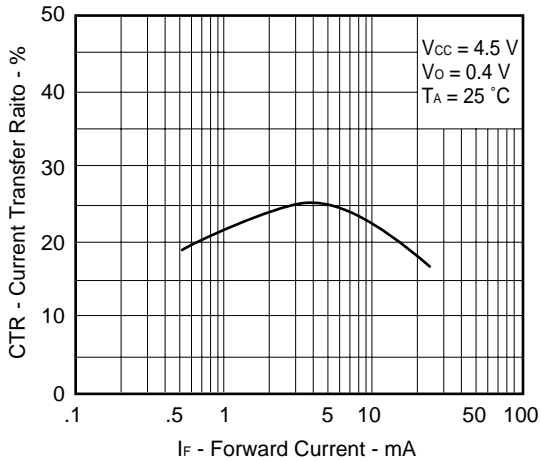

NORMALIZED OUTPUT CURRENT vs. AMBIENT TEMPERATURE

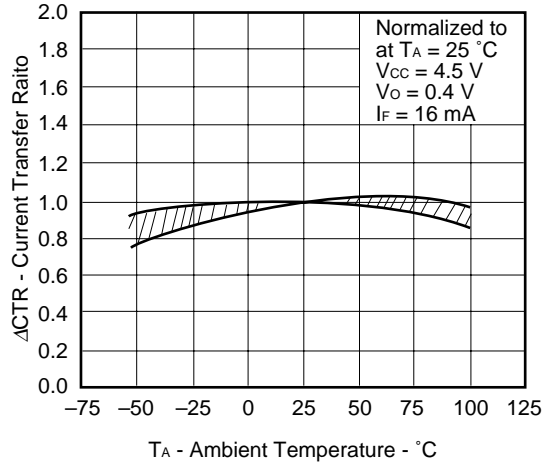

OUTPUT VOLTAGE vs. FORWARD CURRENT

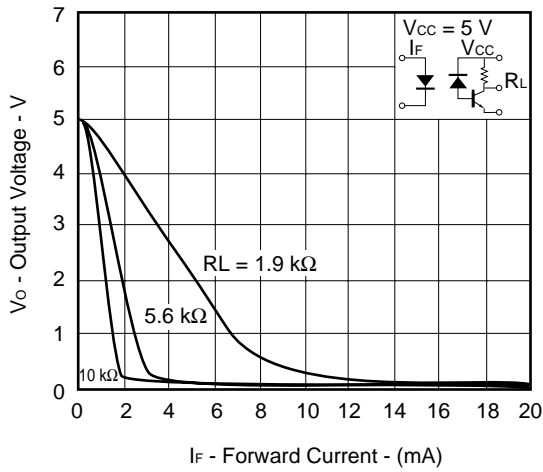

HIGH LEVEL OUTPUT CURRENT vs. AMBIENT TEMPERATURE

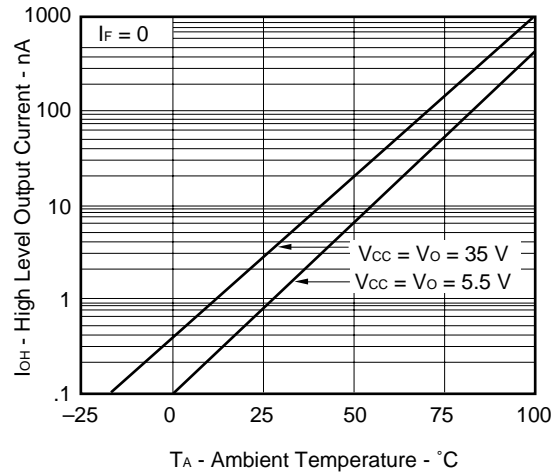

PROPAGATION DELAY TIME vs. LOAD RESISTANCE

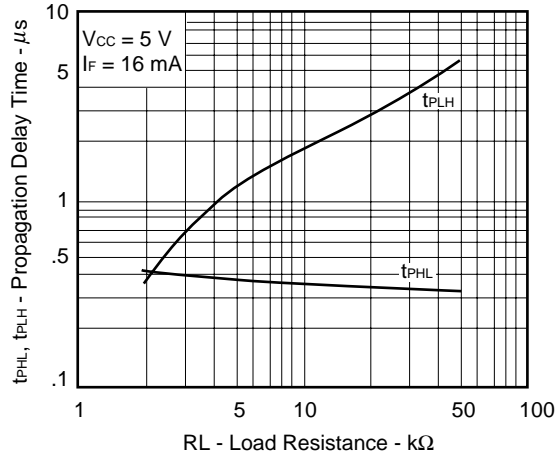

PROPAGATION DELAY TIME vs. AMBIENT TEMPERATURE

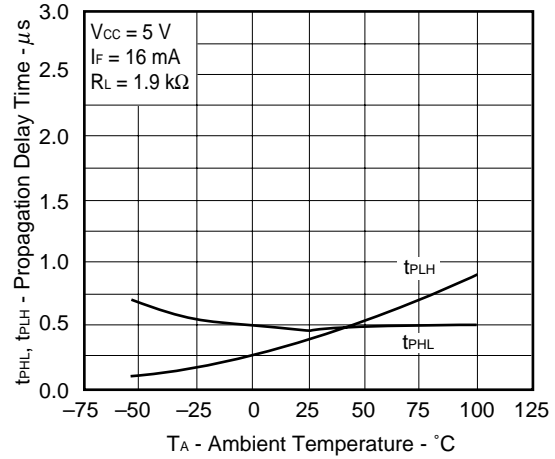

TAPING

1. TAPING DIRECTION

PS8602L-E3

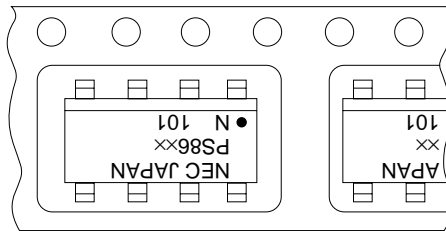

2. OUTLINE AND DIMENSIONS (TAPE)

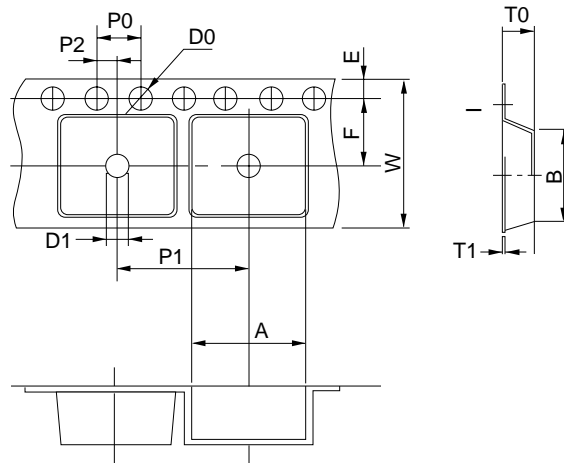

Unit: mm

SYMBOL	RATINGS
A	10.7 ± 0.1
B	10.3 ± 0.1
D0	1.55 ± 0.1
D1	1.55 ± 0.1
E	1.75 ± 0.1
F	7.5 ± 0.1
P0	4.0 ± 0.1
P1	12.0 ± 0.1
P2	2.0 ± 0.1
T0	4.3 ± 0.2
T1	0.3
W	16 ± 0.3

3. OUTLINE AND DIMENSIONS (REEL)

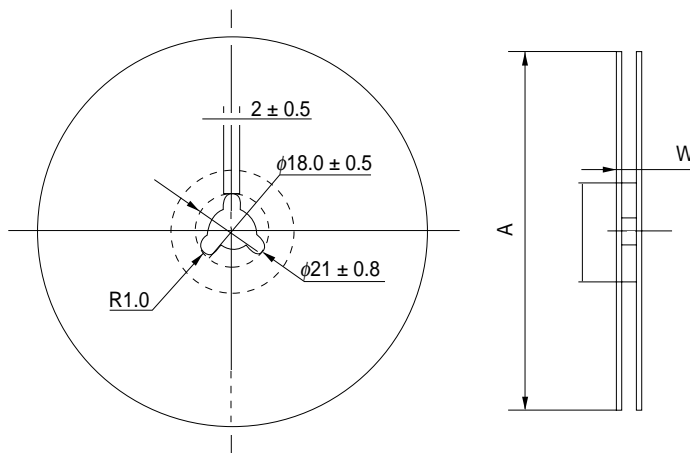

Unit: mm

SYMBOL	RATINGS
A	330
N	80 ± 5.0
W	16.4 ^{+2.0} ₋₀

4. PACKING; 1000 pieces/reel

SOLDERING PRECAUTION

(1) Infrared reflow soldering

- Peak temperature : 235 °C or lower (plastic surface)
- Time : 30 s or less
(Time during plastic surface temperature overs 210 °C)
- No. of reflow times : Three
- Flux : Rosin-base flux

INFRARED RAY REFLOW TEMPERATURE PROFILE

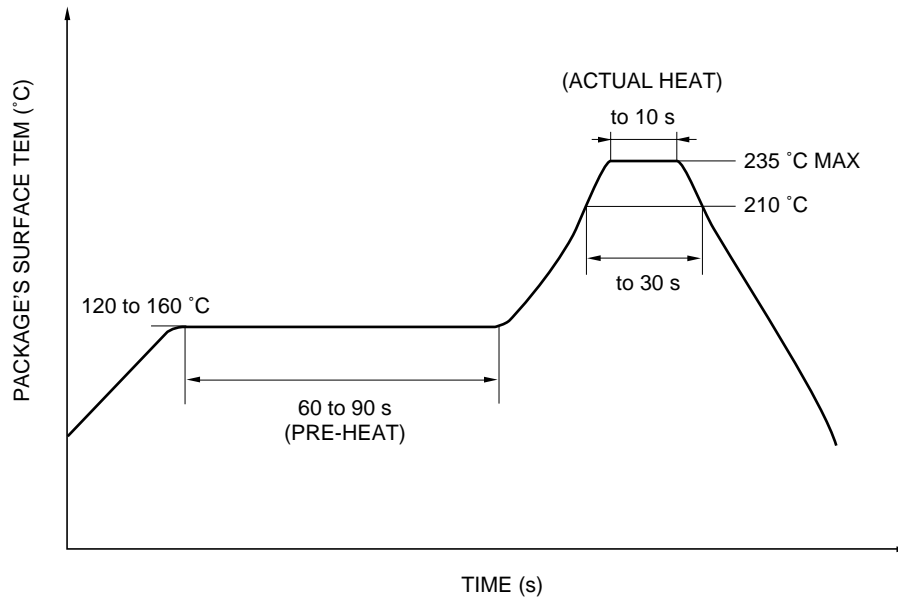

<NOTES>

- (1) Please avoid be removed the residual flux by water after the first reflow processes.

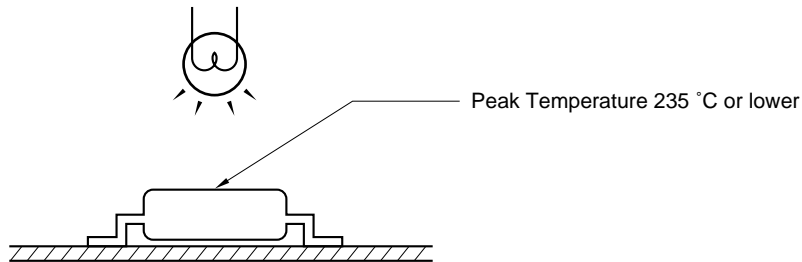

(2) Dip soldering

- Peak temperature : 260 °C or lower
- Time : 10 s or less
- Flux : Rosin-base flux

SPECIFICATION OF VDE MARKS LICENSE DOCUMENT (VDE0884)

PARAMETER	SYMBOL	SPECK	UNIT
Application classification (DIN VDE0109) for rated line voltages $\leq 300 V_{eff}$ for rated line voltages $\leq 600 V_{eff}$		IV III	
Climatic test class (DIN IEC 68 Teil 1/09.80)		55/100/21	
Dielectric strength maximum operating isolation voltage. Test voltage (partial discharge test procedure a for type test and random test) $U_{pr} = 1.2 \times U_{IORM}, Pd < 5 pC$	U_{IORM} U_{pr}	890 1 068	V_{peak} V_{peak}
Test voltage (partial discharge test procedure b for random test) $U_{pr} = 1.6 \times U_{IORM}, Pd < 5 pC$	U_{pr}	1 424	V_{peak}
Highest permissible overvoltage	U_{TR}	8 000	V_{peak}
Degree of pollution (DIN VDE0109)		2	
Clearance distance		> 7.0	mm
Creepage distance		> 7.0	mm
Comparative tracking index (DIN IEC 112/VDE0303 part 1)	CTI	175	
Material group (DIN VDE0109)		IIIa	
Storage temperature range	T_{stg}	-55 to +150	Cel
Operating temperature range	T_{amb}	-55 to +100	Cel
Isolation resistance, minimum value $U_{IO} = 500 V$ dc at 25 Cel $U_{IO} = 500 V$ dc at T_{amp} maximum at least 100 Cel	Ris min Ris min	10^{12} 10^{11}	ohm ohm
Safety maximum ratings (maximum permissible in case of fault, see thermal derating curve) Package temperature Current (input current I_F , $Psi = 0$) Power (output or total power dissipation) Isolation resistance $U_{IO} = 500 V$ dc at 175 Cel (T_{si})	T_{si} I_{si} P_{si} Ris min	175 400 700 10^9	Cel mA mW ohm

CAUTION

**The Great Care must be taken in dealing with the devices in this guide.
The reason is that the material of the devices is GaAs (Gallium Arsenide), which is
designated as harmful substance according to the law concerned.
Keep the law concerned and so on, especially in case of removal.**

No part of this document may be copied or reproduced in any form or by any means without the prior written consent of NEC Corporation. NEC Corporation assumes no responsibility for any errors which may appear in this document.

NEC Corporation does not assume any liability for infringement of patents, copyrights or other intellectual property rights of third parties by or arising from use of a device described herein or any other liability arising from use of such device. No license, either express, implied or otherwise, is granted under any patents, copyrights or other intellectual property rights of NEC Corporation or others.

While NEC Corporation has been making continuous effort to enhance the reliability of its semiconductor devices, the possibility of defects cannot be eliminated entirely. To minimize risks of damage or injury to persons or property arising from a defect in an NEC semiconductor device, customers must incorporate sufficient safety measures in its design, such as redundancy, fire-containment, and anti-failure features.

NEC devices are classified into the following three quality grades:

"Standard", "Special", and "Specific". The Specific quality grade applies only to devices developed based on a customer designated "quality assurance program" for a specific application. The recommended applications of a device depend on its quality grade, as indicated below. Customers must check the quality grade of each device before using it in a particular application.

Standard: Computers, office equipment, communications equipment, test and measurement equipment, audio and visual equipment, home electronic appliances, machine tools, personal electronic equipment and industrial robots

Special: Transportation equipment (automobiles, trains, ships, etc.), traffic control systems, anti-disaster systems, anti-crime systems, safety equipment and medical equipment (not specifically designed for life support)

Specific: Aircrafts, aerospace equipment, submersible repeaters, nuclear reactor control systems, life support systems or medical equipment for life support, etc.

The quality grade of NEC devices is "Standard" unless otherwise specified in NEC's Data Sheets or Data Books. If customers intend to use NEC devices for applications other than those specified for Standard quality grade, they should contact an NEC sales representative in advance.

Anti-radioactive design is not implemented in this product.