

## Evaluation Kit for the Single-Phase Energy Metering IC with 8052 MCU, RTC, and LCD Driver (ADE71xx/ADE75xx/ADE51xx/ADE55xx Family)

### FEATURES

- Full evaluation kit including evaluation board hardware, evaluation software, and development tools
- Supported by IAR development tools for assembly and C code development
- Isolated USB-to-UART communication
- LabVIEW evaluation software for evaluation of meter performance
- LabVIEW download tools for user firmware download
- Single evaluation board supports
  - ADE7116/ADE7166/ADE7169/ADE7566/ADE7569 and ADE5166/ADE5169/ADE5566/ADE5569
- EVAL-ADE7169EBZ-2 comes with ADE7169 IC installed
- EVAL-ADE5169EBZ-2 comes with ADE5169 IC installed

### DOCUMENTS NEEDED

- ADE7116/ADE7166/ADE7169/ADE7566/ADE7569 data sheet
- ADE5166/ADE5169/ADE5566/ADE5569 data sheet

### SOFTWARE NEEDED

- PC-based evaluation software tests the performance of the ADE7116/ADE7166/ADE7169/ADE7566/ADE7569 and ADE5166/ADE5169/ADE5566/ADE5569

### GENERAL DESCRIPTION

The EVAL-ADE7169EBZ-2/ADE5169EBZ-2 kit includes an isolated USB-to-UART converter (ADE8052Z-DWDL1) for communication and debugging purposes. The ADE7116/ADE7166/ADE7169/ADE7566/ADE7569/ADE5166/ADE5169/ADE5566/ADE5569 (hereafter referred to as ADE71xx/ADE75xx/ADE51xx/ADE55xx) family is supported by the IAR development environment. Evaluation software developed in LabVIEW™ provides the means to evaluate the performance of the ADE71xx/ADE75xx/ADE51xx/ADE55xx.

The evaluation kit includes a CD that provides all of the associated documentation, tools, and drivers to set up and use the evaluation board for the ADE71xx/ADE75xx/ADE51xx/ADE55xx.

### ADE71xx/ADE75xx/ADE51xx/ADE55xx EVALUATION BOARD

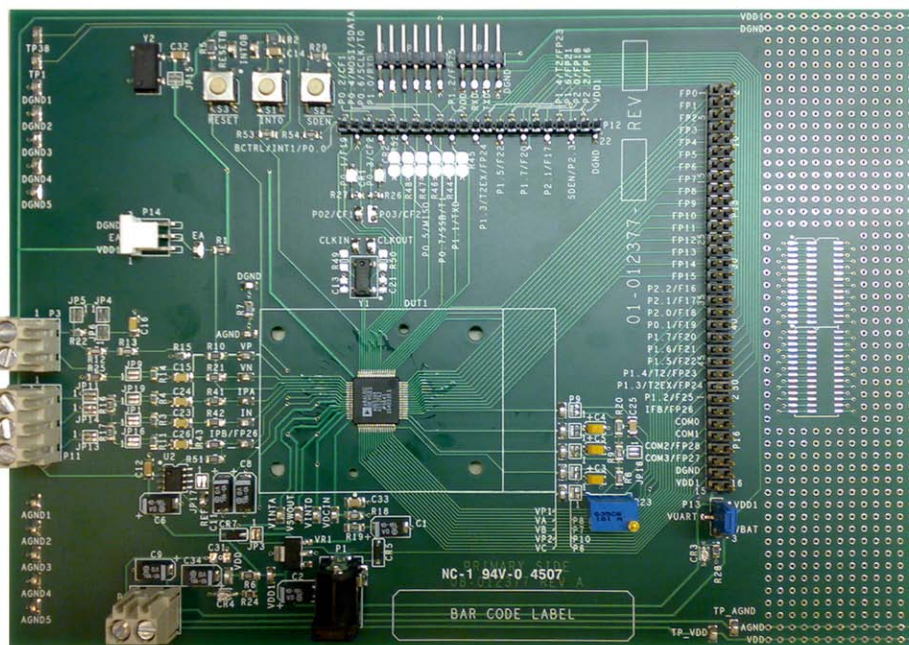

Figure 1.

## TABLE OF CONTENTS

Features .....	1	HyperTerminal Communication.....	14
Documents Needed.....	1	IAR Kickstart Tools.....	15
Software Needed.....	1	Installing the IAR Kickstart Tools.....	15
General Description.....	1	Creating a New IAR Project.....	16
ADE71xx/ADE75xx/ADE51xx/ADE55xx Evaluation Board.....	1	Project Options.....	17
Revision History .....	2	Serial Downloader.....	19
Evaluation Kit Contents.....	3	Debugging Serial Download.....	19
Quick Start.....	5	Serial Downloader Flash Protection.....	20
Connecting the Evaluation Board .....	6	Evaluation Board Software.....	21
Power Supplies and Load.....	6	Installing the Evaluation Software .....	21
Communications.....	6	Removing the Evaluation Software.....	21
Safety .....	6	Launching the Evaluation Software .....	21
Analog Inputs (P3 and P11).....	7	Troubleshooting Launch .....	22
Current Sense Inputs (P11).....	7	Main Menu.....	22
Using a CT as the Current Transducer.....	8	Evaluation Board Schematic and Artwork.....	26
Using a Shunt Resistor as the Current Transducer .....	9	PCB Layout—Component Placement.....	27
Jumper Settings.....	11	PCB Layout—Component Side.....	28
Installing the Drivers.....	12	PCB Layout—Solder Side.....	29
Installing the USB-to-UART Board (ADE8052Z-DWDL1)		Ordering Information.....	30
Driver .....	12	Bill of Materials.....	30
Finding Assigned COM Port Number.....	13	ESD Caution.....	32
Removing the Drivers.....	13		

## REVISION HISTORY

1/10—Revision 0: Initial Version

## EVALUATION KIT CONTENTS

Table 1 lists the contents of the evaluation kit that are shown in Figure 2.



ADE7169 OR ADE5169 EVALUATION KIT CD

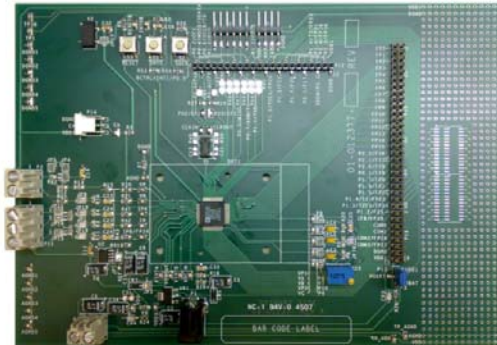

ADE71xx/ADE75xx/ADE51xx/ADE55xx EVALUATION BOARD



USB-TO-UART CONVERTER (ADE8052Z-DWDL1)



9V DC POWER ADAPTER

Figure 2. Evaluation Kit Components

086900-002

Table 1. Evaluation Kit Components

Component	Description
EVAL-ADE7169EBZ-2/ADE5169EBZ-2 Board	A printed circuit board (PCB) includes a 4-pin UART connector, 3-pin emulator connector, three push-buttons, and a prototype area.
Evaluation Kit CD	CD containing all associated software and support documentation for the evaluation kit.
9V DC Power Adapter	220 V and 110 V ac to 9 V dc power adapter. Two ac adapters are provided, a standard 2-pin European Type C plug on one side and a US adapter. A power jack connector is provided on the other side.
USB-to-UART Connector (ADE8052Z-DWDL1) <sup>1</sup>	USB cable and USB-to-UART PCB. The PCB includes a USB connector at one end and a 4-pin UART connector at the other end. This PCB provides an isolated connection.

<sup>1</sup> A replacement or additional USB-to-UART connector can be ordered from Analog Devices using Part Number ADE8052Z-DWDL1.

The evaluation kit also contains a tool package and associated software to allow the IC to be evaluated. Table 2 lists these tools and describes their operation. Many of the evaluation kit tools can also be found on the Analog Devices, Inc., website by

clicking on the **Evaluation Boards/Tools** link on any of the following product pages: [ADE7116](#), [ADE7166](#), [ADE7169](#), [ADE7566](#), [ADE7569](#), [ADE5166](#), [ADE5169](#), [ADE5566](#), or [ADE5569](#).

**Table 2. Evaluation Kit Tools**

<b>Tool</b>	<b>Program Type</b>	<b>Description</b>
Evaluation Software	LabVIEW-based software	This LabVIEW-based executable software allows the performance of the ADE71xx/ADE75xx to be evaluated. See the Evaluation Board Software section for details on the evaluation software. An additional LabVIEW program is provided to work with the ADE51xx/ADE55xx energy metering IC.
IAR KickStart <sup>1</sup>	Embedded Workbench® (KickStart version)	IAR Embedded Workbench KickStart version featuring IDE, C compiler, simulator, and debugger (C code size is limited to 4 kB). Download the latest version from the IAR website.
Serial Downloader	LabVIEW-based software	LabVIEW-based executable software is used to download hexadecimal files directly into the flash memory of the ADE71xx/ADE75xx/ADE51xx/ADE55xx. See the Serial Downloader section for details on how to use the serial downloader.
USB-to-UART Board Driver	Driver	Drivers for the USB-to-UART converter board. See the Installing the Drivers section for step-by-step instructions on how to install these drivers.

<sup>1</sup> The ADE71xx/ADE75xx/ADE51xx/ADE55xx family can also be used with Keil tools. The evaluation version of these tool can be downloaded free of charge from the Keil website.

### QUICK START

The flowchart shown in Figure 3 outlines the initial steps to set up the evaluation board and associated communication circuitry. Step-by-step instructions on how to perform each step in this flowchart are provided in the following sections of this user

guide. When the procedures in Figure 3 have been followed and the evaluation board is operational, the energy metering IC can be evaluated using the accompanying LabVIEW evaluation software.

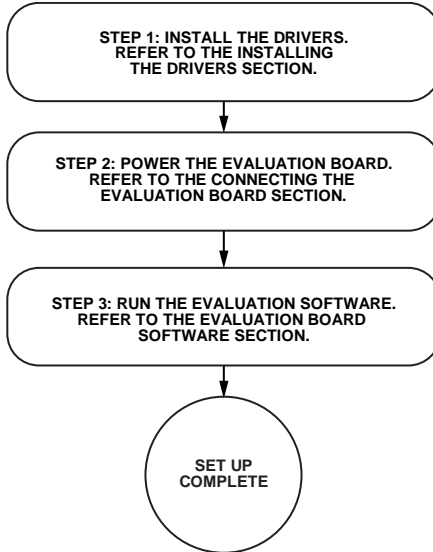

Figure 3. Quick Start Flow Diagram

## CONNECTING THE EVALUATION BOARD

Figure 4 shows a picture of the EVAL-ADE7169EBZ-2/ADE5169EBZ-2 board with the communication and power ports highlighted.

### POWER SUPPLIES AND LOAD

Power can be supplied to the EVAL-ADE7169EBZ-2/ADE5169EBZ-2 board by using the 9 V dc power adaptor that is supplied with the evaluation kit. Connect the power jack to the on-board connector shown in Figure 4. Next, insert the plug into a 220 V or 110 V mains wall socket to provide power.

Refer to the Analog Inputs (P3 and P11) section for instructions on how to connect the current and voltage signals to the chip, and note the safety instructions (see the Safety section).

### COMMUNICATIONS

Communication with the PC can be achieved using the USB-to-UART converter (ADE8052Z-DWDL1). This USB-to-UART board is isolated and, therefore, safe to connect directly to the PC even if the ground of the evaluation board is tied to 220 V, as is the case when a shunt is used as the current sensor. However, caution must be used (see the Safety section). The location of these connectors is shown in Figure 4. Connect the other end of the cable to a USB port on the PC. Prior to using the USB-to-UART board, the driver must be installed. See the

Installing the Drivers section for full details on the installation procedure.

### SAFETY

Exercise caution when connecting current or voltage sensors directly to the 220 V mains supply because the ground of the EVAL-ADE7169EBZ-2/ADE5169EBZ-2 may become live, thus creating the potential for electric shock. It is recommended to use an isolation transformer when working with the mains for safety reasons. Note that if an external dc supply is used with an isolation transformer on the mains, then the ground of the dc supply must not be connected to earth ground. If this condition occurs, then the isolation in the isolation transformer is bypassed.

The mains should not be energized before verifying the connection of the analog inputs is correct (see Figure 5 to Figure 9 in the Analog Inputs (P3 and P11) section), according to the current sensor type. In addition, JP4 on the voltage input should be verified to be open before using the mains connection to prevent damage to the IC. If connecting the board to external equipment such as a PC, ensure that the communication channel is isolated using the USB-to-UART converter. The evaluation board and communication boards should not be handled when the supply is connected.

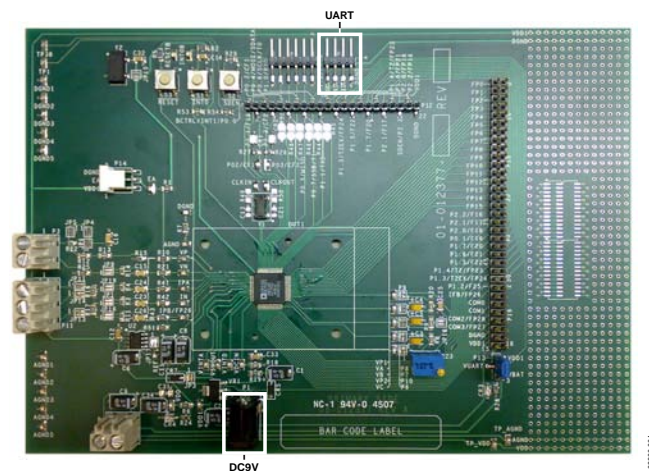

Figure 4. Evaluation Board External Connections

## ANALOG INPUTS (P3 AND P11)

Voltage and current signals are connected at the screw terminal, at P3 and P11, respectively. All analog input signals are filtered using the on-board antialias filters before being presented to the analog inputs of the energy metering IC.

### CURRENT SENSE INPUTS (P11)

P11 is a three-way connection block that allows the ADE71xx/ADE75xx/ADE51xx/ADE55xx to be connected to a current transducer.

The RC networks are the antialias filters that are required by the on-chip ADCs. The default corner frequency for these low-pass filters (LPFs) is selected as 4.8 kHz with a resistor of 1 k $\Omega$  and a capacitor of 33 nF).



**USING A CT AS THE CURRENT TRANSDUCER**

Figure 5 shows how a current transformer (CT) can be used as a current transducer in a single-phase, 2-wire distribution system. The CT secondary current is converted to a voltage by using a burden resistance across the secondary winding outputs. Care should be taken when using a CT as the current transducer. If the secondary is left open, that is, no burden is connected, a large voltage may be present at the secondary outputs. This can cause an electrical shock hazard and potentially damage electronic components.

When using a CT as the current sensor, the antialias filters should be enabled by opening Jumper JP19 and Jumper JP1 (see Figure 8).

Most CTs have an associated phase shift of between  $0.1^\circ$  and  $1^\circ$  at 50 Hz/60 Hz. This phase shift or phase error can lead to significant energy measurement errors, especially at low power factors.

However, this phase error can be corrected by writing to the phase calibration register (PHCAL[7:0]) in the ADE7169/ADE5169. The software supplied with the ADE7169/ADE5169 evaluation board allows user adjustment of the phase calibration register. See the Evaluation Board Software section for more information.

The maximum analog input range and gain for the current and voltage channels are set via the gain register (see the respective data sheet). The evaluation software allows the user to configure the channel range and gain. This means that the maximum peak differential signal on Channel 1 is 0.5 V (at gain = 1).

For an antitamper configuration, measuring both the phase and neutral currents, two CTs can be used as shown in Figure 6. Other antitamper current sensor options include one shunt and one CT, as shown in Figure 7.

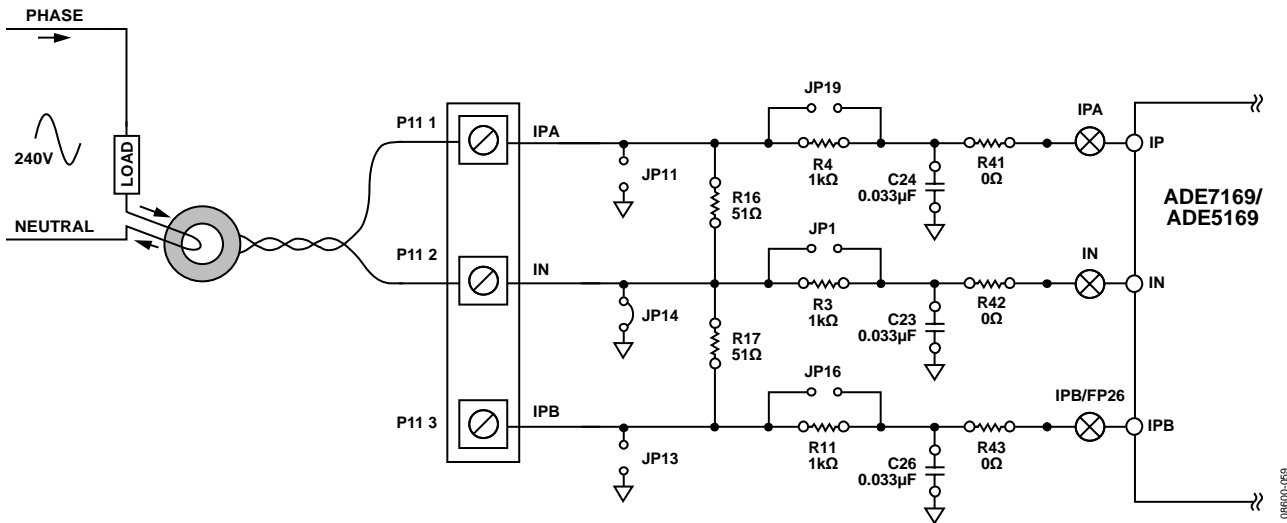

Figure 5. CT Sensor Connection to Current Channel

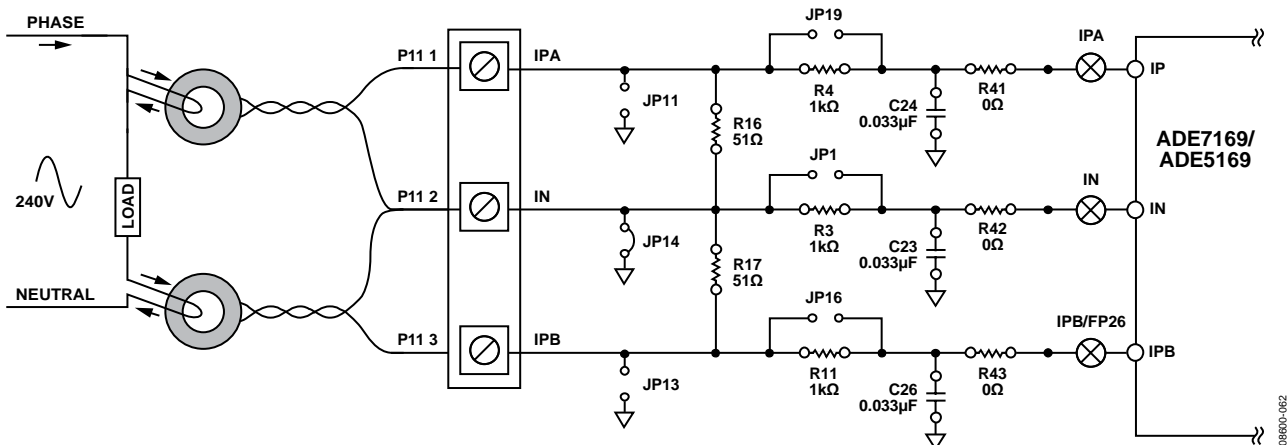

Figure 6. Connecting Two CTs to the Current Channels



### USING A SHUNT RESISTOR AS THE CURRENT TRANSDUCER

Figure 8 shows how a shunt resistor can be used to perform the current-to-voltage conversion required for the ADE71xx/ADE75xx/ADE51xx/ADE55xx. A shunt is a very cost effective way to sense current in a 2-wire, single-phase application. Isolation is not typically required in a 2-wire application and the shunt has advantages over the CT arrangement. For example, a shunt does not suffer from dc saturation problems and the phase response of the shunt is linear over a very wide dynamic range. Although the shunt is predominately resistive, it does have parasitic reactive elements (inductance) that can become significant, even at 50 Hz/60 Hz. This means that there can be a small phase shift associated with the shunt. However, the phase shift is easily compensated by writing to the phase calibration register (PHCAL[7:0]) in the ADE71xx/ADE75xx/ADE51xx/ADE55xx.

Figure 8 shows how the shunt can be connected to the evaluation board. Two sense wires should be soldered to the shunt at the copper/manganese junctions as shown. These sense wires should be formed into a twisted pair to reduce the loop area, which in turn reduces antenna effects. A connection for the common-mode voltage can be made at the connection point for the current-carrying conductor.

For an antitamper configuration, measuring both the phase and neutral currents, two CTs can be used, as shown in Figure 6. Other antitamper current sensor options include one shunt and one CT, shown in Figure 7.

It is not possible to use two shunt resistors as current sensors for use in an antitamper configuration with the ADE71xx/ADE51xx products because, with a shunt resistor, the line or the neutral is used as a ground reference for the ADE71xx/ADE51xx IC. There is no isolation between the two current channels in the ADE71xx/ADE51xx, and the line and neutral would be effectively shorted together, which is dangerous.

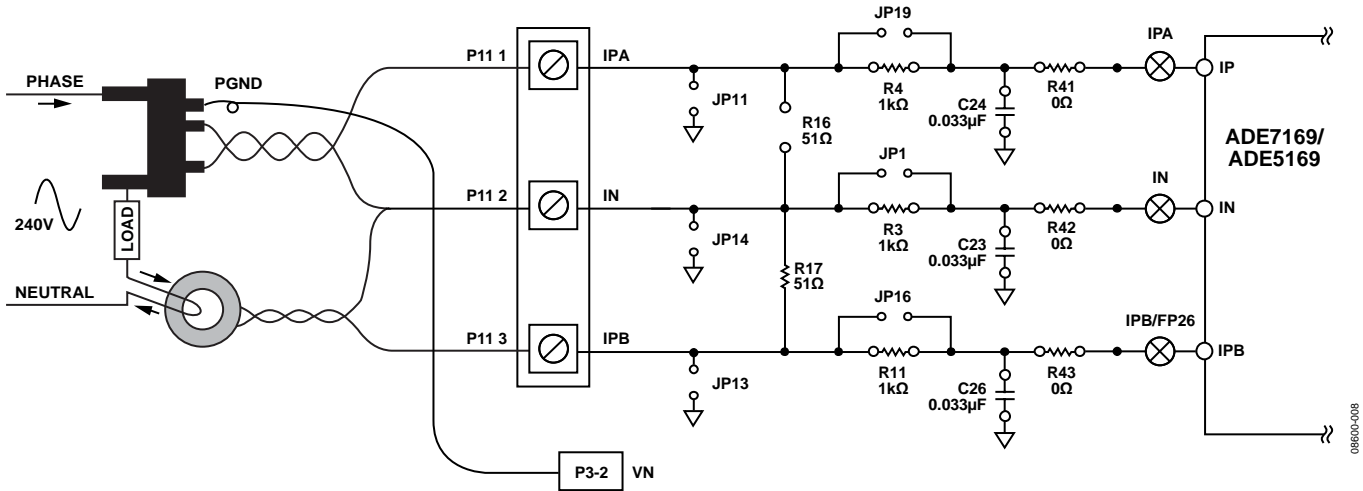

Figure 7. Connecting One Shunt and One CT to the Current Channels

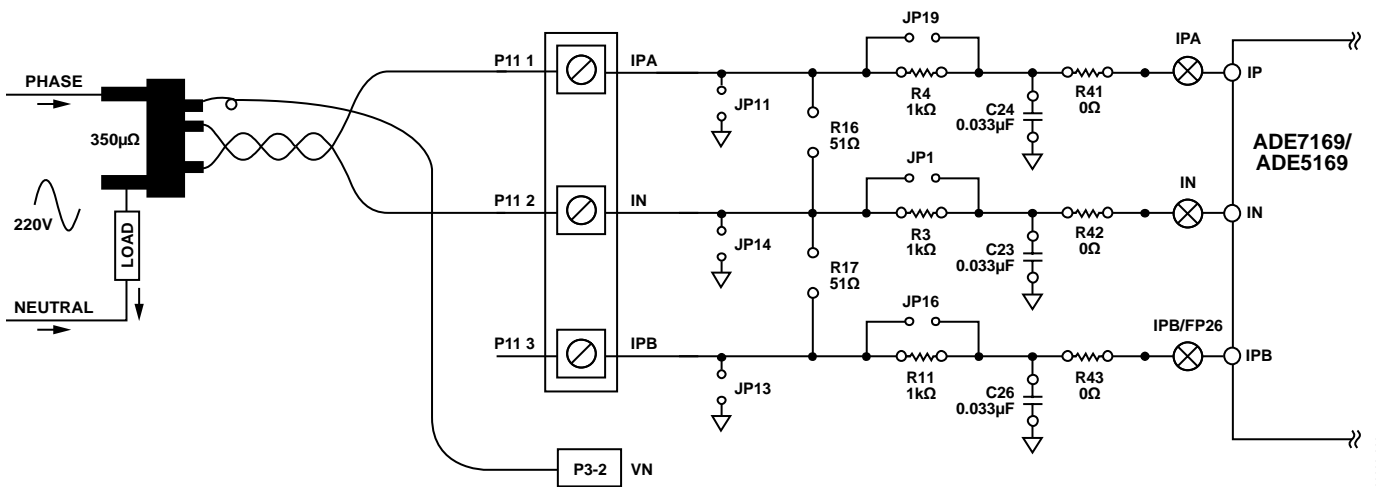

Figure 8. Shunt Resistor Used as Current Transducer

**Voltage Sense Inputs**

The voltage input connections on the ADE71xx/ADE75xx/ADE51xx/ADE55xx evaluation board can be connected directly to the line voltage source. However, an isolation transformer is recommended for safety reasons. The line voltage is attenuated using a simple resistor divider network before it is presented to the ADE71xx/ADE75xx/ADE51xx/ADE55xx. The voltage channel is recommended to be used in a single-ended configuration. Figure 9 shows a typical connection for the line voltage.

Note that the analog input VN is connected to AGND via the antialias filter R14/C15. Jumper JP9 should be left open.

The voltage attenuation network is made up of R12, R13, and R15. The maximum signal level permissible at VP is 0.5 V peak. The signal range should not exceed  $\pm 0.5$  V with respect to AGND for specified operation.

The attenuation network can be easily modified by the user to accommodate any input signal level. However, the value of R15 (1 k $\Omega$ ) should not be altered because the phase response of Channel 2 should match that of Channel 1.

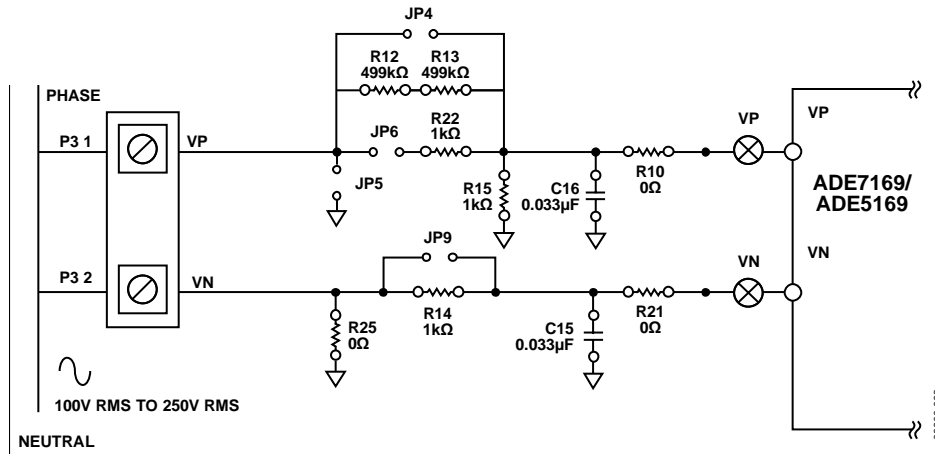

Figure 9. Typical Line Voltage Connection

## JUMPER SETTINGS

Table 3. Jumper Settings

Function	Jumper Option	Description
P2 UART Power Supply Selection	Pin 1 and Pin 2 of P13 closed	P2 UART power supplied by VDD on the board
	Pin 2 and Pin 3 of P13 closed	P2 UART power supplied by VBAT
LCD Voltage Source Selection	Pin 1 and Pin 2 of P6, P7, P8, and P9 closed	LCD voltage source using the resistor divider from VDD
	Pin 2 and Pin 3 of P6, P7, P8, P9, and P10 closed	LCD voltage source using internal charge pump
Voltage Channel Input	JP4, JP5, JP6 and JP9 open	Using the on-board resistor divider network for voltage attenuation
Current Channel Input	JP1, JP11, JP13, JP14, JP16, and JP19 open; R16 and R17 removed	Using shunt but no second current channel
	JP1, JP11, JP13, JP14, JP16, and JP19 open; R16 removed; R17 installed	One shunt and one CT for two current channel inputs <sup>1</sup>
	JP1, JP11, JP13, JP16, and JP19 open; R16 and R17 installed; JP14 closed	Two CTs for two current channel inputs <sup>1</sup>
Reference Voltage Source Selection	JP17 open	Using the internal $V_{REF}$ voltage reference for ADC

<sup>1</sup> The second channel current input is only supported by the ADE7169, ADE7166, ADE5166, and ADE5169.

## INSTALLING THE DRIVERS

The USB-to-UART board connects to the PC via the USB port. For correct operation, install associated Windows®-based software drivers prior to use.

The drivers can be found on the accompanying CD-ROM as well as on the Analog Devices energy metering website. Visit the associated product page and click **Evaluation Boards/Tools**.

### INSTALLING THE USB-TO-UART BOARD (ADE8052Z-DWDL1) DRIVER

1. Connect the USB cable to the PC and to the USB-to-UART board. The following window appears indicating that the PC has detected the new hardware:



Figure 10. USB2UART Found

2. Click the **Install from a list or specific location (Advanced)** option and then click **Next >**.
3. Select **Include this location in the search** and use the **Browse** button to locate the **Drivers\USB2UART** folder on the evaluation kit CD.

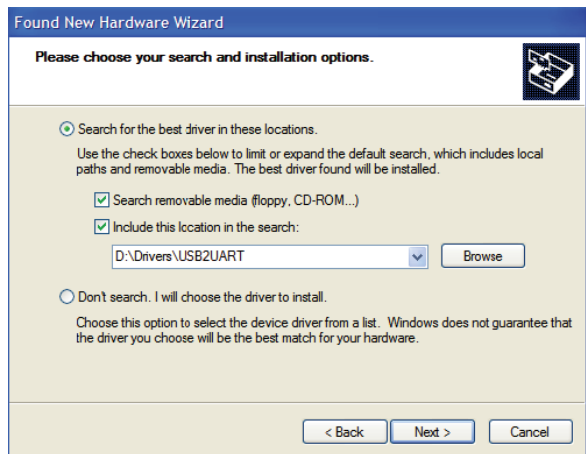

Figure 11. Search for USB2UART Driver

4. Click **Next >**.

5. The prompt shown in Figure 12 appears, stating that the hardware did not pass the Windows Logo test.

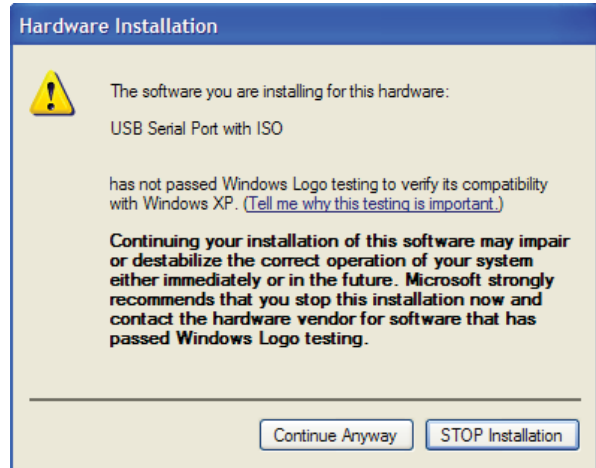

Figure 12. Install USB2UART Hardware

6. Click **Continue Anyway**.
7. When the installation is complete, the window shown in Figure 13 appears.

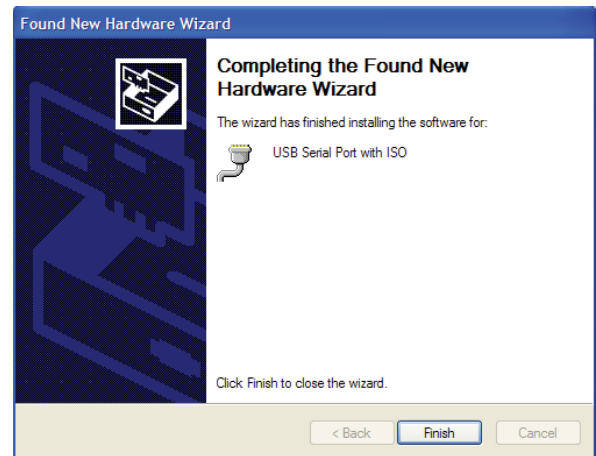

Figure 13. USB-to-UART Installation Complete

8. Click **Finish** to complete this process. Windows then issues a second set of prompts to install the USB drivers to a COM port.
9. Repeat Step 2 through Step 8 to complete the USB-to-UART driver installation.

### FINDING ASSIGNED COM PORT NUMBER

Install the drivers for the USB-to-UART converter on each USB port used with the board. After installation, the PC detects the drivers as a regular communication port. Note that there is no serial number assigned to either the USB-to-UART board or the emulator pod and, therefore, several boards can be used on the same USB port without the need to install the driver. To determine which COM port number has been assigned to the connected board, open the **Device Manager** under Windows using the following steps:

1. Click the **Start** button located at the bottom left-hand corner of the desktop.
2. Select **Control Panel**, then **System** to open the **System Properties** window.
3. Select the **Hardware** tab and click **Device Manager** (see Figure 14).

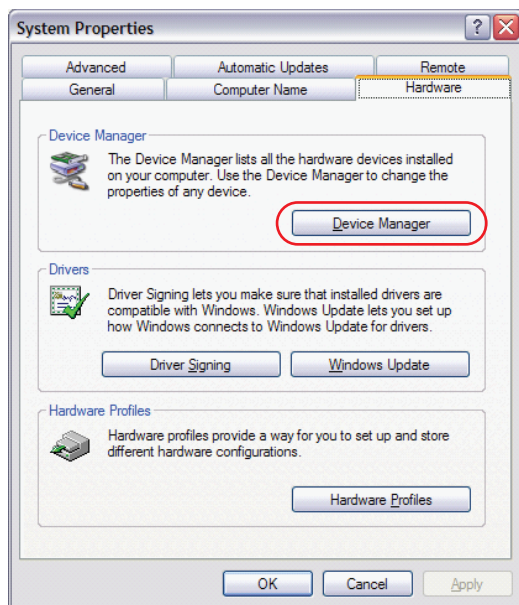

Figure 14. System Properties Window

If the driver is installed properly, the attached device appears under **Ports (COM & LPT)**, as shown in Figure 15.

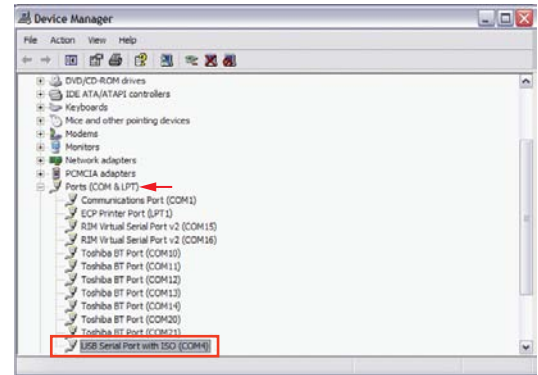

Figure 15. Device Manager Window

### REMOVING THE DRIVERS

The USB-to-UART drivers can be easily removed using the **Add or Remove Programs** feature in the **Control Panel**. Click the **Start** button located at the bottom left-hand corner of the desktop, select **Control Panel**, then **Add or Remove Programs**, and click the drivers to remove them.

## HYPERTERMINAL COMMUNICATION

The PC HyperTerminal can be used to verify communication with the UART serial interface and read back the ID string of the ADE71xx/ADE75xx/ADE51xx/ADE55xx on the evaluation board. The HyperTerminal is also a useful troubleshooting tool for verifying successful communication between the EVAL-ADE7169EBZ-2/ADE5169EBZ-2 and the PC.

Connect the USB-to-UART board to both P2 of the EVAL-ADE7169EBZ-2/ADE5169EBZ-2 and the USB connection on the PC. Prior to using the USB-to-UART board, install the associated drivers (see the Installing the USB-to-UART Board (ADE8052Z-DWDL1) Driver section for details). Apply power to the evaluation board by using the 9 V dc supply. To establish communication with the PC HyperTerminal, follow these steps:

1. Click the **Start** button located at the bottom left-hand corner of the desktop, then select **Programs**, then **Accessories**, then **Communications**, and finally **HyperTerminal** to launch the HyperTerminal window.
2. In the **Name** box, enter a name for the new connection.
3. Click **OK**.
4. In the **Connect Using** drop-down box, select the COM port that the USB cable is connected to and click **OK**.
5. On the properties window, select **9600** as the baud rate from the **Bits per second** drop-down box. The data bits should be set to **8**, the parity set to **None** and the stop bits set to **one**. The flow control should be set to **None**.
6. Click **Apply**.
7. Click **OK** and the HyperTerminal window appears.
8. Place the part in serial download mode to verify communication by pressing and holding the SDEN push-button, S2, while issuing a reset. This is accomplished by

pressing and releasing the **RESET** push-button, S3. Then releasing the SDEN push-button, S2.

9. The ADE71xx/ADE75xx/ADE51xx/ADE55xx identification string should appear on the HyperTerminal window, as shown in Figure 16.

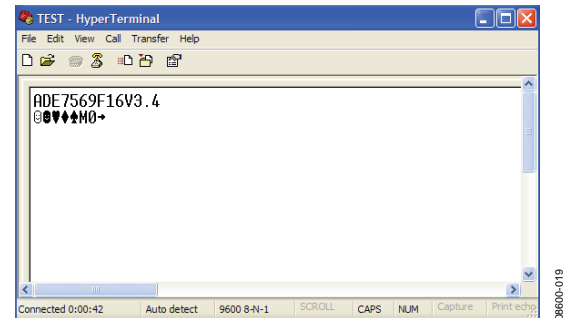

Figure 16. HyperTerminal

The telephone icon (see Figure 22) on the top of the HyperTerminal window can be used to disconnect the HyperTerminal connection.



Figure 17. Telephone Icon

Following these steps confirms that the ADE71xx/ADE75xx/ADE51xx/ADE55xx is powered up correctly and that communication has been established between the EVAL-ADE7169EBZ-2/ADE5169EBZ-2 and the PC via the USB-to-UART serial interface.

# IAR KICKSTART TOOLS

## INSTALLING THE IAR KICKSTART TOOLS

The IAR Embedded Workbench KickStart version that is provided in the evaluation kit offers an unlimited assembly language development environment and a 4 kB compiled output limited C environment. This environment allows the user to write, compile, and debug code. Code can be downloaded to the ADE71xx/ADE75xx/ADE51xx/ADE55xx and then debugged in circuit. The USB-to-UART allows the user to set breakpoints to debug their code. Another board, the ADE8052Z-EMUL1, can be purchased separately which allows the user to emulate code by stepping through code line by line.

To install the IAR KickStart tools, follow these steps:

1. Open the **EW8051-7.30B-KS-ADL.zip** file that is located in the IAR folder of the evaluation kit CD.
2. Run the **Start.exe** application file located in this folder. This extracts the KickStart tools.

The window shown in Figure 18 appears.



Figure 18. IAR KickStart

3. Click the **Software Installations** option.
4. Click the **KickStart Edition** option shown in Figure 19.



Figure 19. IAR Software Installation

5. A series of windows appears with installation options. Select the **Install the IAR Embedded Workbench KickStart Edition** option in each window.
6. Click **Next** and then **Accept** on the agreement window.
7. Then enter the license number and license key. These can be found on the CD cover of the evaluation kit. Carefully enter these on the respective windows and click **Next**.
8. Prior to installing, select the location that the KickStart tools are to be placed. If a location other than the default destination folder is required, use the **Browse** button to navigate to the desired location.
9. Click **Next** on the subsequent windows to confirm the settings and begin the installation. Note that the installation takes a few minutes to complete.

When the installation has been completed properly, the window shown in Figure 20 appears.



Figure 20. IAR Setup Complete

10. Click **Finish** to exit the setup.
11. To open the IAR Embedded Workbench, click the **Start** button located at the bottom left-hand corner of the desktop, select **Programs**, then **IAR Systems**, and then **IAR Embedded Workbench**.



**CREATING A NEW IAR PROJECT**

1. Create a new folder in the location where the new IAR project is to be placed.
2. Launch the IAR Embedded Workbench by clicking the **Start** button, then select **Programs**, then **IAR Systems**, and then **IAR Embedded Workbench**. The **Embedded Workbench Startup** window shown in Figure 21 appears.

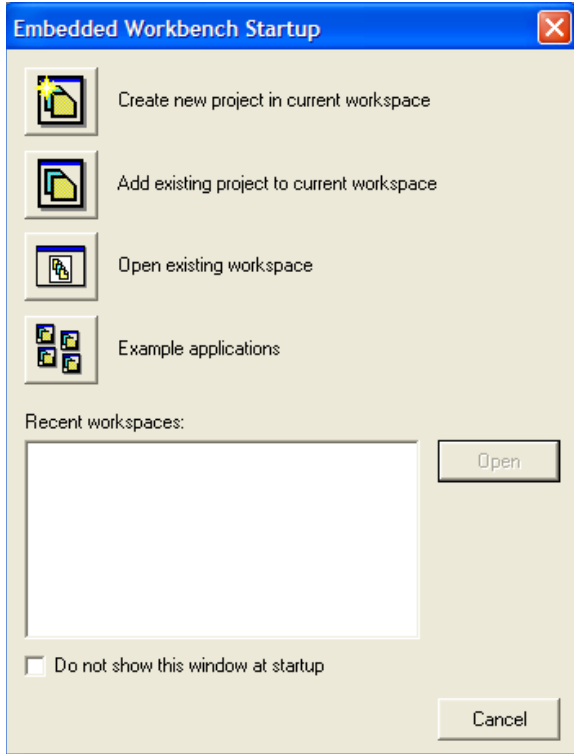

Figure 21. Embedded Workbench Startup

3. Click the **Create new project in current workspace** option.  
The **Create New Project** window (shown in Figure 22) appears.

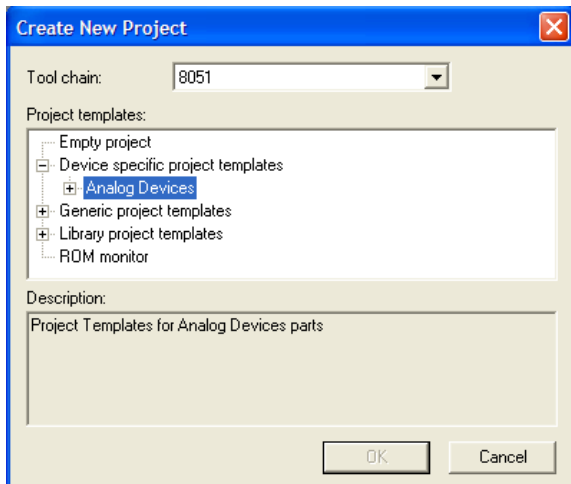

Figure 22. Create New Project Options

4. Expand the **Device specific project templates** folder by clicking the + symbol next to the folder.
5. Expand the **Analog Devices** folder by clicking the + symbol next to the folder.

A list of Analog Devices products appears (see Figure 23).

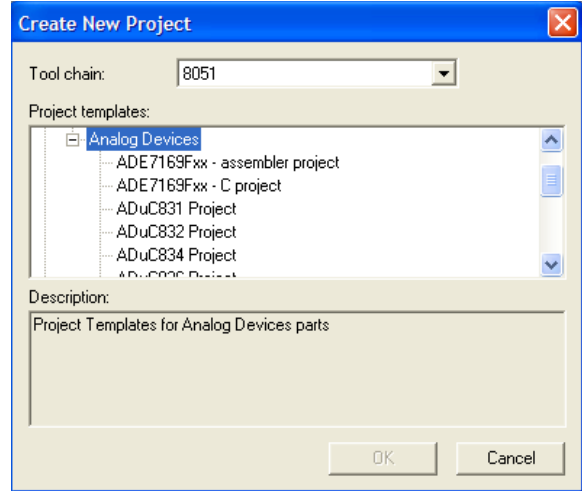

Figure 23. ADE7169 Project

6. If an assembly language project is required for the ADE71xx and ADE75xx parts, select the **ADE7169Fxx – assembler project**. If a C language project is desired, select **ADE7169Fxx – C project** and click the **OK** button. For the ADE51xx and ADE55xx parts, select **ADE5169Fxx – assembler project** and **ADE5169Fxx – C project**, respectively.
7. When prompted, give the project a name and save it in the desired folder.

IAR copies the template files into the specified folder and creates a main.c or main.asm file depending on the language selection. Figure 24 shows the template for a new C language project.

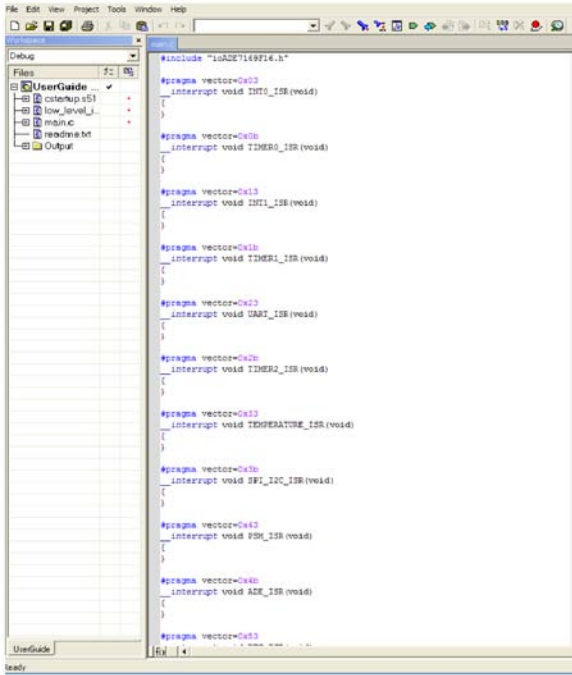

Figure 24. Project Template

The project template files include the interrupt vector table and a header file that defines the registers. Two header files exist: one for the ADE71xx and ADE75xx family and another for the ADE51xx and ADE55xx family. Develop new code using this template.

**PROJECT OPTIONS**

When a new project is created using the ADE7169Fxx or ADE5169Fxx assembly or C template, a set of default project options are set. These options set up the compiler, assembly, communication, and debugger. The project options are accessible by right-clicking on the project name at the top of the **Files** column on the IAR Embedded Workbench IDE (see Figure 24 under the **Workspace** section). Figure 25 shows the **Options for node "UserGuideasm"** project options window.

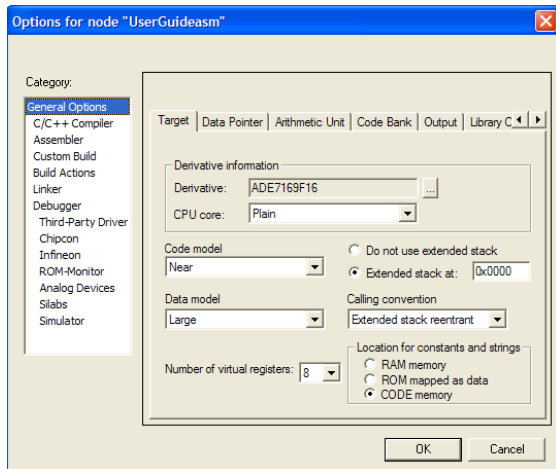

Figure 25. Project Options

**Target Selection**

The default project settings of the ADE7169Fxx and ADE5169Fxx C and assembly templates configure the project to execute in an ADE7169Fxx or ADE5169Fxx target. If this is not desired, the simulator can be selected by clicking the **Debugger** category. In the **Setup** tab under the **Driver** option, select **Simulator**.

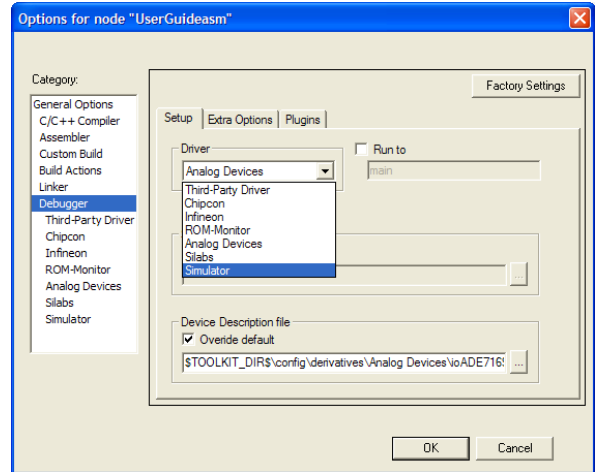

Figure 26. Debugger Options

**Communication**

Communication between the EVAL-ADE7169EBZ-2/ADE5169EBZ-2 evaluation board and the PC can be achieved using either the USB-to-UART connections, or the emulation pod. Prior to using either of these tools, the corresponding drivers must be installed. See the Installing the Drivers section for more details. The corresponding COM port must then be selected.

1. In the **Analog Devices** category in the project options window, select the **Serial Port** tab.
2. Using the **Port** drop-down box, select the COM port that the USB-to-UART has been assigned to (see Figure 27). See the Finding Assigned COM Port Number section to determine the COM port that is in use.

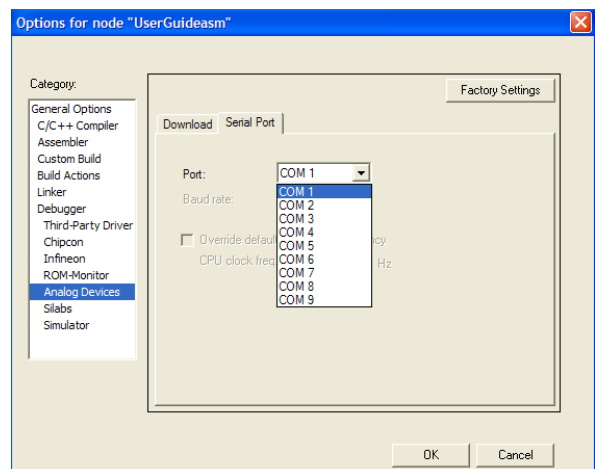

Figure 27. COM Port Selection

The project options required for each of the communication methods are described in the following sections. These options are also outlined in the **readme.txt** file included in the project files. Note that the ADE7169Fxx and ADE5169Fxx template projects default to using the USB-to-UART board settings for downloading code to the target.

**Project Options When Using the USB-to-UART Board**

1. In the **Analog Devices** category in the project options window, select the **Download** tab.
2. Select the **UART debug mode** check box.
3. Select the **Ade device protocol** check box.
4. The ADE71xx/ADE75xx/ADE51xx/ADE55xx incorporates an internal downloaded verification; therefore, ensure that the **verify download** button is cleared because the IAR protocol is not supported.

**Project Options When Using the Emulation Pod**

In the **Analog Devices** category in the project options window, select the **Download** tab. Clear the **UART debug mode** check box and select the **Ade device protocol** box. The ADE71xx/ADE75xx/ADE51xx/ADE55xx incorporates an internal downloaded verification; therefore, ensure that the **verify download** box is cleared because the IAR protocol is not supported.

**Creating a Hexadecimal File**

The user can configure the project options so that IAR generates a hexadecimal file each time the project is built. This hexadecimal file can then be downloaded to the part using the serial downloader (see the Serial Downloader section). Select the **Linker** category in the project options as shown in Figure 28.

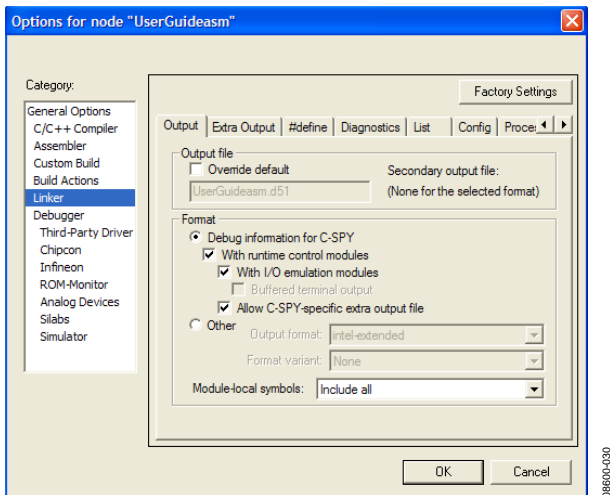

Figure 28. Hexadecimal File Generation

1. Under the **Output** tab, select the **Allow C-SPY-specific extra output file** box.
2. Under the **Extra Output** tab, in the **Output file** box, type the name of the hexadecimal file that is going to be generated complete with a .hex file type (see Figure 29).

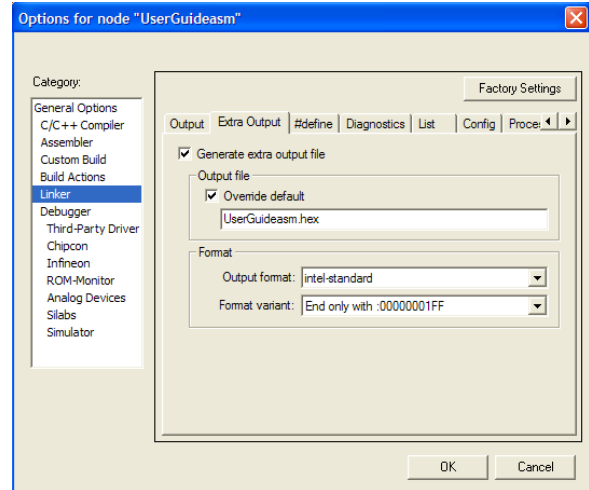

Figure 29. Hexadecimal File Define

After the project has been built, the hexadecimal file can be found in the project folder in the **Debug > Exe** subfolder.

**Downloading User Firmware**

Place the part in serial download mode by pressing and holding the **SDEN push-button**, S2, while issuing a **reset** by pressing and releasing the **RESET push-button**, S3. The **SDEN push-button** should then be released. When in serial download mode, click the debug icon shown in Figure 30 located on the toolbar of the IAR workbench.



Figure 30. IAR Debug Icon

When the download is complete, click the **Run** icon to start the code. Alternatively, the **RESET push-button**, S3, can be pressed to start the code.

## SERIAL DOWNLOADER

The ADE71xx/ADE75xx and ADE51xx/ADE55xx standalone serial downloaders can be used to download Intel® hexadecimal files to the 16 kB of on-chip flash memory. Data transfer takes places through the UART serial interface. The serial downloaders can also be used to configure read and write protection on the ADE71xx/ADE75xx and ADE51xx/ADE55xx families of parts. Note that there are two downloader programs, one targeted at the ADE71xx/ADE75xx and another for the ADE51xx/ADE55xx. There are two different software programs because the two families have different flash protection schemes. The commands used to initiate the serial download are an extension of the commands listed in the uC004 Technical Note, *Understanding the Serial Download Protocol*, available at [www.analog.com](http://www.analog.com).

Prior to using the serial downloader, the evaluation board should be powered by the 9 V dc supply. Connect the USB-to-UART board to the P2 header and the USB connection on the PC. If using the USB-to-UART board for the first time, install the USB-to-UART drivers. See the Installing the Drivers section for details.

Figure 32 shows the interface for the ADE71xx/ADE75xx serial downloader. A similar program allows downloading to the ADE51xx/ADE55xx. To download code to the flash memory, locate the required hexadecimal file using the **Browse** button and then place the part in serial download mode. This is achieved by pressing and holding the **SDEN** push-button, S2, while issuing a **reset** by pressing and releasing the **RESET** push-button, S3. The **SDEN** push-button, S2, should then be released. Once in serial download mode, click the **Find Device and Reset** button on the serial downloader interface. The message shown in Figure 32 then displays on the serial downloader interface.

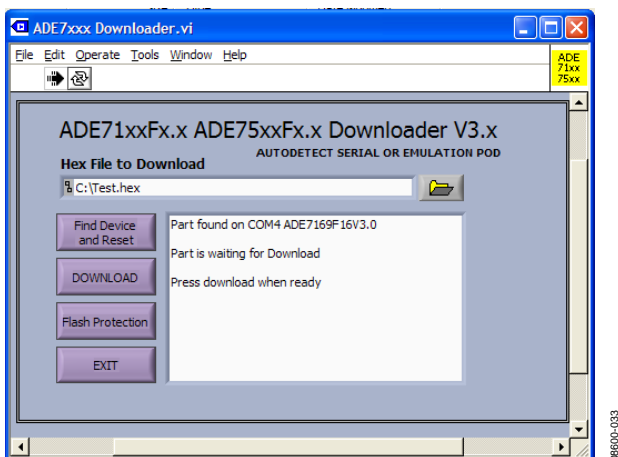

Figure 31. Serial Downloader—Reset

When communication is established, click the **Download** button to initiate the download. When the download is complete, the message shown in Figure 32 appears.

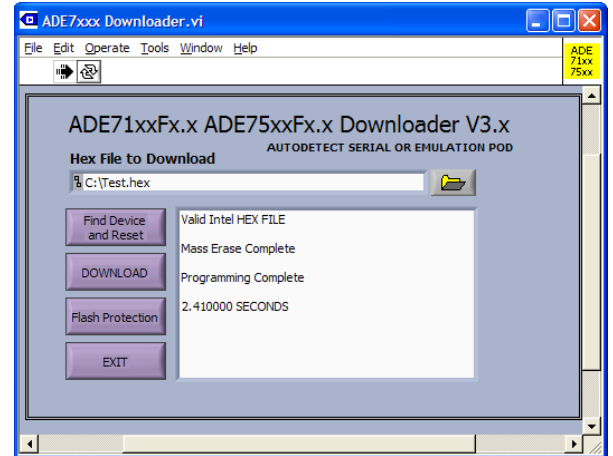

Figure 32. Serial Downloader—Complete

Note that the download time varies depending on the size of the hexadecimal file that is being downloaded.

After the code has been downloaded properly, press the **RESET** push-button, S3, to begin the code execution.

### DEBUGGING SERIAL DOWNLOAD

If the part cannot be found by the serial downloader, the message shown in Figure 33 appears.

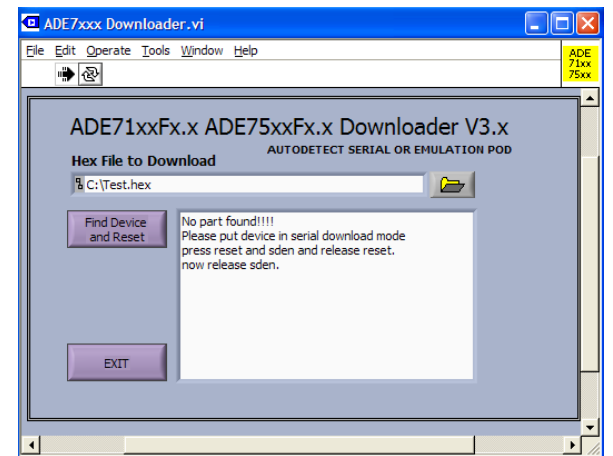

Figure 33. Serial Downloader—Part Not Found

The part cannot be found if the ADE71xx/ADE75xx is not correctly powered or if the serial downloader cannot communicate with the EVAL-ADE7169EBZ-2/ADE5169EBZ-2. Another possible cause of this failure is that the ADE71xx/ADE75xx is not in serial download mode. Ensure that the ADE71xx/ADE75xx is receiving 3.3 V from the 9 V dc power supply. This can be verified using an oscilloscope or voltmeter to probe both the VDD and VINTD test pins. Ensure that the USB-to-UART board is connected to the P2 header and that the necessary drivers have been installed (see the Installing the Drivers section). Use the procedure outlined in the HyperTerminal Communication section to verify that communication has been established.

Place the part in serial download mode once again by pressing the push-button sequence described in the Serial Downloader section.

**SERIAL DOWNLOADER FLASH PROTECTION**

Configure the flash protection by using the ADE71xx/ADE75xx serial downloader interface. Clicking the **Flash Protection** button on the serial downloader panel brings up the window shown in Figure 34. Configure the protection after downloading the required hexadecimal file to the flash memory but prior to pressing the **RESET** button, S3, to begin code execution.

From this window, the write/erase and read protection can be set up for each of the 31 pages of flash. Changes made to the

flash protection should be written to the part using the **WRITE** command. Note that when the **WRITE** button is clicked, the flash memory is directly modified and, therefore, once a page has been locked (that is, 0x00 written to the flash location) it cannot be unlocked (that is, restored to 0xFF) without resetting the part. To activate the protection, reset the ADE71xx/ADE75xx by pressing the **RESET** push-button, S3. Note that for best practice, do not enable the read or write/erase protection while debugging or emulating code. A full description of the flash protection scheme can be found in the respective data sheet.

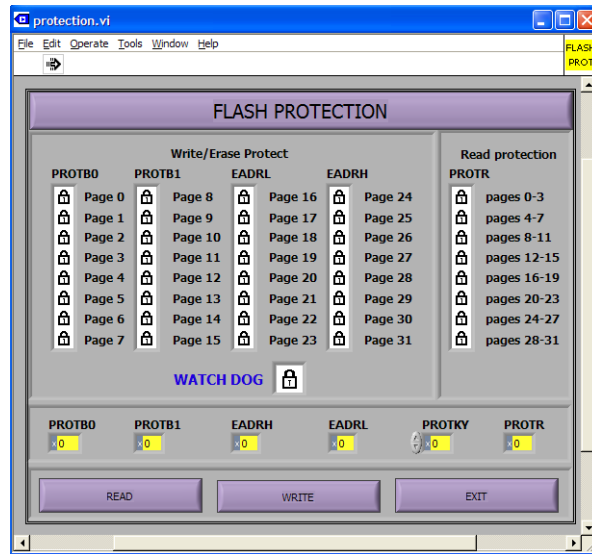

Figure 34. Serial Downloader Flash Protection

## EVALUATION BOARD SOFTWARE

The ADE71xx/ADE75xx/ADE51xx/ADE55xx evaluation kit contains PC-based evaluation software for testing the performance of the ADE71xx/ADE75xx/ADE51xx/ADE55xx. This software was developed using LabVIEW software from National Instruments and it is included on the ADE71xx/ADE75xx/ADE51xx/ADE55xx evaluation kit CD. It can also be found on the Analog Devices website, via the product page for the [ADE7116](#), [ADE7166](#), [ADE7169](#), [ADE7566](#), [ADE7569](#), [ADE5166](#), [ADE5169](#), [ADE5566](#), or [ADE5569](#) by clicking the **Evaluation Boards/Tools** link. When using the evaluation software, attach the P2 header of the evaluation board to the PC using the USB-to-UART board. The USB-to-UART driver must be installed. See the Installing the Drivers section for details on this procedure. Supply power to the EVAL-ADE7169EBZ-2/ADE5169EBZ-2 from the 9 V dc supply.

Note that when using the evaluation software, a low level hexadecimal file automatically downloads into the flash memory of the ADE71xx/ADE75xx/ADE51xx/ADE55xx and any code previously contained in this memory is erased.

### INSTALLING THE EVALUATION SOFTWARE

There are two evaluation software executables, one for the ADE71xx/ADE75xx family and one for the ADE51xx/ADE55xx family. Both executables can be found on the evaluation kit CD. Prior to running the evaluation software for the first time, it should be installed using the **setup.exe** application located in the **Installer** folder. This application launches the setup program that automatically installs all of the software components, including the uninstall program, and creates the required directories. To launch the software, click the **Start** button, select **Programs**, then **ADE71xxFxx Eval Software**, and then **ADE71xxFxx\_eval\_software**. Alternatively, select **ADE51xxFxx Eval Software**, and then **ADE51xxFxx\_eval\_software** for the ADE51xx/ADE55xx evaluation software.

### REMOVING THE EVALUATION SOFTWARE

The ADE71xx/ADE75xx/ADE51xx/ADE55xx evaluation programs are easily removed using the **Add or Remove Programs** feature in the **Control Panel**. Click the **Start** button and select **Control Panel**, then **Add or Remove Programs**, and select the ADE71xx or ADE51xx evaluation software. A dialog box appears. Click **OK** to start the removal process, and follow the instructions to finish.

### LAUNCHING THE EVALUATION SOFTWARE

When launching the ADE71xx/ADE75xx or ADE51xx/ADE55xx evaluation software, a series of pop-up windows appear in front of the evaluation software main menu, prompting you to download the evaluation hexadecimal file into the flash memory of the target IC. Follow these prompts to allow the low level assembly functions to be downloaded into the flash memory. This low level code provides the communication protocol for the evaluation software and it is essential to allow the evaluation software

to completely read and write to the internal register of the ADE71xx/ADE75xx/ADE51xx/ADE55xx.

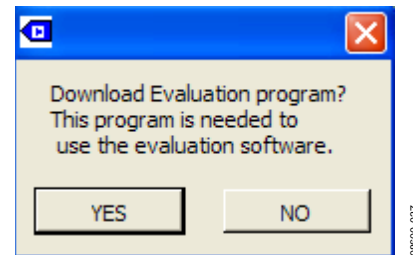

Figure 35. Download Evaluation Program Prompt

A final prompt is given prior to the mass erase of the flash memory. This prompt is shown in Figure 36. Any code that was previously stored in the flash memory of the target IC is erased at this time.

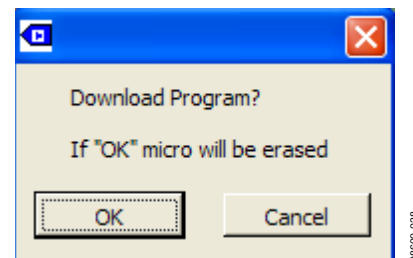

Figure 36. Erase Flash Memory Prompt

To download the hexadecimal file properly, place the part in serial download mode when the prompt shown in Figure 37 appears. This is achieved by pressing and holding the SDEN push-button, S2, while issuing a reset by pressing and releasing the RESET button, S3. The SDEN push-button, S2, should then be released.

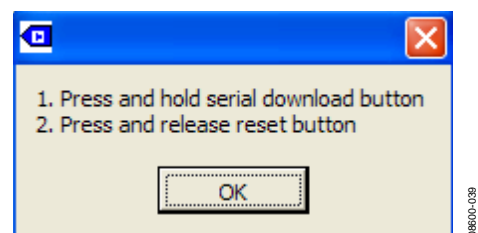

Figure 37. Enter Serial Download Mode

When the download is complete, the prompt shown in Figure 38 appears and the target IC should be reset by pressing the RESET button, S3.

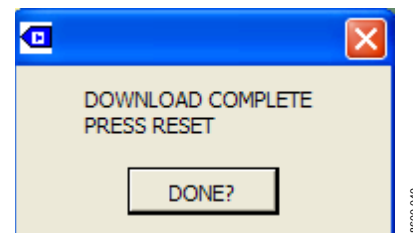

Figure 38. Download Complete



A reset is initiated by pressing and releasing the **RESET** push-button, S3. The main menu shown in Figure 42 is then displayed showing the respective evaluation software options.

**TROUBLESHOOTING LAUNCH**

**Code Previously Installed**

If the evaluation software detects a previous connection to the target IC, the prompt shown in Figure 39 is displayed.

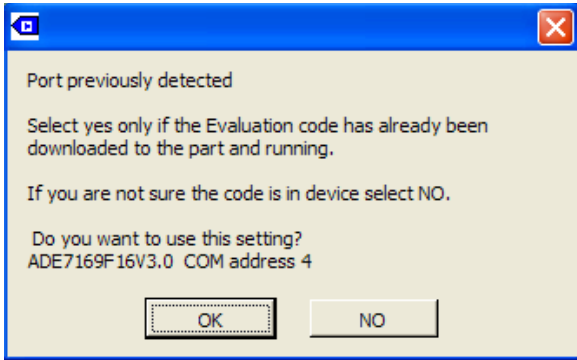

Figure 39. Code Previously Installed

If the code has already been downloaded to the target IC and the communication port address has not been changed, click the **OK** button to proceed to the main menu. If it is possible that the code may have been erased or the communication port changed, click **NO** and the prompt shown in Figure 40 appears.

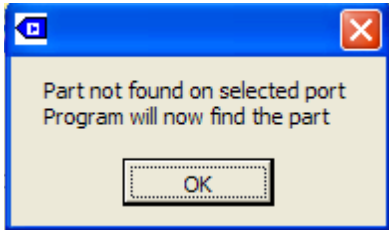

Figure 40. Redownload Code

Click **OK** and follow the prompts shown in Figure 35 through Figure 38 to redownload the code.

**Download Failure**

If the download does not complete properly, the prompt shown in Figure 41 appears.

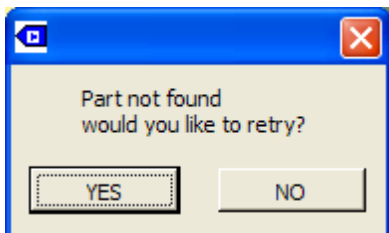

Figure 41. Download Failed

There are three reasons that a download may fail:

- The ADE71xx/ADE75xx/ADE51xx/ADE55xx is not powered up correctly.
- The communication failed.
- The part was not in serial download mode.

Ensure that the ADE71xx/ADE75xx/ADE51xx/ADE55xx is receiving 3.3 V from either the 9 V dc power supply or the 220 V line power. If using the 9 V dc power supply, this can be verified using an oscilloscope or voltmeter to probe both the  $V_{DD}$  and  $V_{INTD}$  pins.

Ensure that the USB-to-UART board connects to the P2 header and the necessary drivers are installed (see the Installing the Drivers section). To verify communication has been established, use the procedure outlined in the HyperTerminal Communication section.

Place the part in serial download mode once again by pressing the push-button sequence described in the Launching the Evaluation Software section.

**MAIN MENU**

Figure 42 shows the main menu of the ADE71xx/ADE75xx evaluation software. The COM port address and the ID string of the ADE71xx/ADE75xx part detected during the download process are displayed on this window. The left option box lists the functional blocks that can be tested using this software.

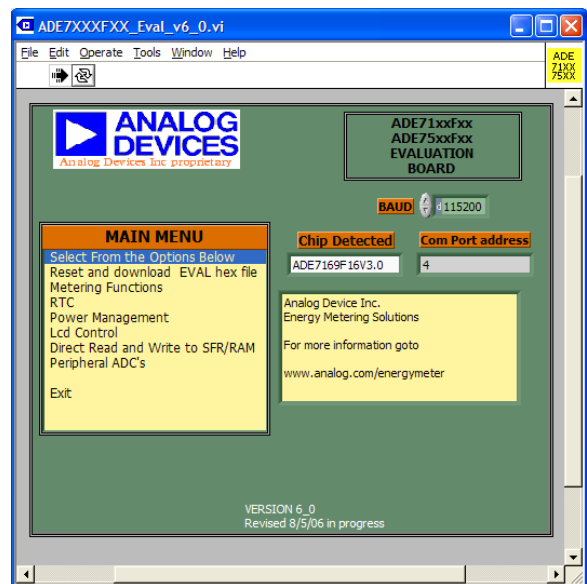

Figure 42. Main Menu

To issue a reset and redownload the low level hexadecimal code to the ADE71xx/ADE75xx, the **Reset and download EVAL hex file** option should be chosen. Selecting this option causes the series of prompts described in the Launching the Evaluation Software section to appear. The **Exit** option causes the evaluation software to stop running.

Each of the remaining **MAIN MENU** options, with the exception of the **Metering Functions** option, causes a new window to appear in front of the main menu window. Clicking the **EXIT** button in the new window brings you back to the main menu window. Register values are not reset by the program when a new window opens or closes. Clicking the **Metering Functions** option opens a secondary menu with more evaluation options. These options are described in the Metering Menu section.



From the **MAIN MENU**, the real time clock (RTC) can be configured and evaluated. The RTC window is displayed in Figure 43.

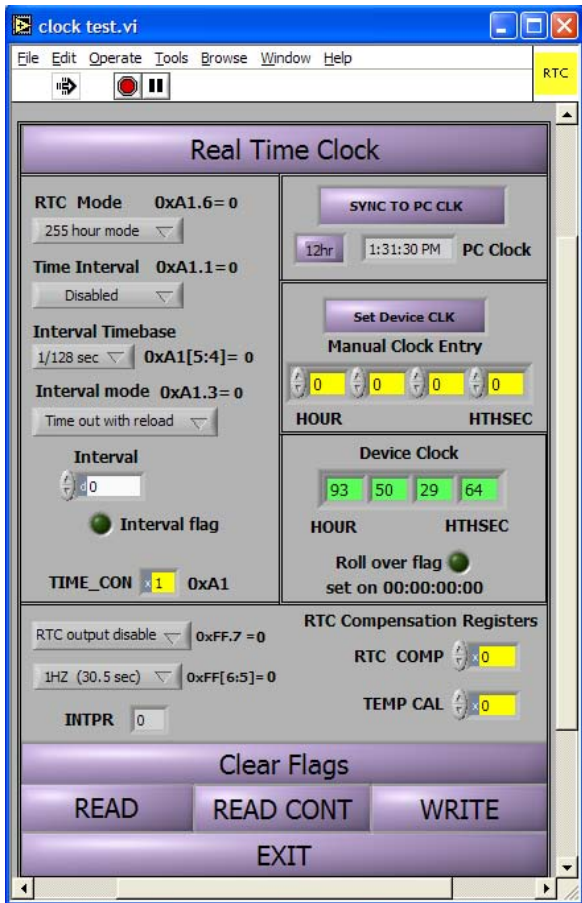

Figure 43. Real Time Clock Window

From this window, the RTC can be synchronized to the PC clock by clicking the **SYNC TO PC CLK** button. The RTC can be continually monitored by clicking the **READ CONT** button, although it should be noted that the update rate may be limited by the PC and LabVIEW speed.

Clicking **Power Management** under **MAIN MENU** allows you to view the block diagram of the power sources to the ADE71xx/ADE75xx in the power management window. This window is shown in Figure 44.

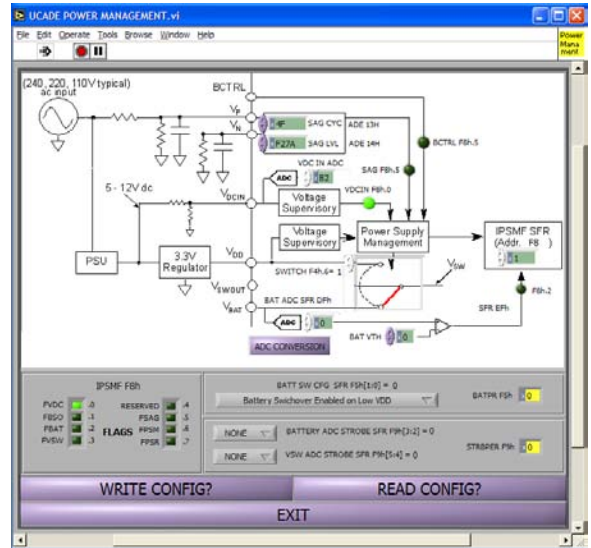

Figure 44. Power Management Window

The user can view or change the current power configuration with this option.

The LCD window has a series of tabs that can be selected to configure and view the LCD panel display and the internal RAM. Figure 45 shows the **3 PHASE** tab that depicts the LCD panel that is used on the ADE71xx/ADE75xx reference board. When the segments have been set up and written to the LCD memory by clicking the **WRITE** button, the LCD panel on the ADE71xx/ADE75xx reference board should be identical to the **3 PHASE** tab on the evaluation software.

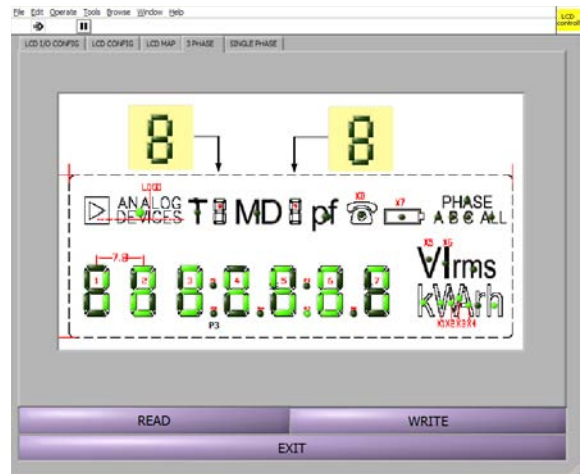

Figure 45. LCD Window

**Metering Menu**

Selecting the **Metering Functions** option under **MAIN MENU** opens the secondary metering menu window shown in Figure 46.

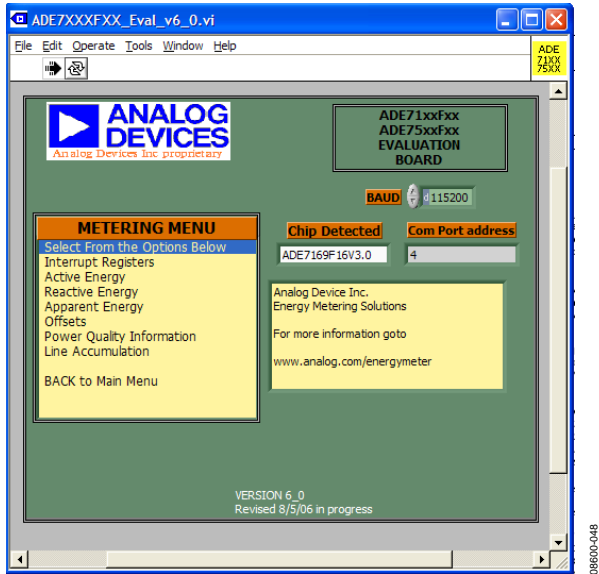

Figure 46. Metering Menu

From this window, many of the energy metering functions can be evaluated. Clicking each of the options shown under **METERING MENU** opens a new window in front of the metering menu window. Clicking the **EXIT** button in the new window brings you back to the metering menu window. From **METERING MENU**, you can return to the main menu window by clicking the **BACK to Main Menu** option. Opening or closing new windows does not cause the ADE71xx/ADE75xx registers to reset.

The **Interrupt Registers** window allows you to set up the interrupt masks and view the status bits described in the ADE71xx/ADE75xx data sheet. The **Power Quality Information** window allows you to read the registers associated with the current and voltage readings, along with monitoring the voltage channel frequency, zero crossings, and line voltage sag events. The offset calibration registers can be written to in the **Offsets** window. In all windows, any changes made are not written to the part until the corresponding **WRITE** button is clicked.

**Active, Reactive, and Apparent Energy**

The **Active Energy**, **Reactive Energy**, and **Apparent Energy** options allow you to view the data path for each of these measurements. The data path for the active energy data path is shown in Figure 47.

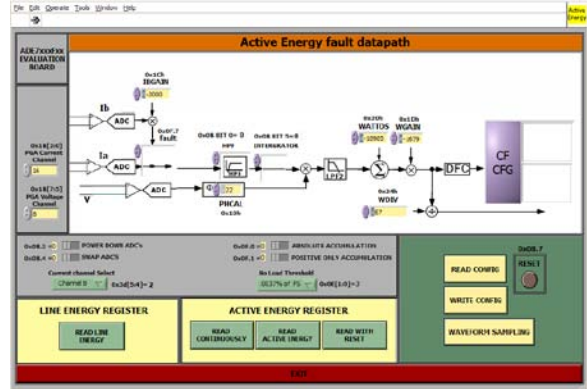

Figure 47. Active Energy Window

Similar windows are available for the **Reactive Energy** and **Apparent Energy** data paths. From these windows, the data paths can be configured and reset by writing to the necessary registers. Changes made on the data path window are not written to the part until the **WRITE CONFIG** button is clicked. The energy data can also be read in either normal mode or line cycle accumulation mode.

From the active energy, reactive energy, and apparent energy windows, the calibration frequency output can be configured using the **CF CFG** button. Clicking this button opens the window shown in Figure 48.

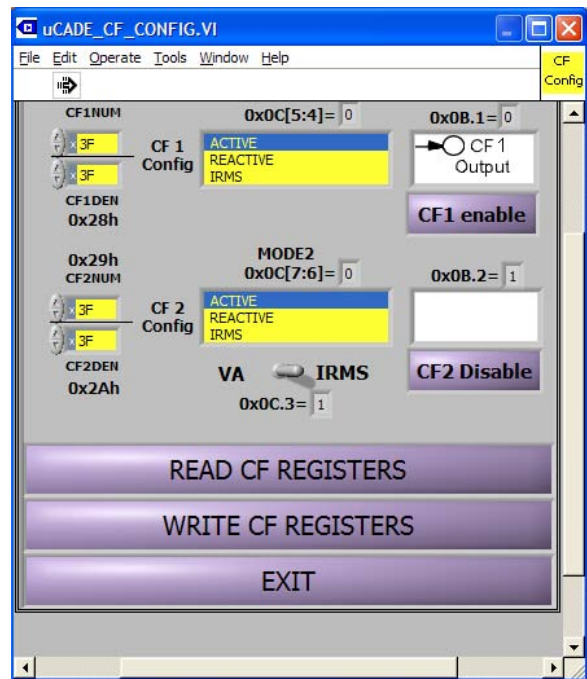

Figure 48. Calibration Frequency

The two CF outputs can be configured and enabled from this window. Once again, any changes made in the window are not written to the part until the **WRITE CF REGISTERS** button is clicked.

### Waveform Sampling

The waveform sampling window is accessible from the active energy, reactive energy, and apparent energy windows and by selecting the **Line Accumulation** option under **METERING MENU**. Figure 49 shows the waveform sampling window.

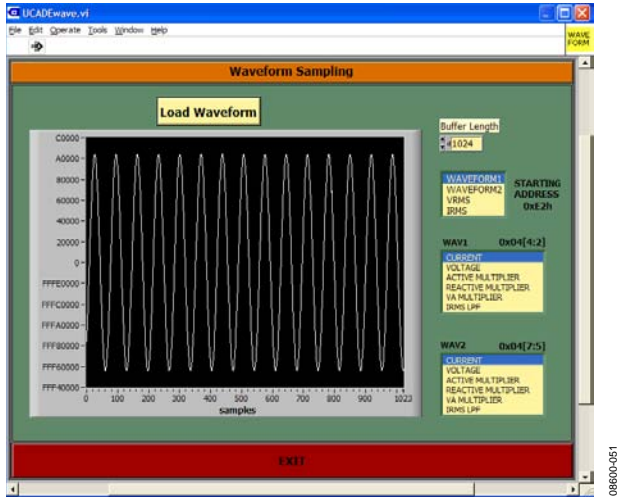

Figure 49. Waveform Sampling Window

The waveform sampling window allows you to view multiple waveforms in the signal chain, including the current, voltage, active, reactive and apparent multiplier outputs, along with the output of the IRMS LPF. The samples are taken at a speed of 3.2 kSPS. The number of samples is defined by adjusting the value in the **Buffer Length** box.

EVALUATION BOARD SCHEMATIC AND ARTWORK

650-00980

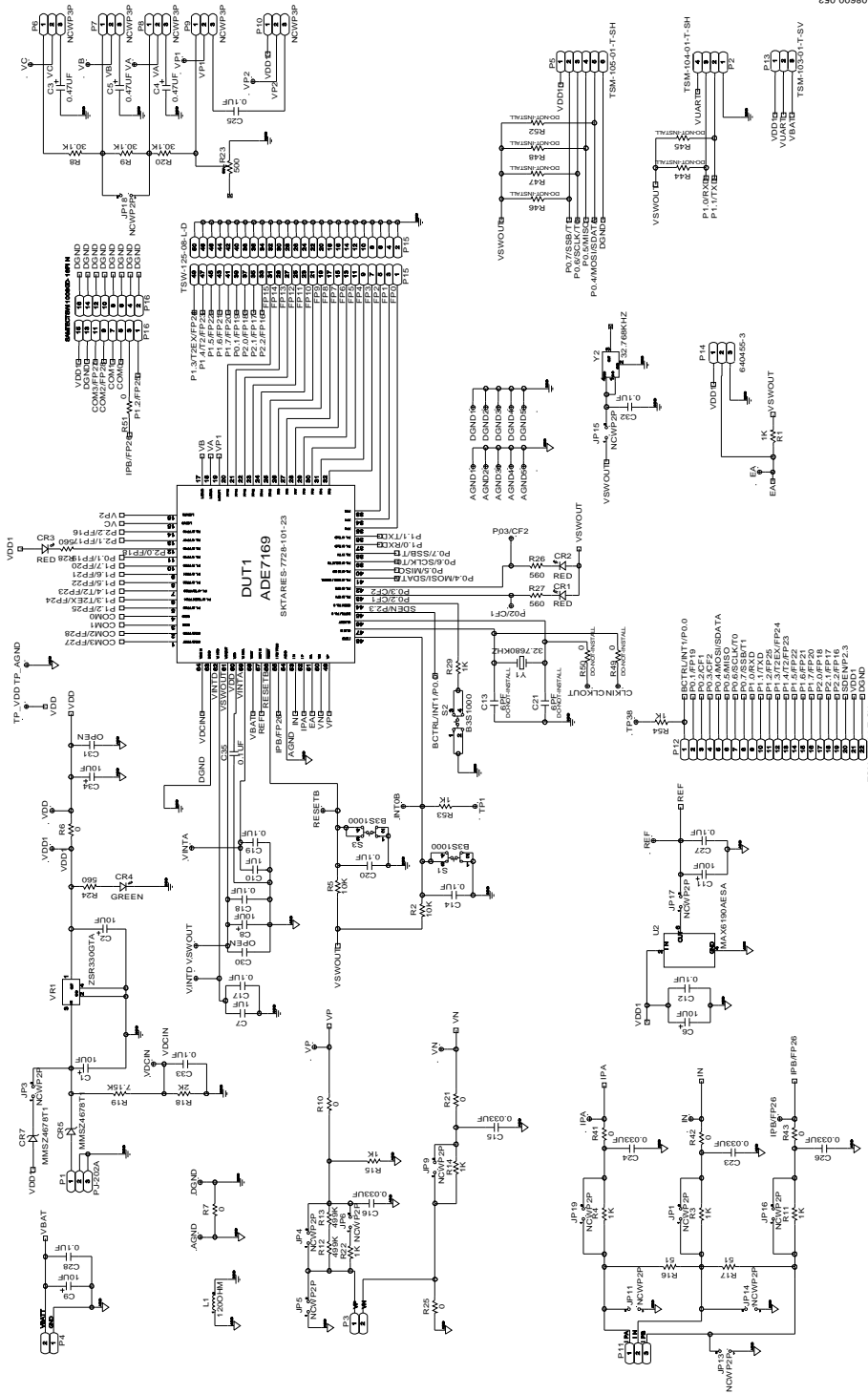

Figure 50.

PCB LAYOUT—COMPONENT PLACEMENT



SILKSCREEN PRIMARY  
08-013447-03  
REV A

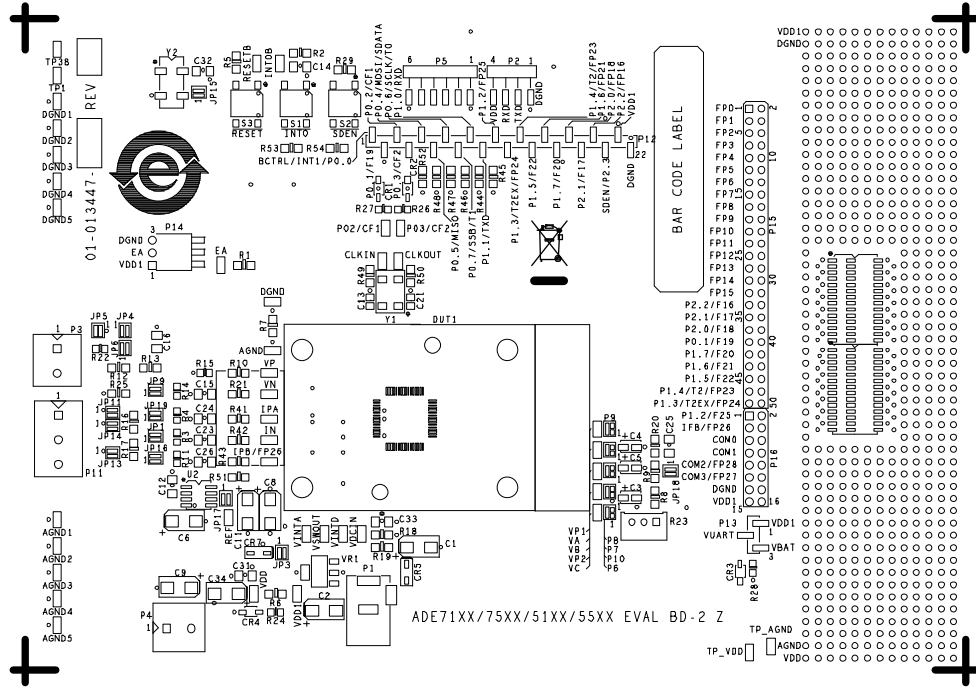

Figure 51. Silkscreen

08600-054

PCB LAYOUT—COMPONENT SIDE

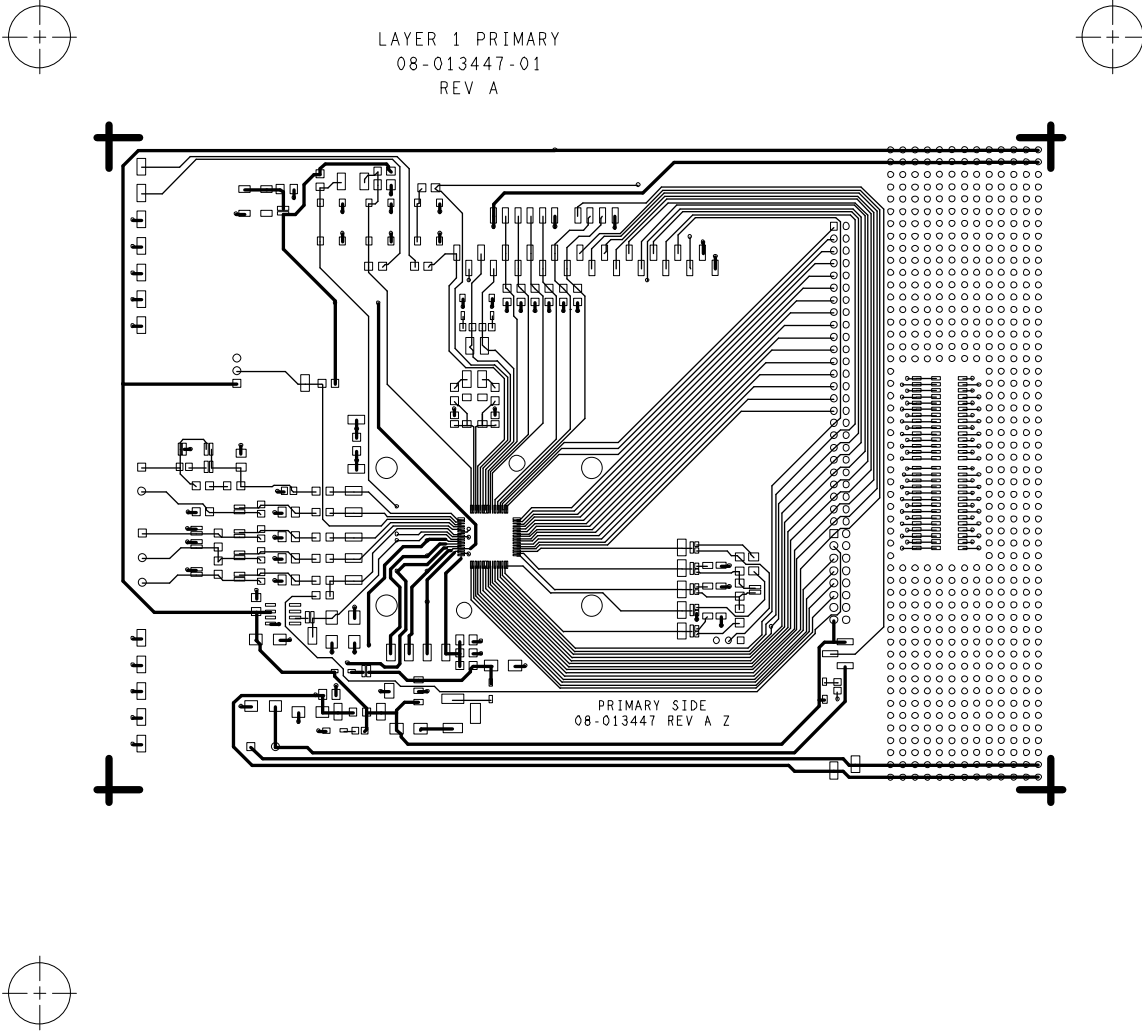

Figure 52. Layer 1

PCB LAYOUT—SOLDER SIDE

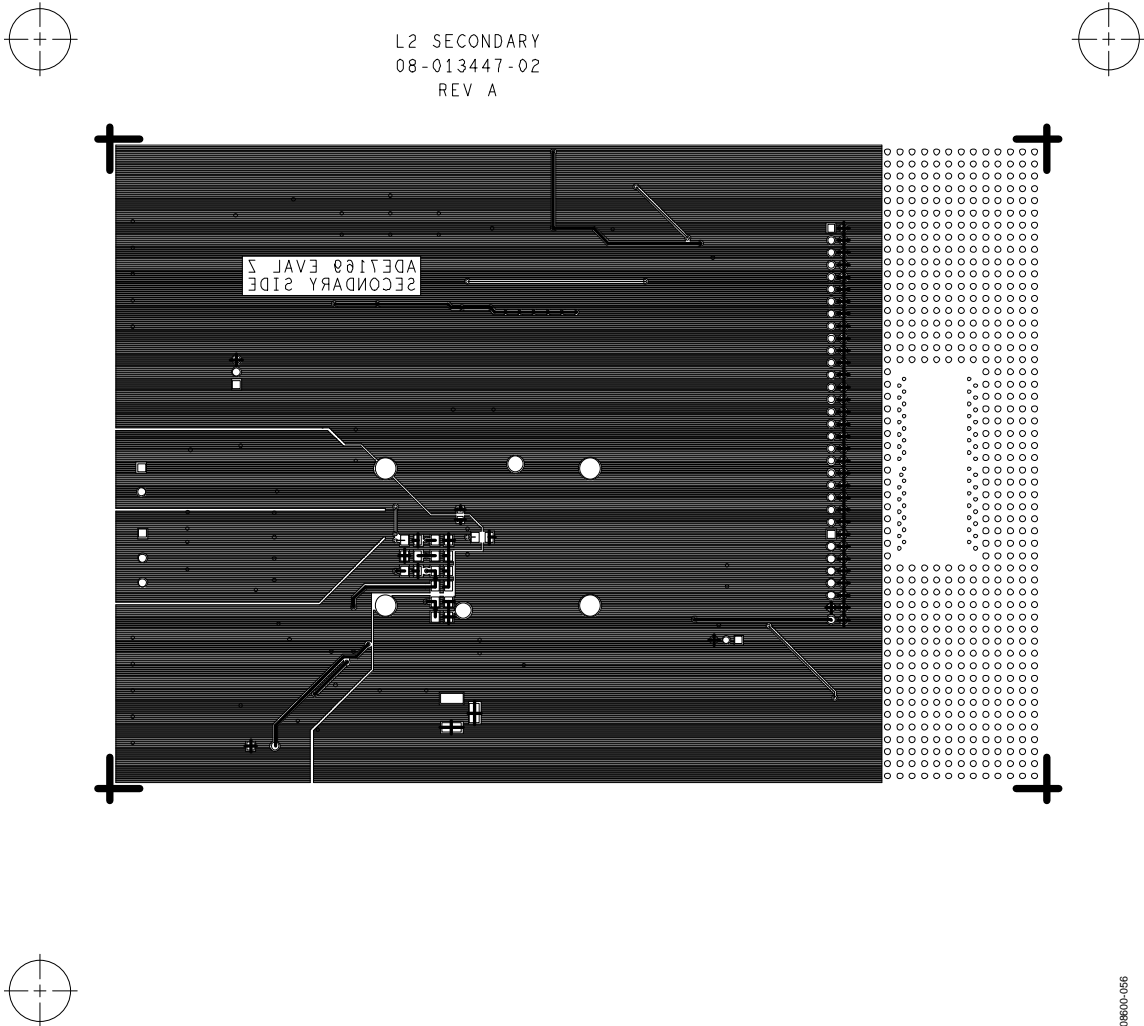

Figure 53. Layer 2



## ORDERING INFORMATION

## BILL OF MATERIALS

Table 4. Components Listing

Qty.	Reference Designator	Description	Supplier/Number
7	C1 to C2, C6, C8 to C9, C11, C34	Tantalum, 10 $\mu$ F, 16 V, 20% SMD capacitor	Digi-Key: PCT3106CT-ND
3	C3 to C5	Tantalum, 0.47 $\mu$ F, 25 V, 20% SMD capacitor	Digi-Key: PCS5474TR-ND
2	C7, C10	1 $\mu$ F, 50 V, ceramic 1206 SMD capacitor	AVX 1206YG1052AT2A
12	C12, C14, C17 to C20, C25, C27 to C28, C32 to C33, C35	0.1 $\mu$ F, 50 V, ceramic X7R 1206 SMD capacitor	Digi-Key: PCC104BCT-ND
2	C13, C21	6 pF, 50 V, ceramic NP0 0805 SMD capacitor	DNI
5	C15 to 16, C23 to C24, C26	33,000 pF, 50 V, ceramic X7R 1206 SMD capacitor	Digi-Key: 311-1177-1-ND
2	C30 to C31	Open	DNI
3	CR1 to CR3	Clear green LED LC gull wing SMD	Digi-Key: L62705CT-ND
1	CR4	Clear green LED LC gull wing SMD	Digi-Key: L62705CT-ND
2	CR5, CR7	Zener diode 1.8 V 500 mW SOD-123	Digi-Key: MMSZ4678T1GOSCT-ND
1	L1	Ferrite bead, 300 mA 150 $\Omega$ 1806 SMD	Digi-Key: 240-1030-1-ND
1	P1	Power jack connector 2.1 $\times$ 5.5 mm	Digi-Key: CP-202AH-ND
1	P2	Right angle 4-position SMD header 0.100	Samtec TSM-104-01-T-SH
2	P3 to P4	2-position PCB board connector 5 mm	WIELAND ELECTRIC 25.161.0253.0
1	P5	Right angle 6-position SMD header 0.100	Samtec TSM-106-01-T-SH
1	P11	3-position PCB board connector 5 mm	WIELAND ELECTRIC 25.161.0353.0
1	P12	Vertical 22-position SMD header 0.100	Samtec TSM-122-01-T-SV
1	P13	Vertical 3-position SMD header 0.100	Samtec TSM-133-01-T-SV
1	P14	Right angle 3-position 0.100 tin connector	Digi-Key: A19461-ND
1	P15	50-position header, 0.100" double row gold	Digi-Key: SAM1041-25-ND
1	P16	20-position header, 0.100" double row gold	Digi-Key: SAM1037-10-ND
4	R1, R29, R53 to R54	1.00 k $\Omega$ , 1/4 W, 1%, 1206 SMD resistor	Digi-Key: P1.00KFCT-ND
2	R2, R5	10.0 k $\Omega$ , 1/4 W, 1%, 1206 SMD resistor	Digi-Key: P10.0KFCT-ND
6	R3 to R4, R11, R14 to R15, R22	1 k $\Omega$ precision chip resistors, 0.1 W, 0.1%, 10 ppm, 0805 SMD	TYCO RN73C2A1K0BTG
9	R6 to R7, R10, R21, R25, R41 to R43, R51	0 $\Omega$ , 1/4 W 5% 1206 SMD resistor	Digi-Key: P0.0ECT-ND
3	R8 to R9, R20	30.1 k $\Omega$ , 1/4 W, 1% 1206 SMD resistor	Digi-Key: P30.1KFCT-ND
2	R12 to R13	499 k $\Omega$ , 1/4 W, 1% 1206 SMD resistor	Digi-Key: P499KFCT-ND
2	R16 to R17	51.1 $\Omega$ , 1/4 W, 1% 1206 SMD resistor	Digi-Key: P51.1FTR-ND
1	R18	2.00 k $\Omega$ , 1/4 W, 1% 1206 SMD resistor	Digi-Key: P2.00KFTR-ND
1	R19	7.15 k $\Omega$ , 1/4 W, 1% 1206 SMD resistor	Digi-Key: P7.15KFTR-ND
1	R23	Multiturn trimmer potentiometer, 500 $\Omega$ , standoffs, vertical adjust 3/8	Digi-Key: 3299W-501LF-ND
4	R24, R26 to R28	560 $\Omega$ , 1/8 W, 0.1%, 0805 SMD resistor	Digi-Key: P560ZTR-ND
6	R44 to R48, R52	1.00 k $\Omega$ , 1/8 W, 1%, 0805 SMD resistor	DNI
2	R49 to R50	0 $\Omega$ , 1/8 W, 5%, 0805 SMD resistor	DNI
3	S1 to S3	Tactile switch, 6 mm SMD	Digi-Key: SW415-ND
1	U2	IC reference voltage LDO 8-SOIC	Digi-Key: MAX6190AESA+-ND
1	VR1	3.3 V, 200 mA, SOT-223 voltage regulator	Digi-Key: ZSR330GCT-ND
1	Y1	Crystal 32.768 kHz, 6.0 pF SMD	Digi-Key: SE2417TR-ND
1	Y2	Crystal oscillator 32.768 kHz, 5 ppm $\pm$ 23 ppm SMD	Digi-Key: SE3618TR-ND

**NOTES**

## NOTES

## ESD CAUTION

**ESD (electrostatic discharge) sensitive device.**

Charged devices and circuit boards can discharge without detection. Although this product features patented or proprietary protection circuitry, damage may occur on devices subjected to high energy ESD. Therefore, proper ESD precautions should be taken to avoid performance degradation or loss of functionality.

Evaluation boards are only intended for device evaluation and not for production purposes. Evaluation boards are supplied "as is" and without warranties of any kind, express, implied, or statutory including, but not limited to, any implied warranty of merchantability or fitness for a particular purpose. No license is granted by implication or otherwise under any patents or other intellectual property by application or use of evaluation boards. Information furnished by Analog Devices is believed to be accurate and reliable. However, no responsibility is assumed by Analog Devices for its use, nor for any infringements of patents or other rights of third parties that may result from its use. Analog Devices reserves the right to change devices or specifications at any time without notice. Trademarks and registered trademarks are the property of their respective owners. Evaluation boards are not authorized to be used in life support devices or systems.