



MODEL NO. : TM084SDHG01

ISSUED DATE: 2012-05-23

VERSION : Ver 1.0

Preliminary Specification

Final Product Specification

Customer : _____

Approved by	Notes

SHANGHAI TIANMA Confirmed :

Prepared by	Checked by	Approved by
Longping.Deng	Ling.Shen	Ruiyuan.Zhou

This technical specification is subjected to change without notice

The information contained herein is the exclusive property of SHANGHAI AVIC OPTOELECTRONICS Corporation, and shall not be distributed, reproduced, or disclosed in whole or in part without prior written permission of SHANGHAI AVIC OPTOELECTRONICS Corporation.



Table of Contents

Table of Contents.....	2
Record of Revision.....	3
1 General Specifications.....	4
2 Input/Output Terminals.....	5
3 Absolute Maximum Ratings.....	6
4 Electrical Characteristics.....	8
5 Timing Chart.....	11
6 Optical Characteristics.....	14
7 Environmental / Reliability Test.....	17
8 Mechanical Drawing.....	18
9 Packing drawing.....	19
10 Precautions for Use of LCD Modules.....	20

The information contained herein is the exclusive property of SHANGHAI AVIC OPTOELECTRONICS Corporation, and shall not be distributed, reproduced, or disclosed in whole or in part without prior written permission of SHANGHAI AVIC OPTOELECTRONICS Corporation.



Record of Revision

Rev	Issued Date	Description	Editor
1.0	2012-5-23	Preliminary Specification	Longping.Deng

The information contained herein is the exclusive property of SHANGHAI AVIC OPTOELECTRONICS Corporation, and shall not be distributed, reproduced, or disclosed in whole or in part without prior written permission of SHANGHAI AVIC OPTOELECTRONICS Corporation.



1 General Specifications

	Feature	Spec
Display Spec.	Size	8.4 inch
	Resolution	800(RGB) x 600
	Interface	LVDS 6/8 bit
	Color Depth	16.7M
	Technology Type	a-Si TFT
	Pixel Pitch (mm)	0.213×0.213
	Pixel Configuration	R.G.B. Vertical Stripe
	Display Mode	TM,NW
	Surface Treatment	Anti Glare
	Viewing Direction	6 o'clock
	Gray Scale Inversion Direction	12 o'clock
Mechanical Characteristics	LCM (W x H x D) (mm)	203x 142.5 x 5.7
	Active Area(mm)	170.4 (W) X127.8(H)
	With /Without TSP	Without TSP
	Weight (g)	TBD
	LED Numbers	27 LEDS

Note 1: Viewing direction for best image quality is different from TFT definition. There is a 180 degree shift.

Note 2: Requirements on Environmental Protection: Q/S0002

Note 3: LCM weight tolerance: +/- 5%

The information contained herein is the exclusive property of SHANGHAI AVIC OPTOELECTRONICS Corporation, and shall not be distributed, reproduced, or disclosed in whole or in part without prior written permission of SHANGHAI AVIC OPTOELECTRONICS Corporation.



2 Input/Output Terminals

2.1 CN1 of FPC

Connector type: 107A20-0021RA-G3-R (Hirose)

Pin	Symbol	I/O	Description	Remark
1	VDD	P	Power supply	
2	VDD	P	Power supply	
3	UD	I	Vertical Reverse Scan Control	
4	LR	I	Horizontal Reverse Scan Control	
5	RxIN1-	I	Negative data 1 for LVDS signal input	
6	RxIN1+	I	Positive data 1 for LVDS signal input	
7	GND	P	Ground	
8	RxIN2-	I	Negative data 2 for LVDS signal input	
9	RxIN2+	I	Positive data 2 for LVDS signal input	
10	GND	P	Ground	
11	RxIN3-	I	Negative data 3 for LVDS signal input	
12	RxIN3+	I	Positive data 3 for LVDS signal input	
13	GND	P	Ground	
14	RxCLKIN-	I	negative clock for LVDS signal input	
15	RxCLKIN+	I	Positive clock for LVDS signal input	
16	GND	P	Ground	
17	SEL68	I	LVDS 6/8 bit selection control	
18	NC	I	No connection	
19	RxIN4-	I	Negative data 4 for LVDS signal input	
20	RxIN4+	I	Positive data 4 for LVDS signal input	

I---Input, O---Output, P--- Power/Ground

Table 2.1 terminal pin assignments

The information contained herein is the exclusive property of SHANGHAI AVIC OPTOELECTRONICS Corporation, and shall not be distributed, reproduced, or disclosed in whole or in part without prior written permission of SHANGHAI AVIC OPTOELECTRONICS Corporation.

**2.2 CN2 pin assignment (Backlight interface)**

Connector type: 3808K-F04N-02R (Entry)

Pin	Symbol	I/O	Description	Remark
1	VBL	P	Backlight Power supply , 12V input	
2	PGND	P	Ground	
3	BL_EN	I	Enable : 3.3V for backlight on ; 0V for backlight off	
4	Dimming	I	Adjust the luminance of LED's	

Note1: CN2 Matching Connector type: H208K-P04N-02B (Entry)

Table 2.2 Backlight terminal pin assignments



3 Absolute Maximum Ratings

GND=0V, Ta = 25°C

Item	Symbol	MIN	MAX	Unit	Remark
Power Voltage	VDD	-0.5	5.0	V	
	VBL	-0.3	24	V	
Input voltage	V _{IN}	-0.5	5.0	V	Note2
Operating Temperature	Top	-20	70	°C	Note1
Storage Temperature	Tst	-30	80	°C	Note1

Note1: The parameter is for driver IC (gate driver, source driver) only.

Note2: Signals include RxIN, RxCLK, SEL68, UD, LR, EN, Dimming.

Table 3.1 absolute maximum rating

The information contained herein is the exclusive property of SHANGHAI AVIC OPTOELECTRONICS Corporation, and shall not be distributed, reproduced, or disclosed in whole or in part without prior written permission of SHANGHAI AVIC OPTOELECTRONICS Corporation.



4 Electrical Characteristics

4.1 Recommended Operating Condition

VCC=3.3V, GND=0V, Ta = 25°C

Item	Symbol	Min	Typ	Max	Unit	Remark
POWER Supply Voltage	VDD	3.00	3.30	3.60	V	
Differential input high threshold voltage	R_{xVTH}			+0.1	V	$R_{xVCM} = 1.2V$
Differential input low threshold voltage	R_{xVTL}	-0.1			V	
Input voltage range (singled-end)	R_{xVIN}	0		2.4	V	
Differential input common mode voltage	R_{xVCM}	$ V_{ID} /2$		$2.4- V_{ID} /2$	V	
Differential input voltage	$ V_{ID} $	0.2		0.6	V	
Current of VDD Power supply	I _{VDD}	-	TBD	TBD	mA	Note1
Power consumption of VDD	W _{VDD}	-	TBD	-	mW	

Table 4.1 LCD module electrical characteristics

Note1: To test the current dissipation, use "all Black Pattern".

Single-end Signals

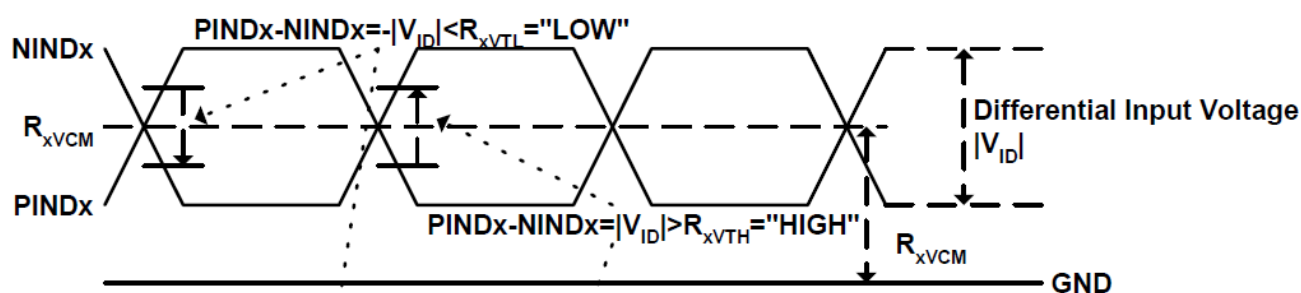

Differential Signal

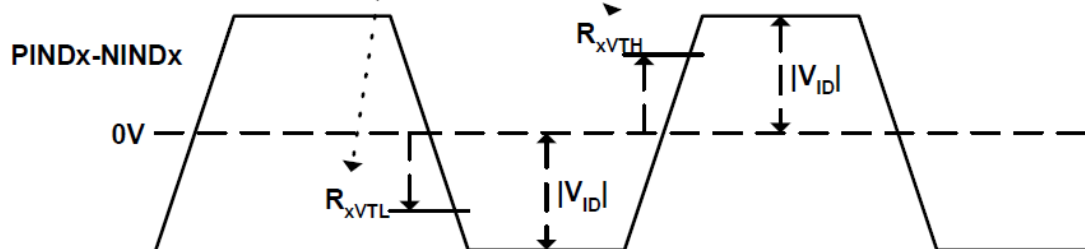

The information contained herein is the exclusive property of SHANGHAI AVIC OPTOELECTRONICS Corporation, and shall not be distributed, reproduced, or disclosed in whole or in part without prior written permission of SHANGHAI AVIC OPTOELECTRONICS Corporation.



4.2 Backlight Unit Driving Condition

LEDGND=GND=0V, Ta = 25°C

Item	Symbol	Min	Typ	Max	Unit	Remark
Voltage of LED driver circuit	VBL	11.5	12	12.5	V	
Current of LED driver circuit	IBL	-	TBD	-	mA	
Power Consumption	W_{BL}	-	TBD	-	mW	
Dimming Signal frequency	Fdimming	0.1		100	KHz	
Dimming Signal duty	100Hz~10KHz	-	0	-	100	%
	10KHz~100KHz	-	10	-	100	%
LED Life time	-	--	(50000)	--	H	

Table 4.2 LED backlight characteristics

Note 1: If LED is driven by high current, high ambient temperature & humidity condition. The life time of LED will be reduced. Operating life means brightness goes down to 50% initial brightness. Typical operating life time is estimated data

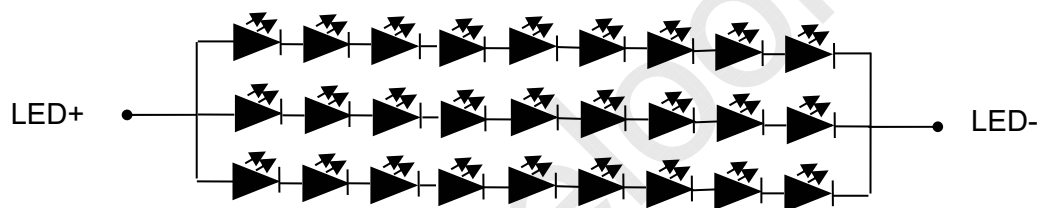
**Figure4.1 LED connection of backlight**



4.3 BLOCK DIAGRAM

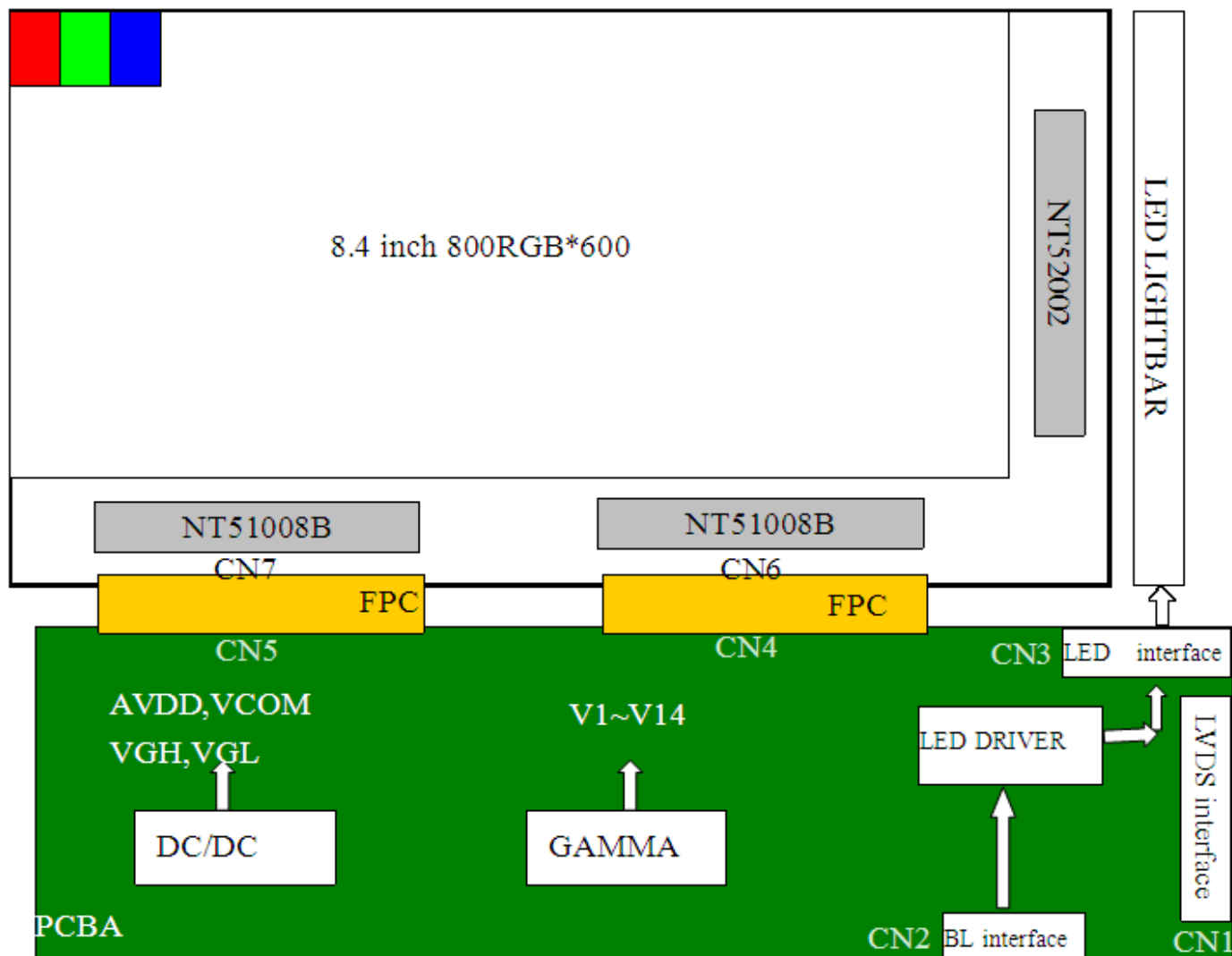



5 Timing Chart

5.1 TFT-LCD Input Timing

VCC=3.3V, GND=0V, Ta=25°C

Parameter	Symbol	Min	Typ	Max	Unit	Remark
DCLK	Fclk	34.5	39.6	50.4	MHz	Tclk=1/Fclk
	Tclk	16	25.3	30.7	ns	
HSYNC	TH	900	1000	1200	Tclk	
	THD	-	800	-	Tclk	
	Thwh	1	-	40	Tclk	
	Thbp	-	88	-	Tclk	
	Thfp	12	112	312	Tclk	
VSYNC	TV	640	660	700	TH	
	TVD	-	480	-	TH	
	Tvwh	1	-	20	TH	
	Tvbp	-	39	-	TH	
	Tvfp	1	21	61	TH	

Table 5.1 TCON input timing(HV mode)

5.2 Recommended Timing Setting Of TCON

TCON (Embedded In Source IC) Input timing at DE mode

VCC=3.3V, GND=0V, Ta=25°C

	Parameter	Symbol	Min.	Typ.	Max.	Unit	Remark
Dclk frequency		Fclk	32.6	39.6	62.4	MHz	Tclk=1/Fclk
Horizontal section	Horizontal total	TH	890	1000	1300	Tclk	
	Horizontal blanking	THC	90	200	500	Tclk	
	Valid Data Width	THD	-	800	-	Tclk	
Vertical section	Frame rate	-	-	60	-	Hz	
	Vertical total	TV	610	660	800	TH	
	Vertical blanking	TVC	10	60	200	TH	
	Valid Data Width	TVD	-	600	-	TH	

Table 5.2 TCON input timing (DE mode)

The information contained herein is the exclusive property of SHANGHAI AVIC OPTOELECTRONICS Corporation, and shall not be distributed, reproduced, or disclosed in whole or in part without prior written permission of SHANGHAI AVIC OPTOELECTRONICS Corporation.



5.3 LVDS Input Data Format

6bit LVDS input (HSD='H')

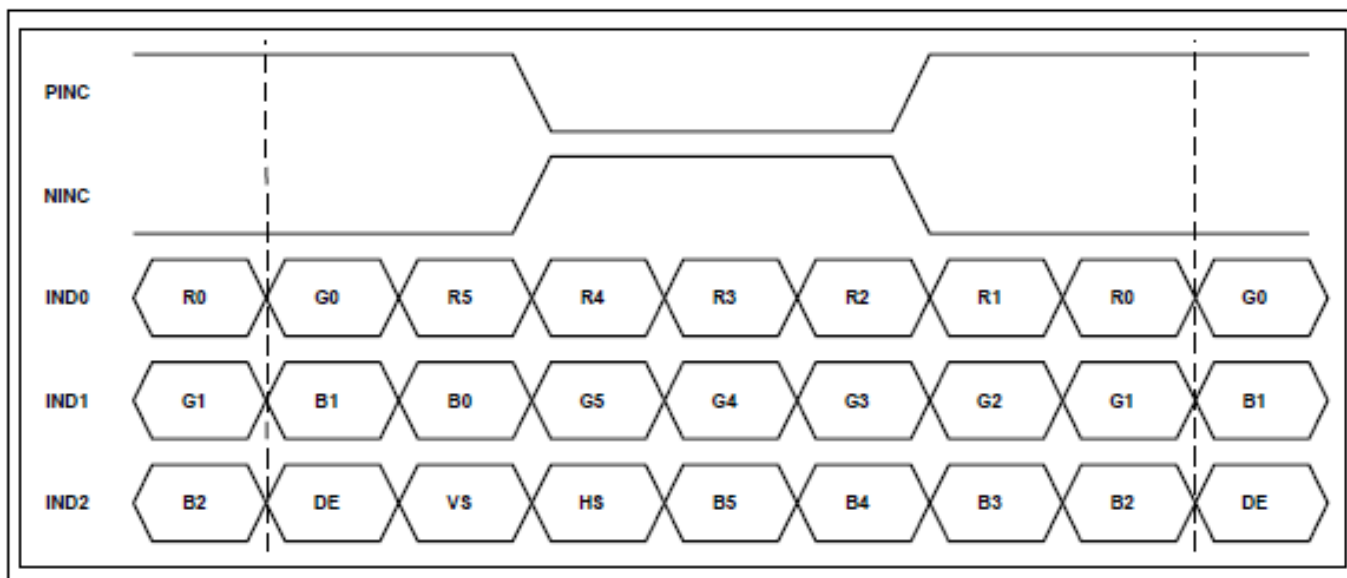

8-bit LVDS input (HSD='L')

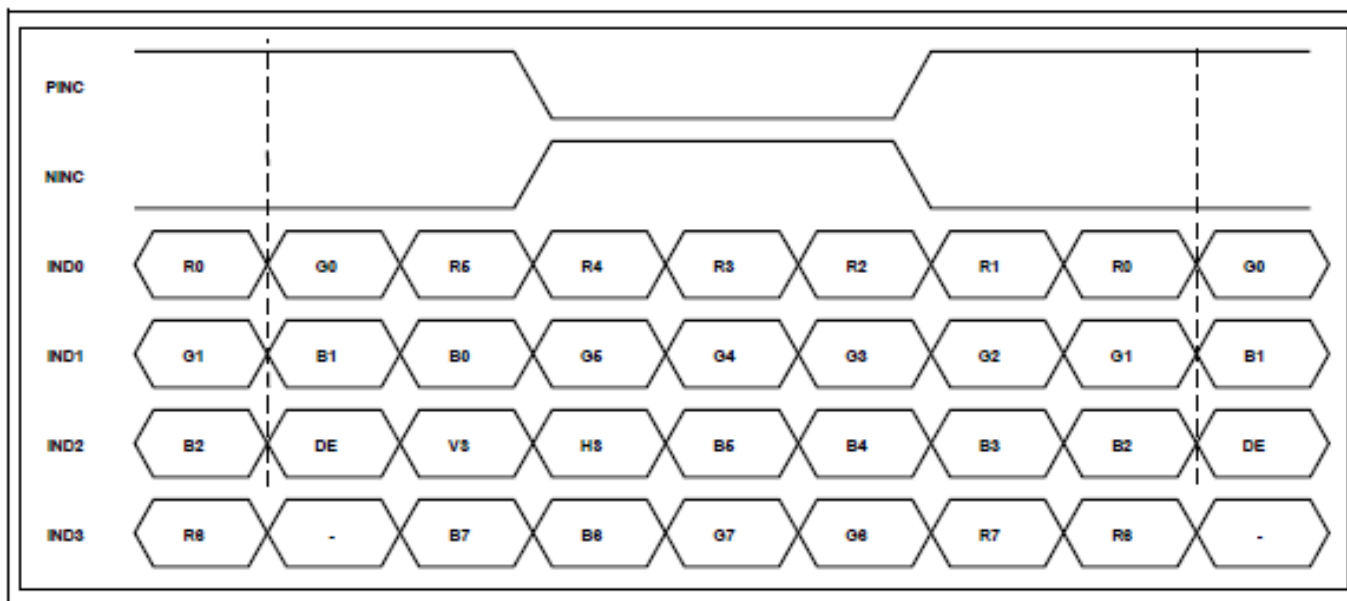

Figure5.1 LVDS input data mapping



5.4 Input signal AC timing

Parameter	Symbol	Min.	Typ.	Max.	Unit	Remark
Clock frequency	R_{XFCLK}	32.6	39.6	62.4	MHz	
Clock high time	T_{LVCH}		$4/(7 * R_{XFCLK})$		nS	
Clock low time	T_{LVCL}		$3/(7 * R_{XFCLK})$		nS	

Table 5.3 LVDS clock Input timing

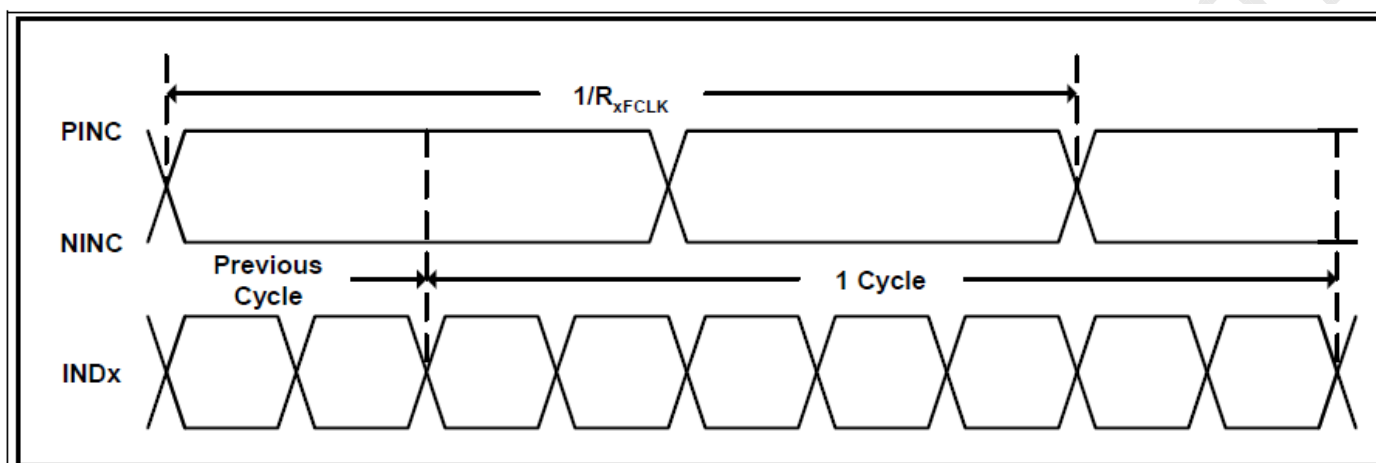

Figure 5.2 Input signal AC timing

5.5 POWER ON/OFF SEQUENCE

Item	Symbol	Min	Typ	Max	Unit	Remark
VDD 3.3V to signal starting	Tp1	5	-	50	ms	
VDD rising time	Tr	0.1	-	5	ms	
Signal starting to backlight on	Tp2	150	-	-	ms	
Signal off to VDD 0V	Tp3	5	-	50	ms	
Backlight off to signal off	Tp4	150	-	-	ms	

Table 5.4 POWER ON/OFF SEQUENCE

The information contained herein is the exclusive property of SHANGHAI AVIC OPTOELECTRONICS Corporation, and shall not be distributed, reproduced, or disclosed in whole or in part without prior written permission of SHANGHAI AVIC OPTOELECTRONICS Corporation.

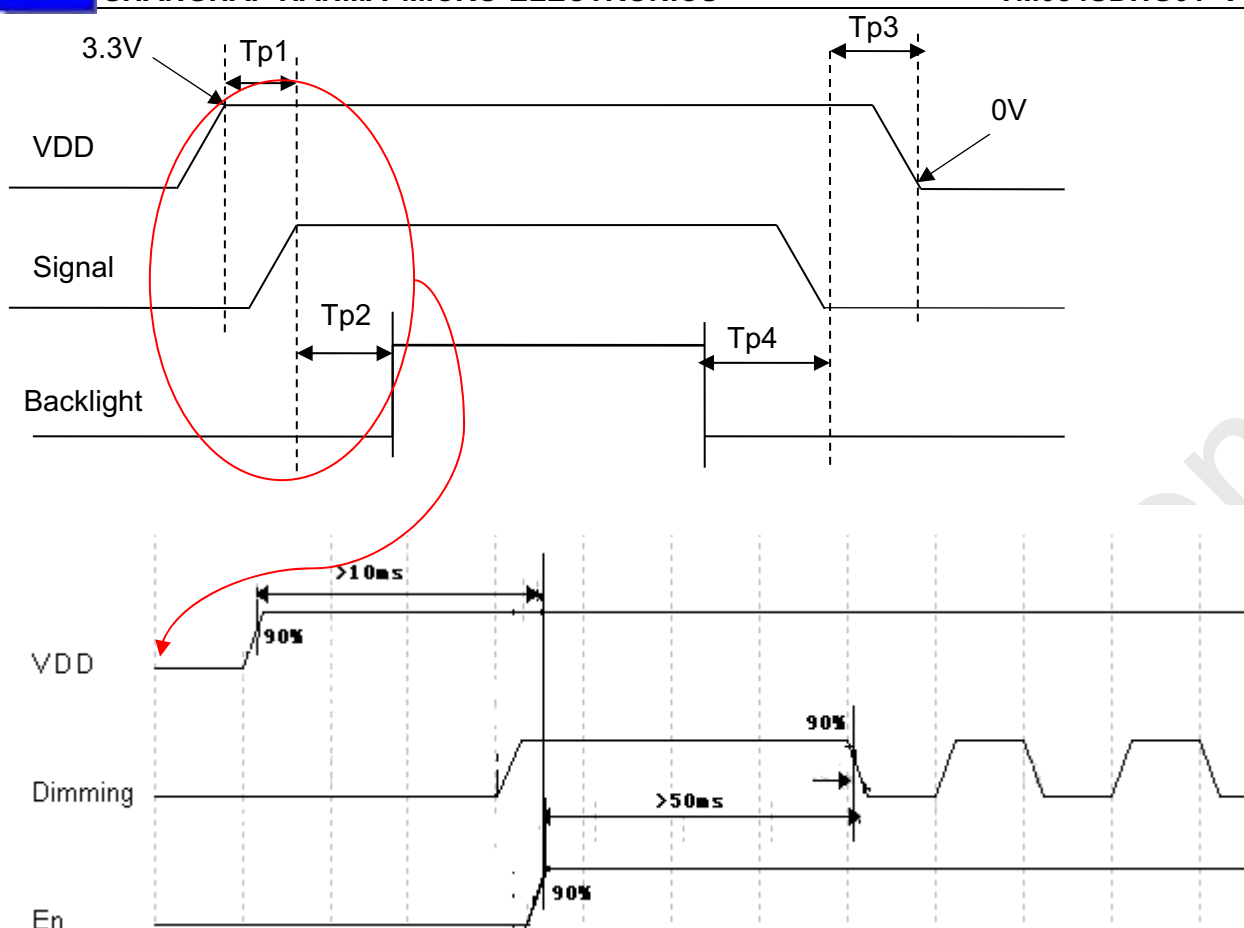

Figure5.3 Interface power on/off sequence



6 Optical Characteristics

Ta=25°C

Item	Symbol	Condition	Min	Typ	Max	Unit	Remark
View Angles	θT	$CR \geq 10$	50	60	-	Degree	Note 2
	θB		60	70	-		
	θL		60	70	-		
	θR		60	70	-		
Contrast Ratio	CR	$\theta=0^\circ$	400	500	-		Note1 Note3
Response Time	T_{ON}	25°C	-	25	-	ms	Note1 Note4
	T_{OFF}						
Chromaticity	White	Backlight is on	x	0.260	0.310	0.360	Note1 Note5
			y	0.280	0.330	0.380	
	Red		x	TBD	TBD	TBD	
			y	TBD	TBD	TBD	
	Green		x	TBD	TBD	TBD	
			y	TBD	TBD	TBD	
	Blue		x	TBD	TBD	TBD	
			y	TBD	TBD	TBD	
Uniformity	U		-	75	-	%	Note1 Note6
NTSC			-	50	-	%	Note 5
Luminance (Without TP)	L		200	250	-	cd/m ²	Note1 Note7

Test Conditions:

1. $I_F=160\text{ mA}$, $V_F=9.6\text{ V}$ and the ambient temperature is $25\pm 2^\circ\text{C}$. humidity is $65\pm 7\%$
2. The test systems refer to Note 1 and Note 2.

The information contained herein is the exclusive property of SHANGHAI AVIC OPTOELECTRONICS Corporation, and shall not be distributed, reproduced, or disclosed in whole or in part without prior written permission of SHANGHAI AVIC OPTOELECTRONICS Corporation.



Note 1: Definition of optical measurement system.

The optical characteristics should be measured in dark room. After 5 Minutes operation, the optical properties are measured at the center point of the LCD screen. All input terminals LCD panel must be ground when measuring the center area of the panel.

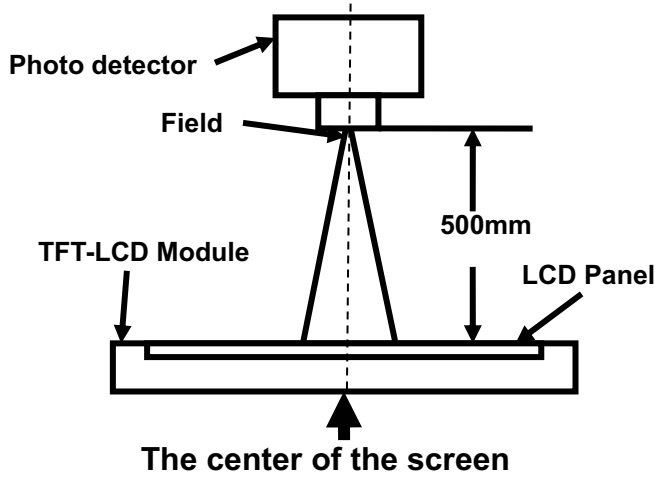

Item	Photo detector	Field
Contrast Ratio	SR-3A	1°
Luminance		
Chromaticity		
Lum Uniformity		
Response Time	BM-7A	2°

Note 2: Definition of viewing angle range and measurement system.

viewing angle is measured at the center point of the LCD by CONOSCOPE(ergo-80).

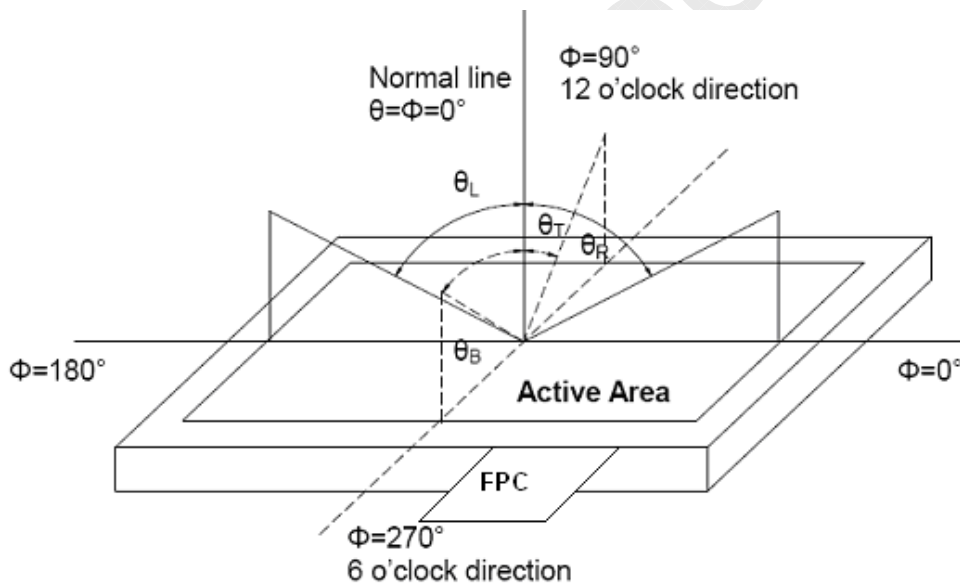

Note 3: Definition of contrast ratio

$$\text{Contrast ratio (CR)} = \frac{\text{Luminance measured when LCD is on the "White" state}}{\text{Luminance measured when LCD is on the "Black" state}}$$

"White state": The state is that the LCD should drive by V_{white} .

"Black state": The state is that the LCD should drive by V_{black} .

V_{white} : To be determined V_{black} : To be determined.

Note 4: Definition of Response time

The information contained herein is the exclusive property of SHANGHAI AVIC OPTOELECTRONICS Corporation, and shall not be distributed, reproduced, or disclosed in whole or in part without prior written permission of SHANGHAI AVIC OPTOELECTRONICS Corporation.



The response time is defined as the LCD optical switching time interval between "White" state and "Black" state. Rise time (T_{ON}) is the time between photo detector output intensity changed from 90% to 10%. And fall time (T_{OFF}) is the time between photo detector output intensity changed from 10% to 90%.

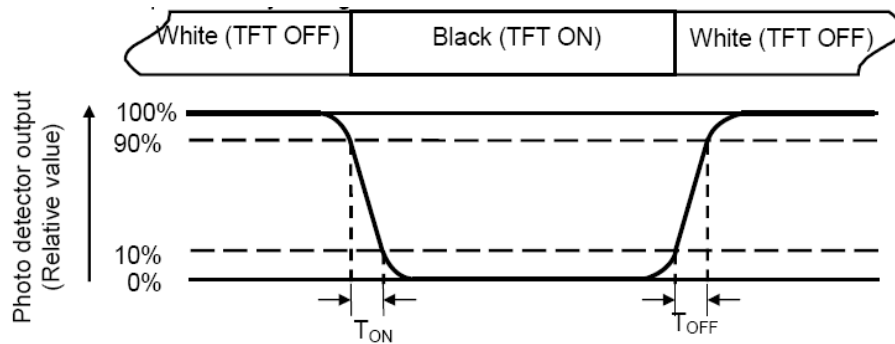

Note 5: Definition of color chromaticity (CIE1931)

Color coordinates measured at center point of LCD.

Note 6: Definition of Luminance Uniformity

Active area is divided into 9 measuring areas (Refer Fig. 2). Every measuring point is placed at the center of each measuring area.

$$\text{Luminance Uniformity (U)} = L_{\min} / L_{\max}$$

L-----Active area length W----- Active area width

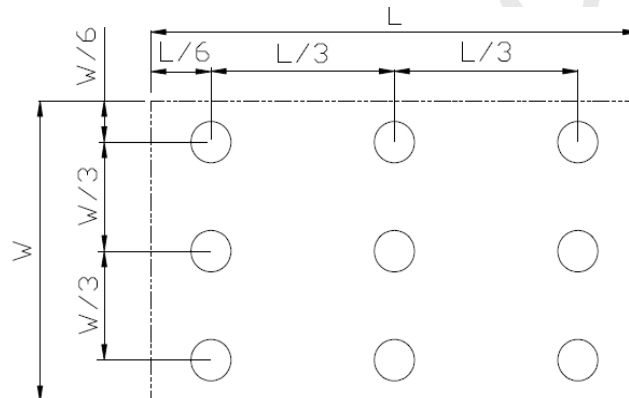

L_{\max} : The measured Maximum luminance of all measurement position.

L_{\min} : The measured Minimum luminance of all measurement position.

Note 7: Definition of Luminance:

Measure the luminance of white state at center point.



7 Environmental / Reliability Test

No	Test Item	Condition	Remarks
1	High Temperature Operation	Ts = +70°C, 240 hours	IEC60068-2-1 GB2423.2
2	Low Temperature Operation	Ta = -20°C, 240 hours	IEC60068-2-1 GB2423.1
3	High Temperature Storage	Ta = +80°C, 240 hours	IEC60068-2-1 GB2423.2
4	Low Temperature Storage	Ta = -30°C, 240 hours	IEC60068-2-1 GB2423.1
5	Storage at High Temperature and Humidity	Ta = +60°C, 90% RH max,240hours	IEC60068-2-78 GB/T2423.3
6	Thermal Shock (non-operation)	-30°C 30 min~+80°C 30 min, Change time:5min, 100 Cycle	Start with cold temperature, End with high temperature, IEC60068-2-14,GB2423.22
7	ESD	C=150pF,R=330Ω,5point/panel Air:±8Kv,5times; Contact:±4Kv,5times (Environment:15°C~35°C, 30%~60%.86Kpa~106Kpa)	IEC61000-4-2 GB/T17626.2
8	Vibration Test	Frequency range:10~55Hz Stroke:1.5mm Sweep:10Hz~55Hz~10Hz 2 hours for each direction of X.Y.Z. (6 hours for total)	IEC60068-2-6 GB/T2423.10
9	Mechanical Shock (Non Op)	Half Sine Wave 100G 6ms, ±X,±Y,±Z 3times for each direction	IEC60068-2-27 GB/T2423.5
10	Package Drop Test	Height:60cm, 1corner,3edges,6surfaces	IEC60068-2-32 GB/T2423.8

Note1: Ts is the temperature of panel's surface.

Note2: Ta is the ambient temperature of samples.

The information contained herein is the exclusive property of SHANGHAI AVIC OPTOELECTRONICS Corporation, and shall not be distributed, reproduced, or disclosed in whole or in part without prior written permission of SHANGHAI AVIC OPTOELECTRONICS Corporation.



SHANGHAI TIANMA MICRO-ELECTRONICS

TM084SDHG01 V1.0

8 Mechanical Drawing

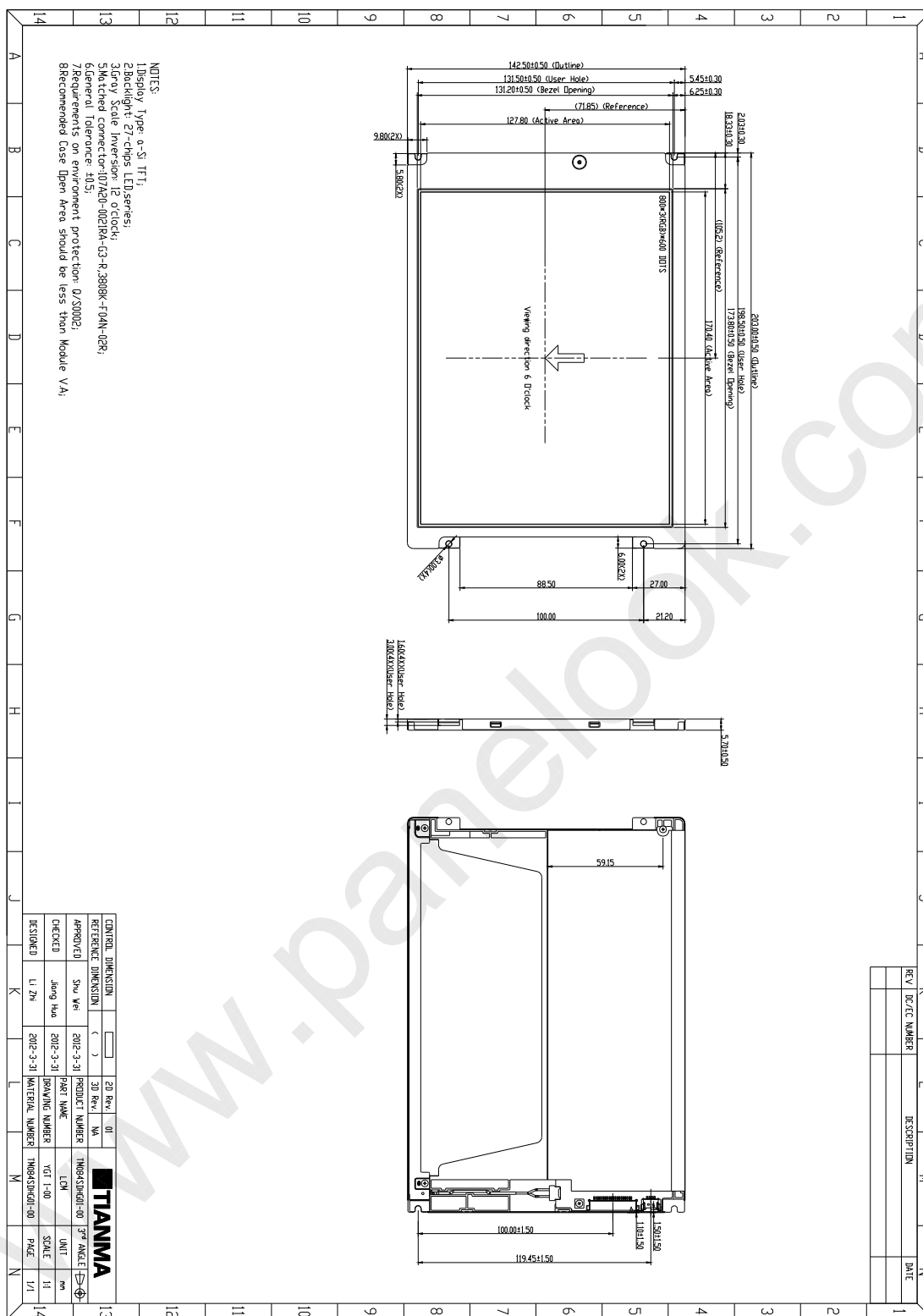

The information contained herein is the exclusive property of SHANGHAI AVIC OPTOELECTRONICS Corporation, and shall not be distributed, reproduced, or disclosed in whole or in part without prior written permission of SHANGHAI AVIC OPTOELECTRONICS Corporation.



SHANGHAI TIANMA MICRO-ELECTRONICS

TM084SDHG01 V1.0

9 Packing drawing

No	Item	Model (Material)	Dimensions(mm)	Unit Weight(Kg)	Quantity	Remark
1	LCM module	TM084SDHG01-00	203X142.5X5.7	TBD	36	
2	Partition_1	Corrugated paper	527X348X217	1.571	1	
3	Anti-static Bag	PE	161X253X0.05	0.001	36	Anti-static
4	Dust-Proof Bag	PE	700X545	0.06	1	
5	Partition_2	Corrugated Paper	505X332X4.0	0.92	2	
6	Corrugated Bar	Corrugated paper	348X173	0.057	4	
7	Carton	Corrugated paper	544X365X250	0.76	1	
9	Total weight	TBD Kg±10%				

The information contained herein is the exclusive property of SHANGHAI AVIC OPTOELECTRONICS Corporation, and shall not be distributed, reproduced, or disclosed in whole or in part without prior written permission of SHANGHAI AVIC OPTOELECTRONICS Corporation.



10 Precautions for Use of LCD Modules

10.1 Handling Precautions

10.1.1 The display panel is made of glass. Do not subject it to a mechanical shock by dropping it from a high place, etc.

10.1.2 If the display panel is damaged and the liquid crystal substance inside it leaks out, be sure not to get any in your mouth, if the substance comes into contact with your skin or clothes, promptly wash it off using soap and water.

10.1.3 Do not apply excessive force to the display surface or the adjoining areas since this may cause the color tone to vary.

10.1.4 The polarizer covering the display surface of the LCD module is soft and easily scratched. Handle this polarizer carefully.

10.1.5 If the display surface is contaminated, breathe on the surface and gently wipe it with a soft dry cloth. If still not completely clear, moisten cloth with one of the following solvents:

- Isopropyl alcohol
- Ethyl alcohol

Solvents other than those mentioned above may damage the polarizer. Especially, do not use the following:

- Water
- Ketone
- Aromatic solvents

10.1.6 Do not attempt to disassemble the LCD Module.

10.1.7 If the logic circuit power is off, do not apply the input signals.

10.1.8 To prevent destruction of the elements by static electricity, be careful to maintain an optimum work environment.

10.1.8.1 Be sure to ground the body when handling the LCD Modules.

10.1.8.2 Tools required for assembly, such as soldering irons, must be properly ground.

10.1.8.3 To reduce the amount of static electricity generated, do not conduct assembly and other work under dry conditions.

10.1.8.4 The LCD Module is coated with a film to protect the display surface. Be care when peeling off this protective film since static electricity may be generated.

10.2 Storage precautions

10.2.1 When storing the LCD modules, avoid exposure to direct sunlight or to the light of fluorescent lamps.

10.2.2 The LCD modules should be stored under the storage temperature range. If the LCD modules will be stored for a long time, the recommend condition is:

Temperature : 0°C ~ 40°C Relatively humidity: ≤80%

10.2.3 The LCD modules should be stored in the room without acid, alkali and harmful gas.

10.3 Transportation Precautions

10.3.1 The LCD modules should be no falling and violent shocking during transportation, and also should avoid excessive press, water, damp and sunshine.

The information contained herein is the exclusive property of SHANGHAI AVIC OPTOELECTRONICS Corporation, and shall not be distributed, reproduced, or disclosed in whole or in part without prior written permission of SHANGHAI AVIC OPTOELECTRONICS Corporation.