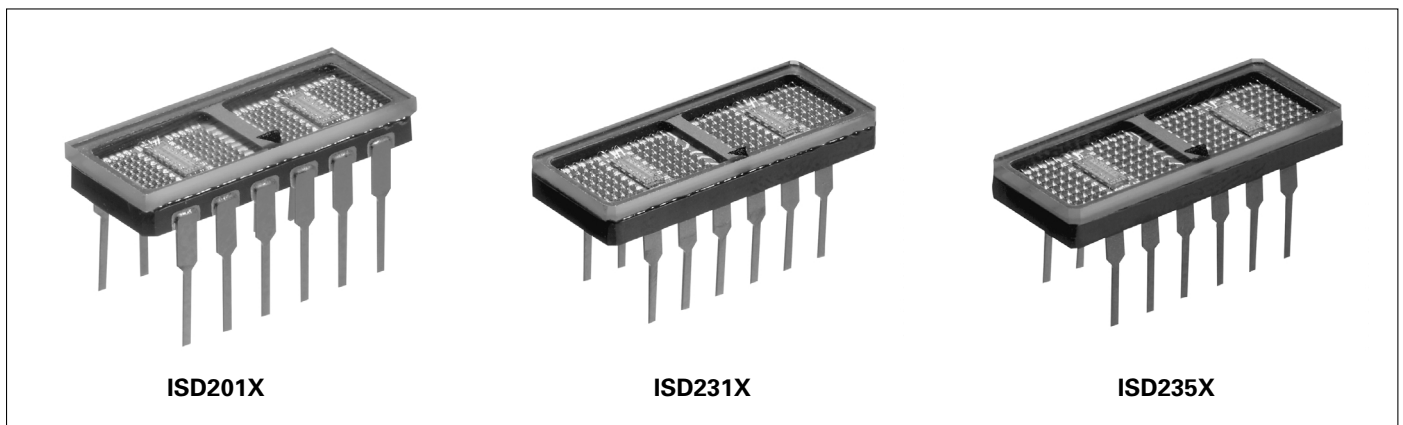


**RED ISD2010/2310**  
**YELLOW ISD2011/2311/2351**  
**HIGH EFFICIENCY RED ISD2012/2312/2352**  
**HIGH EFFICIENCY GREEN ISD2013/2313/2353**  
**4-Character 5 x 7 Dot Matrix**  
**Serial Input Alphanumeric Industrial Display**  
**Sunlight Viewable: ISD235X**



## FEATURES

- **Four Dot Matrix Characters**
- **Character Height**  
**ISD201X—0.150"**  
**ISD231X/235X—0.200"**
- **ISD201X/231X, Four Colors: Red, Yellow, High Efficiency Red, High Efficiency Green**
- **ISD235X, Three Colors: Yellow, High Efficiency Red, High Efficiency Green**
- **Wide Viewing Angle**
- **Built-in CMOS Shift Registers with Constant Current LED Row Drivers**
- **Shift Registers Allow Custom Fonts**
- **Easily Cascaded for Multiple Displays**
- **TTL Compatible**
- **End Stackable**
- **Operating Temperature Range:**  
**–55°C to +100°C**
- **Categorized for Luminous Intensity**
- **Ceramic Package, Hermetically Sealed Flat Glass Window**

## DESCRIPTION

The ISD201X/231X/235X are four digit 5 x 7 dot matrix serial input alphanumeric displays. The displays are available in red, yellow, high efficiency red, or high efficiency green. The package is a standard twelve-pin hermetic DIP with glass lens. The display can be stacked horizontally or vertically to form messages of any length.

These displays have two fourteen-bit CMOS shift registers with built-in row drivers. These shift registers drive twenty-eight rows and enable the design of customized fonts. Cascading multiple displays is possible because of the Data In and Data Out pins. Data In and Out are easily input with the clock signal and displayed in parallel on the row drivers. Data Out represents the output of the 7th bit of digit number four shift register. The shift register is level triggered. The like columns of each character in a display cluster are tied to a single pin (see Block Diagram). High true data in the shift register enables the output current mirror driver stage associated with each row of LEDs in the 5 x 7 diode array.

The TTL compatible  $V_B$  input may either be tied to  $V_{CC}$  for maximum display intensity or pulse width modulated to achieve intensity control and reduce power consumption.

**DESCRIPTION (continued)**

In the normal mode of operation, input data for digit four, column one is loaded into the seven on-board shift register locations one through seven. Column one data for digits 3, 2, and 1 is shifted into the display shift register locations. Then column one input is enabled for an appropriate period of time, T. A similar process is repeated for columns 2, 3, 4, and 5. If the decode time and load data time into the shift register is t, then with five columns, each column of the display is operating at a duty factor of:

$$DF = \frac{T}{5(T + t)}$$

T+t, allotted to each display column, is generally chosen to provide the maximum duty factor consistent with the minimum refresh rate necessary to achieve a flicker free display. For most strobed display systems, each column of the display should be refreshed (turned on) at a minimum rate of 100 times per second.

With columns to be addressed, this refresh rate then gives a value for the time T+t of: 1/[5 x (100)]=2.0 msec. If the device is operated at 5.0 MHz clock rate maximum, it is possible to maintain t<T. For short display strings, the duty factor will then approach 20%.

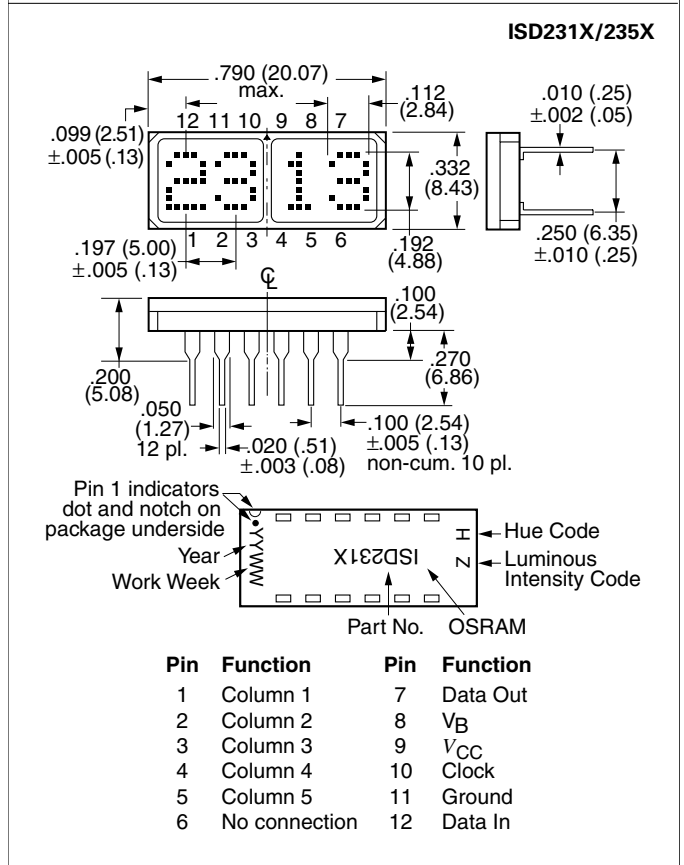
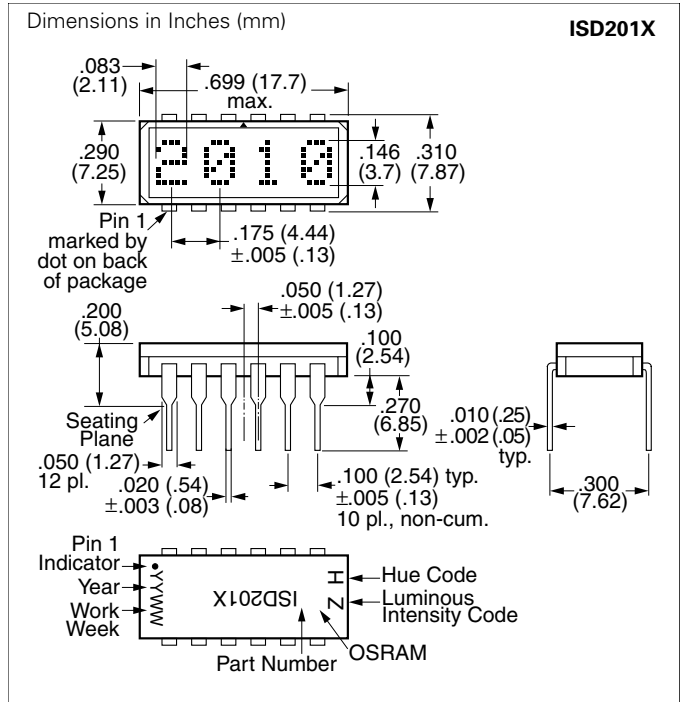
See Appnote 44 for application information and Appnotes 18, 19, 22, 23 at [www.infineon.com/opto](http://www.infineon.com/opto).

**Maximum Ratings**

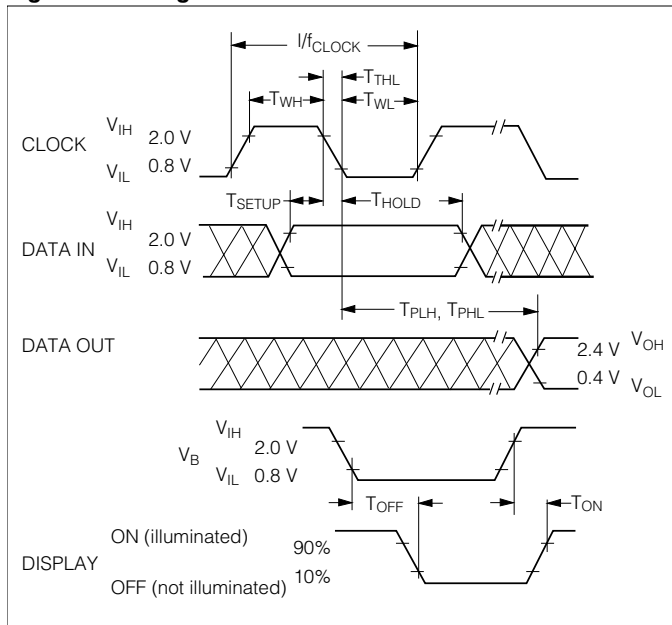
Supply Voltage V <sub>CC</sub> to GND .....	-0.5 V to +7.0 V
Inputs, Data Out and V <sub>B</sub> .....	-0.5 V to V <sub>CC</sub> +0.5 V
Column Input Voltage, V <sub>COL</sub> .....	-0.5 V to +6.0 V
Operating Temperature Range .....	-55°C to +100°C
Storage Temperature Range .....	-65°C to +125°C
Maximum Solder Temperature, 0.063" (1.59 mm) below Seating Plane, t<5.0 s .....	260°C
Maximum Allowable Power Dissipation, T <sub>A</sub> =25°C <sup>(2)</sup>	
ISD2010 .....	0.91 W
ISD2011/2/3 .....	0.86 W
ISD231X .....	1.1 W
ISD235X .....	1.35 W

**Notes:**

- 1) Operation above +100°C ambient is possible if the following conditions are met. The junction should not exceed T<sub>J</sub>=125°C and the case temperature (as measured at pin 1 or the back of the display) should not exceed TC=100°C.
- 2) Maximum allowable dissipation is derived from V<sub>CC</sub>=5.25 V, V<sub>B</sub>=2.4 V, V<sub>COL</sub>=3.5 V 20 LEDs on per character, 20% DF.



**Figure 1. Timing Characteristics**



**AC Electrical Characteristics**

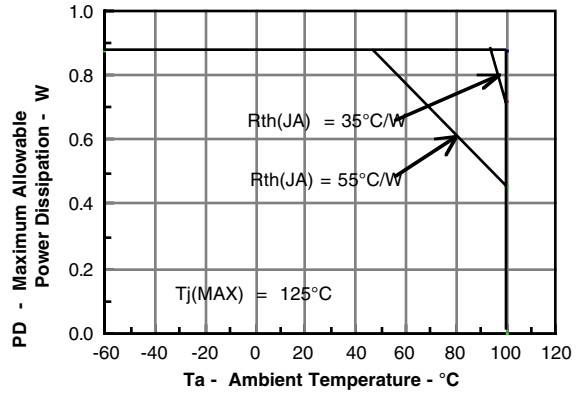
( $V_{CC}=4.75$  to  $5.25\text{ V}$ ,  $T_A=-55^\circ\text{C}$  to  $100^\circ\text{C}$ )

Symbol	Description	Min.	Typ.	Max. (1)	Units	Fig.
$T_{\text{SETUP}}$	Setup Time	50	10	—	ns	1
$T_{\text{HOLD}}$	Hold Time	25	20	—	ns	1
$T_{\text{WL}}$	Clock Width Low	75	45	—	ns	1
$T_{\text{WH}}$	Clock Width High	75	45	—	ns	1
$F_{(\text{CLK})}$	Clock Frequency	—	—	5	MHz	1
$T_{\text{THL}}$ $T_{\text{TLH}}$	Clock Transition Time	—	75	200	ns	1
$T_{\text{PHL}}$ $T_{\text{PLH}}$	Propagation Delay Clock to Data Out	—	50	125	ns	1

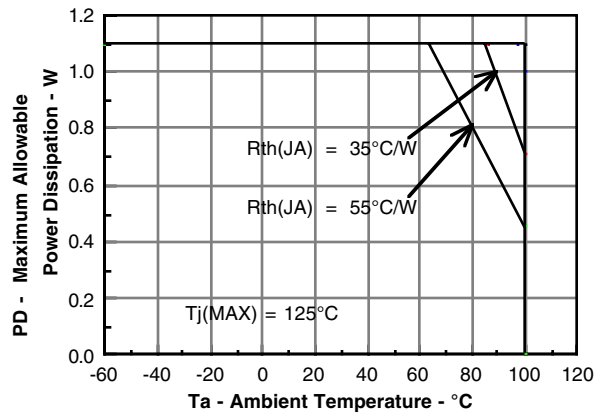
**Notes:**

- 1) All typical values specified at  $V_{CC}=5.0\text{ V}$  and  $T_A=25^\circ\text{C}$  unless otherwise noted.
- 2)  $V_B$  Pulse Width Frequency—50 kHz (max.)

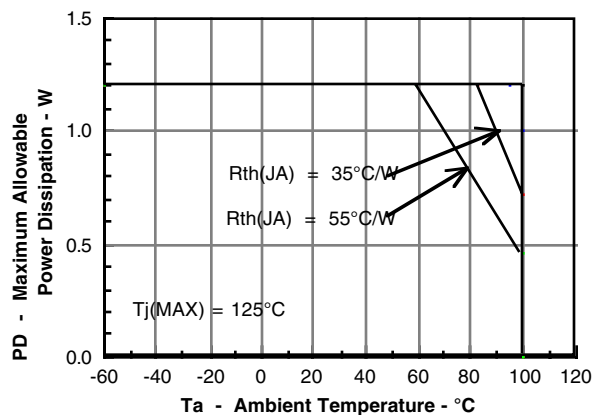
**Figure 2. Maximum Allowable Power Dissipation vs. Temperature, ISD201X**



**Figure 3. Maximum Allowable Power Dissipation vs. Temperature, ISD231X**



**Figure 4. Maximum Allowable Power Dissipation vs. Temperature, ISD235X**



## Optical Characteristics

### Red ISD2010, ISD2310

Description		Symbol	Min.	Typ. <sup>(4)</sup>	Units	Test Conditions
Peak Luminous Intensity per LED <sup>(1,3)</sup> (Character Average)	ISD2010	$I_{Vpeak}$	105	200	$\mu\text{cd}$	$V_{CC}=5.0\text{ V}$ , $V_{COL}=3.5\text{ V}$ $T_J=25^\circ\text{C}^{(5)}$ , $V_B=2.4\text{ V}$
	ISD2310		220	370		
Peak Wavelength		$\lambda_{Vpeak}$	—	660	nm	—
Dominant Wavelength <sup>(2)</sup>		$\lambda_{dom}$	—	639	nm	—

### Yellow ISD2011, ISD2311, ISD2351

Description		Symbol	Min.	Typ. <sup>(4)</sup>	Units	Test Conditions
Peak Luminous Intensity per LED <sup>(1,3)</sup> (Character Average)	ISD2011	$I_{Vpeak}$	400	750	$\mu\text{cd}$	$V_{CC}=5.0\text{ V}$ , $V_{COL}=3.5\text{ V}$ $T_J=25^\circ\text{C}^{(5)}$ , $V_B=2.4\text{ V}$
	ISD2311		650	1140		
	ISD2351		2400	3400		
Peak Wavelength		$\lambda_{Vpeak}$	—	583	nm	—
Dominant Wavelength <sup>(2)</sup>		$\lambda_{dom}$	—	585	nm	—

### High Efficiency Red ISD2012, ISD2312, ISD2352

Description		Symbol	Min.	Typ. <sup>(4)</sup>	Units	Test Conditions
Peak Luminous Intensity per LED <sup>(1,3)</sup> (Character Average)	ISD2012	$I_{Vpeak}$	400	1430	$\mu\text{cd}$	$V_{CC}=5.0\text{ V}$ , $V_{COL}=3.5\text{ V}$ $T_J=25^\circ\text{C}^{(5)}$ , $V_B=2.4\text{ V}$
	ISD2312		650	1430		
	ISD2352		853	2500		
Peak Wavelength		$\lambda_{Vpeak}$	—	630	nm	—
Dominant Wavelength <sup>(2)</sup>		$\lambda_{dom}$	—	626	nm	—

### High Efficiency Green ISD2013, ISD2313, ISD2353

Description		Symbol	Min.	Typ. <sup>(4)</sup>	Units	Test Conditions
Peak Luminous Intensity per LED <sup>(1,3)</sup> (Character Average)	ISD2013	$I_{Vpeak}$	850	1550	$\mu\text{cd}$	$V_{CC}=5.0\text{ V}$ , $V_{COL}=3.5\text{ V}$ $T_J=25^\circ\text{C}^{(5)}$ , $V_B=2.4\text{ V}$
	ISD2313		1280	2410		
	ISD2353		2400	3000		
Peak Wavelength		$\lambda_{Vpeak}$	—	568	nm	—
Dominant Wavelength <sup>(2)</sup>		$\lambda_{dom}$	—	574	nm	—

#### Notes:

- 1) The displays are categorized for luminous intensity with the intensity category designated by a letter code on the bottom of the package.
- 2) Dominant wavelength ( $\lambda_{dom}$ ) is derived from the CIE chromaticity diagram and represents the single wavelength which defines the color of the device.
- 3) The luminous sterance of the LED may be calculated using the following relationships:  

$$L_V (\text{cd/m}^2) = I_V (\text{Candela})/A (\text{Meter})^2$$

$$L_V (\text{Footlamberts}) = \pi I_V (\text{Candela})/A (\text{Foot})^2$$

$$A = 5.3 \times 10^{-8} \text{ m}^2 = 5.8 \times 10^{-7} (\text{Foot})^2$$
- 4) All typical values specified at  $V_{CC}=5.0\text{ V}$  and  $T_A=25^\circ\text{C}$  unless otherwise noted.
- 5) The luminous intensity is measured at  $T_A=T_J=25^\circ\text{C}$ . No time is allowed for the device to warm up prior to measurement.

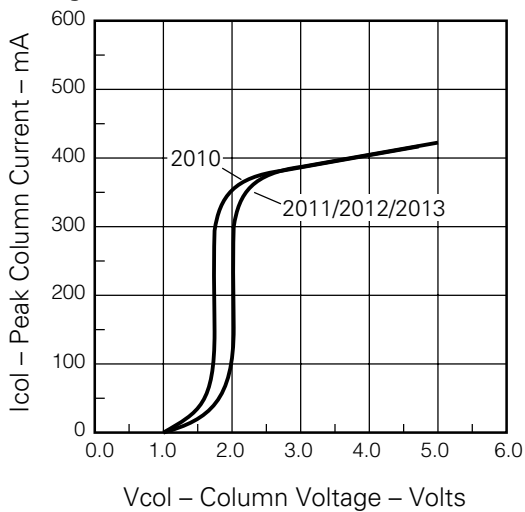
**Recommended Operating Conditions**  
(Guaranteed over operating temperature range)

Parameter	Symbol	Min.	Nom.	Max.	Units
Supply Voltage	$V_{CC}$	4.75	5.0	5.25	V
Data Out Current, Low State	$I_{OL}$	—	—	—	mA
Data Out Current, High State	$I_{OH}$	—	—	—	mA
Column Input Voltage, Column On <sup>(1)</sup>	$V_{COL}$	2.75	—	3.5	V
Setup Time	$T_{SETUP}$	70	45	—	ns
Hold Time	$T_{HOLD}$	30	—	—	ns
Width of Clock	$T_{W(CLK)}$	75	—	—	ns
Clock Frequency	$T_{CLK}$	—	—	5.0	MHz
Clock Transition Time	$T_{THL}$	—	—	200	ns
Free Air Operating Temperature Range	$T_A$	-55	—	+100	°C

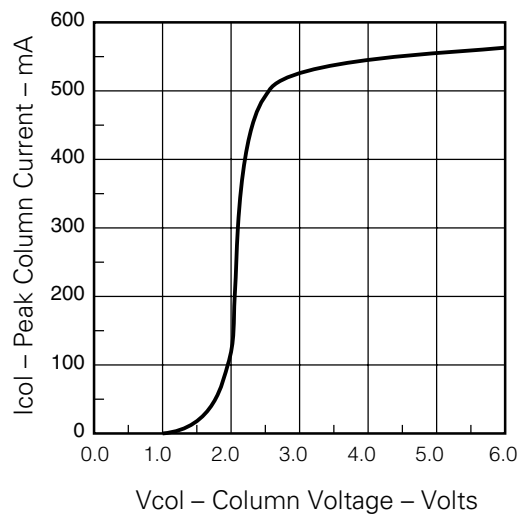
Note:

1) See Figures 5, 6 and 7: Peak column current versus column voltage

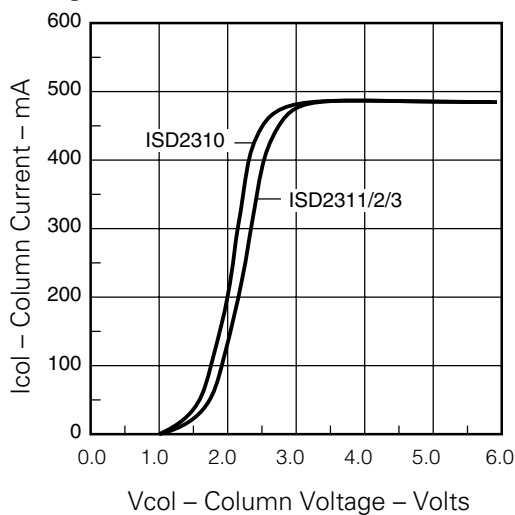
**Figure 5. Peak Column Current vs. Column Voltage, ISD201X**



**Figure 7. Peak Column Current vs. Column Voltage, ISD235X**



**Figure 6. Peak Column Current vs. Column Voltage, ISD231X**



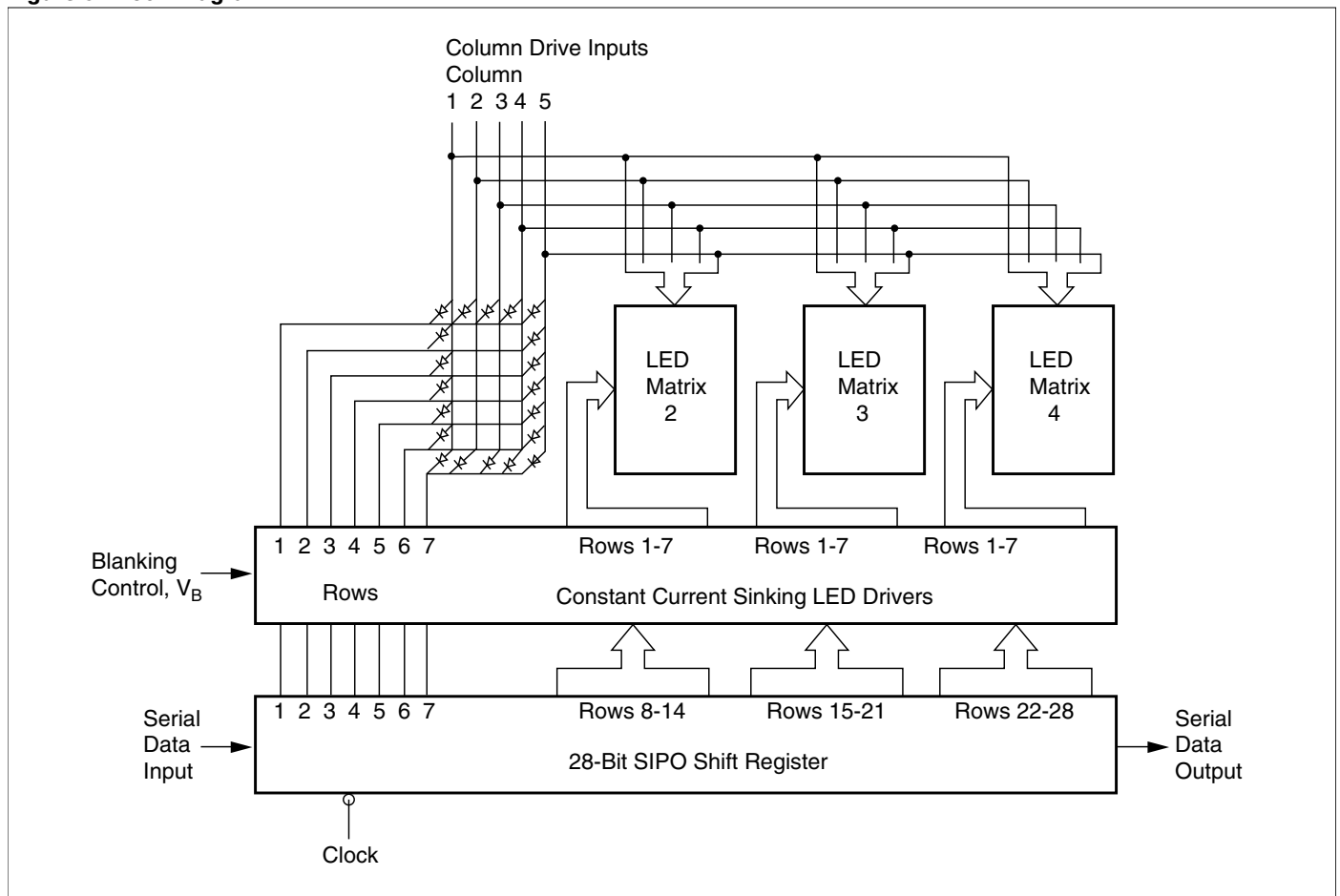
**Electrical Characteristics** (–55°C to +100°C, unless otherwise specified)

Description	Symbol	Min.	Typ. <sup>(1)</sup>	Max.	Units	Test Conditions	
Supply Current (quiescent)	$I_{CC}$	—	—	5.0	mA	$V_B=0.4\text{ V}$	$V_{CC}=5.25\text{ V}$ $V_{CLK}=V_{DATA}=2.4\text{ V}$ All SR Stages=Logical 1
		—	—	5.0		$V_B=2.4\text{ V}$	
Supply Current (operating)	$I_{CC}$	—	—	10	mA	$F_{CLK}=5.0\text{ MHz}$	
Column Current at Any Column Input <sup>(2)</sup>	$I_{COL}$	—	—	10	$\mu\text{A}$	$V_B=0.4\text{ V}$	$V_{CC}=5.25\text{ V}$ $V_{COL}=3.5\text{ V}$ All SR Stages=Logical 1
Column Current at Any Column Input <sup>(2)</sup> ISD2010 red ISD2011/2/3: yellow, HER, green ISD231X: red, yellow, HER, green ISD235X: yellow, HER, green	$I_{COL}$	—	350 335 380 550	435 410 520 650	mA	—	
$V_B$ , Clock or Data Input Threshold Low	$V_{IL}$	—	—	0.8	V	$V_{CC}=4.75\text{ V}–5.25\text{ V}$	
$V_B$ , Clock or Data Input Threshold High	$V_{IH}$	2.0	—	—	V		
Data Out Voltage	$V_{OH}$	2.4	3.6	—	V	$I_{OH}=0.5\text{ mA}$	$V_{CC}=5.25\text{ V}$ $I_{COL}=0\text{ mA}$
	$V_{OL}$	—	—	—	—	$I_{OL}=1.6\text{ mA}$	
Input Current Logical 0, $V_B$ only	$I_{IL}$	–30	–110	–300	$\mu\text{A}$	$V_{CC}=4.75\text{ V}–5.25\text{ V}$ , $V_{IL}=0.8\text{ V}$	
Input Current Logical 0, Data, Clock	$I_{IL}$	—	—	—	—		
Power Dissipation per Package ISD201X ISD231X ISD235X	$P_D$	0.44 0.52 0.74	—	—	W	$V_{CC}=5.0\text{ V}$ , $V_{COL}=3.5\text{ V}$ , 17.5% DF 15 LEDs on per character, $V_B=2.4\text{ V}$	
Thermal Resistance IC, Junction-to-Pin ISD201X ISD231X ISD235X	$R_{\theta J-PIN}$	—	30 20 25	—	°C/W/ Device	—	

**Notes:**

- 1) All typical values specified at  $V_{CC}=5.0\text{ V}$  and  $T_A=25^\circ\text{C}$  unless otherwise noted.
- 2) See Figures 5, 6 and 7: Peak column current versus column voltage

**Figure 8. Block Diagram**



**Contrast Enhancement Filters for Sunlight Readability**

Display Color	Filter Color	Marks Polarized Corp.*	Optical Characteristics of Filter
Red, HER	Red	MPC 20-15C	25% at 635 nm, Circular Polarizer
Yellow	Amber	MPC 30-25C	25% at 583 nm, Circular Polarizer
Green	Yellow/Green	MPC 50-122C	22% at 568 nm, Circular Polarizer
Multiple Colors High Ambient Light	Neutral Gray	MPC 80-10C	10% Neutral, Circular Polarizer
Multiple Colors	Neutral Gray	MPC 80-37C	37% Neutral, Circular Polarizer

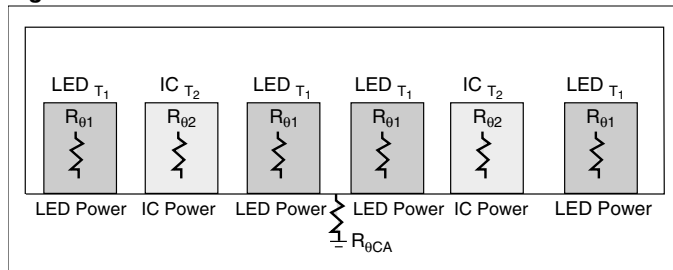
\* Marks Polarized Corp.  
 25-B Jefryn Blvd. W.  
 Deer Park, NY 11729  
 516/242-1300  
 FAX 516/242-1347  
 Marks Polarized Corp. manufactures  
 to MIL-1-45208 inspection system.

The small alphanumeric displays are hybrid LED and CMOS assemblies that are designed for reliable operation in commercial and industrial environments. Optimum reliability and optical performance will result when the junction temperature of the LEDs and CMOS ICs are kept as low as possible.

### Thermal Modeling

ISD displays consist of two driver ICs and four 5 x 7 LED matrixes. A thermal model of the display is shown in Figure 9. It illustrates that the junction temperature of the semiconductor = junction self heating + the case temperature rise + the ambient temperature. Equation 1 shows this relationship.

**Figure 9. Thermal Model**



See Equation 1 below.

The junction rise within the LED is the product of the thermal impedance of an individual LED (37°C/W, DF=20%, F=200 Hz), times the forward voltage,  $V_{F(LED)}$ , and forward current  $I_F(LED)$ , of 13 – 14.5 mA. This rise averages  $T_{J(LED)}=1^\circ\text{C}$ . The Table below shows the  $V_{F(LED)}$  for the respective displays.

Model Number	VF		
	Min.	Typ.	Max.
ISD2010 ISD2310	1.6	1.7	2.0
ISD2011/2/3 ISD2311/2/3 ISD2351/2/3	1.9	2.2	3.0

The junction rise within the LED driver IC is the combination of the power dissipated by the IC quiescent current and the 28 row driver current sinks. The IC junction rise is given in Equation 2.

A thermal resistance of 28°C/W results in a typical junction rise of 6°C.

See Equation 2 below.

### Equation 1.

$$T_{J(LED)} = P_{LED} Z_{\theta JC} + P_{CASE} (R_{\theta JC} + R_{\theta CA}) + T_A$$

$$T_{J(LED)} = [(I_{COL}/28)V_{F(LED)} Z_{\theta JC}] + [(n/35)I_{COL} DF (5V_{COL}) + V_{CC} I_{CC}] \cdot [R_{\theta JC} + R_{\theta CA}] + T_A$$

### Equation 2.

$$T_{J(IC)} = P_{COL} (R_{\theta JC} + R_{\theta CA}) + T_A$$

$$T_{J(IC)} = [5(V_{COL} - V_{F(LED)}) \cdot (I_{COL}/2) \cdot (n/35) DF + V_{CC} \cdot I_{CC}] \cdot [R_{\theta JC} + R_{\theta CA}] + T_A$$

For ease of calculations the maximum allowable electrical operating condition is dependent upon the aggregate thermal resistance of the LED matrixes and the two driver ICs. All of the thermal management calculations are based upon the parallel combination of these two networks which is 15°C/W. Maximum allowable power dissipation is given in Equation 3.

### Equation 3.

$$P_{DISPLAY} = \frac{T_{J(MAX)} - T_A}{R_{\theta JC} + R_{\theta CA}}$$

$$P_{DISPLAY} = 5V_{COL} I_{COL} (n/35) DF + V_{CC} I_{CC}$$

For further reference see Figures 2, 3, 4 and 11 – 23.

### Key to equation symbols

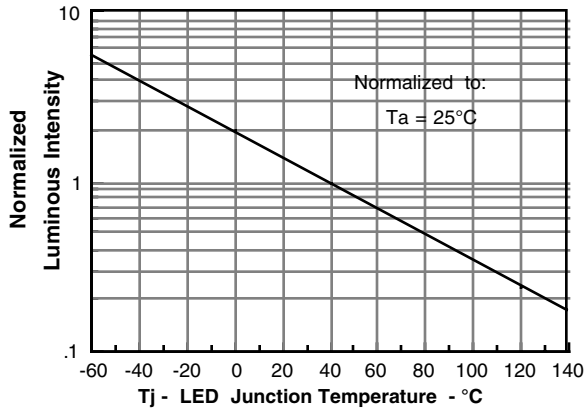
DF	Duty factor
$I_{CC}$	Quiescent IC current
$I_{COL}$	Column current
n	Number of LEDs on in a 5 x 7 array
$P_{CASE}$	Package power dissipation excluding LED under consideration
$P_{COL}$	Power dissipation of a column
$P_{DISPLAY}$	Power dissipation of the display
$P_{LED}$	Power dissipation of a LED
$R_{\theta CA}$	Thermal resistance case to ambient
$R_{\theta JC}$	Thermal resistance junction to case
$T_A$	Ambient temperature
$T_{J(IC)}$	Junction temperature of an IC
$T_{J(LED)}$	Junction temperature of a LED
$T_{J(MAX)}$	Maximum junction temperature
$V_{CC}$	IC voltage
$V_{COL}$	Column voltage
$V_{F(LED)}$	Forward voltage of LED
$Z_{\theta JC}$	Thermal impedance junction to case

### Optical Considerations

The light output of the LEDs is inversely related to the LED diode's junction temperature as shown in Figure 10. For optimum light output, keep the thermal resistance of the socket or PC board as low as possible.

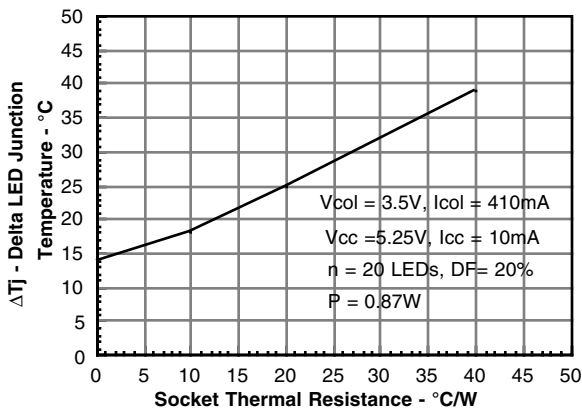


**Figure 10. Normalized Luminous Intensity vs. Junction Temperature**

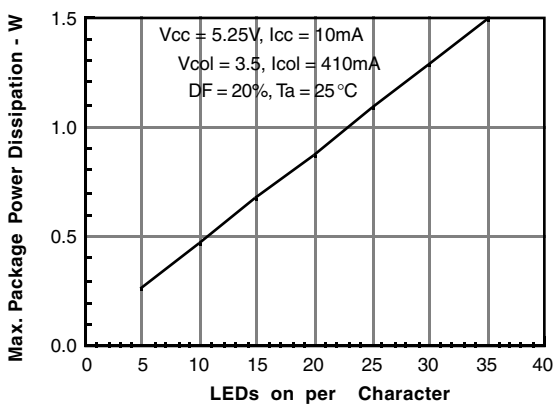


When mounted in a 10°C/W socket and operated at Absolute Maximum Electrical conditions, the display will show an LED junction rise of 17°C. If T<sub>A</sub>=40°C, then the LED's T<sub>J</sub> will be 57°C. Under these conditions Figure 11 shows that the IV will be 75% of its 25°C value.

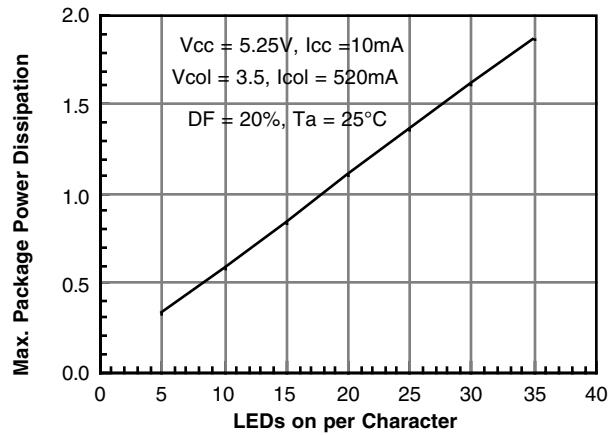
**Figure 11. Max. LED Junction Temperature vs. Socket Thermal Resistance**



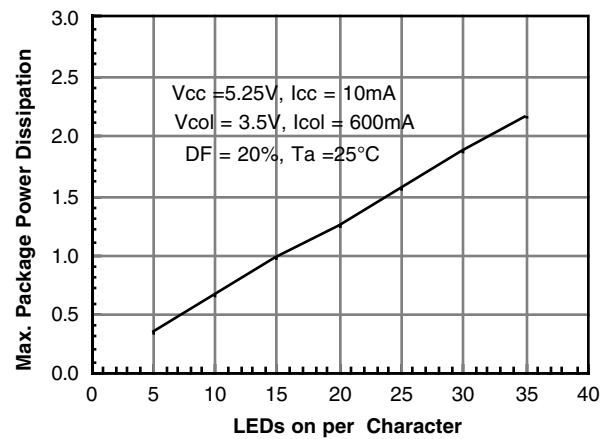
**Figure 12. Max. Package Power Dissipation, ISD201X**



**Figure 13. Max. Package Power Dissipation, ISD231X**



**Figure 14. Max. Package Power Dissipation, ISD235X**



**Figure 15. Package Power Dissipation, ISD201X**

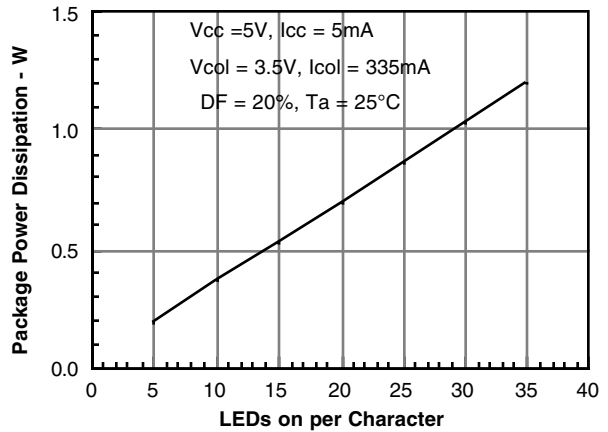


Figure 16. Max. Package Power Dissipation, ISD231X

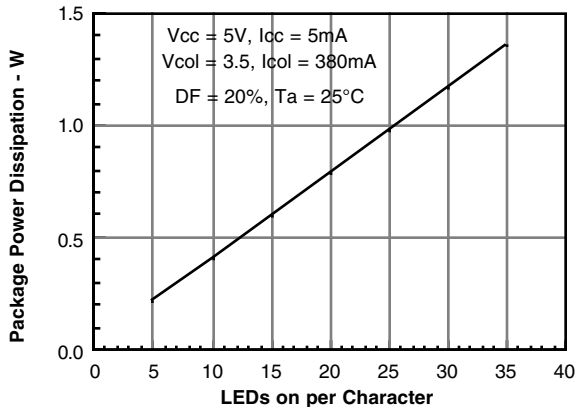


Figure 20. Max. Character Power Dissipation, ISD235X

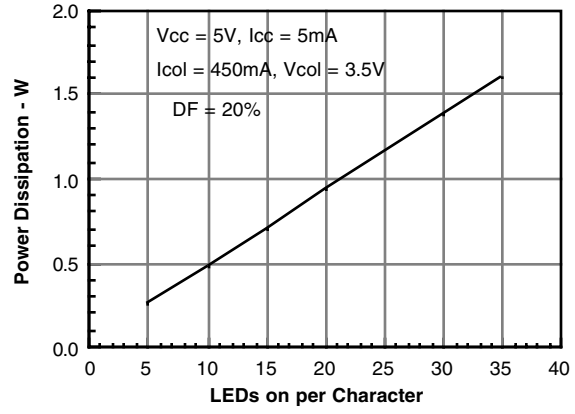


Figure 17. Max. Package Power Dissipation, ISD235X

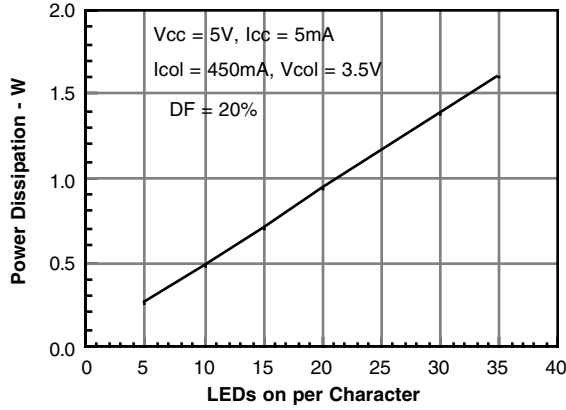


Figure 21. Character Power Dissipation, ISD201X

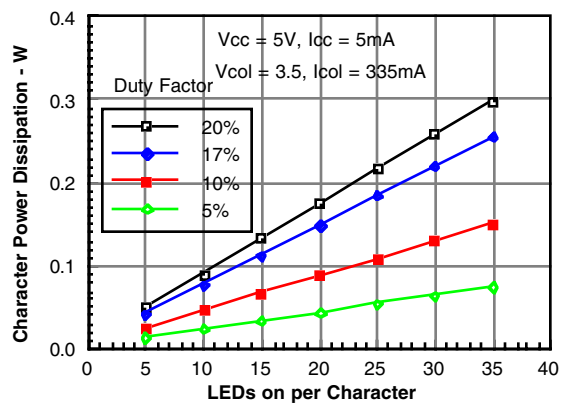


Figure 18. Max. Character Power Dissipation, ISD201X

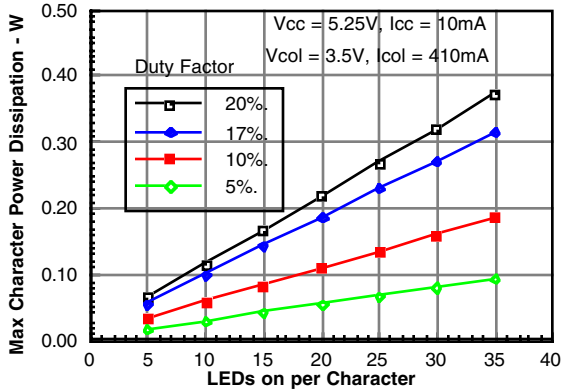


Figure 22. Character Power Dissipation, ISD231X

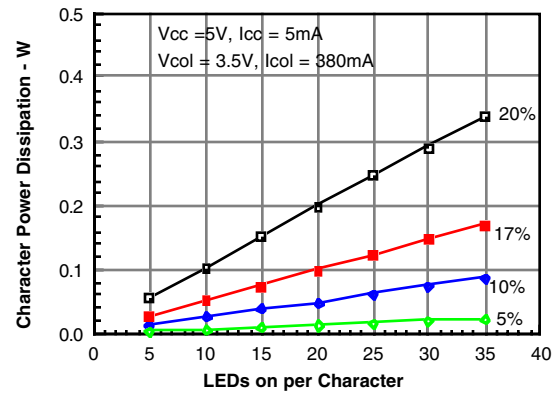


Figure 19. Max. Character Power Dissipation, ISD231X

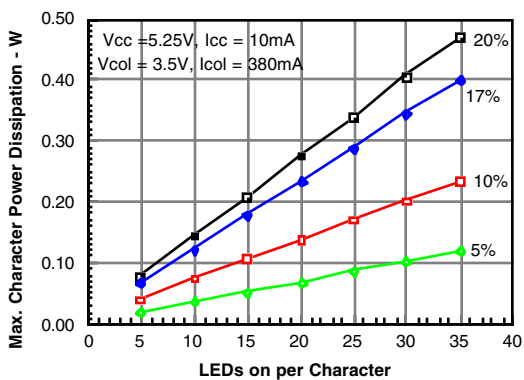


Figure 23. Character Power Dissipation, ISD235X

