

Keysight Technologies

N9398C/F/G and N9399C/F DC Block

Technical Overview





Introduction

Key Features

- Maximize your operating range - 26.5, 50 or 67 GHz
- Improve calibration accuracy with exceptional return loss >15 dB at 67 GHz
- Maximum available power with < 0.9 dB insertion loss
- 2 choices of DC voltage ratings for a wide range of applications

Description

The Keysight Technologies, Inc. N9398C/F/G and N9399C/F DC blocks offer a new level of DC blocking with broadband performance specified from 50 kHz right up to 67 GHz. Designed to apply AC drive signals to a device while eliminating any DC voltage or current components, these DC blocks feature a broad frequency range, excellent return loss, very low insertion loss and excellent temperature stability. Precision coaxial connector interfaces ensure an excellent impedance match across wide bandwidths, and come in a variety of RF coaxial connector types (3.5 mm, 2.4 mm and 1.85 mm) to meet your application needs.

The Keysight N9398C/F/G and N9399C/F DC blocks are assembled and tested on Keysight precision network analyzers to assure full specifications over their entire frequency range.

Applications

Ruggedness and reliability make these DC blocks suitable for use on the bench and in systems. With low SWR and Insertion loss, they are ideally suited for suppressing DC signals which may affect the accuracy of your microwave and RF measurements or even damage your instruments.

The N9398C/F/G and N9399C/F DC blocks place the capacitance in series with the center conductor, preventing DC signals from flowing along the center conductor which can inadvertently bias other active components. These DC blocks provide good value with excellent broadband performance from 50 kHz to 50 GHz and 700 kHz to 67 GHz at a reasonable cost.

Sample Applications:

1. Amplifier Biasing

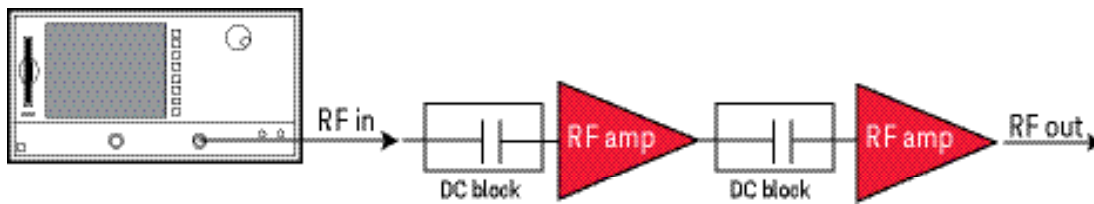

Figure 1. Typical application

DC blocks help prevent any DC signals entering the amplifier and creating a DC offset by acting as a high pass filter. A DC block also can be placed in between two RF amplifier stages to prevent any DC signal from the 1st stage entering the next amplifier stage.

2. Surge Arrestor

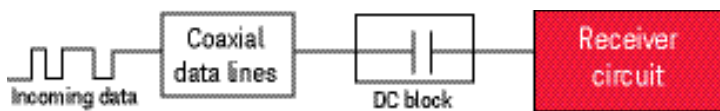

Figure 2. Typical application

Telecommunications based customers may use the DC blocks as surge arrestors before the incoming coaxial data lines are fed into their systems. Here the DC block protects the receiver circuit from any instantaneous voltage surge by absorbing the excess voltage.

Specifications

Specifications describe the product's warranted performance. Supplemental and typical characteristics are intended to provide typical but non-warranted performance parameters. These are denoted as "typical", "nominal" or "approximate".

Model	N9398C	N9399C	N9398F	N9399F	N9398G
Frequency range	50 kHz to 26.5 GHz	700 kHz to 26.5 GHz	50 kHz to 50 GHz	700 kHz to 50 GHz	700 kHz to 67 GHz
Insertion loss	0.9 dB	1.2 dB	0.9 dB (50 kHz to 26.5 GHz) 1.0 dB (26.5 to 50 GHz)	1.2 dB	0.9 dB (700 kHz to 26.5 GHz) 1.0 dB (26.5 to 67 GHz)
Return loss	10 dB (50 to 300 kHz) 17 dB (300 kHz to 26.5 GHz)	10 dB (700 kHz to 2 MHz) 17 dB (2 MHz to 26.5 GHz)	10 dB (50 to 300 kHz) 15 dB (300 kHz to 50 GHz)	10 dB (700 kHz to 2 MHz) 15 dB (2 MHz to 50 GHz)	10 dB (700 kHz to 2 MHz) 15 dB (2 MHz to 67 GHz)
Rise time	3 ps (typical)	3 ps (typical)	2 ps (typical)	2 ps (typical)	2 ps (typical)
Group delay	118 ps (typical)	118 ps (typical)	78 ps (typical)	78 ps (typical)	76 ps (typical)
Max DC working voltage	16 V	50 V	16 V	50 V	16 V
Connector type	3.5 mm (m-f)	3.5 mm (m-f)	2.4 mm (m-f)	2.4 mm (m-f)	1.85 mm (m-f)
Max RF power*	1 W average	1 W average	1 W average	1 W average	1 W average

* Max peak power = $\frac{\text{Max average power}}{\text{Duty cycle}}$ with condition of pulse width less than 1 μs

Environmental Specifications

The N9398C/F/G and N9399C/F DC blocks are designed to fully comply with Keysight RF network and spectrum analyzers operating within environmental specifications. The following summarizes the environmental specifications for these products.

Temperature	
Operating	-25° C to +80° C (N9398C/F/G), -50° C to +100° C (N9399C/F)
Storage	-65° C to +115° C (N9398C/F, N9399C/F), -55° C to +100° C (N9398G)
Cycling	-65° C to +115° C (N9398C/F, N9399C/F), -55° C to +100° C (N9398G), 10 cycles at 20° C per minute, 20 minutes dwell time per MIL-STD-833F, Method 1010.8, Condition C (modified)
Humidity	
Operating	50% to 95% RH at 40° C, 24 hour cycling, 5 times
Shock	
Half-sine, smoothed	1000 G at 0.5 ms, 3 shock pulses per orientation, 18 total per MIL-STD-833F, Method 2002.4, Condition B (modified)
Vibration	
Broadband random	50 to 2000 Hz, 7.0 G rms, 15 minutes, per MIL-STD-833F, Method 2026-1 (modified)
Altitude	
Storage	< 15,300 meters (50,000 feet)

Mechanical Dimensions

Model	Weight
N9398/9C	0.1 kg (0.22 lbs)
N9398/9F	0.1 kg (0.22 lbs)
N9398G	0.1 kg (0.22 lbs)

DC blocks N9398C and N9399C

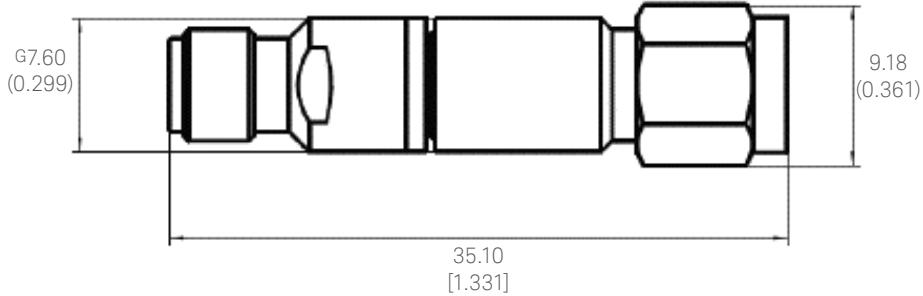

Figure 3. N9398/99C product outline

DC blocks N9398F and N9399F

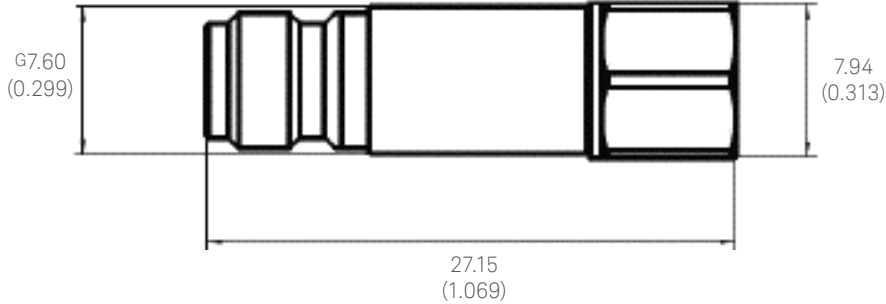

Figure 4. N9398/99F product outline

DC block N9398G

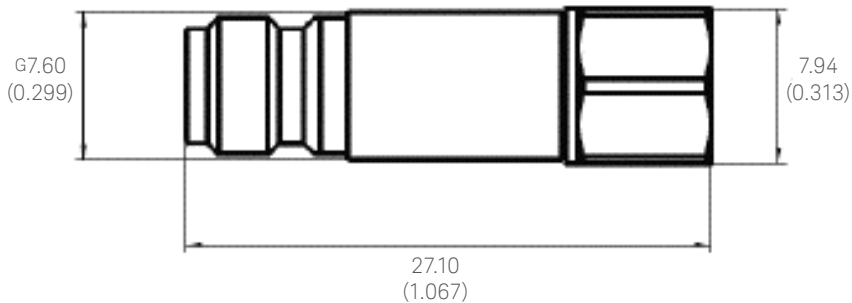

Figure 5. N9398G product outline

Dimensions are in mm (inches) nominal, unless otherwise specified.

Typical Performance

N9398C DC block return and insertion loss

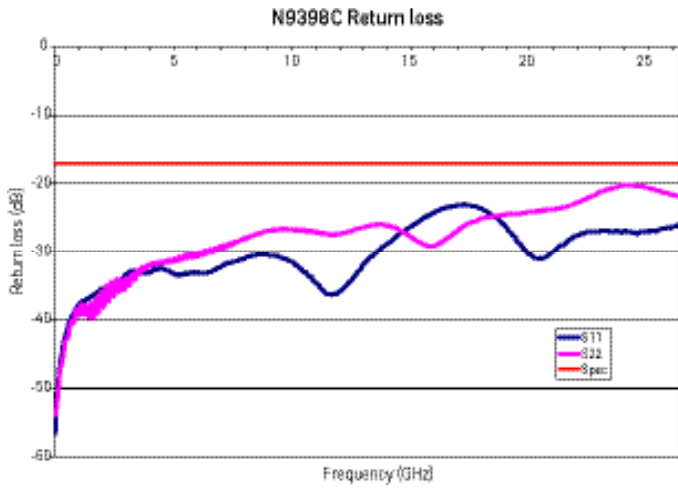

Figure 6. N9398C typical return loss versus frequency

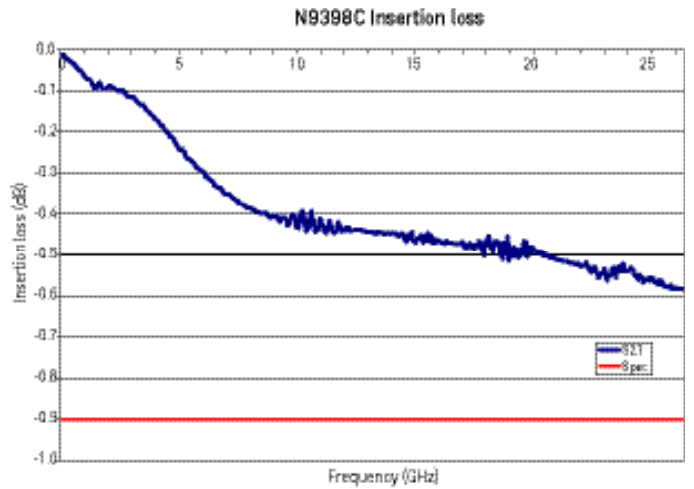

Figure 7. N9398C typical insertion loss versus frequency

N9399C DC block return and insertion loss

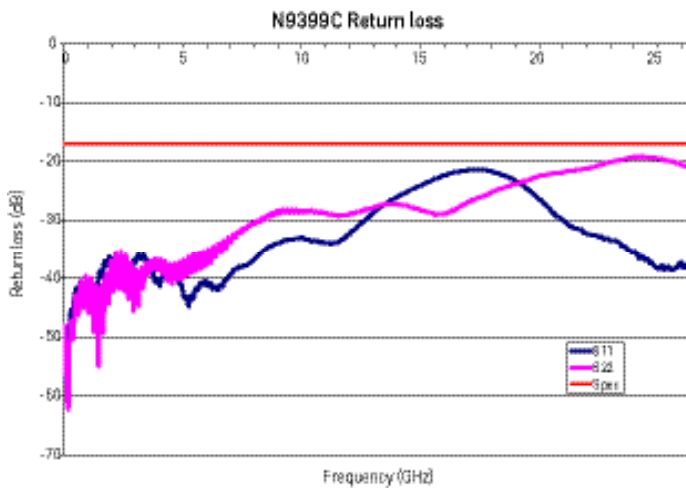

Figure 8. N9399C typical return loss versus frequency

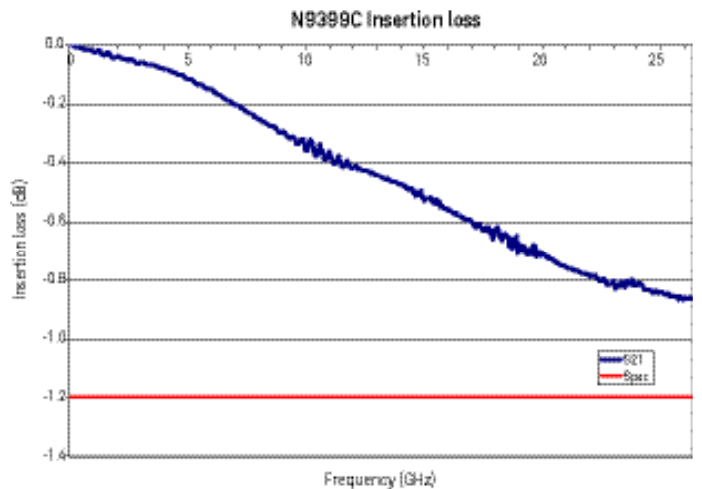

Figure 9. N9399C typical insertion loss versus frequency

Typical Performance – Continued

N9398F DC block return and insertion loss

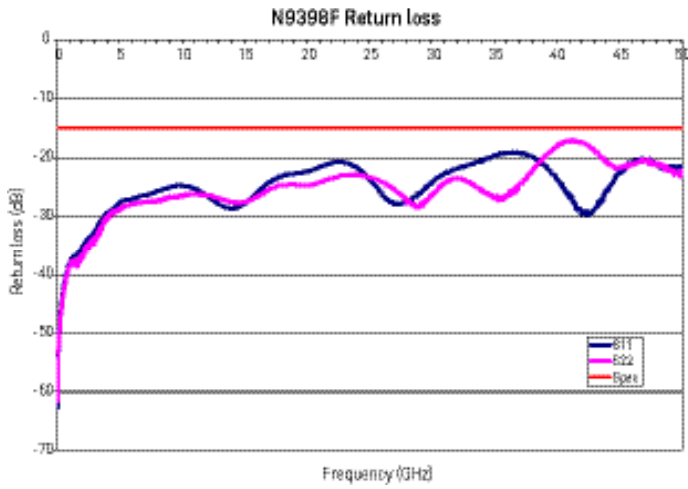

Figure 10. N9398F typical return loss versus frequency

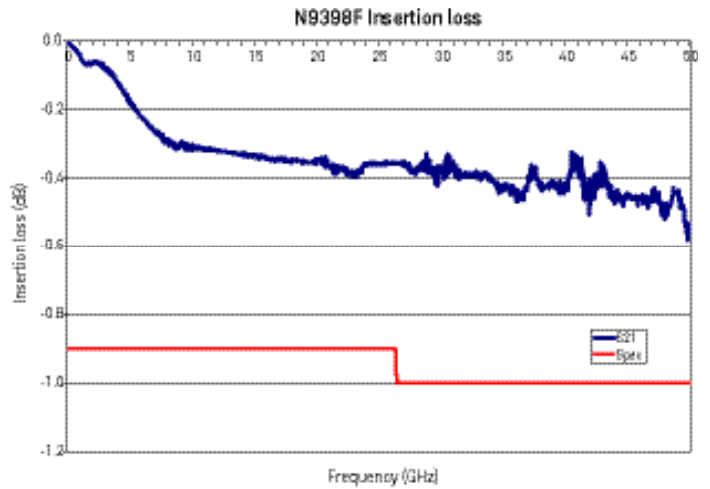

Figure 11. N9398F typical insertion loss versus frequency

N9399F DC block return and insertion loss

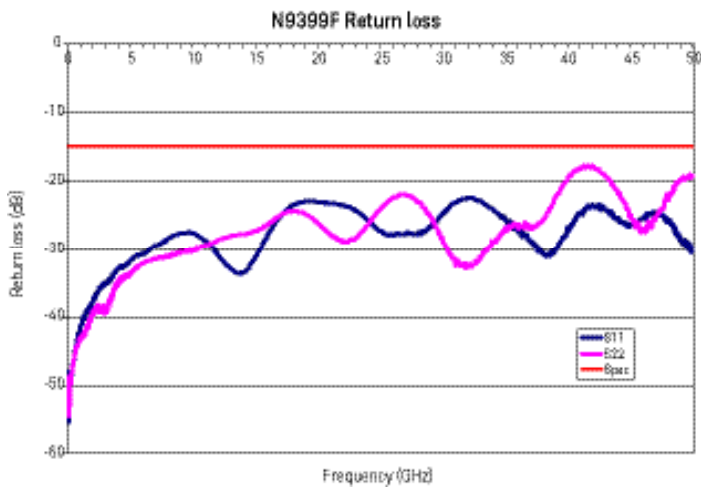

Figure 12. N9399F typical return loss versus frequency

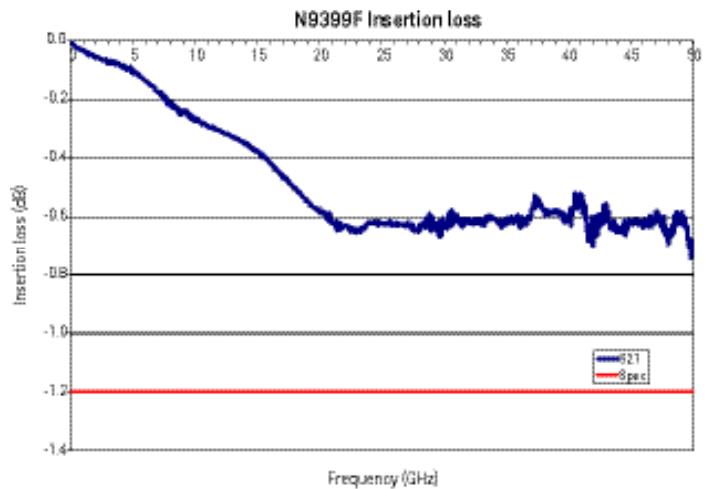

Figure 13. N9399F typical insertion loss versus frequency

Typical Performance – Continued

N9398G DC block return and insertion loss

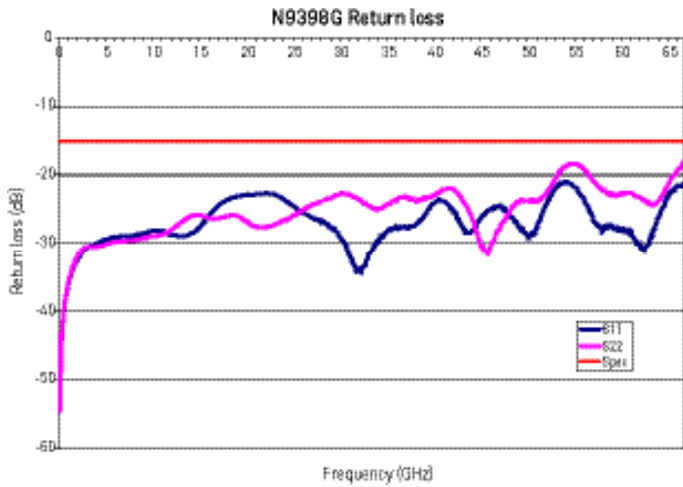

Figure 14. N9398G typical return loss versus frequency

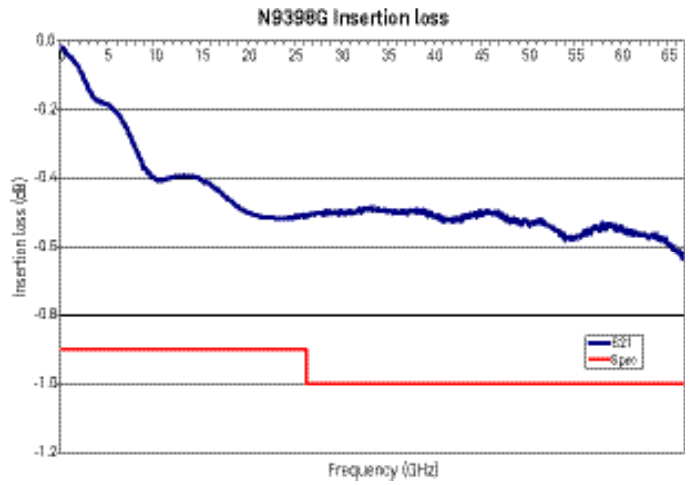

Figure 15. N9398G typical insertion loss versus frequency

Typical group delay

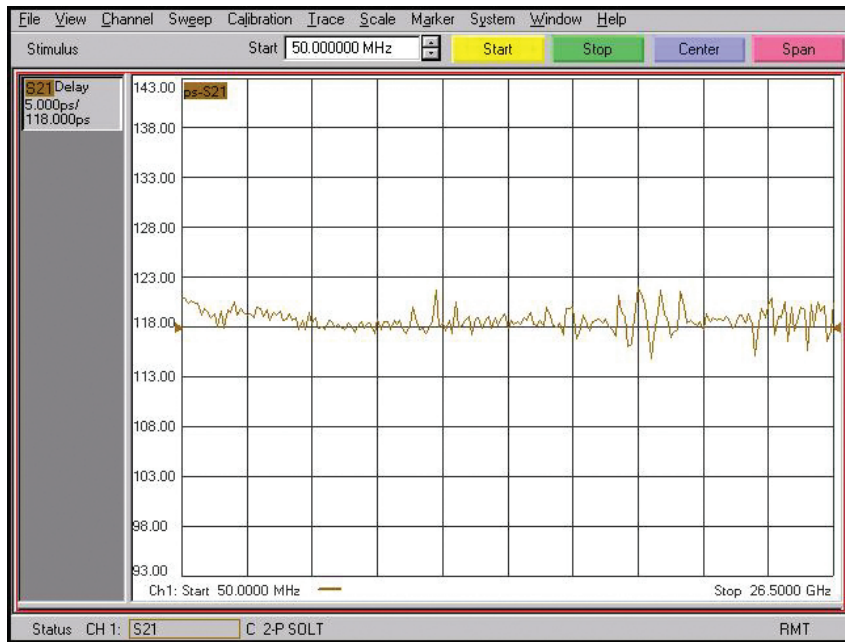

Figure 16. N9398C typical group delay

Typical Performance – Continued

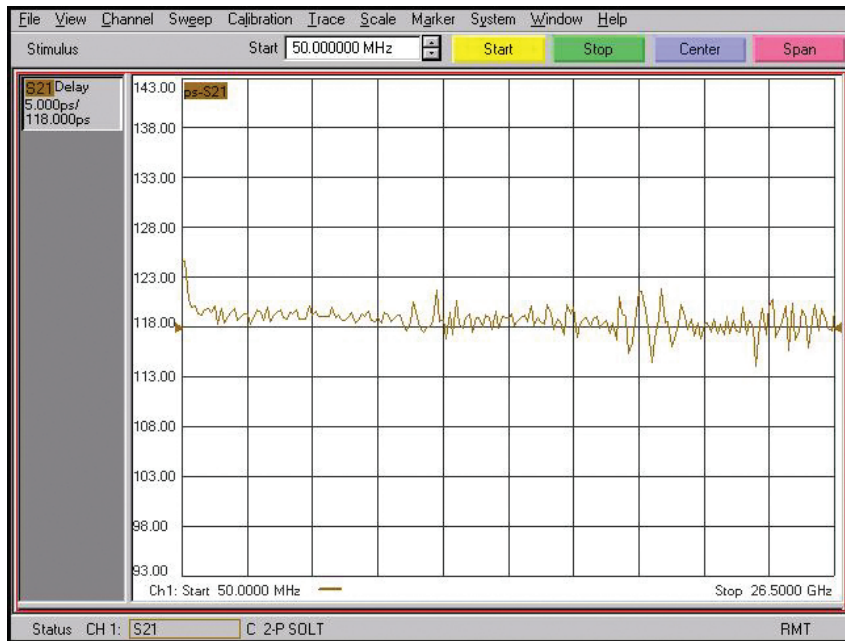

Figure 17. N9399C typical group delay

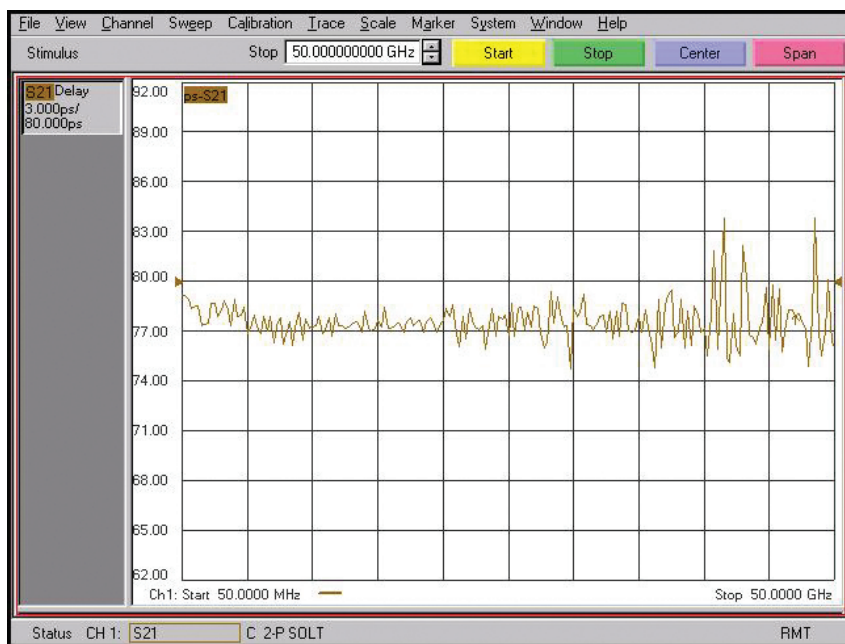

Figure 18. N9398F typical group delay

Typical Performance – Continued

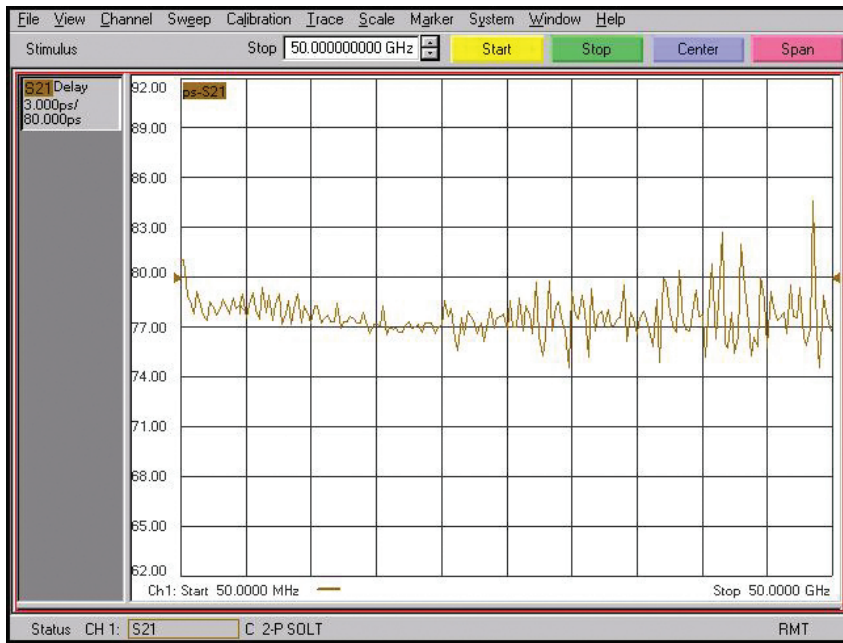

Figure 19. N9399F typical group delay

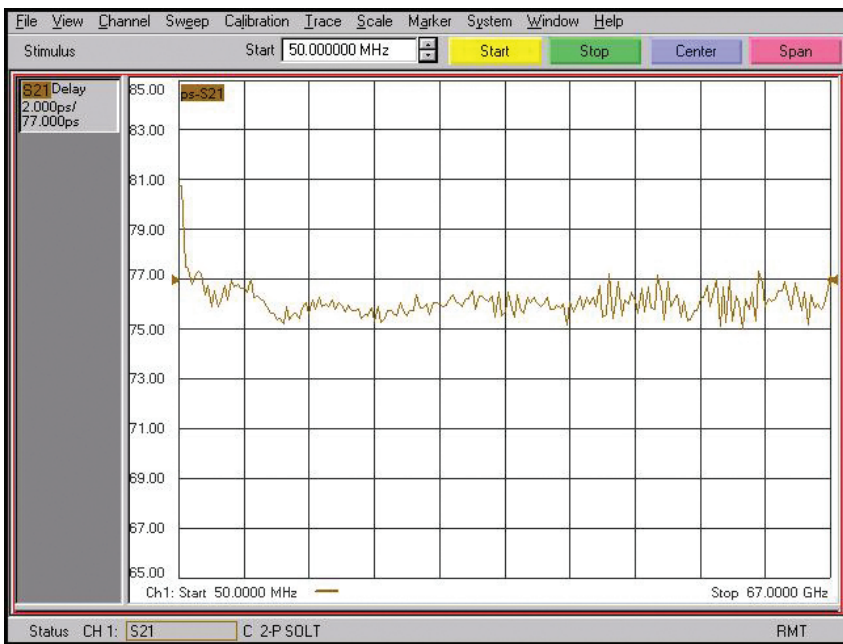

Figure 20. N9398G typical group delay

Ordering Information

N9398C	3.5 mm, 16 V 50 kHz to 26.5 GHz, DC block
N9399C	3.5 mm, 50 V 700 kHz to 26.5 GHz, DC block
N9398F	2.4 mm, 16 V 50 kHz to 50 GHz, DC block
N9399F	2.4 mm, 16 V 700 kHz to 50 GHz, DC block
N9398G	1.85 mm, 16 V 700 kHz to 67 GHz, DC block

Related Product Literature

Keysight N9398C/F/G and N9399C/F DC Blocks Flyer,
literature number 5989-5519EN

Web Resource

www.keysight.com/find/mta

Evolving Since 1939

Our unique combination of hardware, software, services, and people can help you reach your next breakthrough. We are unlocking the future of technology.

From Hewlett-Packard to Agilent to Keysight.

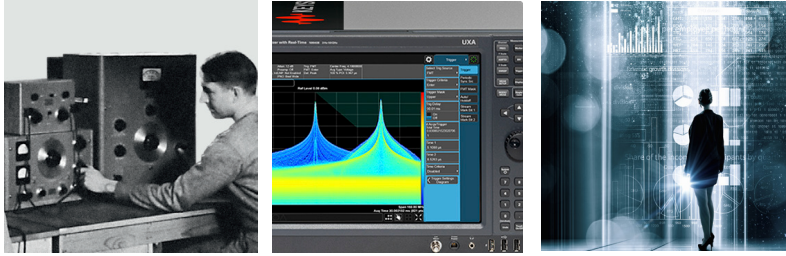

For more information on Keysight Technologies' products, applications or services, please contact your local Keysight office. The complete list is available at:

www.keysight.com/find/contactus

Americas

Canada	(877) 894 4414
Brazil	55 11 3351 7010
Mexico	001 800 254 2440
United States	(800) 829 4444

Asia Pacific

Australia	1 800 629 485
China	800 810 0189
Hong Kong	800 938 693
India	1 800 11 2626
Japan	0120 (421) 345
Korea	080 769 0800
Malaysia	1 800 888 848
Singapore	1 800 375 8100
Taiwan	0800 047 866
Other AP Countries	(65) 6375 8100

Europe & Middle East

Austria	0800 001122
Belgium	0800 58580
Finland	0800 523252
France	0805 980333
Germany	0800 6270999
Ireland	1800 832700
Israel	1 809 343051
Italy	800 599100
Luxembourg	+32 800 58580
Netherlands	0800 0233200
Russia	8800 5009286
Spain	800 000154
Sweden	0200 882255
Switzerland	0800 805353
	Opt. 1 (DE)
	Opt. 2 (FR)
	Opt. 3 (IT)
United Kingdom	0800 0260637

For other unlisted countries:

www.keysight.com/find/contactus
(BP-9-7-17)

DEKRA Certified
ISO 9001 Quality Management System

www.keysight.com/go/quality
Keysight Technologies, Inc.
DEKRA Certified ISO 9001:2015
Quality Management System

myKeysight

myKeysight

www.keysight.com/find/mykeysight

A personalized view into the information most relevant to you.

www.keysight.com/find/emt_product_registration

Register your products to get up-to-date product information and find warranty information.

KEYSIGHT SERVICES

Accelerate Technology Adoption.
Lower costs.

Keysight Services

www.keysight.com/find/service

Keysight Services can help from acquisition to renewal across your instrument's lifecycle. Our comprehensive service offerings—one-stop calibration, repair, asset management, technology refresh, consulting, training and more—helps you improve product quality and lower costs.



Keysight Assurance Plans

www.keysight.com/find/AssurancePlans

Up to ten years of protection and no budgetary surprises to ensure your instruments are operating to specification, so you can rely on accurate measurements.

Keysight Channel Partners

www.keysight.com/find/channelpartners

Get the best of both worlds: Keysight's measurement expertise and product breadth, combined with channel partner convenience.

www.keysight.com/find/mta



This information is subject to change without notice.
© Keysight Technologies, 2006, 2011 - 2017
Published in USA, December 1, 2017
5989-4544EN
www.keysight.com