

# BECKHOFF

# CB3056

## Manual

rev. 1.6

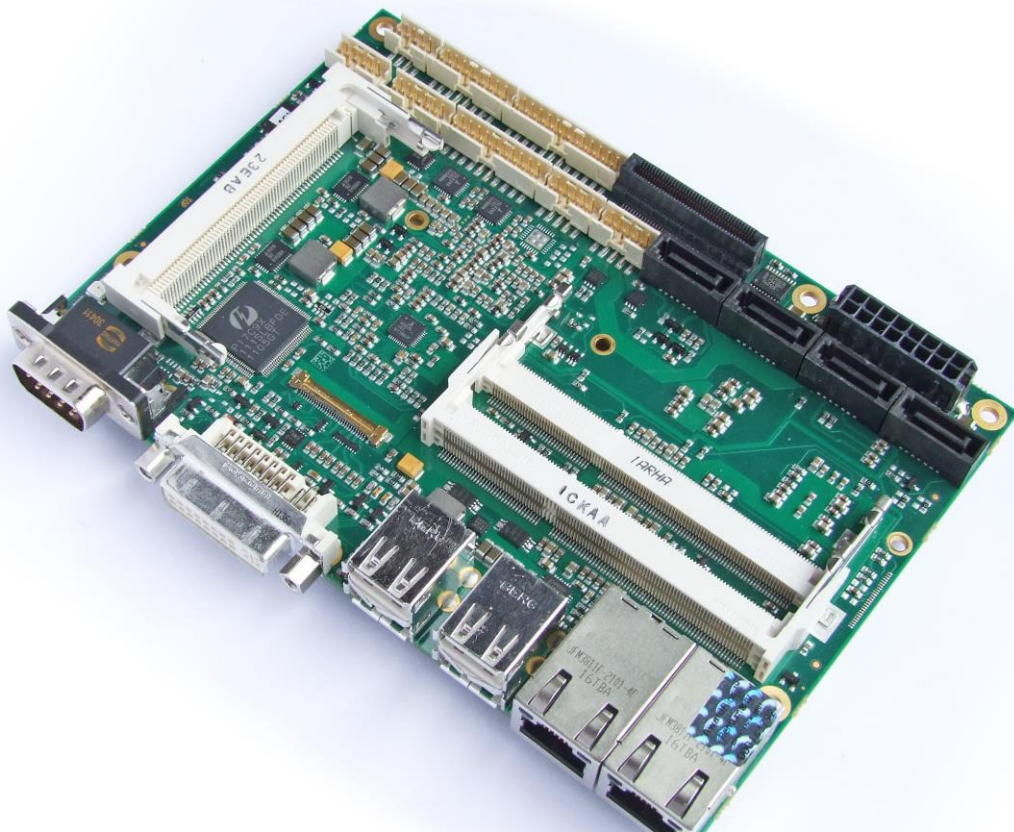



# Contents

0	Document History.....	6
1	Introduction .....	7
1.1	Notes on the Documentation .....	7
1.1.1	Liability Conditions .....	7
1.1.2	Copyright.....	7
1.2	Safety Instructions .....	8
1.2.1	Disclaimer .....	8
1.2.2	Description of Safety Symbols .....	9
1.3	Essential Safety Measures .....	10
1.3.1	Operator's Obligation to Exercise Diligence .....	10
1.3.2	National Regulations Depending on the Machine Type .....	10
1.3.3	Operator Requirements .....	10
1.4	Functional Range.....	11
2	Overview .....	12
2.1	Features.....	12
2.2	Specifications and Documents .....	14
3	Connectors .....	15
3.1	Connector Map .....	16
3.2	CPU Socket .....	17
3.3	Power Supply.....	18
3.4	System .....	19
3.5	Memory.....	20
3.6	VGA/DVI .....	23
3.7	DVI/HDMI/DisplayPort .....	25
3.8	USB 1-4 .....	27
3.9	USB 5-10 .....	28
3.10	LAN .....	29
3.11	Audio.....	30
3.12	SATA Interfaces.....	31
3.13	Serial Interface COM1 .....	32
3.14	Serial Ports COM2 through COM4 .....	33
3.15	PCI-Express.....	35
3.16	Mini-PCI .....	37
3.17	GPIO .....	39
3.18	Fan Connectors .....	40
4	BIOS Settings.....	41
4.1	General Remarks.....	41
4.2	Main .....	42
4.3	Advanced.....	44
4.3.1	PCI Subsystem Settings .....	46
4.3.2	ACPI Settings.....	48
4.3.3	CPU Configuration .....	49
4.3.4	SATA Configuration .....	51
4.3.5	Power Controller Options.....	52
4.3.6	USB Configuration .....	54
4.3.7	Super IO Configuration .....	55

## Contents

---

4.3.8	H/W Monitor .....	57
4.3.9	Serial Port Console Redirection.....	59
4.3.10	Network Stack.....	61
4.3.11	CPU PPM Configuration .....	62
4.3.12	Intel(R) GigabitNetworkConnection .....	63
4.4	Chipset.....	65
4.4.1	PCH-IO Configuration .....	66
4.4.2	System Agent (SA) Configuration.....	73
4.5	Boot.....	81
4.5.1	CSM Parameters .....	83
4.6	Security .....	84
4.6.1	Secure Boot Policy .....	85
4.6.2	Key Management.....	86
4.7	Save & Exit .....	88
4.8	BIOS-Update .....	89
5	Mechanical Drawings .....	90
5.1	PCB: Mounting Holes .....	90
5.2	PCB: Pin 1 Dimensions .....	91
5.3	PCB: Die Center .....	92
6	Technical Data .....	93
6.1	Electrical Data.....	93
6.2	Environmental Conditions.....	93
6.3	Thermal Specifications .....	94
7	Support and Service .....	95
7.1	Beckhoff's Branch Offices and Representatives .....	95
7.2	Beckhoff Headquarters .....	95
7.2.1	Beckhoff Support .....	95
7.2.2	Beckhoff Service .....	95
I	Annex: Post-Codes .....	97
II	Annex: Resources.....	98
	IO Range .....	98
	Memory Range.....	98
	Interrupt .....	98
	PCI Devices.....	99
	SMB Devices .....	99



## 0 Document History

Version	Changes
0.1	first pre-release
1.0	first complete version
1.1	max RAM updated to 16 GB, BIOS setup features updated.
1.2	new HDMI/DP connector, resulting in new feature list (one more USB channel), new block diagram and new dimensional drawings
1.3	updated BIOS settings
1.4	updated pinout COM 2-4
1.5	updated BIOS settings
1.6	corrected LAN pinout; corrected FAN pinout



### **NOTE**

All company names, brand names, and product names referred to in this manual are registered or unregistered trademarks of their respective holders and are, as such, protected by national and international law.

# 1 Introduction

## 1.1 Notes on the Documentation

This description is only intended for the use of trained specialists in control and automation engineering who are familiar with the applicable national standards. It is essential that the following notes and explanations are followed when installing and commissioning these components.

### 1.1.1 Liability Conditions

The responsible staff must ensure that the application or use of the products described satisfy all the requirements for safety, including all the relevant laws, regulations, guidelines and standards. The documentation has been prepared with care. The products described are, however, constantly under development. For that reason the documentation is not in every case checked for consistency with performance data, standards or other characteristics. None of the statements of this manual represents a guarantee (Garantie) in the meaning of § 443 BGB of the German Civil Code or a statement about the contractually expected fitness for a particular purpose in the meaning of § 434 par. 1 sentence 1 BGB. In the event that it contains technical or editorial errors, we retain the right to make alterations at any time and without warning. No claims for the modification of products that have already been supplied may be made on the basis of the data, diagrams and descriptions in this documentation.

### 1.1.2 Copyright

© This documentation is copyrighted. Any reproduction or third party use of this publication, whether in whole or in part, without the written permission of Beckhoff Automation GmbH, is forbidden.

## 1.2 Safety Instructions

Please consider the following safety instructions and descriptions. Product specific safety instructions are to be found on the following pages or in the areas mounting, wiring, commissioning etc.

### 1.2.1 Disclaimer

All the components are supplied in particular hardware and software configurations appropriate for the application. Modifications to hardware or software configurations other than those described in the documentation are not permitted, and nullify the liability of Beckhoff Automation GmbH.



## 1.2.2 Description of Safety Symbols

The following safety symbols are used in this documentation. They are intended to alert the reader to the associated safety instructions.



### ***ACUTE RISK OF INJURY!***

If you do not adhere to the safety advise next to this symbol, there is immediate danger to life and health of individuals!



### ***RISK OF INJURY!***

If you do not adhere to the safety advise next to this symbol, there is danger to life and health of individuals!



### ***HAZARD TO INDIVIDUALS, ENVIRONMENT, DEVICES, OR DATA!***

If you do not adhere to the safety advise next to this symbol, there is obvious hazard to individuals, to environment, to materials, or to data.



### ***NOTE OR POINTER***

This symbol indicates information that contributes to better understanding.

## 1.3 Essential Safety Measures

### 1.3.1 Operator's Obligation to Exercise Diligence

The operator must ensure that

- the product is only used for its intended purpose
- the product is only operated in sound condition and in working order
- the instruction manual is in good condition and complete, and always available for reference at the location where the products are used
- the product is only used by suitably qualified and authorised personnel
- the personnel is instructed regularly about relevant occupational safety and environmental protection aspects
- the operating personnel is familiar with the operating manual and in particular the safety notes contained herein

### 1.3.2 National Regulations Depending on the Machine Type

Depending on the type of machine and plant in which the product is used, national regulations governing the controllers of such machines will apply, and must be observed by the operator. These regulations cover, amongst other things, the intervals between inspections of the controller. The operator must initiate such inspections in good time.

### 1.3.3 Operator Requirements

- Read the operating instructions

All users of the product must have read the operating instructions for the system they work with.

- System know-how

All users must be familiar with all accessible functions of the product.

## 1.4 Functional Range



### ***NOTE***

The descriptions contained in the present documentation represent a detailed and extensive product description. As far as the described motherboard was acquired as an integral component of an Industrial PC from Beckhoff Automation GmbH, this product description shall be applied only in limited scope. Only the contractually agreed specifications of the corresponding Industrial PC from Beckhoff Automation GmbH shall be relevant. Due to several models of Industrial PCs, variations in the component placement of the motherboards are possible. Support and service benefits for the built-in motherboard will be rendered by Beckhoff Automation GmbH exclusively as specified in the product description (inclusive operation system) of the particular Industrial PC.

## 2 Overview

### 2.1 Features

The CB3056 is a highly complex 3,5-inch board which incorporates complete motherboard functionality. It's based on Intel®'s QM67 chipset combined with an rPGA988B CPU socket for Intel® CPUs of the 2nd Generation Core™ and Celeron® families. Modern DDR3 technology provides top-notch memory performance, accommodating up to 16 GByte of RAM (DDR3-1066/1333/1600) via SO-DIMM204. It also provides a PCI bus (via mPCI connector), a PCI-Express bus (via a 2x40 pin custom connector) and additional peripheral devices such as four serial interfaces, two Gigabit Ethernet interfaces (LAN), four SATA channels (two of which offering up to 6Gb/s), an audio interface (HDA 5.1), eleven USB channels, and two DVI/HDMI connectors with CRT available through DVI-I, and DisplayPort available on a 30pin I-PEX connector.

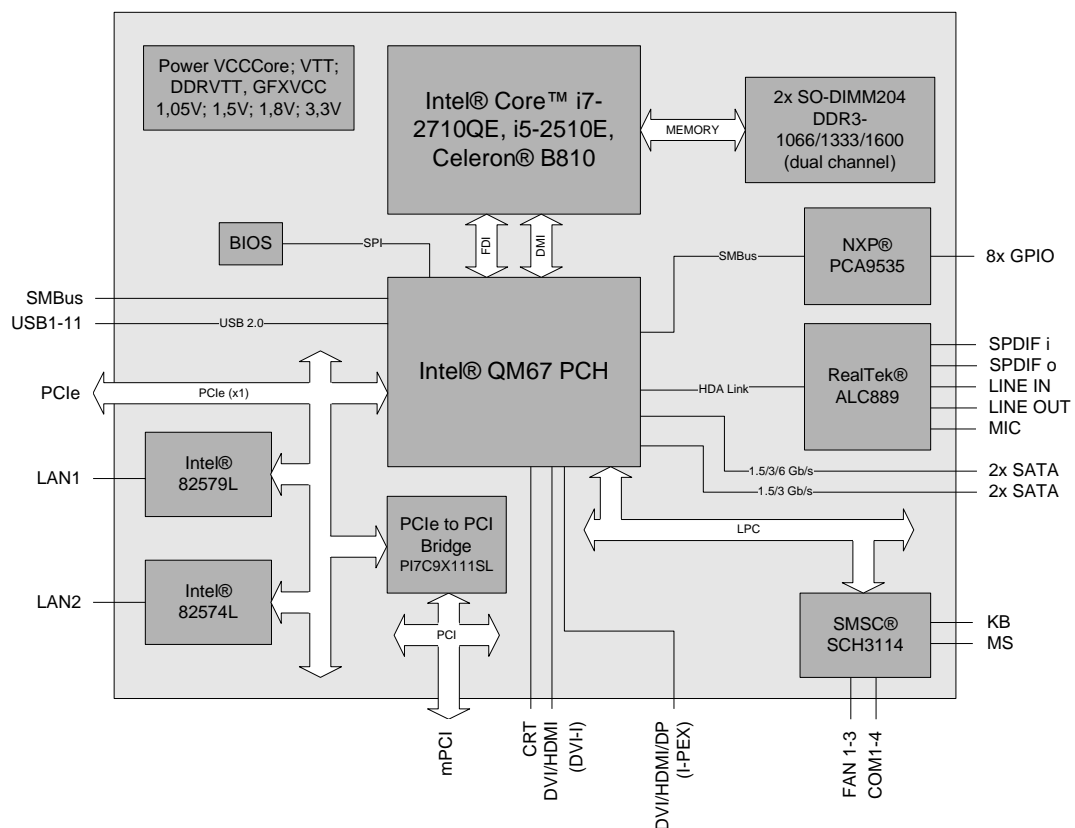

- Socket rPGA988B
- Suitable CPUs: Intel® Core™ i7-2710QE, i5-2510E, Celeron® B810
- Chipset Intel® QM67 PCH
- Two SO-DIMM204 sockets for up to 16 GByte DDR3-1066/1333/1600 RAM
- PCI bus via mPCI connector
- PCI-Express bus (four x1 or one x4) via 2x40pin custom connector
- Four serial interfaces COM1 to COM4
- Two LAN interfaces Ethernet 10/100/1000 (Base-T)
- Four SATA channels (two of which up to 6Gb/s transfer rate)
- PS2 keyboard / mouse interface
- 11 USB 2.0 interfaces (4x external, 6x internal, 1x on I-PEX connector)
- BIOS AMI® Aptio

- CRT connection
- Two DVI/HDMI connectors (1x DVI-I, 1x I-PEX with DisplayPort capability)
- HDA compatible sound controller with SPDIF in and out
- 8x GPIO
- RTC with external CMOS battery
- 5V supply
- Format: 102 mm x 147 mm

## 2.2 Specifications and Documents

In making this manual and for further reading of technical documentation, the following documents, specifications and web-pages were used and are recommended.

- PCI specification  
Version 2.3 resp. 3.0  
[www.pcisig.com](http://www.pcisig.com)
- Mini-PCI specification  
Version 1.0  
[www.pcisig.com](http://www.pcisig.com)
- PCI Express® Base specification  
Version 2.0  
[www.pcisig.com](http://www.pcisig.com)
- ACPI specification  
Version 3.0  
[www.acpi.info](http://www.acpi.info)
- USB specifications  
[www.usb.org](http://www.usb.org)
- SM-Bus specification  
Version 2.0  
[www.smbus.org](http://www.smbus.org)
- Intel® Chip Description  
2nd Gen. Intel® Core™ Processor Family Mobile datasheet  
[www.intel.com](http://www.intel.com)
- Intel® Chipset Description  
Intel® 6 Series Chipset datasheet  
[www.intel.com](http://www.intel.com)
- Intel® Chip Description  
82574L Datasheet  
[www.intel.com](http://www.intel.com)
- Intel® Chip Description  
82579L Datasheet  
[www.intel.com](http://www.intel.com)
- Realtek® Chip Description  
ALC885/889 Datasheet  
[www.realtek.com.tw](http://www.realtek.com.tw)
- SMSC® Chip Description  
SCH3114 Datasheet  
[www.smsc.com](http://www.smsc.com)  
(NDA required)
- American Megatrends®  
Aptio™ Text Setup Environment (TSE) User Manual  
[www.ami.com](http://www.ami.com)
- American Megatrends®  
Aptio™ 4.x Status Codes  
[www.ami.com](http://www.ami.com)

### 3 Connectors

This section describes all the connectors found on the CB3056.



#### **CAUTION**

For most interfaces, the cables must meet certain requirements. For instance, USB 2.0 requires twisted and shielded cables to reliably maintain full speed data rates. Restrictions on maximum cable length are also in place for many high speed interfaces and for power supply. Please refer to the respective specifications and use suitable cables at all times.

### 3.1 Connector Map

Please use the connector map below for quick reference. Only connectors on the component side are shown. For more information on each connector refer to the table below.

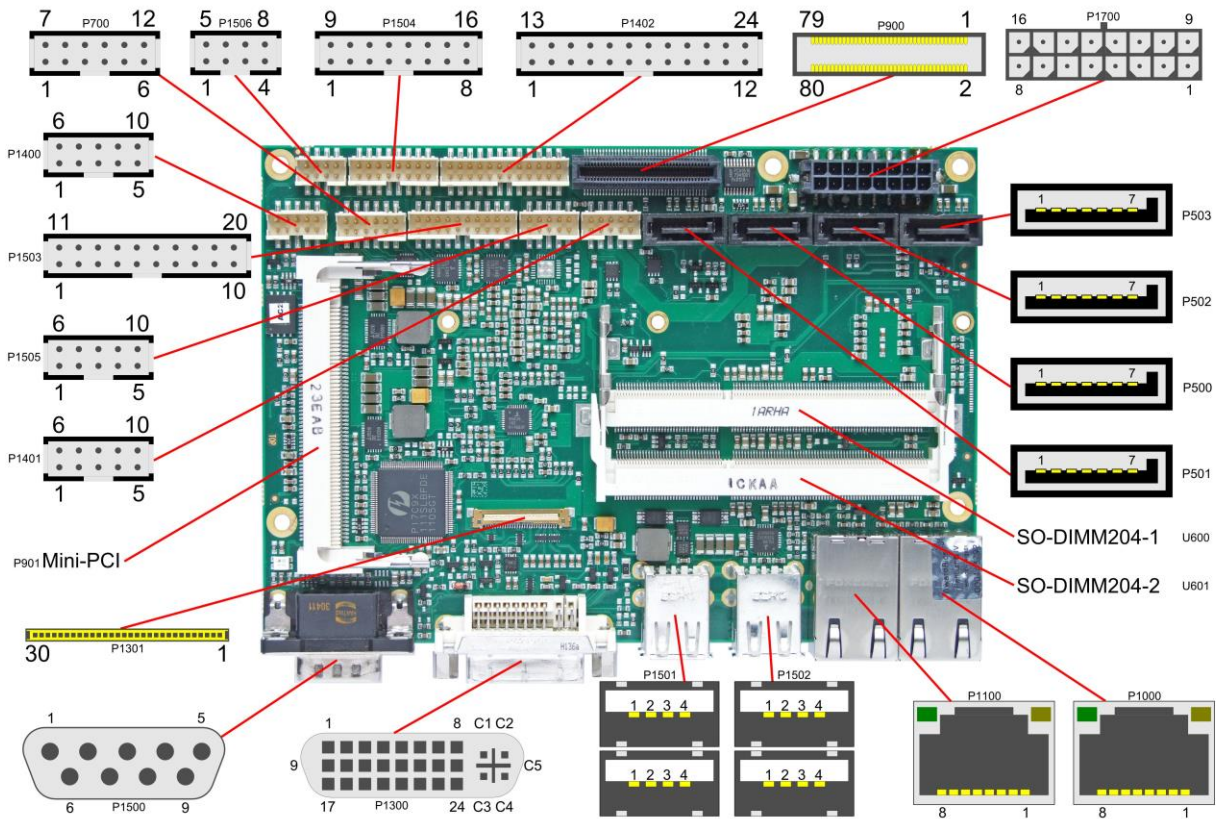

Ref-No.	Function	Page
P500/1/2/3	"SATA Interfaces"	p. 31
U600/1	"Memory"	p. 20
P700	"GPIO"	p. 39
P900	"PCI-Express"	p. 35
P901	"Mini-PCI"	p. 37
P1000/1100	"LAN"	p. 29
P1300	"VGA/DVI"	p. 23
P1301	"DVI/HDMI/DisplayPort"	p. 25
P1400	"Audio"	p. 30
P1401	"Fan Connectors"	p. 40
P1402	"System"	p. 19
P1500	"Serial Interface COM1"	p. 32
P1503/5	"Serial Ports COM2 through COM4"	p. 33
P1501/2	"USB 1-4"	p. 27
P1504/6	"USB 5-10"	p. 28
P1700	"Power Supply"	p. 18



## 3.2 CPU Socket

The CB3056 board has an rPGA988B CPU socket accommodating certain models of Intel®'s 2nd Generation Core™ and Celeron® family CPUs. The rPGA988B is a ZIF (Zero Insertion Force) socket, which means that you can insert the processor without there being any resistance. There is only one orientation in which the processor will fit into the socket. Once the processor is in place the fastening screw must be tightened to ensure proper electrical contact.

The package type allows a maximum die temperature of 100 degrees Celsius and accords highest possible security even in rough environment.

The processor includes a second level cache of up to 6 MByte, depending on which model is used.

Furthermore the processors offer many features known from the desktop range such as MMX2, serial number, loadable microcode etc.



### NOTE

Processors must be ordered separately. The board ships without a CPU.

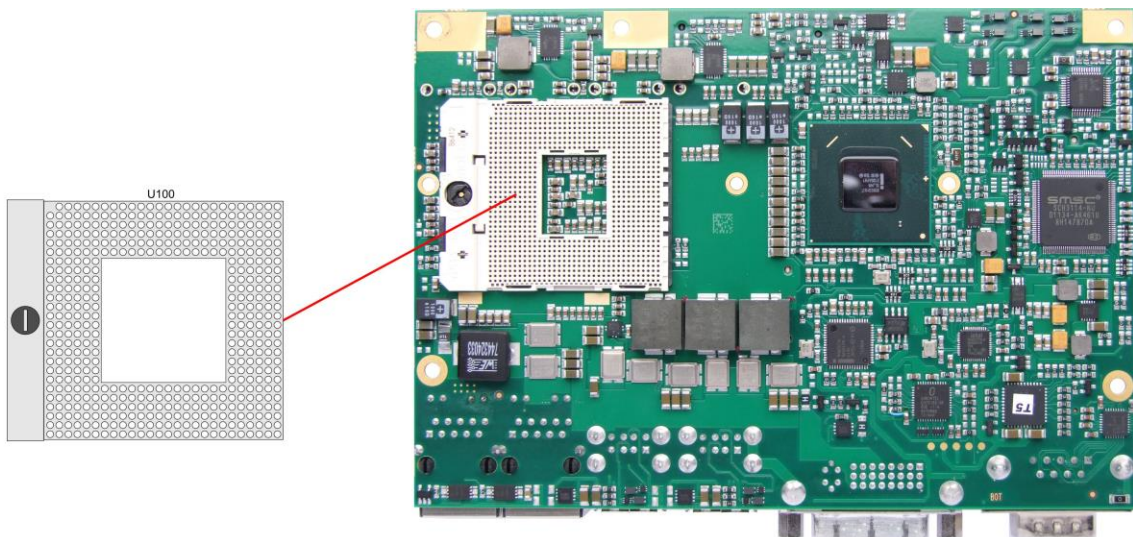

### 3.3 Power Supply

The power supply of the hardware module is realized via a 2x8-pin connector (Molex PS 43045-1619, mating connector: Molex PS 43025-16xx). The 12 volt supply is needed for PCI-Express cards and for the fan connector. COM3 RXD and TXD can also be used for connecting a second power supply unit, e. g. for UPS. As an ordering option SMBus signals SCL/SDA can be provided (replacing COM3 TXD/RXD).

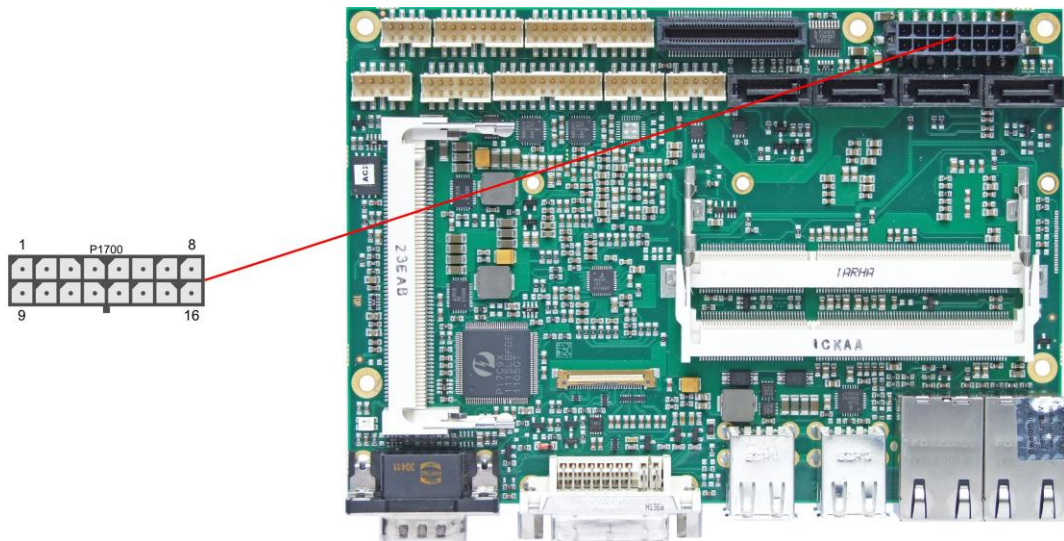

Description	Name	Pin	Name	Description	
COM3 transmit data	TXD	1	9	RXD	COM3 receive data
PSU on	PS-ON	2	10	PWRGD	Powergood
powerbutton PSU	PWRBTN#	3	11	SVCC	standby-supply 5V
12 volt supply	12V	4	12	12V	12 volt supply
ground	GND	5	13	GND	ground
ground	GND	6	14	GND	ground
5 volt supply	VCC	7	15	VCC	5 volt supply
5 volt supply	VCC	8	16	VCC	5 volt supply

### 3.4 System

A number of signals for system control and for SMBus communication are provided through a 2x12 pin connector (FCI 98424-G52-24LF, mating connector FCI 90311-024LF). This connector combines signals for power button, reset, keyboard, speaker, and several LEDs such as harddisk LED, and suspend LED, and three additional LEDs which are driven by GPIOs. Of these three GPIO-LEDs, LED1 and LED2 are already provided with a series resistor. SMBus capable devices can also be connected.

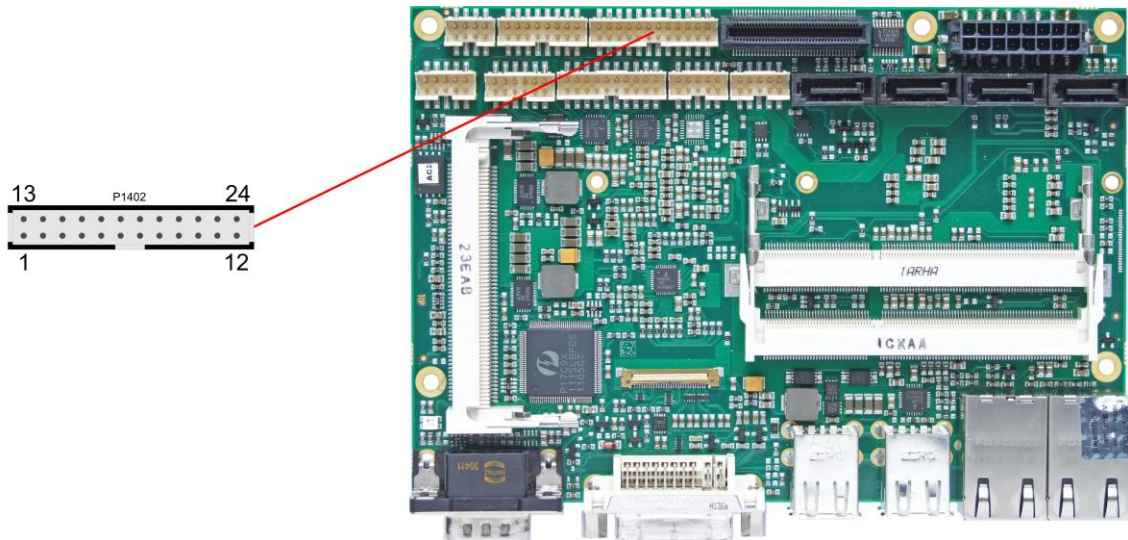

Pinout 2x12pin connector:

Description	Name	Pin	Name	Description
ground	GND	1	13	3.3V 3.3V supply
reset to ground	RSTBTN#	2	14	PWRBTN# on/suspend button
LED suspend / ACPI	S-LED	3	15	S3.3V standby supply 3.3V
LED harddisk	SATALED	4	16	GPIOLED3 LED GPIO device 3
LED GPIO device 1	GPIOLED1	5	17	BATT battery
LED GPIO device 2	GPIOLED2	6	18	SMBALERT# SMB alert
SMB Clock	SMBCLKEX	7	19	SMBDATEX SMB data
speaker to 5V	SPEAKER	8	20	SVCC standby supply 5V
keyboard clock	KCLK	9	21	KDAT keyboard data
ground	GND	10	22	VCC 5V supply
ground	GND	11	23	VCC 5V supply
ground	GND	12	24	VCC 5V supply

### 3.5 Memory

Conventional SO-DIMM204 memory modules, as familiar from notebook computers, are used to equip the board with memory. For technical and mechanical reasons it is possible that particular memory modules cannot be employed. Please ask your distributor for recommended memory modules.

With currently available SO-DIMM204 modules a memory extension up to 16 GByte is possible (DDR3-1066/1333/1600).

All timing parameters for different memory modules are automatically set by BIOS.

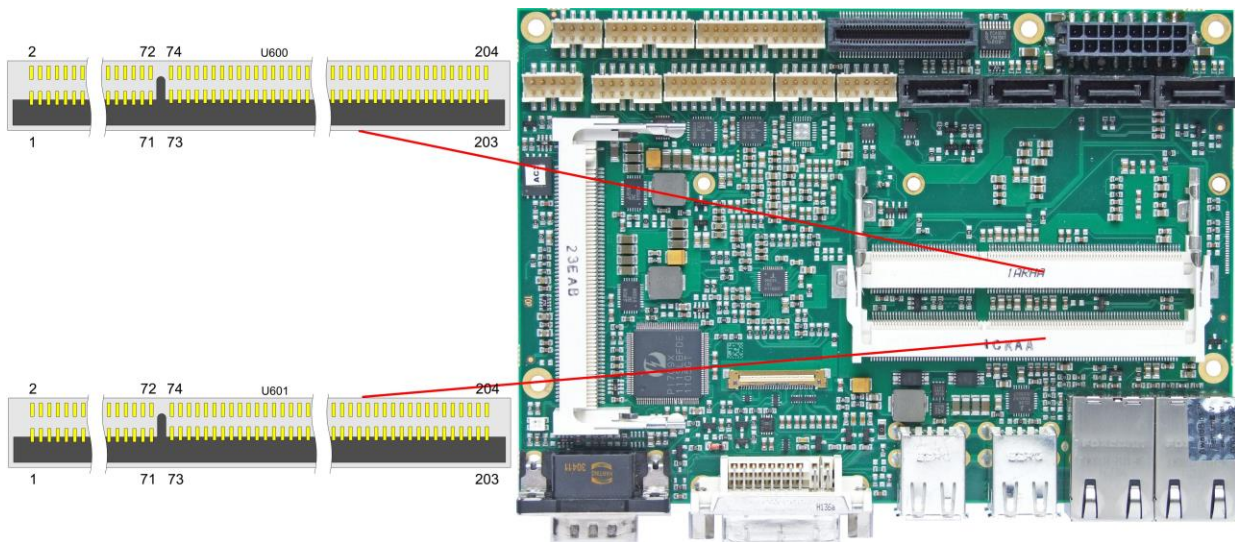

Pinout SO-DIMM204:

Description	Name	Pin	Name	Description
memory reference current	REF-DQ	1	2	GND
ground	GND	3	4	DQ4
data 0	DQ0	5	6	DQ5
data 1	DQ1	7	8	GND
ground	GND	9	10	DQS0#
data mask 0	DM0	11	12	DQS0
ground	GND	13	14	GND
data 2	DQ2	15	16	DQ6
data 3	DQ3	17	18	DQ7
ground	GND	19	20	GND
data 8	DQ8	21	22	DQ12
data 9	DQ9	23	24	DQ13
ground	GND	25	26	GND
data strobe 1 -	DQS1#	27	28	DM1
data strobe 1 +	DQS1	29	30	RESET#
ground	GND	31	32	GND
data 10	DQ10	33	34	DQ14
data 11	DQ11	35	36	DQ15
ground	GND	37	38	GND
data 16	DQ16	39	40	DQ20
data 17	DQ17	41	42	DQ21
ground	GND	43	44	GND
data strobe 2 -	DQS2#	45	46	DM2
data strobe 2 +	DQS2	47	48	GND
ground	GND	49	50	DQ22

Description	Name	Pin		Name	Description
data 18	DQ18	51	52	DQ23	data 23
data 19	DQ19	53	54	GND	ground
ground	GND	55	56	DQ28	data 28
data 24	DQ24	57	58	DQ29	data 29
data 25	DQ25	59	60	GND	ground
ground	GND	61	62	DQS3#	data strobe 3 -
data mask 3	DQM3	63	64	DQS3	data strobe 3 +
ground	GND	65	66	GND	ground
data 26	DQ26	67	68	DQ30	data 30
data 27	DQ27	69	70	DQ31	data 31
ground	GND	71	72	GND	ground
clock enables 0	CKE0	73	74	CKE1	clock enables 1
1.5 volt supply	1.5V	75	76	1.5V	1.5 volt supply
reserved	N/C	77	78	(A15)	reserved
SDRAM bank 2	BA2	79	80	A14	address 14
1.5 volt supply	1.5V	81	82	1.5V	1.5 volt supply
address 12 (burst chop)	A12/BC#	83	84	A11	address 11
address 9	A9	85	86	A7	address 7
1.5 volt supply	1.5V	87	88	1.5V	1.5 volt supply
address 8	A8	89	90	A6	address 6
address 5	A5	91	92	A4	address 4
1.5 volt supply	1.5V	93	94	1.5V	1.5 volt supply
address 3	A3	95	96	A2	address 2
address 1	A1	97	98	A0	address 0
1.5 volt supply	1.5V	99	100	1.5V	1.5 volt supply
Clock 0 +	CK0	101	102	CK1	clock 1 +
Clock 0 -	CK0#	103	104	CK1#	clock 1 -
1.5 volt supply	1.5V	105	106	1.5V	1.5 volt supply
address 10 (auto precharge)	A10/AP	107	108	BA1	SDRAM bank 1
SDRAM Bank 0	BA0	109	110	RAS#	row address strobe
1.5 volt supply	1.5V	111	112	1.5V	1.5 volt supply
write enable	WE#	113	114	S0#	chip select 0
column address strobe	CAS#	115	116	ODT0	on die termination 0
1.5 volt supply	1.5V	117	118	1.5V	1.5 volt supply
address 13	A13	119	120	ODT1	on die termination 1
Chip Select 1	S1#	121	122	N/C	reserved
1.5 volt supply	1.5V	123	124	1.5V	1.5 volt supply
reserved	(TEST)	125	126	REF-CA	reference current
ground	GND	127	128	GND	ground
data 32	DQ32	129	130	DQ36	data 36
data 33	DQ33	131	132	DQ37	data 37
ground	GND	133	134	GND	ground
data strobe 4 -	DQS4#	135	136	DQM4	data mask 4
data strobe 4 +	DQS4	137	138	GND	ground
ground	GND	139	140	DQ38	data 38
data 34	DQ34	141	142	DQ39	data 39
data 35	DQ35	143	144	GND	ground
ground	GND	145	146	DQ44	data 44
data 40	DQ40	147	148	DQ45	data 45
data 41	DQ41	149	150	GND	ground
ground	GND	151	152	DQS5#	data strobe 5 -
data mask 5	DQM5	153	154	DQS5	data strobe 5 +
ground	GND	155	156	GND	ground
data 42	DQ42	157	158	DQ46	data 46
data 43	DQ43	159	160	DQ47	data 47

Description	Name	Pin		Name	Description
ground	GND	161	162	GND	ground
data 48	DQ48	163	164	DQ52	data 52
data 49	DQ49	165	166	DQ53	data 53
ground	GND	167	168	GND	ground
data strobe 6 -	DQS6#	169	170	DQM6	data mask 6
data strobe 6	DQS6	171	172	GND	ground
ground	GND	173	174	DQ54	data 54
data 50	DQ50	175	176	DQ55	data 55
data 51	DQ51	177	178	GND	ground
ground	GND	179	180	DQ60	data 60
data 56	DQ56	181	182	DQ61	data 61
data 57	DQ57	183	184	GND	ground
ground	GND	185	186	DQS7#	data strobe 7 -
data mask 7	DQM7	187	188	DQS7	data strobe 7 +
ground	GND	189	190	GND	ground
data 58	DQ58	191	192	DQ62	data 62
data 59	DQ59	193	194	DQ63	data 63
ground	GND	195	196	GND	ground
SPD address 0	SA0	197	198	EVENT#	Event
3.3 volt supply	3.3V	199	200	SDA	SMBus data
SPD address 1	SA1	201	202	SCL	SMBus clock
termination current	VTT	203	204	VTT	termination current

### 3.6 VGA/DVI

The module is equipped with a standard DVI-I-connector, which can be used to connect a DVI capable device, a standard VGA monitor or an HDMI capable device. External cable adapters that convert from DVI to VGA or HDMI are required to connect standard VGA or HDMI devices.

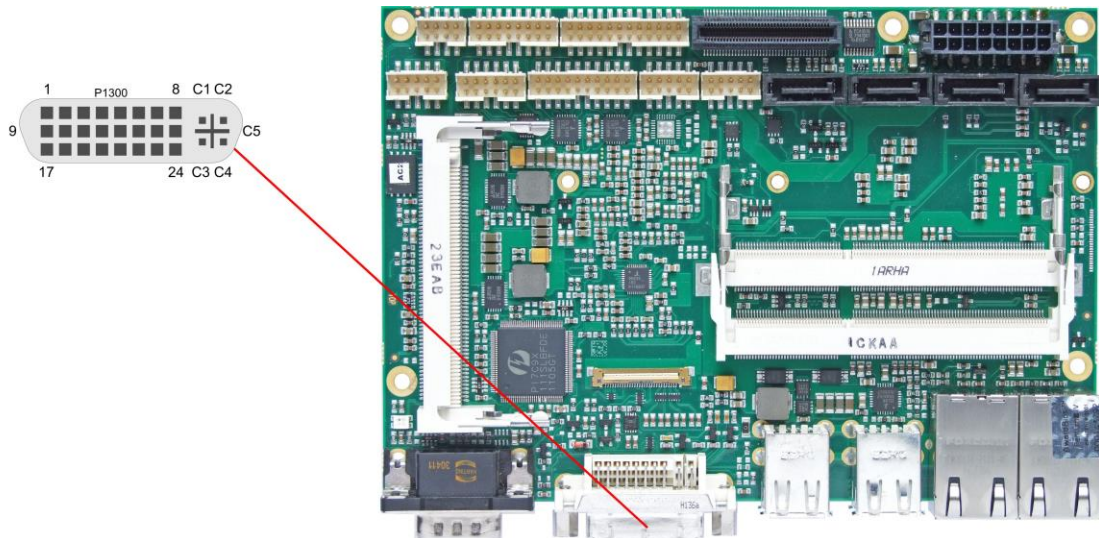

Pinout DVI-I:

Pin	Name	Description
1	TMDSDAT2#	DVI data 2 -
2	TMDSDAT2	DVI data 2 +
3	GND	ground
4	N/C	reserved
5	N/C	reserved
6	DDC CLK	DDC clock (DVI/VGA)
7	DDC DAT	DDC data (DVI/VGA)
8	VSYNC	VGA vertical sync
9	TMDSDAT1#	DVI data 1 -
10	TMDSDAT1	DVI data 1 +
11	GND	ground
12	N/C	reserved
13	N/C	reserved
14	VCC	5 volt supply
15	GND	ground
16	HP_DETECT	hot plug detect
17	TMDSDAT0#	DVI data 0 -
18	TMDSDAT0	DVI data 0 +
19	GND	ground
20	N/C	reserved
21	N/C	reserved
22	GND	ground
23	TMDS CLK	DVI clock
24	TMDS CLK#	DVI clock
C1	RED	VGA red
C2	GREEN	VGA green
C3	BLUE	VGA blue
C4	HSYNC	VGA horizontal sync

---

Pin	Name	Description
C5	GND	ground



### 3.7 DVI/HDMI/DisplayPort

The CB3056 provides a second DVI interface which is realized as a 30pin flat cable header (I-PEX Cabline-VS 20455-030E-12). Analog VGA is not available on this connector. However, an HDMI device or DisplayPort device can be connected. This custom connector also carries an additional USB interface. Please note that a custom cable design is required.

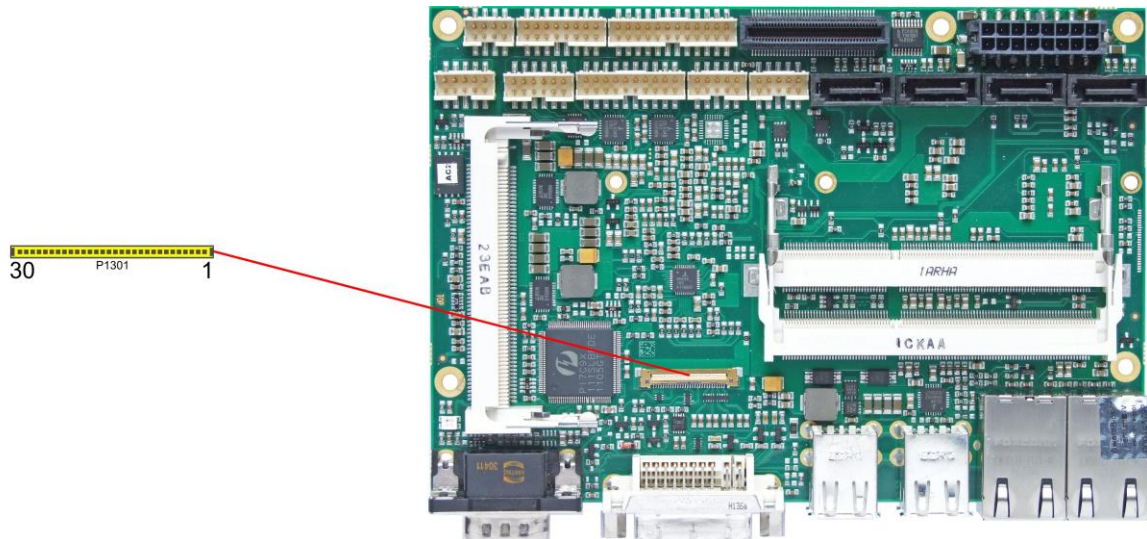

Pinout 30pin connector DVI/HDMI/DisplayPort:

Pin	Name	Description
1	TMDS0#/DP2#	DVI Data 0 - / DP Lane 2 -
2	TMDS0/DP2	DVI Data 0 + / DP Lane 2 +
3	TMDS1#/DP1#	DVI Data 1 - / DP Lane 1 -
4	TMDS1/DP1	DVI Data 1 + / DP Lane 1 +
5	TMDS2#/DP0#	DVI Data 2 - / DP Lane 0 -
6	TMDS2/DP0	DVI Data 2 + / DP Lane 0 +
7	TMDSCLK#/DP3#	DVI Clock - / DP Lane 3 -
8	TMDSCLK/DP3	DVI Clock + / DP Lane 3 +
9	N/C	reserved
10	SEL_DVI/DP#	DVI-DisplayPort Select
11	DDCK/DPAUX	EDID Clock / DP Aux +
12	DDDA/DPAUX#	EDID Data / DP Aux -
13	VCC	5V supply
14	GND	ground
15	HPD	hot plug detect
16	USBVCC	5V supply for USB
17	USBVCC	5V supply for USB
18	N/C	reserved
19	N/C	reserved
20	N/C	reserved
21	N/C	reserved
22	USB#	USB -
23	USB	USB +
24	N/C	reserved
25	N/C	reserved
26	3.3V	3.3V supply
27	3.3V	3.3V supply

Pin	Name	Description
28	VCC	5V supply
29	VCC	5V supply
30	VCC	5V supply

### 3.8 USB 1-4

The USB channels 1 to 4 are available as standard USB connectors. The USB channels support USB 2.0. You may note that the setting of USB keyboard or USB mouse support in the BIOS-setup is only necessary and advisable, if the OS offers no USB-support. BIOS-setup can be changed with a USB keyboard without enabling USB keyboard support. Running Windows with these features enabled may lead to significant performance or functionality limitations. Every USB interface provides up to 500 mA current and is protected by an electronically resettable fuse.

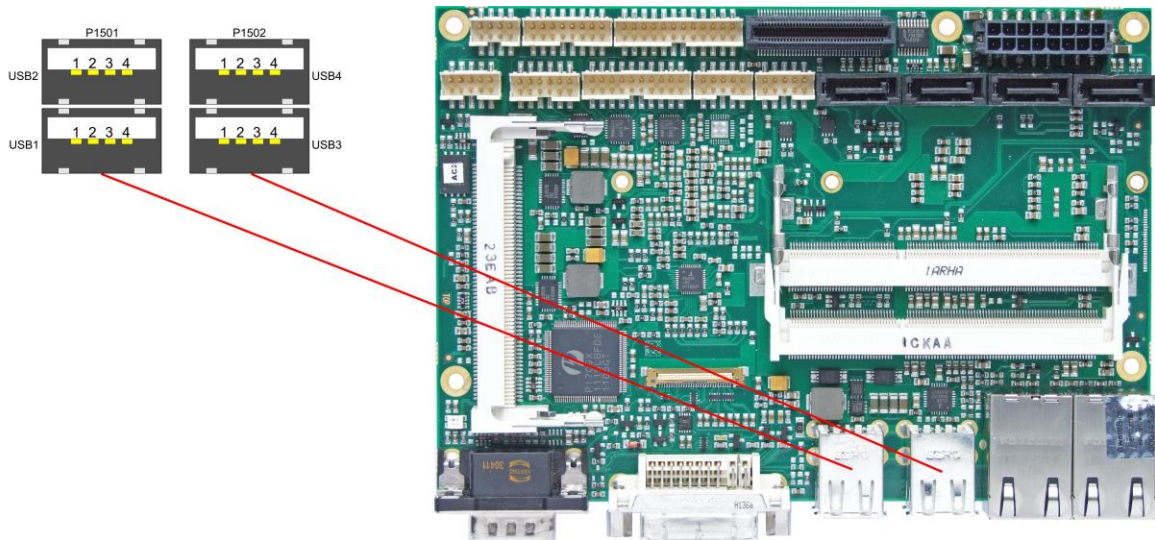

Pinout USB connector for channel X:

Pin	Name	Description
1	VCC	5 volt for USBX
2	USBX#	minus channel USBX
3	USBX	plus channel USBX
4	GND	ground

### 3.9 USB 5-10

The USB channels 5 to 10 are provided via two connectors, one of which is 2x4pin (FCI 98424-G52-08LF, mating connector FCI 90311-08LF), the other 2x8pin (FCI 98424-G52-16LF, mating connector FCI 90311-016LF).

The USB channels support USB 2.0. You may note that the setting of USB keyboard or USB mouse support in the BIOS-setup is only necessary and advisable, if the OS offers no USB-support. BIOS-setup can be changed with a USB keyboard without enabling USB keyboard support. Running Windows with these features enabled may lead to significant performance or functionality limitations.

Every USB interface provides up to 500 mA current and is protected by an electronically resettable fuse.

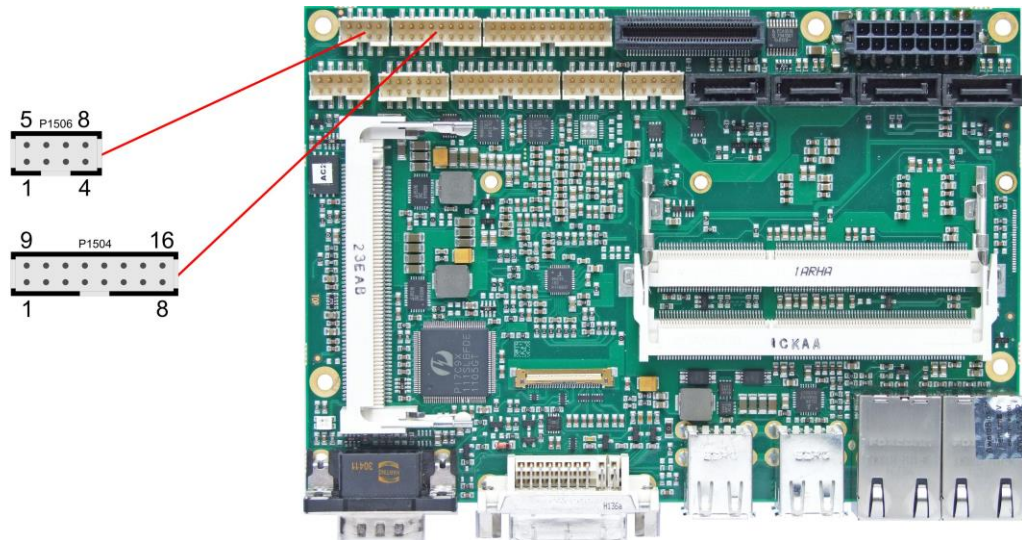

#### Pinout USB

Description	Name	Pin		Name	Description
5 volt for USB5	VCC	1	9	VCC	5 volt for USB6
minus channel USB5	USB5-	2	10	USB6-	minus channel USB6
plus channel USB5	USB5+	3	11	USB6+	plus channel USB6
ground	GND	4	12	GND	ground
ground	GND	5	13	GND	ground
plus channel USB7	USB7+	6	14	USB8+	plus channel USB8
minus channel USB7	USB7-	7	15	USB8-	minus channel USB8
5 volt for USB7	VCC	8	16	VCC	5 volt for USB8

#### Pinout USB 9/10

Description	Name	Pin		Name	Description
5 volt for USB9	VCC	1	5	VCC	5 volt for USB10
minus channel USB9	USB9-	2	6	USB10-	minus channel USB10
plus channel USB9	USB9+	3	7	USB10+	plus channel USB10
ground	GND	4	8	GND	ground

### 3.10 LAN

The module has two LAN interfaces both of which support 10BaseT, 100BaseT, and 1000BaseT compatible net components with automatic bandwidth selection. Controller chips are Intel® 82579L (PHY, LAN1) and 82574L (MAC/PHY, LAN2). Auto-cross and auto-negotiate functionality is available as is PXE, RPL and WOL.

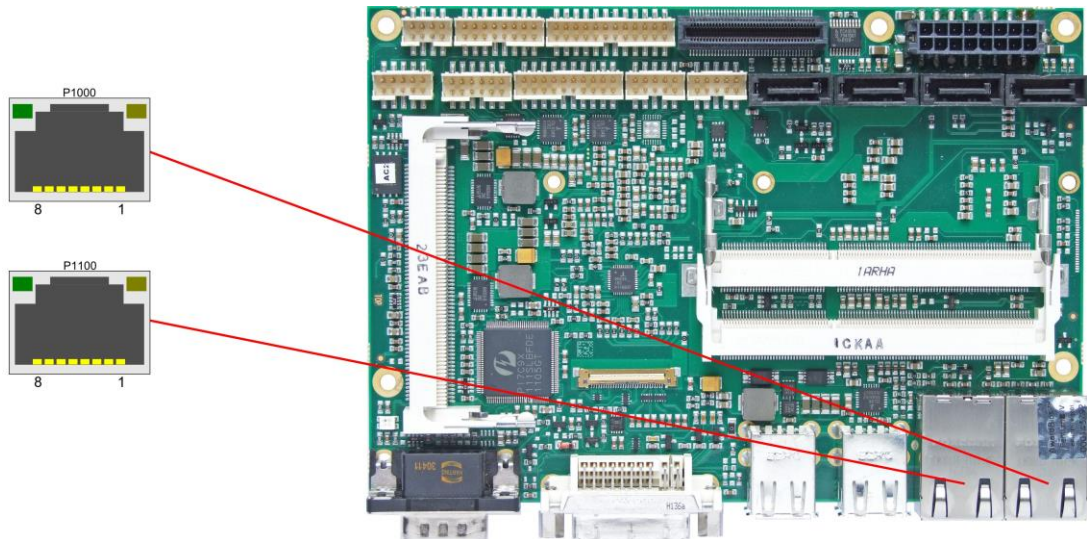

Pinout LAN 10/100/1000:

Pin	Name	Description
1	LAN-0	LAN channel 0 plus
2	LAN-0#	LAN channel 0 minus
3	LAN-1	LAN channel 1 plus
4	LAN-2	LAN channel 2 plus
5	LAN-2#	LAN channel 2 minus
6	LAN-1#	LAN channel 1 minus
7	LAN-3	LAN channel 3 plus
8	LAN-3#	LAN channel 3 minus

### 3.11 Audio

Audio input and output functions can be accessed via a 2x5 pin connector (FCI 98424-G52-10LF, mating connector FCI 90311-010LF). There are two ways to use this connector. Default functionality is the familiar audio in, audio out, and microphone. OS dependent device drivers can switch these signals to support a 5.1 output; thus in this mode no audio input signals are available.

Signals "SPDIFI" and "SPDIFO" provide digital input and output. If a transformation to a coaxial or optical connector is necessary this must be performed externally.

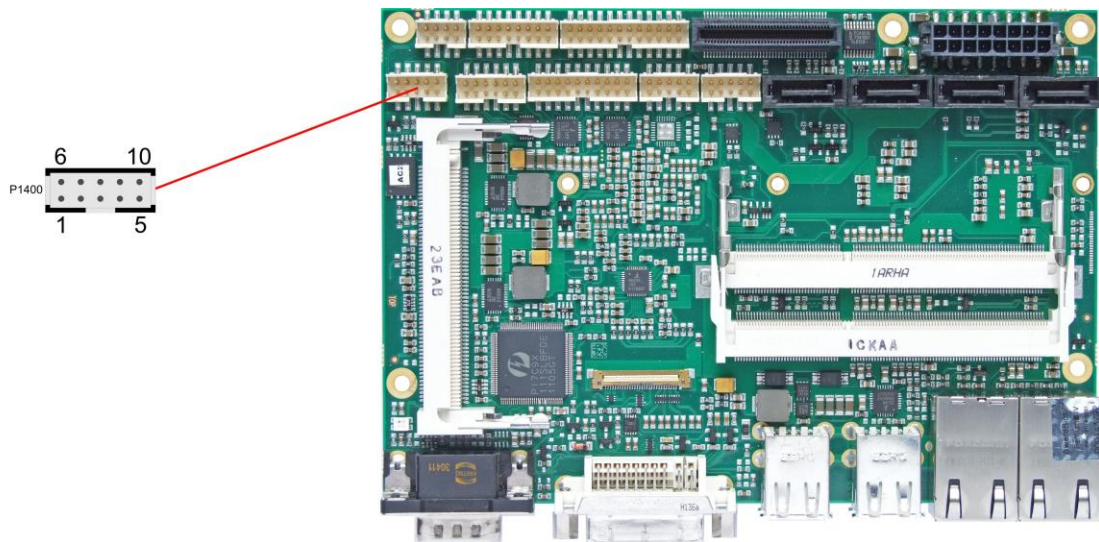

Pinout audio 2x5 pin connector:

Description	Name	Pin	Name	Description
digital output SPDIF	SPDIFO	1	6	3.3V
digital input SPDIF	SPDIFI	2	7	S_AGND
sound output right / front output right	LOUT_R / FRONT_R	3	8	LOUT_L / FRONT_L
AUX input right / rear output right	AUXA_R / REAR_R	4	9	AUXA_L / REAR_L
microphone input 1 / center output	MIC1 / CENTER	5	10	MIC2 / LFE
				3.3 volt supply
				analog ground sound
				sound output left / front output left
				AUX input left / rear output left
				microphone input 2 / LFE output

### 3.12 SATA Interfaces

The CB3056 provides four SATA interfaces from which SATA 3 and 4 allow transfer rates of up to 3 Gb/s. Additionally SATA 1 and 2 allow transfer rates up to 6 Gb/s. All these interfaces are made available via a 7pin connector and support RAID 0/1/5/10.

The required settings are made in the BIOS setup.

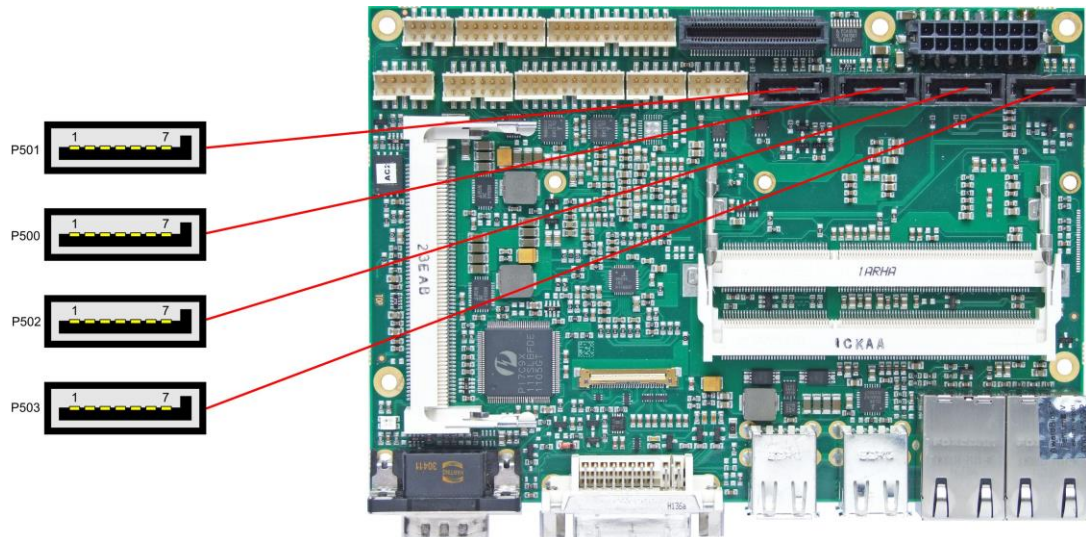

Pinout SATA:

Pin	Name	Description
1	GND	ground
2	SATATX	SATA transmit +
3	SATATX#	SATA transmit -
4	GND	ground
5	SATARX	SATA receive -
6	SATARX#	SATA receive +
7	GND	ground

### 3.13 Serial Interface COM1

The serial interface COM1 is made available via a 9-pin standard DSUB-connector (male, e.g. Foxconn DM10152-H5W3-4F). Signal level is RS232.

The port address and the interrupt are set via the BIOS setup.

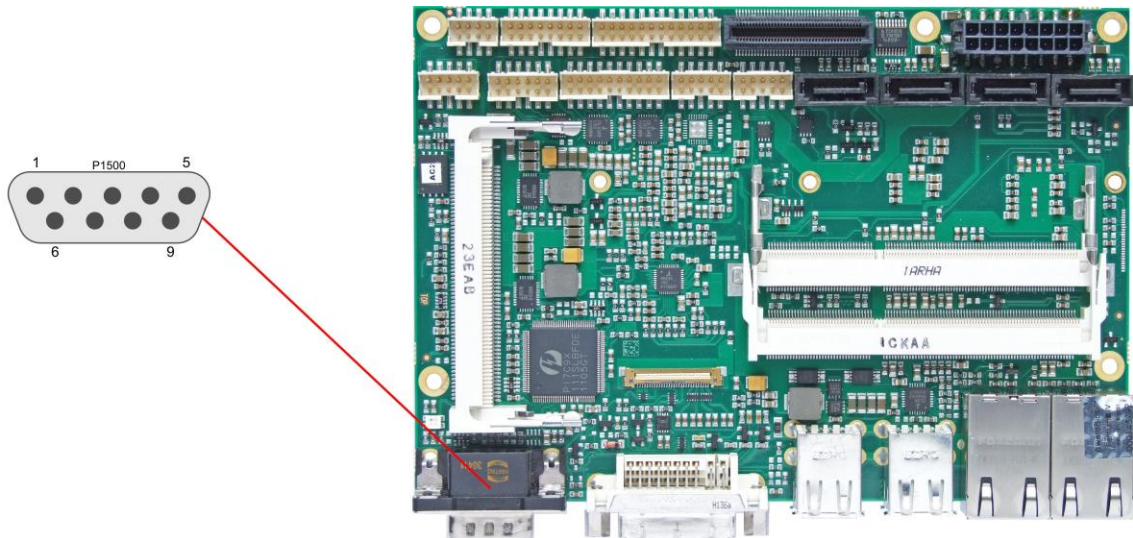

Pinout serial port (DSUB connector):

Description	Name	Pin	Name	Description	
data carrier detect	DCD	1	6	DSR	data set ready
receive data	RXD	2	7	RTS	request to send
transmit data	TXD	3	8	CTS	clear to send
data terminal ready	DTR	4	9	RI	ring indicator
ground	GND	5			



### 3.14 Serial Ports COM2 through COM4

There are three more serial interfaces on the board. Of these, COM3 is available through the power connector (cf. p. 18), or, as an option, through a 2x5pin connector (FCI 98424-G52-10LF). COM2 and COM4 and made available via a 2x10 pin connector (FCI 98424-G52-20LF). Signal level is RS232. The port address and the interrupt are set via the BIOS setup.

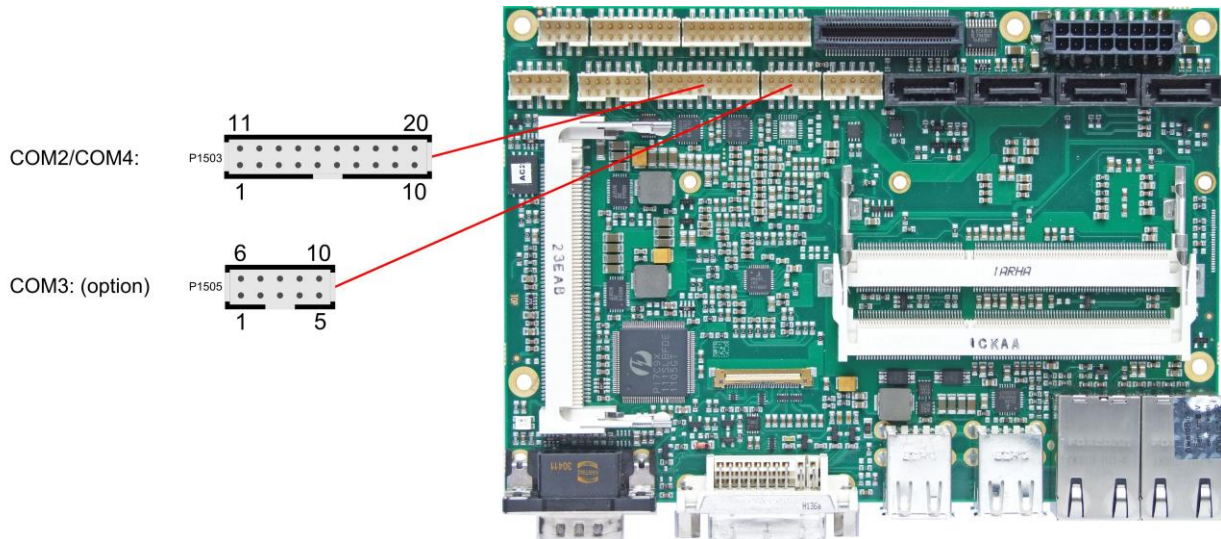

Description	Name	Pin	Name	Description
data carrier detect COM2	DCDB	1	DSRB	data set ready COM2
receive data COM2	RXDB	2	RTSB	request to send COM2
transmit data COM2	TXDB	3	CTSB	clear to send COM2
data terminal ready COM2	DTRB	4	RIB	ring indicator COM2
ground	GND	5	SVCC	5 volt supply
data carrier detect COM4	DCDD	6	DSRD	data set ready COM4
receive data COM4	RXDD	7	RTSD	request to send COM4
transmit data COM4	TXDD	8	CTSD	clear to send COM4
data terminal ready COM4	DTRD	9	RID	ring indicator COM4
ground	GND	10	SVCC	5 volt supply

When the module is ordered in standard configuration, the 2x5pin connector offers mouse and keyboard signals.

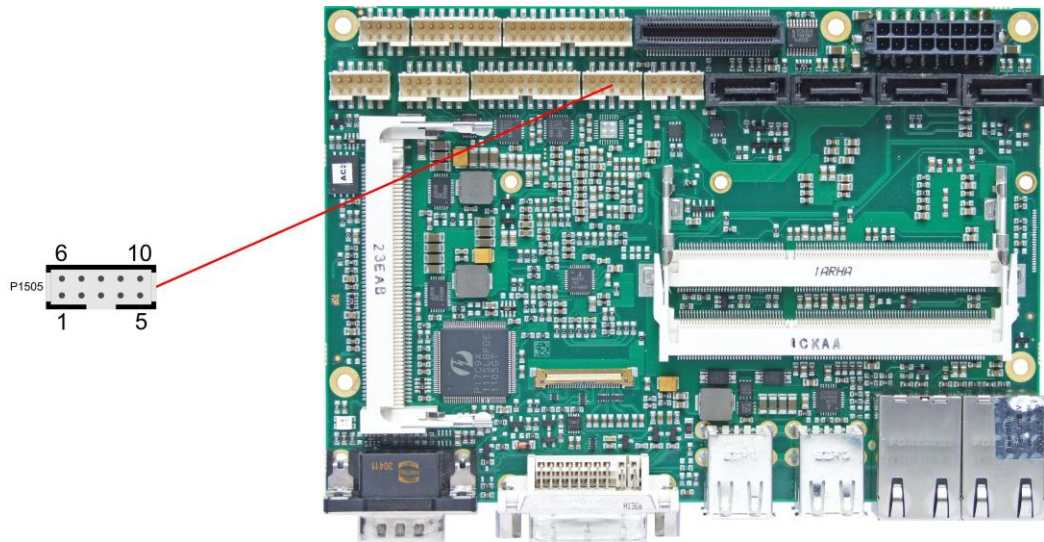

Alternative pinout of COM-connector:

Description	Name	Pin		Name	Description
keyboard clock	KCLK	1	6	MCLK	mouse clock
keyboard data	KDAT	2	7	MDAT	mouse data
reserved	N/C	3	8	N/C	reserved
reserved	N/C	4	9	N/C	reserved
ground	GND	5	10	3.3V	3.3 volt supply

### 3.15 PCI-Express

The CB3056 offers a 2x40pin custom connector for the PCI-Express bus. You can connect one PCIe4x device here. Alternatively, up to four PCIe1x devices can be connected. Adapter cards featuring standard PCIe sockets or a PCIe Mini Card connector are available. Please contact your sales representative for these cards.

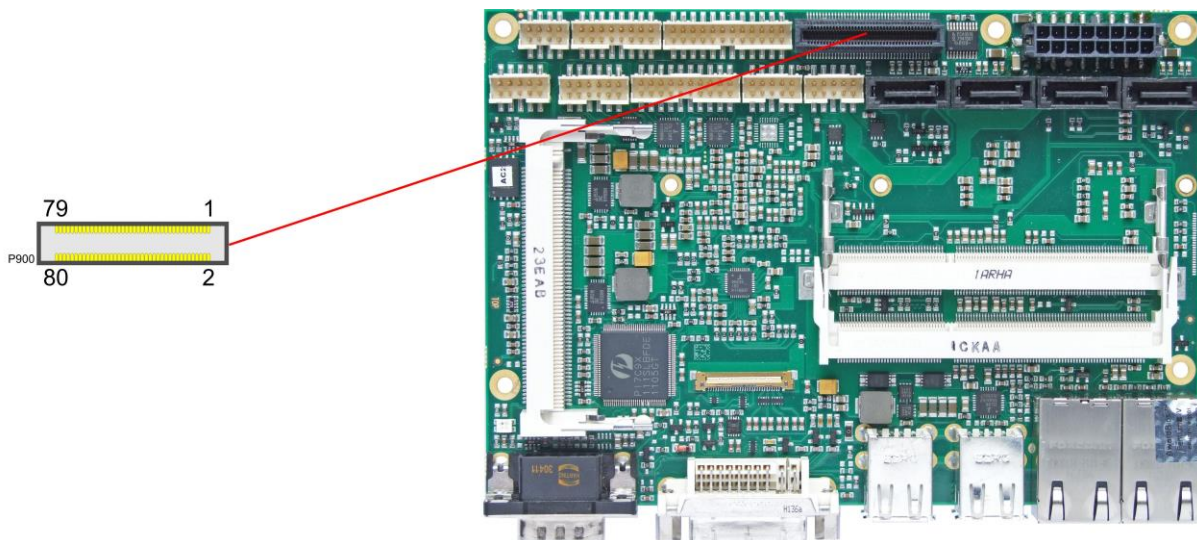

Pinout 2x40 pin connector PCIe:

Description	Name	Pin	Name	Description
3.3 volt supply	3.3V	1	2	12V
3.3 volt stand-by	S3.3V	3	4	SMBCLK1
PCIe reset	PLTPCIE#	5	6	SMBDAT1
link reactivation	PEWAKE#	7	8	GND
ground	GND	9	10	PECLK0
transmit lane 1 +	PET1	11	12	PECLK0#
transmit lane 1 -	PET1#	13	14	GND
ground	GND	15	16	PER1
clock enable 1	PE1CLKEN#	17	18	PER1#
ground	GND	19	20	GND
3.3 volt supply	3.3V	21	22	12V
3.3 volt stand-by	S3.3V	23	24	SMBCLK2
PCIe reset	PLTPCIE#	25	26	SMBDAT2
link reactivation	PEWAKE#	27	28	GND
ground	GND	29	30	PECLK1
transmit lane 2 +	PET2	31	32	PECLK1#
transmit lane 2 -	PET2#	33	34	GND
ground	GND	35	36	PER2
clock enable 2	PE2CLKEN#	37	38	PER2#
ground	GND	39	40	GND
3.3 volt supply	3.3V	41	42	12V
3.3 volt stand-by	S3.3V	43	44	SMBCLK3
PCIe reset	PLTPCIE#	45	46	SMBDAT4
link reactivation	PEWAKE#	47	48	GND
ground	GND	49	50	PECLK2
transmit lane 3 +	PET3	51	52	PECLK2#
transmit lane 3 -	PET3#	53	54	GND

Description	Name	Pin		Name	Description
ground	GND	55	56	PER3	receive lane 3 +
clock enable 3	PE3CLKEN#	57	58	PER3#	receive lane 3 -
ground	GND	59	60	GND	ground
3.3 volt supply	3.3V	61	62	12V	12 volt supply
3.3 volt stand-by	S3.3V	63	64	SMBCLK4	SMB clock slot 4
PCIe reset	PLTPCIE#	65	66	SMBDAT4	SMB dat slot 4
link reactivation	PEWAKE#	67	68	GND	ground
ground	GND	69	70	PECLK3	PCIe clock 3 +
transmit lane 4 +	PET4	71	72	PECLK3#	PCIe clock 3 -
transmit lane 4 -	PET4#	73	74	GND	ground
ground	GND	75	76	PER4	receive lane 4 +
clock enable 4	PE3CLKEN#	77	78	PER4#	receive lane 4 -
PCIe configure x1/x4	PECONF#	79	80	GND	ground

### 3.16 Mini-PCI

The CB3056 allows you to add expansion cards complying to the Mini-PCI standard (type III). One such card can be inserted into the Mini-PCI slot available on the board.

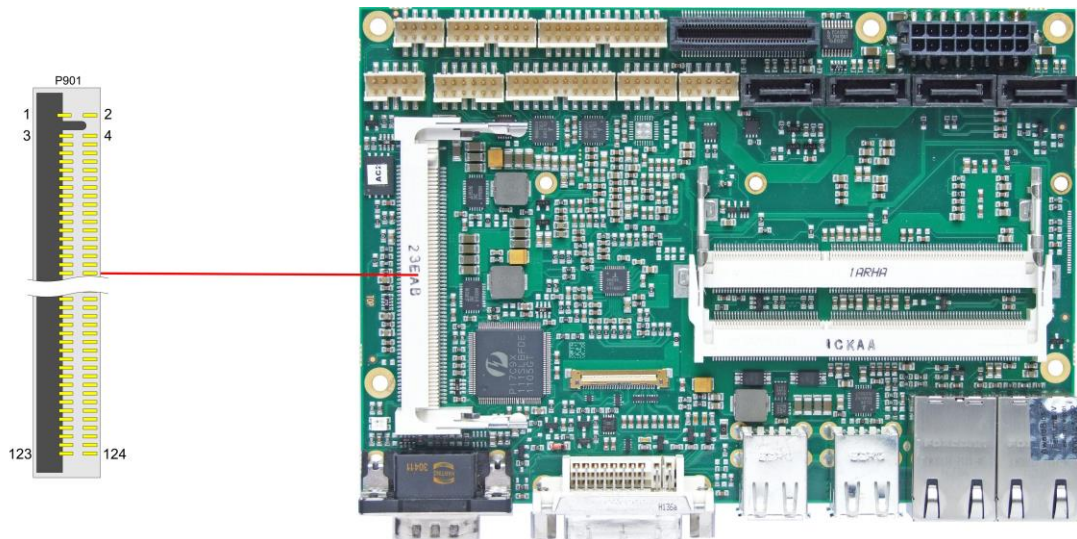

Description	Name	Pin	Pin	Name	Description
reserved	N/C	1	2	N/C	reserved
reserved	N/C	3	4	N/C	reserved
reserved	N/C	5	6	N/C	reserved
reserved	N/C	7	8	N/C	reserved
reserved	N/C	9	10	N/C	reserved
reserved	N/C	11	12	N/C	reserved
reserved	N/C	13	14	N/C	reserved
reserved	N/C	15	16	N/C	reserved
interrupt B	INTB#	17	18	VCC	5 volt supply
3.3 volt supply	3.3V	19	20	INTA#	interrupt A
serial interrupt (legacy)	SERIRQ	21	22	N/C	reserved
ground	GND	23	24	S3.3V	3.3 volt supply
PCI clock	PCLK	25	26	PRST#	reset
ground	GND	27	28	3.3V	3.3 volt supply
PCI request	REQ#	29	30	GNT#	PCI grant
3.3 volt supply	3.3V	31	32	GND	ground
address/data 31	AD31	33	34	PME#	power management event
address/data 29	AD29	35	36	N/C	reserved
ground	GND	37	38	AD30	address/data 30
address/data 27	AD27	39	40	3.3V	3.3 volt supply
address/data 25	AD25	41	42	AD28	address/data 28
interrupt C	INTC#	43	44	AD26	address/data 26
bus cmd/byte enables 3	CBE3#	45	46	AD24	address/data 24
address/data 23	AD23	47	48	IDSEL	init device select
ground	GND	49	50	GND	ground
address/data 21	AD21	51	52	AD22	address/data 22
address/data 19	AD19	53	54	AD20	address/data 20
ground	GND	55	56	PAR	parity
address/data 17	AD17	57	58	AD18	address/data 18

Description	Name	Pin		Name	Description
bus cmd/byte enables 2	CBE2#	59	60	AD16	address/data 16
initiator ready	IRDY#	61	62	GND	ground
3.3 volt supply	3.3V	63	64	FRAME#	cycle frame
clock running	CLKRUN#	65	66	TRDY#	target ready
system error	SERR#	67	68	STOP#	stop request by target
ground	GND	69	70	3.3V	3.3 volt supply
parity error	PERR#	71	72	DEVSEL#	device select
bus cmd/byte enables 1	CBE1#	73	74	GND	ground
address/data 14	AD14	75	76	AD15	address/data 15
ground	GND	77	78	AD13	address/data 13
address/data 12	AD12	79	80	AD11	address/data 11
address/data 10	AD10	81	82	GND	ground
ground	GND	83	84	AD9	address/data 9
address/data 8	AD8	85	86	CBE0#	bus cmd/byte enables 0
address/data 7	AD7	87	88	3.3V	3.3 volt supply
3.3 volt supply	3.3V	89	90	AD6	address/data 6
address/data 5	AD5	91	92	AD4	address/data 4
interrupt D	INTD#	93	94	AD2	address/data 2
address/data 3	AD3	95	96	AD0	address/data 0
5 volt supply	VCC	97	98	N/C	reserved
address/data 1	AD1	99	100	N/C	reserved
ground	GND	101	102	GND	ground
reserved	N/C	103	104	GND	ground
reserved	N/C	105	106	N/C	reserved
reserved	N/C	107	108	N/C	reserved
reserved	N/C	109	110	N/C	reserved
reserved	N/C	111	112	N/C	reserved
reserved	N/C	113	114	GND	ground
reserved	N/C	115	116	N/C	reserved
reserved	N/C	117	118	N/C	reserved
reserved	N/C	119	120	N/C	reserved
lock	PLOCK#	121	122	N/C	reserved
reserved	N/C	123	124	S3.3V	3.3 volt supply

### 3.17 GPIO

The General Purpose Input/Output interface is made available through a 2x6 pin connector (FCI 98424-G52-12LF, mating connector FCI 90311-012LF). To make use of this interface the GPIO chip (PCA9535BS) must be programmed accordingly. Please refer to your distributor for information on available software support.

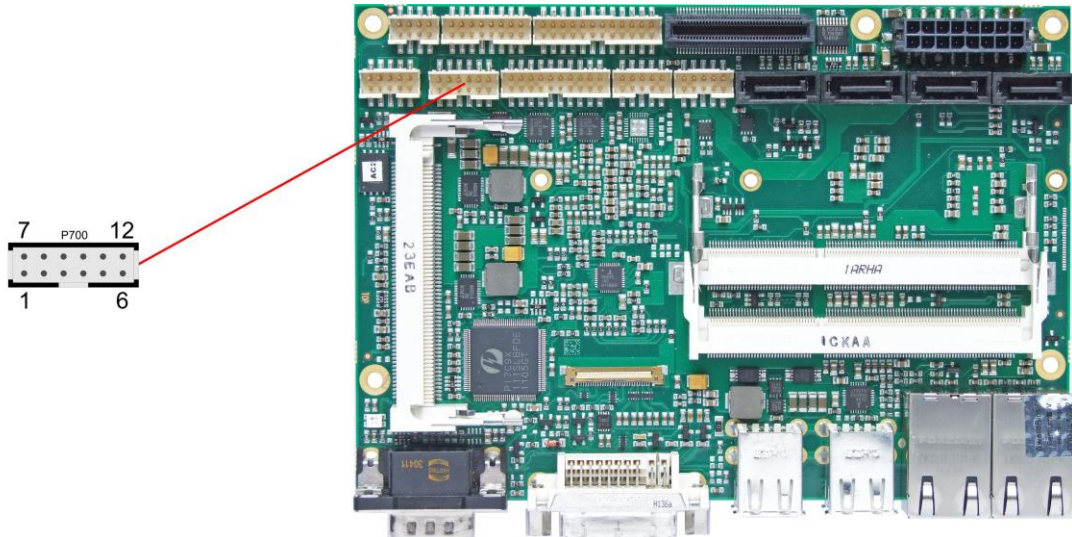

Pinout GPIO connector:

Description	Name	Pin	Name	Description
5 volt supply	VCC	1	7	VCC
GP input/output 10	GPIO10	2	8	GPIO14
GP input/output 11	GPIO11	3	9	GPIO15
GP input/output 12	GPIO12	4	10	GPIO16
GP input/output 13	GPIO13	5	11	GPIO17
ground	GND	6	12	GND

### 3.18 Fan Connectors

Three external fans (12V) can be connected to the board using a 2x5pin connector (FCI 98424-G52-10LF, mating connector FCI 90311-010LF). Monitoring signals are available. For the monitoring to work the fans must provide a corresponding speed signal.

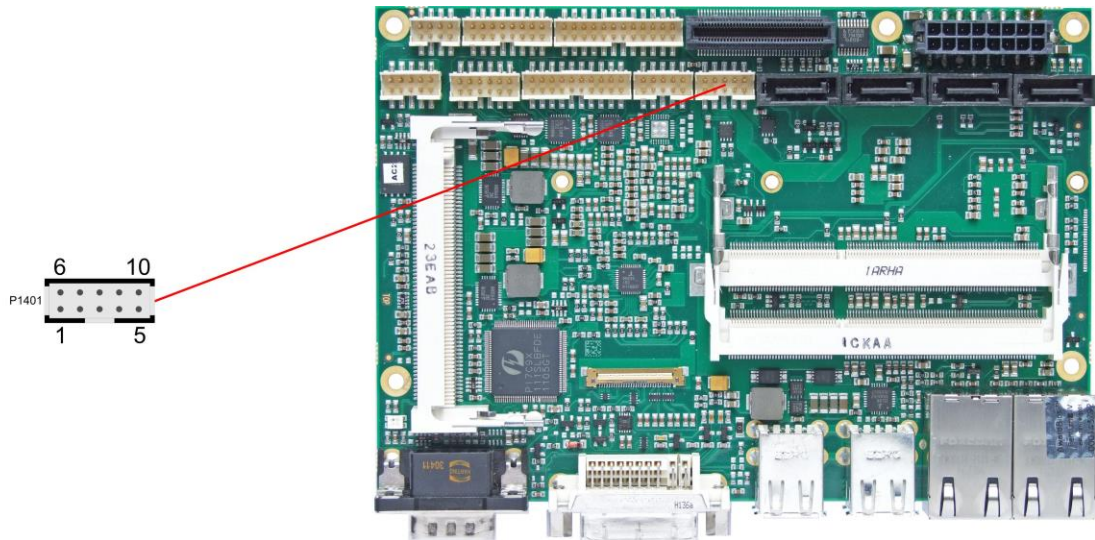

Description	Name	Pin	Name	Description	
ground regulated	FANON1	1	6	FANON2	ground regulated
12V supply	12V	2	7	12V	12V supply
Fan 1 monitoring signal	FANCTRL1	3	8	FANCTRL2	Fan 2 monitoring signal
12V supply	12V	4	9	FANCTRL3	Fan 3 monitoring signal
ground regulated	FANON3	5	10	GND	ground



## 4 BIOS Settings

### 4.1 General Remarks

In each setup page, standard values for all setup entries can be loaded. Previously saved settings are loaded by pressing F2 and factory defaults are loaded with F3. Both F2 and F3, and also F4 ("Save & Exit") always affect the whole set of setup entries.

Setup entries starting with a „▶" sign represent submenus. Navigation between entries is done using the arrow keys on the keyboard, with the <Enter> key being used to select an entry, which either opens up a dialog box or opens a whole new submenu of setup entries.

Each setup entry has a short help text associated with it. This is displayed in the upper right hand corner of the screen.



#### **NOTE**

BIOS features and setup options are subject to change without notice. The settings displayed in the screenshots on the following pages are meant to be examples only. They do not represent the recommended settings or the default settings. Determination of the appropriate settings is dependent upon the particular application scenario in which the board is used.

## 4.2 Main

Aptio Setup Utility - Copyright (C) 2012 American Megatrends, Inc.  
 MAIN Advanced Chipset Boot Security Save & Exit

<pre> Board Information Board                CB3056 Revision             3 Bios Version         1.37  Processor Information Name                 SandyBridge Brand String         Intel(R) Celeron(R) CPU Frequency            1400 MHz Processor ID         206a7 Stepping             D2 Number of Processors 1Core(s) / 1Thread(s) Microcode Revision   28 GT Info              GT1 (800 MHz)  IGFX VBIOS Version   2165 Memory RC Version    1.2.2.0 Total Memory         4096 MB (DDR3) Memory Frequency     1333 Mhz  System Date          [Mon 27/02/2014] System Time          [00:47:04] </pre>	<pre> Set the Date. Use Tab to switch between Data elements.  ----- ←: Select Screen ↑↓: Select Item Enter: Select +/-: Change Opt. F1: General Help F2: Previous Values F3: Optimized Defaults F4: Save &amp; Exit ESC: Exit </pre>
--	--

Version 2.15.1236. Copyright (C) 2012 American Megatrends, Inc.

- ✓ **Board**  
Options: none
- ✓ **Revision**  
Options: none
- ✓ **Bios Version**  
Options: none
- ✓ **Processor Information**  
Options: none
- ✓ **Name**  
Options: none
- ✓ **Brand String**  
Options: none
- ✓ **Frequency**  
Options: none
- ✓ **Processor ID**  
Options: none
- ✓ **Stepping**  
Options: none
- ✓ **Number of Processors**  
Options: none
- ✓ **Microcode Revision**  
Options: none

- ✓ **GT Info**  
Options: none
- ✓ **IGFX VBIOS Version**  
Options: none
- ✓ **Memory RC Version**  
Options: none
- ✓ **Total Memory**  
Options: none
- ✓ **Memory Frequency**  
Options: none
- ✓ **System Date**  
Options: The system date can be adjusted here.
- ✓ **System Time**  
Options: The system time can be adjusted here.

## 4.3 Advanced

Aptio Setup Utility - Copyright (C) 2012 American Megatrends, Inc.  
Main ADVANCED Chipset Boot Security Save & Exit

<pre> Power-Supply Type                [ATX] SoftOff on Overheat              [Disabled] ▶ PCI Subsystem Settings ▶ ACPI Settingstion ▶ CPU Configuration ▶ SATA Configuration ▶ Power Controller Options ▶ USB Configuration ▶ Super IO Configuration ▶ H/W Monitor ▶ Serial Port Console Redirection ▶ Network Stack ▶ CPU PPM Configuration  ▶ Intel(R) 82579LM Gigabit Network Connection - 00:01:05:1... ▶ Intel(R) 82574L Gigabit Network Connection - 00:01:05:11... </pre>	<pre> Select the Type of the Power Supply: AT/ATX  ---: Select Screen ↑↓: Select Item Enter: Select +/-: Change Opt. F1: General Help F2: Previous Values F3: Optimized Defaults F4: Save &amp; Exit ESC: Exit </pre>
--	---

Version 2.15.1236. Copyright (C) 2012 American Megatrends, Inc.

- ✓ **Power-Supply Type**  
Options: ATX / AT
- ✓ **SoftOff on Overheat**  
Options: Disabled / Enabled
- ✓ **PCI Subsystem Settings**  
Sub menu: see "PCI Subsystem Settings" (page 46)
- ✓ **ACPI Settings**  
Sub menu: see "ACPI Settings" (page 48)
- ✓ **CPU Configuration**  
Sub menu: see "CPU Configuration" (page 49)
- ✓ **SATA Configuration**  
Sub menu: see "SATA Configuration" (page 51)
- ✓ **Power Controller Options**  
Sub menu: see "Power Controller Options" (page 52)
- ✓ **USB Configuration**  
Sub menu: see "USB Configuration" (page 54)
- ✓ **Super IO Configuration**  
Sub menu: see "Super IO Configuration" (page 55)
- ✓ **H/W Monitor**  
Sub menu: see "H/W Monitor" (page 57)
- ✓ **Serial Port Console Redirection**  
Sub menu: see "Serial Port Console Redirection" (page 59)

- ✓ **Network Stack**  
Sub menu: see "Network Stack" (page 61)
- ✓ **CPU PPM Configuration**  
Sub menu: see "CPU PPM Configuration" (page 62)
- ✓ **Intel(R) Gigabit Network Connection**  
Sub menu: see "Intel(R) GigabitNetworkConnection" (page 63)

### 4.3.1 PCI Subsystem Settings

Aptio Setup Utility - Copyright (C) 2012 American Megatrends, Inc.  
Advanced

PCI Bus Driver Version	V 2.05.02	Enables or Disables 64bit capable Devices to be Decoded in Above 4G Address Space (Only if System Supports 64 bit PCI Decoding).
PCI 64bit Resources Handling Above 4G Decoding	[Disabled]	
PCI Common Settings		←: Select Screen ↑↓: Select Item Enter: Select +/-: Change Opt. F1: General Help F2: Previous Values F3: Optimized Defaults F4: Save & Exit ESC: Exit
PCI Latency Timer	[32 PCI Bus Clocks]	
▶ PCI Express Settings		

Version 2.15.1236. Copyright (C) 2012 American Megatrends, Inc.

- ✓ **Above 4G Decoding**  
Options: Enabled / Disabled
- ✓ **PCI Latency Timer**  
Options: 32, 64,...224, 248 PCI Bus Clocks
- ✓ **PCI Express Settings**  
Sub menu: see "PCI Express Settings" (page 47)



## 4.3.2 ACPI Settings

Aptio Setup Utility - Copyright (C) 2012 American Megatrends, Inc.  
Advanced

ACPI Settings		Enables or Disables BIOS ACPI Auto Configuration.
Enable ACPI Auto Configuration	[Disabled]	
Enable Hibernation	[Enabled]	
ACPI Sleep State	[S1 only(CPU Stop Cl...)]	
Lock Legacy Resources	[Disabled]	
		←: Select Screen ↑↓: Select Item Enter: Select +/-: Change Opt. F1: General Help F2: Previous Values F3: Optimized Defaults F4: Save & Exit ESC: Exit

Version 2.15.1236. Copyright (C) 2012 American Megatrends, Inc.

- ✓ **Enable ACPI Auto Configuration**  
Options: Enabled / Disabled
- ✓ **Enable Hibernation**  
Options: Enabled / Disabled
- ✓ **ACPI Sleep State**  
Options: Suspend Disabled / S1 (CPU Stop Clock)
- ✓ **Lock Legacy Resources**  
Options: Enabled / Disabled



### 4.3.3 CPU Configuration

Aptio Setup Utility - Copyright (C) 2012 American Megatrends, Inc.  
Advanced

<pre> CPU Configuration Intel(R) Celeron(R) CPU 827E @ 1.4GHz CPU Signature                206a7 Microcode Patch              28 Max CPU Speed                 1400 MHz Min CPU Speed                 800 MHz CPU Speed                     1400 MHz Processor Cores               1 Intel HT Technology           Not Supported Intel VT-x Technology         Supported Intel SMX Technology          Not Supported 64-bit                        Supported  L1 Data Cache                 32 kB x 1 L1 Code Cache                 32 kB x 1 L2 Cache                      256 kB x 1 L3 Cache                      1536 kB  Hyperthreading                [Enabled] Active Processor Cores        [All] Limit CPUID Maximum           [Disabled] Execute Disable Bit           [Enabled] Intel Virtualization Technology [Disabled] TCC Activation offset         0 Primary Plane Current value   0 Secondary Plane Current value 0                 </pre>	<p>Disabled for Windows XP</p> <hr/> <pre> ←: Select Screen ↑: Select Item Enter: Select +/-: Change Opt. F1: General Help F2: Previous Values F3: Optimized Defaults F4: Save &amp; Exit ESC: Exit                 </pre>
--	--

Version 2.15.1236. Copyright (C) 2012 American Megatrends, Inc.

- ✓ **CPU Signature**  
Options: none
- ✓ **Microcode Patch**  
Options: none
- ✓ **Max CPU Speed**  
Options: none
- ✓ **Min CPU Speed**  
Options: none
- ✓ **CPU Speed**  
Options: none
- ✓ **Processor Cores**  
Options: none
- ✓ **Intel HT Technology**  
Options: none
- ✓ **Intel VT-x Technology**  
Options: none
- ✓ **Intel SMX Technology**  
Options: none
- ✓ **64-bit**  
Options: none
- ✓ **L1 Data Cache**  
Options: none

- ✓ **L1 Code Cache**  
Options: none
- ✓ **L2 Cache**  
Options: none
- ✓ **L3 Cache**  
Options: none
- ✓ **Hyper-threading**  
Options: Disabled / Enabled
- ✓ **Active Processor Cores**  
Options: All
- ✓ **Limit CPUID Maximum**  
Options: Enabled / Disabled
- ✓ **Execute Disable Bit**  
Options: Enabled / Disabled
- ✓ **Intel Virtualization Technology**  
Options: Enabled / Disabled
- ✓ **TCC Activation Offset**  
Options: 0...15
- ✓ **Primary Plane Current value**  
Options: 0...255
- ✓ **Secondary Plane Current value**  
Options: 0...255

### 4.3.4 SATA Configuration

Aptio Setup Utility - Copyright (C) 2012 American Megatrends, Inc.  
Advanced

SATA Controller(s)	[Enabled]	▲ Enable or disable SATA Device.
SATA Mode Selection	[RAID]	
SATA Test Mode	[Disabled]	
Alternate ID	[Disabled]	
Serial ATA Port 0	Empty	▼
Software Preserve	Unknown	
Port 0	[Enabled]	
Hot Plug	[Enabled]	
Spin Up Device	[Disabled]	
Serial ATA Port 1	Empty	
Software Preserve	Unknown	
Port 1	[Enabled]	
Hot Plug	[Enabled]	
Spin Up Device	[Disabled]	
Serial ATA Port 2	Empty	
Software Preserve	Unknown	
Port 2	[Enabled]	
Hot Plug	[Disabled]	
External SATA	[Disabled]	
Hot Plug	[Enabled]	
Spin Up Device	[Disabled] Drive]	
Serial ATA Port 3	Empty	
Software Preserve	Unknown	
Port 3	[Enabled]	
Hot Plug	[Enabled]	
External SATA	[Disabled]	

Version 2.15.1236. Copyright (C) 2012 American Megatrends, Inc.

- ✓ **SATA Controller(s)**  
Options: Enabled / Disabled
- ✓ **SATA Mode Selection**  
Options: IDE / AHCI / RAID
- ✓ **SATA Test Mode**  
Options: Enabled / Disabled
- ✓ **Alternate ID**  
Options: Enabled / Disabled
- ✓ **Serial ATA Port X**  
Options: none
- ✓ **Software Preserve**  
Options: none
- ✓ **Port X**  
Options: Enabled / Disabled
- ✓ **Hot Plug**  
Options: Enabled / Disabled
- ✓ **External SATA**  
Options: Enabled / Disabled
- ✓ **Spin Up Device**  
Options: Enabled / Disabled

### 4.3.5 Power Controller Options

Aptio Setup Utility - Copyright (C) 2012 American Megatrends, Inc.  
Advanced

Bootloader Version	1.00-07	Select Power line for external USB devices, if powered-down
Firmware Version	1.00-35	
Mainboard Serial No	0948251130007	
Mainboard Prod. Date (Week.Year)	28.12	
Mainboard BootCount	128	
Mainboard Operation Time	12090min (201h)	
Voltage (Min/Max)	4.60V / 5.20V	
Temperature (Min/Max)	18'C /51'C	
ext. USB-Port Voltage	[Off in S3-5]	
int. USB-Port Voltage	[Off in S3-5]	
WatchDogTimer Mode	[Normal Mode]	
WDT OSBOOT Timeout	[Disabled]	

Version 2.15.1236. Copyright (C) 2012 American Megatrends, Inc.

- ✓ **Bootloader Version**  
Options: none
- ✓ **Firmware Version**  
Options: none
- ✓ **Mainboard Serial No**  
Options: none
- ✓ **Mainboard Prod. Date (Week.Year)**  
Options: none
- ✓ **Boot Count**  
Options: none
- ✓ **Minute Meter**  
Options: none
- ✓ **Voltage (Min/Max)**  
Options: none
- ✓ **Temperature (Min/Max)**  
Options: none
- ✓ **ext. USB-Port Voltage**  
Options: Off in S3-5 / by SVCC
- ✓ **int. USB-Port Voltage**  
Options: Off in S3-5 / by SVCC
- ✓ **WatchDogTimer Mode**  
Options: Normal Mode / Compatibility Mode

✓ **WDT OSBoot Timeout**

Options: Disabled / 45 Seconds ... 255 Seconds

### 4.3.6 USB Configuration

Aptio Setup Utility - Copyright (C) 2012 American Megatrends, Inc.  
Advanced

<pre> USB Configuration USB Devices:   1 Drive, 1 Keyboard, 1 Mouse  Legacy USB Support          [Auto] USB3.0 Support              [Enabled] XHCI Hand-off               [Enabled] EHCI Hand-off               [Enabled]  USB hardware delays and time-outs: USB transfer time-out       [5 sec] Device reset time-out       [10 sec] Device power-up delay       [Manual] Device power-up delay in seconds  5 </pre>	<pre> Enables Legacy USB support. AUTO option disables legacy support if no USB devices are connected. DISABLE option will keep USB devices available only for EFI applications.  ←: Select Screen ↑↓: Select Item Enter: Select +/-: Change Opt. F1: General Help F2: Previous Values F3: Optimized Defaults F4: Save &amp; Exit ESC: Exit </pre>
--	--

Version 2.15.1236. Copyright (C) 2012 American Megatrends, Inc.

- ✓ **USB Devices**  
Options: none
- ✓ **Legacy USB Support**  
Options: Enabled / Disabled / Auto
- ✓ **USB3.0 Support**  
Options: Enabled / Disabled
- ✓ **XHCI Hand-off**  
Options: Enabled / Disabled
- ✓ **EHCI Hand-off**  
Options: Enabled / Disabled
- ✓ **USB transfer time-out**  
Options: 5 sec / 10 sec / 20 sec
- ✓ **Device reset time-out**  
Options: 10 sec / 20 sec / 30 sec / 40 sec
- ✓ **Device power-up delay**  
Options: Auto / Manual
- ✓ **Device power-up delay in seconds**  
Options: 1..40

### 4.3.7 Super IO Configuration

Aptio Setup Utility - Copyright (C) 2012 American Megatrends, Inc.  
Advanced

<pre> Super IO Configuration Super IO Chip                SMC SCH3114 ▶ Serial Port 0 Configuration ▶ Serial Port 1 Configuration ▶ Serial Port 2 Configuration ▶ Serial Port 3 Configuration </pre>	<pre> Set Parameters of Serial Port 0 (COMA) </pre>
	<pre> ←: Select Screen ↑↓: Select Item Enter: Select +/-: Change Opt. F1: General Help F2: Previous Values F3: Optimized Defaults F4: Save &amp; Exit ESC: Exit </pre>

Version 2.15.1236. Copyright (C) 2012 American Megatrends, Inc.

- ✓ **Super IO Chip**  
Options: none
- ✓ **Serial Port X Configuration**  
Sub menu: see "Serial Port Configuration" (page 56)

### 4.3.7.1 Serial Port Configuration

Aptio Setup Utility - Copyright (C) 2012 American Megatrends, Inc.  
Advanced

Serial Port 0 Configuration		Enable or Disable Serial Port (COM)
Serial Port	[Enabled]	
Device Settings	IO=3F8h; IRQ=4;	
Change Settings	[Auto]	
Device Mode	[Normal]	
		←: Select Screen ↓: Select Item Enter: Select +/-: Change Opt. F1: General Help F2: Previous Values F3: Optimized Defaults F4: Save & Exit ESC: Exit

Version 2.15.1236. Copyright (C) 2012 American Megatrends, Inc.

- ✓ **Serial Port**  
Options: Enabled / Disabled
- ✓ **Device Settings**  
Options: none
- ✓ **Change Settings**  
Options: Auto / IO=3F8h; IRQ=4 / IO=3F8h; IRQ=3, ...12 / IO=2F8h; IRQ=3, ...12 / IO=3E8h; IRQ=3, ...12 / IO=2E8h; IRQ=3, ...12
- ✓ **Device Mode**  
Options: Normal / High Speed



### 4.3.8 H/W Monitor

Aptio Setup Utility - Copyright (C) 2012 American Megatrends, Inc.  
Advanced

H/W Monitor	
CPU Temperature	: +38'C
Board Temperature	: +25'C
Memory Temperature	: +40'C
SYS FAN Speed	: N/A
CPU FAN Speed	: N/A
AUX FAN Speed	: N/A
+1.05V	: +1.04 V
VccCore	: +1.07 V
+3.3V	: +3.33 V
Vcc	: +4.68 V
+12V	: +12.61 V
VTR	: +3.31 V
Vbat	: +0.13 V
←: Select Screen ↑↓: Select Item Enter: Select +/-: Change Opt. F1: General Help F2: Previous Values F3: Optimized Defaults F4: Save & Exit ESC: Exit	

Version 2.15.1236. Copyright (C) 2012 American Megatrends, Inc.

- ✓ **CPU Temperature**  
Options: none
- ✓ **Board Temperature**  
Options: none
- ✓ **Memory Temperature**  
Options: none
- ✓ **SYS FAN Speed**  
Options: none
- ✓ **CPU FAN Speed**  
Options: none
- ✓ **AUX FAN Speed**  
Options: none
- ✓ **+1.05V**  
Options: none
- ✓ **VccCore**  
Options: none
- ✓ **+3.3V**  
Options: none
- ✓ **Vcc**  
Options: none
- ✓ **+12V**  
Options: none

- ✓ **VTR**  
Options: none
  
- ✓ **Vbat**  
Options: none

### 4.3.9 Serial Port Console Redirection

Aptio Setup Utility - Copyright (C) 2012 American Megatrends, Inc.  
Advanced

COM0 Console Redirection [Enabled] ▶ Console Redirection Settings	Console Redirection Enable or Disable.
COM1 Console Redirection [Disabled] ▶ Console Redirection Settings	
COM2 Console Redirection [Disabled] ▶ Console Redirection Settings	
COM3 Console Redirection [Disabled] ▶ Console Redirection Settings	←: Select Screen ↑↓: Select Item Enter: Select +/-: Change Opt. F1: General Help F2: Previous Values F3: Optimized Defaults F4: Save & Exit ESC: Exit

Version 2.15.1236. Copyright (C) 2012 American Megatrends, Inc.

- ✓ **Console Redirection**  
Options: Enabled / Disabled
- ✓ **Console Redirection Settings**  
Sub menu: see "Console Redirection Settings" (page 60)

## 4.3.9.1 Console Redirection Settings

Aptio Setup Utility - Copyright (C) 2012 American Megatrends, Inc.  
Advanced

COM0 Console Redirection Settings		Emulation: ANSI: Extended ASCII char set. VT100: ASCII char set. VT100+: Extends VT100 to support color, function keys, etc. VT-UTF8: Uses UTF8 encoding to map Unicode chars onto 1 or more bytes.
Terminal Type	[VT-UTF8]	
Bits per second	[115200]	←: Select Screen ↑↓: Select Item Enter: Select +/-: Change Opt. F1: General Help F2: Previous Values F3: Optimized Defaults F4: Save & Exit ESC: Exit
Data Bits	[8]	
Parity	[None]	
Stop Bits	[1]	
Flow Control	[None]	
VT-UTF8 Combo Key Support	[Enabled]	
Recorder Mode	[Disabled]	
Resolution 100x31	[Enabled]	
Legacy OS Redirection Resolution	[80x24]	
Putty KeyPad	[VT100]	
Redirection After BIOS POST	[Always Enable]	

Version 2.15.1236. Copyright (C) 2012 American Megatrends, Inc.

- ✓ **Terminal Type**  
Options: VT100 / VT100+ / VT-UTF8 / ANSI
- ✓ **Bits per second**  
Options: 9600 / 19200 / 38400 / 57600 / 115200
- ✓ **Data Bits**  
Options: 7 / 8
- ✓ **Parity**  
Options: None / Even / Odd / Mark / Space
- ✓ **Stop Bits**  
Options: 1 / 2
- ✓ **Flow Control**  
Options: None / Hardware RTS/CTS
- ✓ **VT-UTF8 Combo Key Support**  
Options: Disabled / Enabled
- ✓ **Recorder Mode**  
Options: Disabled / Enabled
- ✓ **Resolution 100x31**  
Options: Disabled / Enabled
- ✓ **Legacy OS Redirection Resolution**  
Options: 80x24 / 80x25
- ✓ **Putty KeyPad**  
Options: VT100 / LINUX / XTERMR6 / SCO / ESCN / VT400

### 4.3.10 Network Stack

Aptio Setup Utility - Copyright (C) 2012 American Megatrends, Inc.  
Advanced

Network stack	[Enable]	Enable/Disable UEFI network stack
Ipv4 PXE Support	[Enable]	
Ipv6 PXE Support	[Enable]	
		←: Select Screen ↑↓: Select Item Enter: Select +/-: Change Opt. F1: General Help F2: Previous Values F3: Optimized Defaults F4: Save & Exit ESC: Exit

Version 2.15.1236. Copyright (C) 2012 American Megatrends, Inc.

- ✓ **Network Stack**  
Options: Disabled / Enabled
- ✓ **Ipv4 PXE Support**  
Options: Disabled / Enabled
- ✓ **Ipv6 PXE Support**  
Options: Disabled / Enabled

### 4.3.11 CPU PPM Configuration

Aptio Setup Utility - Copyright (C) 2012 American Megatrends, Inc.  
Advanced

CPU PPM Configuration		Enable/Disable Intel SpeedStep
EIST	[Enabled]	
Turbo Mode	[Enabled]	
Config TDP LOCK	[Enabled]	
Long duration power limit	0	
Long duration maintained	1	
Short duration power limit	0	
		←: Select Screen ↑↓: Select Item Enter: Select +/-: Change Opt. F1: General Help F2: Previous Values F3: Optimized Defaults F4: Save & Exit ESC: Exit

Version 2.15.1236. Copyright (C) 2012 American Megatrends, Inc.

- ✓ **EIST**  
Options: Disabled / Enabled
- ✓ **Turbo Mode**  
Options: Enabled / Disabled
- ✓ **Config TDP LOCK**  
Options: Disabled / Enabled
- ✓ **Long duration power limit**  
Options: 0-255
- ✓ **Long duration power maintained**  
Options: 1-120
- ✓ **Short duration power limit**  
Options: 0-255

### 4.3.12 Intel(R) GigabitNetworkConnection

Aptio Setup Utility - Copyright (C) 2012 American Megatrends, Inc.  
Advanced

<pre> PORT CONFIGURATION MENU ▶ NIC Configuration  Blink LEDs                                0  PORT CONFIGURATION INFORMATION UEFI Driver:                             Intel(R) PRO/1000 5.7.06 Adapter PBA:                             FFFFFFF-0FF Chip Type                                 Intel i210 PCI Device ID                             153A Bus:Device:Function                       00:19:00 Link Status                               [Disconnected] MAC Address                               88:88:88:88:87:88         </pre>	<p>Click to configure the network device port.</p> <hr/> <pre> ←: Select Screen ↑↓: Select Item Enter: Select +/-: Change Opt. F1: General Help F2: Previous Values F3: Optimized Defaults F4: Save &amp; Exit ESC: Exit         </pre>
--	---

Version 2.15.1236. Copyright (C) 2012 American Megatrends, Inc.

- ✓ **NIC Configuration**  
Sub menu: see "NIC Configuration" (page 64)
- ✓ **Blink LEDs**  
Options: none
- ✓ **UEFI Driver:**  
Options: none
- ✓ **Adapter PBA:**  
Options: none
- ✓ **Chip Type**  
Options: none
- ✓ **PCI Device ID**  
Options: none
- ✓ **PCI Bus:Device:Function**  
Options: none
- ✓ **Link Status**  
Options: none
- ✓ **Factory MAC Address**  
Options: none

4.3.12.1 NIC Configuration

Aptio Setup Utility - Copyright (C) 2012 American Megatrends, Inc.  
Advanced

Link Speed Wake On LAN	[Auto Neg] [Enabled]	Specifies the port speed used for the selected boot protocol.
		←: Select Screen ↑: Select Item Enter: Select +/-: Change Opt. F1: General Help F2: Previous Values F3: Optimized Defaults F4: Save & Exit ESC: Exit

Version 2.15.1236. Copyright (C) 2012 American Megatrends, Inc.

- ✓ **Link Speed**  
Options: Auto Negotiated / 10Mbps Half / 10Mbps full / 100Mbps Half / 100Mbps Full
- ✓ **Wake On LAN**  
Options: Enabled / Disabled



## 4.4 Chipset

Aptio Setup Utility - Copyright (C) 2012 American Megatrends, Inc.

Main Advanced Chipset Boot Security Save & Exit

<ul style="list-style-type: none"> <li>▶ PCH-IO Configuration</li> <li>▶ System Agent (SA) Configuration</li> </ul>	<p>System Agent (SA) Parameters</p> <hr/> <p>←→: Select Screen        ↑↓: Select Item        Enter: Select        +/-: Change Opt.        F1: General Help        F2: Previous Values        F3: Optimized Defaults        F4: Save &amp; Exit        ESC: Exit</p>
---	---

Version 2.15.1236. Copyright (C) 2012 American Megatrends, Inc.

- ✓ **PCH-IO Configuration**  
 Sub menu: see "PCH-IO Configuration" (page 66)
- ✓ **System Agent (SA) Configuration**  
 Sub menu: see "System Agent (SA) Configuration" (page 73)

## 4.4.1 PCH-IO Configuration

Aptio Setup Utility - Copyright (C) 2012 American Megatrends, Inc.  
Chipset

Intel PCH RC Version	1.5.0.0	PCI Express Configuration settings
Intel PCH SKU Name	QM67	
Intel PCH Rev ID	05/B3	
▶ PCI Express Configuration		
▶ USB Configuration		
▶ PCH Azalia Configuration		
PCH LAN Controller	[Enabled]	
LAN1 MAC address	88:88:88:88:87:88	
Wake on LAN	[Disabled]	
Second LAN Controller	[Enabled]	
LAN2 MAC address	00:01:05:13:90:8F	
CLKRUN# Logic	[Disabled]	
SB Crid	[Disabled]	
High Precision Event Timer Configuration		
High Precision Timer	[Enabled]	
Restore AC Power Loss	[Power On]	
		←: Select Screen ↑: Select Item Enter: Select +/-: Change Opt. F1: General Help F2: Previous Values F3: Optimized Defaults F4: Save & Exit ESC: Exit

Version 2.15.1236. Copyright (C) 2012 American Megatrends, Inc.

- ✓ **Intel PCH RC Version**  
Options: none
- ✓ **Intel PCH SKU Name**  
Options: none
- ✓ **Intel PCH Rev ID**  
Options: none
- ✓ **PCI Express Configuration**  
Sub menu: see "PCI Express Configuration" (page 68)
- ✓ **USB Configuration**  
Sub menu: see "USB Configuration" (page 71)
- ✓ **PCH Azalia Configuration**  
Sub menu: see "PCH Azalia Configuration" (page 72)
- ✓ **PCH LAN Controller**  
Options: Disabled / Enabled
- ✓ **LAN1 MAC address**  
Options: none
- ✓ **Wake on LAN**  
Options: Disabled / Enabled
- ✓ **Second LAN Controller**  
Options: Disabled / Enabled
- ✓ **LAN2 MAC address**  
Options: none

- ✓ **CLKRUN# Logic**  
Options: Disabled
- ✓ **SB CRID**  
Options: Disabled / Enabled
- ✓ **High Precision Timer**  
Options: Disabled / Enabled
- ✓ **Restore AC Power Loss**  
Options: Power Off / Power On / Last State

### 4.4.1.1 PCI Express Configuration

Aptio Setup Utility - Copyright (C) 2012 American Megatrends, Inc.  
Chipset

<pre> PCI Express Configuration  PCI Express Clock Gating           [Enabled] DMI Link ASPM Control              [Enabled] DMI Link Extended Synch Control    [Disabled] PCIe-USB Glitch W/A               [Disabled] Subtractive Decode                 [Disabled]  PCI Express Root Port 1 ▶ PCI Express Root Port 2 ▶ PCI Express Root Port 3 ▶ PCI Express Root Port 4 PCIE Port 5 is assigned to LAN PCIE Port 6 is assigned to LAN2 PCIE Port 7 is assigned to PCIe to PCI Bridge ▶ PCI Express Root Port 8 </pre>	<pre> Enable or disable PCI Express Clock Gating for each root port.  ---: Select Screen ↑↓: Select Item Enter: Select +/-: Change Opt. F1: General Help F2: Previous Values F3: Optimized Defaults F4: Save &amp; Exit ESC: Exit </pre>
--	--

Version 2.15.1236. Copyright (C) 2012 American Megatrends, Inc.

- ✓ **PCI Express Clock Gating**  
Options: Disabled / Enabled
- ✓ **DMI Link ASPM Control**  
Options: Disabled / Enabled
- ✓ **DMI Link Extended Synch Control**  
Options: Disabled / Enabled
- ✓ **PCIe-USB Glitch W/A**  
Options: Disabled / Enabled
- ✓ **Subtractive Decode**  
Options: Disabled
- ✓ **PCI Express Root Port X**  
Sub menu: see "PCI Express Settings" (page 69)

#### 4.4.1.1.1 PCI Express Root Port

Aptio Setup Utility - Copyright (C) 2012 American Megatrends, Inc.  
Chipset

PCI Express Root Port 2	[Enabled]	Control the PCI Express Root Port.
ASPM Support	[Auto]	
URR	[Disabled]	
FER	[Disabled]	
NFER	[Disabled]	
CER	[Disabled]	
CTO	[Disabled]	
SEFE	[Disabled]	
SENF	[Disabled]	
SECE	[Disabled]	
PME SCI	[Enabled]	
Hot Plug	[Disabled]	
PCIe Speed	[Auto]	
Extra Bus Reserved	0	
Reserved Memory	10	
Prefetchable Memory	10	
Reserved I/O	4	
		←: Select Screen ↑↓: Select Item Enter: Select +/-: Change Opt. F1: General Help F2: Previous Values F3: Optimized Defaults F4: Save & Exit ESC: Exit

Version 2.15.1236. Copyright (C) 2012 American Megatrends, Inc.

- ✓ **PCI Express Root Port x**  
Options: Disabled / Enabled
- ✓ **ASPM Support**  
Options: Disabled / L0s / L1 / L0sL1 / Auto
- ✓ **URR**  
Options: Disabled / Enabled
- ✓ **FER**  
Options: Disabled / Enabled
- ✓ **NFER**  
Options: Disabled / Enabled
- ✓ **CER**  
Options: Disabled / Enabled
- ✓ **CTO**  
Options: Disabled / Enabled
- ✓ **SEFE**  
Options: Disabled / Enabled
- ✓ **SENF**  
Options: Disabled / Enabled
- ✓ **SECE**  
Options: Disabled / Enabled
- ✓ **PME SCI**  
Options: Disabled / Enabled

- ✓ **Hot Plug**  
Options: Disabled / Enabled
- ✓ **PCIe Speed**  
Options: Auto / Gen1 / Gen2
- ✓ **Extra Bus Reserved**  
Options: 0...7
- ✓ **Reserved Memory**  
Options: 1...20
- ✓ **Prefetchable Memory**  
Options: 1...20
- ✓ **Reserved I/O**  
Options: 4 / 8 / 12 / 16 / 20

4.4.1.2 USB Configuration

Aptio Setup Utility - Copyright (C) 2012 American Megatrends, Inc.  
Chipset

USB Configuration		Control each of the USB ports (0~13) disabling.
EHCI1	[Enabled]	
EHCI2	[Enabled]	
USB Ports Per-Port Disable Control	[Enabled]	
USB Port #0 Disable	[Enabled]	
USB Port #1 Disable	[Enabled]	
USB Port #2 Disable	[Enabled]	
USB Poer #3 Disable	[Enabled]	
USB Port #4 Disable	[Enabled]	
USB Port #5 Disable	[Enabled]	
USB Port #6 Disable	[Enabled]	
USB Port #7 Disable	[Enabled]	
USB Port #8 Disable	[Enabled]	
USB Port #9 Disable	[Enabled]	
USB Port #10 Disable	[Enabled]	
		←: Select Screen ↑↓: Select Item Enter: Select +/-: Change Opt. F1: General Help F2: Previous Values F3: Optimized Defaults F4: Save & Exit ESC: Exit

Version 2.15.1236. Copyright (C) 2012 American Megatrends, Inc.

- ✓ **EHCI1**  
Options: Enabled
- ✓ **EHCI2**  
Options: Enabled
- ✓ **USB Ports Per-Port Disable Control**  
Options: Disabled / Enabled
- ✓ **USB Port #x Disable**  
Options: Disabled / Enabled

### 4.4.1.3 PCH Azalia Configuration

Aptio Setup Utility - Copyright (C) 2012 American Megatrends, Inc.  
Chipset

<pre> PCH Azalia Configuration Azalia                               [Auto] Azalia PME                           [Disabled] Azalia Internal HDMI Codec           [Enabled] Azalia HDMI codec Port B             [Disabled] Azalia HDMI codec Port C             [Disabled] Azalia HDMI codec Port D             [Enabled] </pre>	<pre> Control Detection of the Azalia device. Disabled = Azalia will be unconditionally disabled Enabled = Azalia will be unconditionally Enabled Auto = Azalia will be enabled if present, disabled otherwise. </pre> <hr/> <pre> ←: Select Screen ↑↓: Select Item Enter: Select +/-: Change Opt. F1: General Help F2: Previous Values F3: Optimized Defaults F4: Save &amp; Exit ESC: Exit </pre>
---	---

Version 2.15.1236. Copyright (C) 2012 American Megatrends, Inc.

- ✓ **Azalia**  
Options: Disabled / Enabled / Auto
- ✓ **Azalia PME**  
Options: Disabled / Enabled
- ✓ **Azalia Internal HDMI Codec**  
Options: Disabled / Enabled
- ✓ **Azalia HDMI codec Port X**  
Options: Disabled / Enabled



## 4.4.2 System Agent (SA) Configuration

Aptio Setup Utility - Copyright (C) 2012 American Megatrends, Inc.  
Chipset

System Agent Bridge Name	SandyBridge	Enable or disable SA CHAP Device.
System Agent RC Version	1.5.0.0	
VT-d Capability	Supported	
VT-d	[Enabled]	
CHAP Device (B0:D7:F0)	[Disabled]	
Thermal Device (B0:D4:F0)	[Disabled]	
Enable NB CRID	[Disabled]	
BDAT ACPI Table Support	[Disabled]	
▶ Graphics Configuration		
▶ NB PCIe Configuration		
		←: Select Screen ↑↓: Select Item Enter: Select +/-: Change Opt. F1: General Help F2: Previous Values F3: Optimized Defaults F4: Save & Exit ESC: Exit

Version 2.15.1236. Copyright (C) 2012 American Megatrends, Inc.

- ✓ **System Agent Bridge Name**  
Options: none
- ✓ **System Agent RC Version**  
Options: none
- ✓ **VT-d Capability**  
Options: none
- ✓ **VT-d**  
Options: Disabled / Enabled
- ✓ **CHAP Device (B0:D7:F0)**  
Options: Disabled / Enabled
- ✓ **Thermal Device (B0:D4:F0)**  
Options: Disabled / Enabled
- ✓ **Enable NB CRID**  
Options: Disabled / Enabled
- ✓ **BDAT ACPI Table Support**  
Options: Disabled / Enabled
- ✓ **Graphics Configuration**  
Sub menu: see "Graphics Configuration" (page 74)
- ✓ **NB PCIe Configuration**  
Sub menu: see "NB PCIe Configuration" (page 76)

## 4.4.2.1 Graphics Configuration

Aptio Setup Utility - Copyright (C) 2012 American Megatrends, Inc.  
Chipset

Graphics Configuration IGFX VBIOS Version                   2137 IGfx Frequency                        650 MHz Graphics Turbo IMON Current         31  Primary Display                       [Auto] Internal Graphics                    [Auto] GTT Size                               [2MB] Aperture Size                         [256MB] DVMT Pre-Allocated                  [64M] DVMT Total Gfx Mem                  [256M] Gfx Low Power Mode                  [Disabled] ▶ LCD Control	Graphics turbo IMON current values supported (14-31)          ←: Select Screen ↑↓: Select Item Enter: Select +/-: Change Opt. F1: General Help F2: Previous Values F3: Optimized Defaults F4: Save & Exit ESC: Exit
--	--

Version 2.15.1236. Copyright (C) 2012 American Megatrends, Inc.

- ✓ **IGFX VBIOS Version**  
Options: none
- ✓ **IGFX Frequency**  
Options: none
- ✓ **Graphics Turbo IMON Current**  
Options: 14...31
- ✓ **Primary Display**  
Options: Auto / IGFX / PEG / PCI
- ✓ **Internal Graphics**  
Options: Auto / Disabled / Enabled
- ✓ **GTT Size**  
Options: 1MB / 2MB
- ✓ **Aperture Size**  
Options: 128MB / 256MB / 512MB
- ✓ **DVMT Pre-Allocated**  
Options: 32M / 64M ... 480M / 512M / 1024M
- ✓ **DVMT Total Gfx Mem**  
Options: 128M / 256M / MAX
- ✓ **Gfx Low Power Mode**  
Options: Disabled / Enabled
- ✓ **LCD Control**  
Sub menu: see "LCD Control" (page 75)

**4.4.2.1.1 LCD Control**

Aptio Setup Utility - Copyright (C) 2012 American Megatrends, Inc.  
Chipset

LCD Control		Select the Video Device which will be activated during POST. This has no effect if external graphics present. Secondary boot display selection will appear based on your selection. VGA modes will be supported only on primary display
Primary IGFX Boot Display	[CRT]	
Secondary IGFX Boot Display	[Disabled]	
LCD Panel Type	[VBIOS Default]	
Spread Spectrum clock Chip	[Off]	
ALS Support	[Disabled]	←: Select Screen ↑↓: Select Item Enter: Select +/-: Change Opt. F1: General Help F2: Previous Values F3: Optimized Defaults F4: Save & Exit ESC: Exit

Version 2.15.1236. Copyright (C) 2012 American Megatrends, Inc.

- ✓ **Primary IGFX Boot Display**  
Options: VBIOS Default / CRT / EFP / LFP / EFP3 / EFP2 / LFP2
- ✓ **Secondary IGFX Boot Display**  
Options: VBIOS Default / CRT / EFP / LFP / EFP3 / EFP2 / LFP2
- ✓ **LCD Panel Type**  
Options: VBIOS Default / 640x480 LVDS ...1920x1080 LVDS / 2048x1536 LVDS
- ✓ **Spread Spectrum Clock Chip**  
Options: Off / Hardware / Software
- ✓ **ALS Support**  
Options: Disabled / Enabled

## 4.4.2.2 NB PCIe Configuration

Aptio Setup Utility - Copyright (C) 2012 American Megatrends, Inc.  
Chipset

PEG0	Not Present		
PEG0 - Gen X	[Auto]		
PEG0 ASPM	[Auto]		
Enable PEG	[Auto]		
Detect Non-Compliance Device	[Disabled]		
De-Emphasis Control	[-3.5 dB]		
PEG Sampler Calibrate	[Auto]		
Swing Control	[Full]		
Gen3 Equalization	[Enabled]		
Gen3 Eq Phase 2	[Disabled]		
▶ PEG Gen3 Root Port Preset Value for each Lane			
▶ PEG Gen3 Endpoint Preset Value each Lane			
▶ PEG Gen3 Endpoint Hint Value each Lane			
Gen3 Eq Preset Search	[Enabled]		
Always re-search Gen3 Eq Preset	[Disabled]		
Preset Search Dwell Time	100		
Timing Margin Steps	2		
Timing Start Margin	15		
Voltage Margin Steps	2		
Voltage Start Margin	20		
Favor Timing Margin	[Disabled]		
PEG Link Disabled	[Disabled]		
Fast PEG Init	[Enabled]		

Configure PEG0 B0:D1:F0  
Gen1-Gen3

---

←: Select Screen  
↑↓: Select Item  
Enter: Select  
+/-: Change Opt.  
F1: General Help  
F2: Previous Values  
F3: Optimized Defaults  
F4: Save & Exit  
ESC: Exit

Version 2.15.1236. Copyright (C) 2012 American Megatrends, Inc.

- ✓ **PEGn - Gen X**  
Options: Auto / Gen1 / Gen2 / Gen3
- ✓ **PEGn ASPM**  
Options: Disabled / Auto / ASPM L0s / ASPM L1 / ASPM L0sL1
- ✓ **Enable PEG**  
Options: Disabled / Enabled / Auto
- ✓ **Detect Non-Compliance Device**  
Options: Disabled / Enabled
- ✓ **De-emphasis Control**  
Options: -6 dB / -3.5 dB
- ✓ **PEG Sampler Calibrate**  
Options: Auto / Disabled / Enabled
- ✓ **Swing Control**  
Options: Reduced / Half / Full
- ✓ **Gen3 Equalization**  
Options: Disabled / Enabled
- ✓ **Gen3 Eq Phase 2**  
Options: Auto / Enabled / Disabled
- ✓ **Gen3 Root Port Preset Value for each Lane**  
Sub menu: see "PEG Gen3 Root Port Preset Value for each Lane" (page 78)
- ✓ **PEG Gen3 Endpoint Preset Value for each Lane**  
Sub menu: see "PEG Gen3 Endpoint Preset Value each Lane" (page 79)

- 
- ✓ **PEG Gen3 Endpoint Hint Value for each Lane**  
Sub menu: see "PEG Gen3 Endpoint Hint Value each Lane" (page 80)
  
  - ✓ **Gen3 Eq Preset Search**  
Options: Enabled / Disabled
  
  - ✓ **Always re-search Gen3 Eq Preset**  
Options: Enabled / Disabled
  
  - ✓ **Preset Search Dwell Time**  
Options: 0-65535
  
  - ✓ **Timing Margin Steps**  
Options: 1-255
  
  - ✓ **Timing Start Margin**  
Options: 4-255
  
  - ✓ **Voltage Margin Steps**  
Options: 1-255
  
  - ✓ **Voltage Start Margin**  
Options: 4-255
  
  - ✓ **Favor Timing Margin**  
Options: Enabled / Disabled
  
  - ✓ **PEG Link Disabled**  
Options: Disabled / Enabled
  
  - ✓ **Fast PEG Init**  
Options: Disabled / Enabled
  
  - ✓ **RxCeM Loop back**  
Options: Disabled / Enabled
  
  - ✓ **RxCeM Loop back lane**  
Options: Lane 0...15
  
  - ✓ **PCIe Gen3 RxCTLEp Setting**  
Options: 0...15

**4.4.2.2.1 PEG Gen3 Root Port Preset Value for each Lane**

Aptio Setup Utility - Copyright (C) 2012 American Megatrends, Inc.  
Chipset

PEG Gen3 Root Port Preset Value for each Lane	Lane 0 Root port preset value for Gen3 Equalization.
Gen3 Root Port Preset Lane 0           8	
Gen3 Root Port Preset Lane 1           8	
Gen3 Root Port Preset Lane 2           8	
Gen3 Root Port Preset Lane 3           8	
Gen3 Root Port Preset Lane 4           8	
Gen3 Root Port Preset Lane 5           8	
Gen3 Root Port Preset Lane 6           8	
Gen3 Root Port Preset Lane 7           8	
Gen3 Root Port Preset Lane 8           8	
Gen3 Root Port Preset Lane 9           8	
Gen3 Root Port Preset Lane 10          8	
Gen3 Root Port Preset Lane 11          8	
Gen3 Root Port Preset Lane 12          8	
Gen3 Root Port Preset Lane 13          8	
Gen3 Root Port Preset Lane 14          8	
Gen3 Root Port Preset Lane 15          8	
	←: Select Screen ↑: Select Item Enter: Select +/-: Change Opt. F1: General Help F2: Previous Values F3: Optimized Defaults F4: Save & Exit ESC: Exit

Version 2.15.1236. Copyright (C) 2012 American Megatrends, Inc.

- ✓ **Gen3 Root Port Preset Value for each Lane**  
Options: 1..11

**4.4.2.2 PEG Gen3 Endpoint Preset Value each Lane**

Aptio Setup Utility - Copyright (C) 2012 American Megatrends, Inc.  
Chipset

<pre>PEG Gen3 Endpoint Preset Value each Lane Gen3 Root Port Preset Lane 0      7 Gen3 Root Port Preset Lane 1      7 Gen3 Root Port Preset Lane 2      7 Gen3 Root Port Preset Lane 3      7 Gen3 Root Port Preset Lane 4      7 Gen3 Root Port Preset Lane 5      7 Gen3 Root Port Preset Lane 6      7 Gen3 Root Port Preset Lane 7      7 Gen3 Root Port Preset Lane 8      7 Gen3 Root Port Preset Lane 9      7 Gen3 Root Port Preset Lane 10     7 Gen3 Root Port Preset Lane 11     7 Gen3 Root Port Preset Lane 12     7 Gen3 Root Port Preset Lane 13     7 Gen3 Root Port Preset Lane 14     7 Gen3 Root Port Preset Lane 15     7</pre>	<pre>Lane 0 End point preset value for Gen3 Equalization.  ---: Select Screen ↑↓: Select Item Enter: Select +/-: Change Opt. F1: General Help F2: Previous Values F3: Optimized Defaults F4: Save &amp; Exit ESC: Exit</pre>
---	--

Version 2.15.1236. Copyright (C) 2012 American Megatrends, Inc.

- ✓ **Gen3 Endpoint Preset Value each Lane**  
Options: 0..11

### 4.4.2.2.3 PEG Gen3 Endpoint Hint Value each Lane

Aptio Setup Utility - Copyright (C) 2012 American Megatrends, Inc.  
Chipset

PEG Gen3 Endpoint Hint Value each Lane	Lane 0 End Point Hint value for Gen3 Equalization.
Gen3 Root Port Preset Lane 0	2
Gen3 Root Port Preset Lane 1	2
Gen3 Root Port Preset Lane 2	2
Gen3 Root Port Preset Lane 3	2
Gen3 Root Port Preset Lane 4	2
Gen3 Root Port Preset Lane 5	2
Gen3 Root Port Preset Lane 6	2
Gen3 Root Port Preset Lane 7	2
Gen3 Root Port Preset Lane 8	2
Gen3 Root Port Preset Lane 9	2
Gen3 Root Port Preset Lane 10	2
Gen3 Root Port Preset Lane 11	2
Gen3 Root Port Preset Lane 12	2
Gen3 Root Port Preset Lane 13	2
Gen3 Root Port Preset Lane 14	2
Gen3 Root Port Preset Lane 15	2

←: Select Screen  
↑: Select Item  
Enter: Select  
+/-: Change Opt.  
F1: General Help  
F2: Previous Values  
F3: Optimized Defaults  
F4: Save & Exit  
ESC: Exit

Version 2.15.1236. Copyright (C) 2012 American Megatrends, Inc.

- ✓ **PEG Gen3 Endpoint Hint Value each Lane**  
Options: 0..11



## 4.5 Boot

Aptio Setup Utility - Copyright (C) 2012 American Megatrends, Inc.

Main Advanced Chipset Boot Security Save & Exit

Boot Configuration Setup Prompt Timeout                    5 Bootup NumLock State                    [On]	Number of 1/10 sec. to wait for setup activation key. 0 means no wait.
Full Screen Logo                            [Enabled] Fast Boot                                    [Enabled] Skip VGA                                    [Disabled] Skip USB                                    [Disabled] Skip PS2                                    [Disabled]	
CSM16 Module Version                    07.69	
GateA20 Active                            [Upon Request] INT19 Trap Response                    [Postponed] Boot mode select                        [UEFI]	←: Select Screen ↑↓: Select Item Enter: Select +/-: Change Opt. F1: General Help F2: Previous Values F3: Optimized Defaults F4: Save & Exit ESC: Exit
FIXED BOOT ORDER Priorities Boot Option #1                            [UEFI Hard Disk] Boot Option #2                            [UEFI CD/DVD] Boot Option #3                            [UEFI USB Hard Disk] Boot Option #4                            [UEFI USB CD/DVD] Boot Option #5                            [UEFI USB Stick] Boot Option #6                            [UEFI USB Floppy] Boot Option #7                            [UEFI Network]	

Version 2.15.1236. Copyright (C) 2012 American Megatrends, Inc.

- ✓ **Setup Prompt Timeout**  
Options: 0...65535 [x 1/10 sec.]
- ✓ **Bootup NumLock State**  
Options: On / Off
- ✓ **Full Screen Logo**  
Options: Disabled / Enabled
- ✓ **Fast Boot**  
Options: Disabled / Enabled
- ✓ **Skip VGA**  
Options: Disabled / Enabled
- ✓ **Skip USB**  
Options: Disabled / Enabled
- ✓ **Skip PS2**  
Options: Disabled / Enabled
- ✓ **CSM16 Module Version**  
Options: none
- ✓ **GateA20 Active**  
Options: Upon Request / Always
- ✓ **INT9 Trap Response**  
Options: Immediate / Postponed
- ✓ **Boot mode select**  
Options: Legacy / UEFI / DUAL

- ✓ **Fixed Boot Order Priorities**  
Options: Review or change the sequence of available boot devices
- ✓ **Boot Option Priorities**  
Options: Review or change the sequence of available boot devices
- ✓ **CSM Parameters**  
Sub menu: see "CSM Parameters" (page 83)

### 4.5.1 CSM Parameters

Aptio Setup Utility - Copyright (C) 2012 American Megatrends, Inc.  
 Main Advanced Chipset BOOT Security Save & Exit

Launch CSM [Always] Boot option filter [UEFI only] Launch PXE OpROM policy [Enable] Launch Storage OpROM policy [Legacy only] Launch Video OpROM policy [Legacy only]  Other PCI device ROM priority [Legacy OpROM]	Controls the execution of UEFI and Legacy PXE OpROM
←: Select Screen ↑↓: Select Item Enter: Select +/-: Change Opt. F1: General Help F2: Previous Values F3: Optimized Defaults F4: Save & Exit ESC: Exit	

Version 2.15.1236. Copyright (C) 2012 American Megatrends, Inc.

- ✓ **Launch CSM**  
Options: Enabled / Disabled
- ✓ **Boot option filter**  
Options: UEFI and Legacy / Legacy only / UEFI only
- ✓ **Launch PXE OpROM policy**  
Options: Disable / Enable
- ✓ **Launch Storage OpROM policy**  
Options: Do not launch / UEFI only / Legacy only
- ✓ **Launch Video OpROM policy**  
Options: Do not launch / UEFI only / Legacy only
- ✓ **Other PCI device ROM priority**  
Options: UEFI OpROM / Legacy OpROM

## 4.6 Security

Aptio Setup Utility - Copyright (C) 2012 American Megatrends, Inc.

Main Advanced Chipset Boot Security Save & Exit

<p>The password length must be in the following range:</p> <p>Minimum length                      3</p> <p>Maximum length                      20</p> <p>Administrator Password</p> <p>UEFI Secure Boot Management</p> <p>Secure Boot control                      [Enabled]</p> <p>▶ Secure Boot Policy</p> <p>▶ Key Management</p>	<p>Set Administrator Password.</p> <p>When set, this password has to be entered to enter setup</p>
	<p>←: Select Screen</p> <p>↑↓: Select Item</p> <p>Enter: Select</p> <p>+/-: Change Opt.</p> <p>F1: General Help</p> <p>F2: Previous Values</p> <p>F3: Optimized Defaults</p> <p>F4: Save &amp; Exit</p> <p>ESC: Exit</p>

Version 2.15.1236. Copyright (C) 2012 American Megatrends, Inc.

- ✓ **Administrator Password**  
Options: Press [Enter]
- ✓ **Secure Boot control**  
Options: Disabled / Enabled
- ✓ **Secure Boot Policy**  
Sub menu: see "Secure Boot Policy" (page 85)
- ✓ **Key Management**  
Sub menu: see "Key Management" (page 86)

## 4.6.1 Secure Boot Policy

Aptio Setup Utility - Copyright (C) 2012 American Megatrends, Inc.  
Security

Internal FV	[Always Execute]	Image Execution Policy on Security Violation. Image load device path
Option ROM	[Deny Execute]	
Removable Media	[Deny Execute]	
Fixed Media	[Deny Execute]	
		←: Select Screen ↑↓: Select Item Enter: Select +/-: Change Opt. F1: General Help F2: Previous Values F3: Optimized Defaults F4: Save & Exit ESC: Exit

Version 2.15.1236. Copyright (C) 2012 American Megatrends, Inc.

- ✓ **Internal FV**  
Options: Always Execute
- ✓ **Option ROM**  
Options: Always Execute / Always Deny / Allow Execute / Defer Execute / Deny Execute / Query User
- ✓ **Removable Media**  
Options: Always Execute / Always Deny / Allow Execute / Defer Execute / Deny Execute / Query User
- ✓ **Fixed Media**  
Options: Always Execute / Always Deny / Allow Execute / Defer Execute / Deny Execute / Query User

### 4.6.2 Key Management

Aptio Setup Utility - Copyright (C) 2012 American Megatrends, Inc.  
Security

System Mode	Setup	Launches the Filebrowser to set the Platform Key from file
Secure Boot Mode	Disabled	
Platform Key (PK)	NOT INSTALLED	←: Select Screen ↑↓: Select Item Enter: Select +/-: Change Opt. F1: General Help F2: Previous Values F3: Optimized Defaults F4: Save & Exit ESC: Exit
▶ Set PK from File		
▶ Get PK to File		
▶ Delete the PK		
Key Exchange Key Database(KEK)	NOT INSTALLED	
▶ Set KEK from File		
▶ Get KEK to File		
▶ Delete the KEK		
▶ Append an entry to KEK		
Authorized Signature Database(DB)	NOT INSTALLED	
▶ Set DB from File		
▶ Get DB to File		
▶ Delete the DB		
▶ Append an entry to DB		
Forbidden Signature Database(DBX)	NOT INSTALLED	
▶ Set DBX from File		
▶ Get DBX to File		
▶ Delete the DBX		
▶ Append an entry to DBX		
Manage All Factory Keys (PK,KEK,DB,DBX)		
Install Factory Defaults		

Version 2.15.1236. Copyright (C) 2012 American Megatrends, Inc.

- ✓ **System Mode**  
Options: none
- ✓ **Secure Boot Mode**  
Options: none
- ✓ **Set PK from File**  
Options: Press [Enter]
- ✓ **Get PK to File**  
Options: Press [Enter]
- ✓ **Delete the PK**  
Options: Press [Enter]
- ✓ **Set KEK from File**  
Options: Press [Enter]
- ✓ **Get KEK to File**  
Options: Press [Enter]
- ✓ **Delete the KEK**  
Options: Press [Enter]
- ✓ **Append an entry to KEK**  
Options: Press [Enter]
- ✓ **Set DB from File**  
Options: Press [Enter]
- ✓ **Get DB to File**  
Options: Press [Enter]

- ✓ **Delete the DB**  
Options: Press [Enter]
- ✓ **Append an entry to DB**  
Options: Press [Enter]
- ✓ **Set DBX from File**  
Options: Press [Enter]
- ✓ **Get DBX to File**  
Options: Press [Enter]
- ✓ **Delete the DBX**  
Options: Press [Enter]
- ✓ **Append an entry to DBX**  
Options: Press [Enter]
- ✓ **Install Factory Defaults**  
Options: Press [Enter]

## 4.7 Save & Exit

Aptio Setup Utility - Copyright (C) 2012 American Megatrends, Inc.

Main Advanced Chipset Boot Security Save & Exit

<p>Save Changes and Reset Discard Changes and Reset</p> <p>Restore Optimized Defaults Save as User Defaults Restore User Defaults</p> <p>Boot Override IBA GE Slot 00C8 v1381</p>	<p>Reset the system after saving the changes.</p> <hr/> <p>←: Select Screen ↑↓: Select Item Enter: Select +/-: Change Opt. F1: General Help F2: Previous Values F3: Optimized Defaults F4: Save &amp; Exit ESC: Exit</p>
---	--

Version 2.15.1236. Copyright (C) 2012 American Megatrends, Inc.

- ✓ **Save Changes and Reset**  
Options: Press [Enter]
- ✓ **Discard Changes and Reset**  
Options: Press [Enter]
- ✓ **Restore Defaults**  
Options: Press [Enter]
- ✓ **Save as User Defaults**  
Options: Press [Enter]
- ✓ **Restore User Defaults**  
Options: Press [Enter]
- ✓ **Boot Override**  
Options: Press [Enter]
- ✓ **IBA GE Slot 00C8 v1381**  
Options: none



## 4.8 BIOS-Update

If a BIOS update needs to be done, the program "DecdFlash" as well as a bootable medium which contains the newest BIOS version is used for this. It is important, that the program is started from a DOS environment without a virtual memory manager, for example "EMM386.EXE". In case such a memory manager is loaded, the program will stop with an error message.

DecdFlash is a program which provides automatic BIOS updates on any AMI-BIOS boards. All files need to be copied from the .zip-file in another directory.

The system may not be interrupted during the flash process, otherwise the update is stopped and the BIOS is destroyed afterwards.

The program should be started as follows:

```
DecdFlsh BIOS-Filename
```

After checking the name of the BIOS file and its length the BIOS will be programmed.

The flashing takes nearly 75 seconds. The firmware will get updated automatically.



### **CAUTION**

Updating the BIOS in an improper way can render the board unusable. Therefore, you should only update the BIOS if you really need the changes/corrections which come with the new BIOS version.



### **CAUTION**

Before you proceed to update the BIOS you need to make absolutely sure that you have the right BIOS file which was issued for the exact board and exact board revision that you wish to update. If you try to update the BIOS using the wrong file the board will not start up again.

# 5 Mechanical Drawings

## 5.1 PCB: Mounting Holes

A true dimensioned drawing can be found in the PC/104 specification.

**i** **NOTE**

All dimensions are in mil (1 mil = 0,0254 mm)

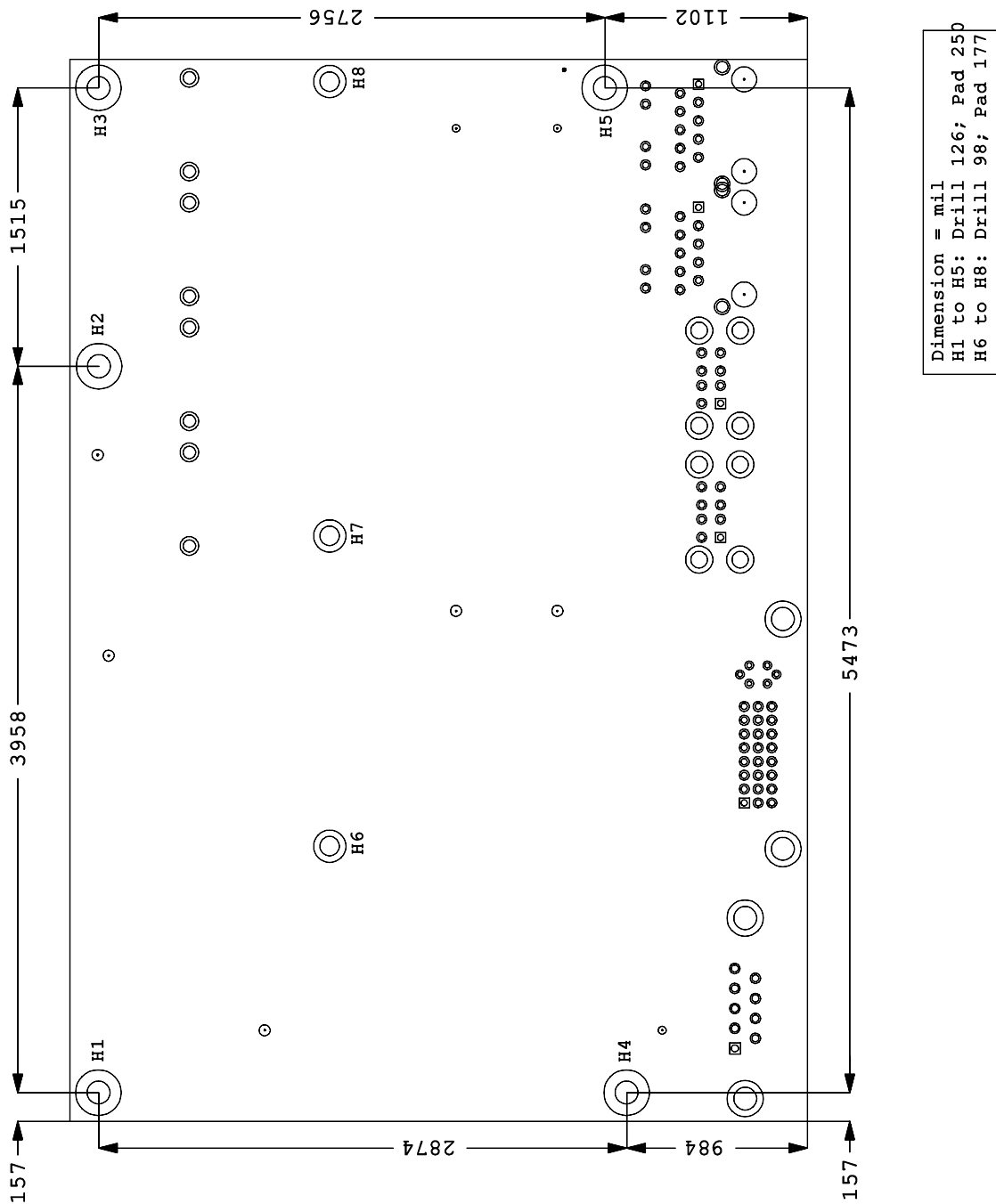

### 5.2 PCB: Pin 1 Dimensions

**i** **NOTE**

All dimensions are in mil (1 mil = 0,0254 mm)

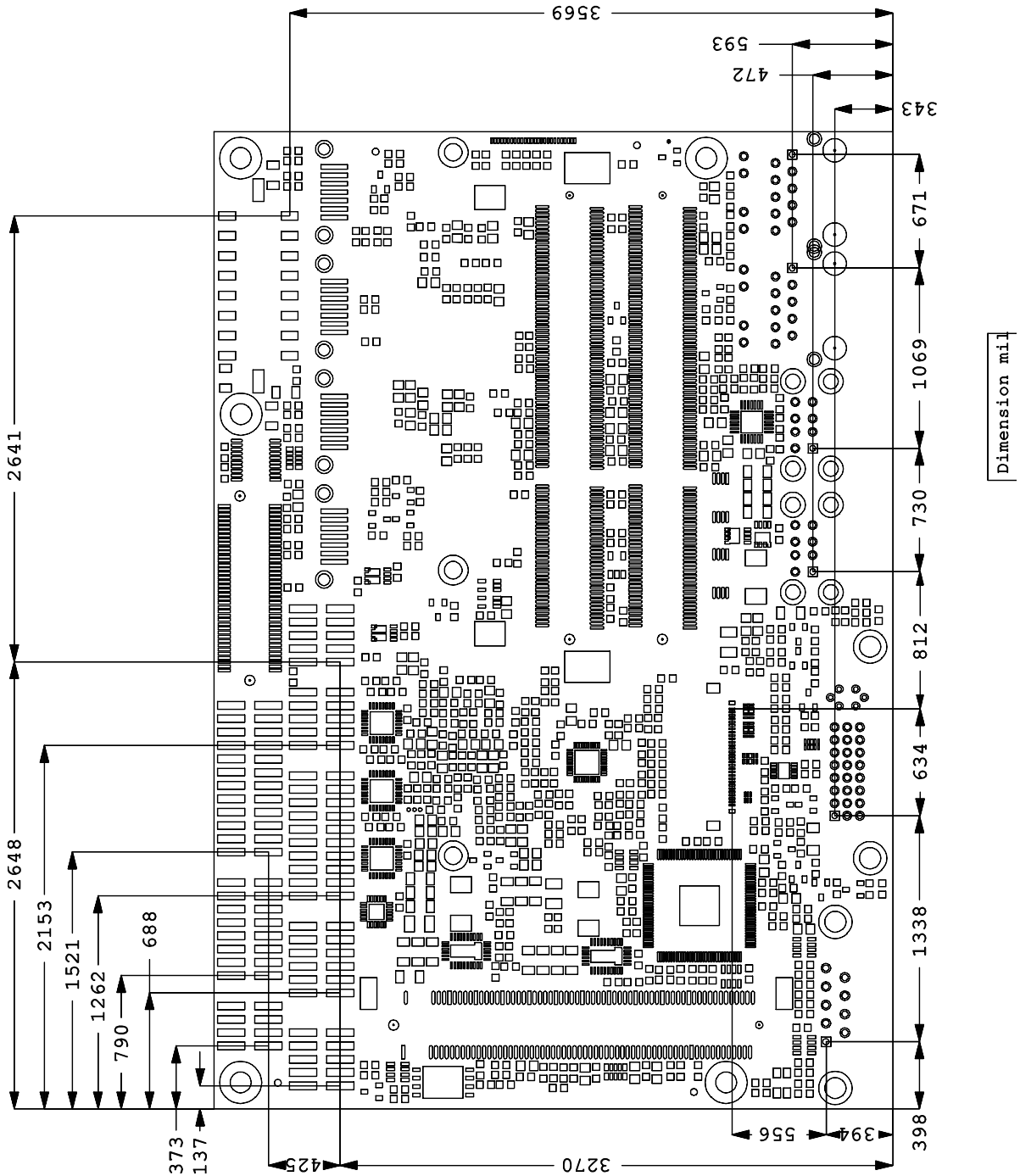

### 5.3 PCB: Die Center



#### NOTE

All dimensions are in mil (1 mil = 0,0254 mm)

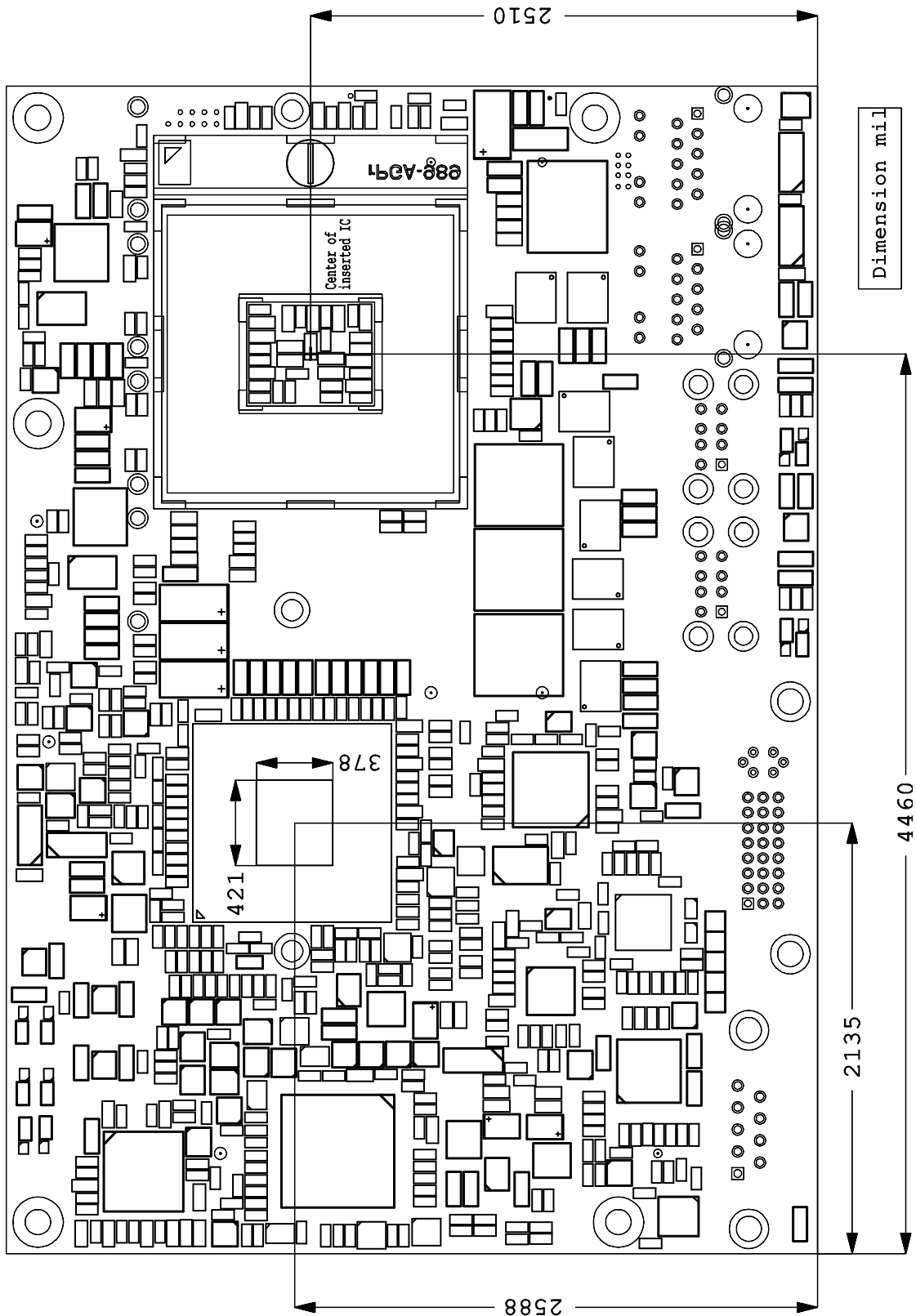

## 6 Technical Data

### 6.1 Electrical Data

#### Power Supply:

Board:	5 Volt +/- 5% (5 Volt Suspend / 12 Volt Fan)
RTC:	>= 3 Volt

#### Electric Power Consumption:

RTC:	<= 10 $\mu$ A
------	---------------

### 6.2 Environmental Conditions

#### Temperature Range:

Operating:	0°C to +60°C (extended temperature on request)
Storage:	-25°C up to +85°C
Shipping:	-25°C up to +85°C, for packaged boards

#### Temperature Changes:

Operating:	0.5°C per minute, 7.5°C per 30 minutes
Storage:	1.0°C per minute
Shipping:	1.0°C per minute, for packaged boards

#### Relative Humidity:

Operating:	5% up to 85% (non condensing)
Storage:	5% up to 95% (non condensing)
Shipping:	5% up to 100% (non condensing), for packaged boards

#### Shock:

Operating:	150m/s <sup>2</sup> , 6ms
Storage:	400m/s <sup>2</sup> , 6ms
Shipping:	400m/s <sup>2</sup> , 6ms, for packaged boards

#### Vibration:

Operating:	10 up to 58Hz, 0.075mm amplitude
	58 up to 500Hz, 10m/s <sup>2</sup>
Storage:	5 up to 9Hz, 3.5mm amplitude
	9 up to 500Hz, 10m/s <sup>2</sup>
Shipping:	5 up to 9Hz, 3.5mm amplitude
	9 up to 500Hz, 10m/s <sup>2</sup> , for packaged boards



### **CAUTION**

Shock and vibration figures pertain to the motherboard alone and do not include additional components such as heat sinks, memory modules, cables etc.

## 6.3 Thermal Specifications

The board is specified to operate in an environmental temperature range from 0°C to +60°C (extended temperature on request). Maximum die temperature is 100°C. To keep the processor under this threshold an appropriate cooling solution needs to be applied. This solution has to take typical and maximum power consumption into account. The maximum power consumption may be twice as high and should be used as a basis for the cooling concept. Additional controllers may also affect the cooling concept. The power consumption of such components may be comparable to the consumption of the processor.

The board design includes thermal solution mounting points that will provide the best possible thermal interface between die and solution. Since we take thermal solutions seriously we have several advanced, aggressive cooling solutions in our product portfolio. Please contact your sales representative to order or discuss your thermal solution needs.



### **CAUTION**

The end customer has the responsibility to ensure that the die temperature of the processor does not exceed 100°C. Permanent overheating may destroy the board!

In case the temperature exceeds 100°C the environmental temperature must be reduced. Under certain circumstances sufficient air circulation must be provided.

## 7 Support and Service

Beckhoff and their partners around the world offer comprehensive support and service, making available fast and competent assistance with all questions related to Beckhoff products and system solutions.

### 7.1 Beckhoff's Branch Offices and Representatives

Please contact your Beckhoff branch office or representative for local support and service on Beckhoff products.

The addresses of Beckhoff's branch offices and representatives around the world can be found on her internet pages: <http://www.beckhoff.com>

You will also find further documentation for Beckhoff components there.

### 7.2 Beckhoff Headquarters

Beckhoff Automation GmbH  
Eiserstr. 5  
33415 Verl  
Germany

phone: +49(0)5246/963-0  
fax: +49(0)5246/963-198  
e-mail: [info@beckhoff.com](mailto:info@beckhoff.com)  
web: [www.beckhoff.com](http://www.beckhoff.com)

#### 7.2.1 Beckhoff Support

Support offers you comprehensive technical assistance, helping you not only with the application of individual Beckhoff products, but also with other, wide-ranging services:

- support
- design, programming and commissioning of complex automation systems
- and extensive training programs for Beckhoff system components

hotline: +49(0)5246/963-157  
fax: +49(0)5246/963-9157  
e-mail: [support@beckhoff.com](mailto:support@beckhoff.com)

#### 7.2.2 Beckhoff Service

The Beckhoff Service Center supports you in all matters of after-sales service:

- on-site service
- repair service
- spare parts service
- hotline service

hotline: +49(0)5246/963-460  
fax: +49(0)5246/963-479  
e-mail: [service@beckhoff.com](mailto:service@beckhoff.com)





## I Annex: Post-Codes

During boot, the BIOS generates a sequence of status codes (so-called "POST codes"), which can be viewed using a special output device (POST code card). The meaning of these codes is described in the document "Aptio™ 4.x Status Codes" by American Megatrends®, which can be downloaded from their website <http://www.ami.com>. The following additional OEM POST codes are generated:

Code	Description
87h	BIOS-API started
88h	PCA9535 started
89h	PWRCTRL-Firmware started

## II Annex: Resources

### IO Range

The used resources depend on setup settings.

The given values are ranges, which are fixed by AT compatibility. Other IO ranges are used, which are dynamically adjusted by Plug & Play BIOS while booting.

Address	Function
0-FF	Reserved IO area of the board
170-17F	
1F0-1F7	
278-27F	
2E8-2EF	COM4
2F8-2FF	COM2
370-377	
378-37F	
3BC-3BF	
3E8-3EF	COM3
3F0-3F7	
3F8-3FF	COM1

### Memory Range

The used resources depend on setup settings.

If the entire range is clogged through option ROMs, these functions do not work anymore.

Address	Function
A0000-BFFFF	VGA RAM
C0000-CFFFF	VGA BIOS
D0000-E7FFF	AHCI BIOS / RAID / PXE (if available)
E8000-FFFFFF	System BIOS

### Interrupt

The used resources depend on setup settings.

The listed interrupts and their use are given through AT compatibility.

If interrupts must exclusively be available on the ISA side, they have to be reserved through the BIOS setup.

The exclusivity is not given and not possible on the PCI side.

Address	Function
IRQ0	Timer
IRQ1	PS/2 Keyboard
IRQ2 (9)	COM3
IRQ3	COM1
IRQ4	COM2
IRQ5	COM4
IRQ6	
IRQ7	
IRQ8	RTC
IRQ9	
IRQ10	
IRQ11	
IRQ12	PS/2 Mouse
IRQ13	FPU

Address	Function
IRQ14	
IRQ15	

## PCI Devices

All listed PCI devices exist on the board. Some PCI devices or functions of devices may be disabled in the BIOS setup. Once a device is disabled other devices may get PCI bus numbers different from the ones listed in the table.

AD	INTA	REQ	Bus	Dev.	Fct.	Controller / Slot
	-	-	0	0	0	Host Bridge ID0104h
	A	-	0	2	0	VGA Graphics ID0116h
	A	-	0	25	0	LAN QM67 ID1502h
	A	-	0	26	0	USB EHCI Controller #2 QM67 ID1C2Dh
	A	-	0	27	0	HDA Controller QM67 ID1C20h
	A	-	0	28	0	PCI Express Port 1 QM67 ID1C10h
	B	-	0	28	1	[PCI Express Port 2 QM67 ID1C12h]
	C	-	0	28	2	[PCI Express Port 3 QM67 ID1C14h]
	D	-	0	28	3	[PCI Express Port 4 QM67 ID1C16h]
	A	-	0	28	4	PCI Express Port 5 QM67 ID1C18h
	B	-	0	28	5	PCI Express Port 6 QM67 ID1C1Ah
	C	-	0	28	6	PCI Express Port 7 QM67 ID1C1Ch
	D	-	0	28	7	[PCI Express Port 8 QM67 ID1C1Eh]
	A	-	0	29	0	USB EHCI Controller #1 QM76 ID1C26h
	-	-	0	31	0	ISA Bridge QM67 ID1C4Fh
	B	-	0	31	2	SATA Interface #1 QM67 ID1C01h
	B	-	0	31	3	SMBus Interface QM67 ID1C22h
	B	-	0	31	5	SATA Interface #2 QM67 ID1C09h
	A	-	m	0	0	LAN 82547L ID10D3h
	A	-	n	0	0	PCIe-to-PCI Bridge IDE111h
20	A	0	o	4	0	mPCI Slot 1

## SMB Devices

The following table contains all reserved SM-Bus device addresses in 8-bit notation. Note that external devices must not use any of these addresses even if the component mentioned in the table is not present on the motherboard.

Address	Function
10-11	Standard slave address
40-41	GPIO
60-61	BIOS internal
70-73	POST code output
88-89	BIOS-defined slave address
A0-A1	DIMM 1
A2-A3	DIMM 2
A4-AF	BIOS internal
B0-BF	BIOS internal
D2-D3	Clock