

BOM LIST			
ITEM	PART NAME	Q'ty	NOTES
1	PLASTIC HOOD	2	ABS
2	2.1 LONG BOLT	2	#4-40
	2.2 SHORT BOLT	2	#4-40
3	NUT	2	M3
4	LONG SCREW	2	M3
5	SMALL WASHER	2	M3
6	SHORT SCREW	2	M3
7	METAL WASHER	2	M3

REV.	DESCRIPTION	DRAWN	CHECKED	APPROVED
A	NEW RELEASE	LJH 08/13/05'	~	LJC 08/13/05'
B	整理图画	YCH 09/13/07'	~	LJC 05/20/10'
C	改M3*12的螺钉为M3*10	YCH 08/30/10'	~	LJC 08/30/10'
D	MINUS P/N CODE	JLZ 12/16/14'	~	

NOTES:

1. PART NUMBER CODE:

DS1046 - 09 X X X X

Washer type (D)
1: Metal

Bolt type
L: Long
S: Short

Packing type
1: Mix packing

Cover Material
C: Chromium plating

Position
09: 9pin

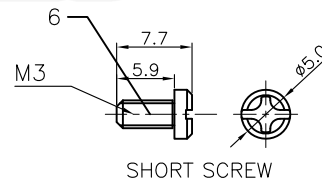
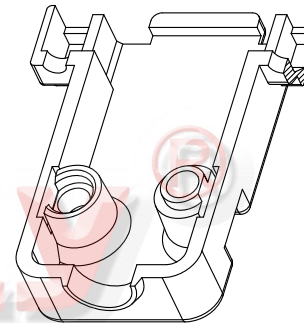

SHORT SCREW

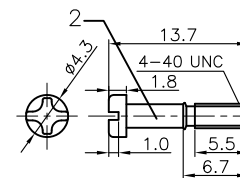

Short BOLT

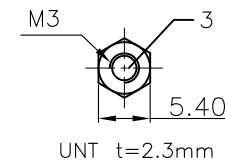

UNT t=2.3mm

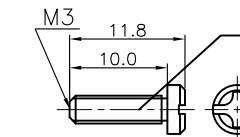

LONG SCREW

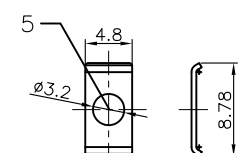

SMALL WASHER

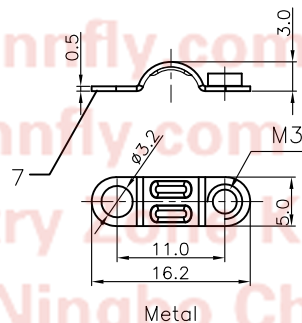
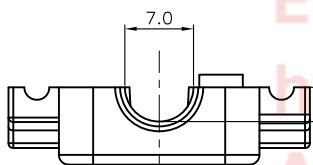
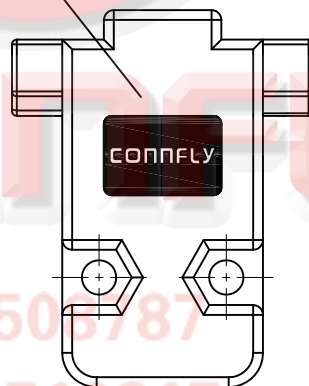
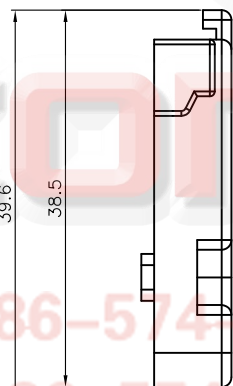
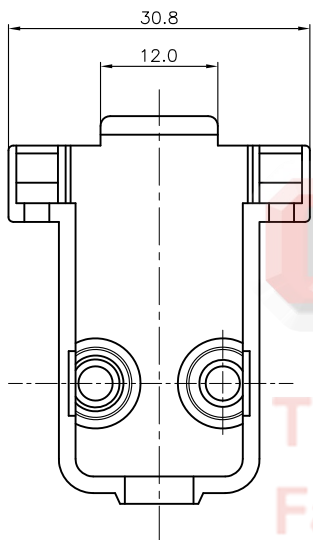

Metal

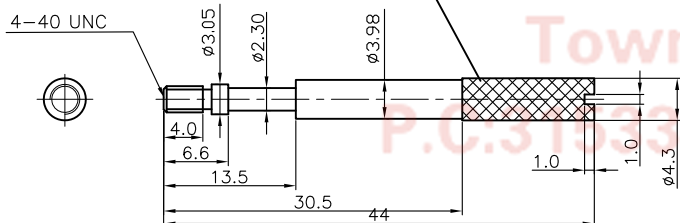

Long BOLT

GENERAL TOLERANCE	ANGLE TOLERANCE
X. ±0.60	X. ±5°
.X ±0.38	.X ±3°
.XX ±0.25	.XX ±2°

PROJECTION	TITLE
UNITS	D-SUB 9pin Hood Chromium Plated
SHEET SIZE	SERIES DS1046 SERIES

DRAWING TYPE	COSTOMER
SCALE	1:1 SHEET 1 OF 1
DRAWING NO.	C-DS1046-09XXXX-C

晨翔电子有限公司
CONNFLY CONNFLY ELECTRONIC CO. LTD

Tel:86-574-63505787
Fax:86-574-63510817
E-mail:sale@connfly.com
http://www.connfly.com
Add:East Industry Zone, KuangYan
Town Cixi Ningbo China
P.C:315333

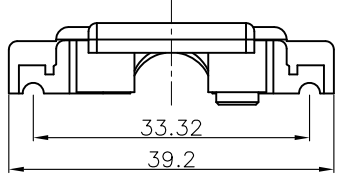

BOM LIST			
ITEM	PART NAME	Q'ty	NOTES
1	PLASTIC HOOD	2	ABS
2	2.1 LONG BOLT	2	#4-40
	2.2 SHORT BOLT	2	#4-40
3	NUT	2	M3
4	LONG SCREW	2	M3
5	SMALL WASHER	2	M3
6	SHORT SCREW	2	M3
7	METAL WASHER	2	M3

REV.	DESCRIPTION	DRAWN	CHECKED	APPROVED
A	NEW RELEASE	LJH 05/18/05'	~	LJC 05/18/05'
B	整理图画	YCH 09/13/07'	~	LJC 09/13/07'
C	MINUS P/N CODE	JLZ 12/16/14'	~	

NOTES:
 1. PART NUMBER CODE:
 DS1046 - 15 X X X X
 Washer type (C)
 1: Metal
 Bolt type
 L: Long
 S: Short
 Packing type
 1: Mix packing
 Cover Material
 C: Chromium plating
 Position
 15: 15pin

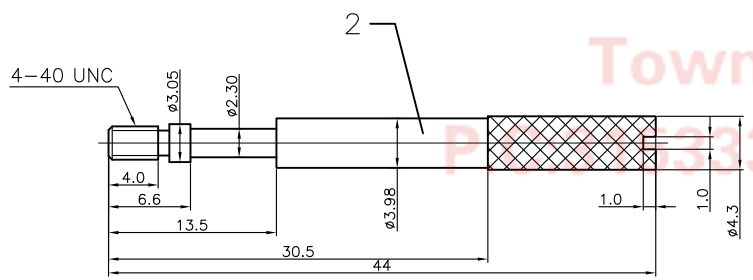
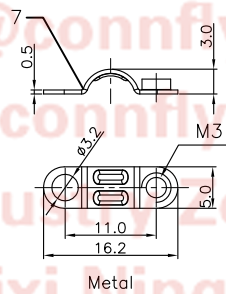
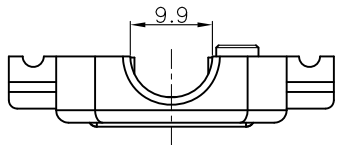
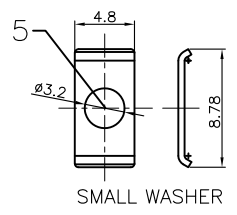
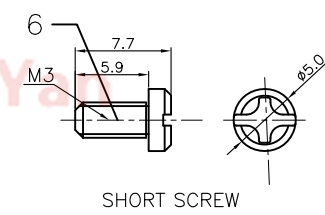
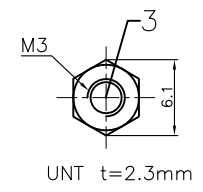
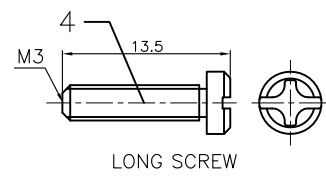
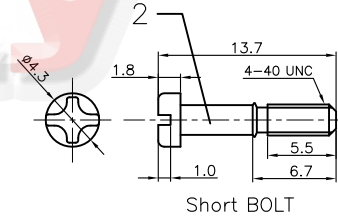
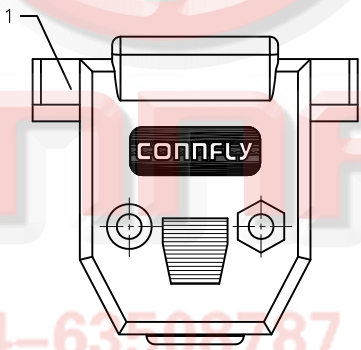
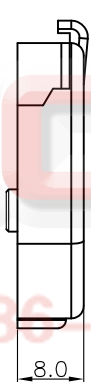
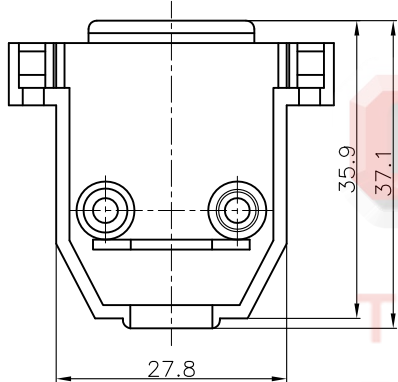
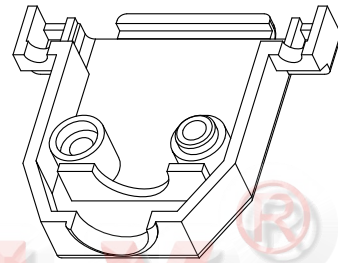

Tel: 86-574-63500787
 Fax: 86-574-63510817
 E-mail: sale@connfly.com
 http://www.connfly.com
 Add: East Industrial Zone Kuang Ya
 Town Cixi Ningbo China

GENERAL TOLERANCE	ANGLE TOLERANCE
X. ±0.60	X. ±5°
.X ±0.38	.X ±3°
.XX ±0.25	.XX ±2°

PROJECTION	TITLE
UNITS	D-SUB 15pin Hood Chromium Plated
SHEET SIZE	SERIES DS1046 SERIES

DRAWING TYPE	CUSTOMER
SCALE	1:1 SHEET 1 OF 1
DRAWING NO.	C-DS1046-15XXXX

晨翔电子有限公司
CONNFLY CONNFLY ELECTRONIC CO. LTD

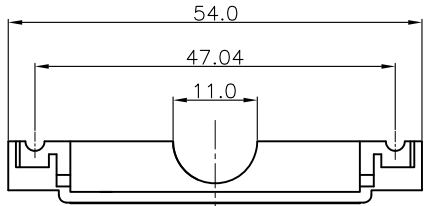

BOM LIST			
ITEM	PART NAME	Q'ty	NOTES
1	PLASTIC HOOD	2	ABS
2	2.1 LONG BOLT	2	#4-40
	2.2 SHORT BOLT	2	#4-40
3	NUT	2	M3
4	LONG SCREW	2	M3
5	SMALL WASHER	2	
6	SHORT SCREW	2	M3
7	METAL WASHER	2	M3

REV.	DESCRIPTION	DRAWN	CHECKED	APPROVED
A	NEW RELEASE	LJH 10/26/05'	~	LJC 10/26/05'
B	整理图面	YCH 09/13/07'	~	LJC 09/13/07'
C	MINUS P/N CODE	JLZ 12/16/14'	~	

NOTES:

1. PART NUMBER CODE:

DS1046 - 25 X X X X

Washer type (C)
1: Metal

Bolt type

L: Long

S: Short

Packing type

1: Mix packing

Cover Material

C: Chromium plating

Position

25: 25pin

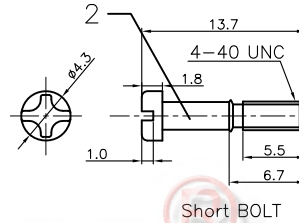

Short BOLT

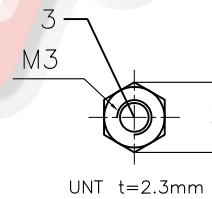

UNT t=2.3mm

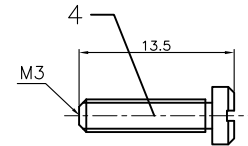

LONG SCREW

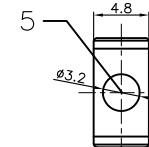

SMALL WASHER

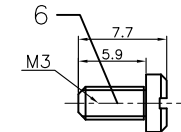

SHORT SCREW

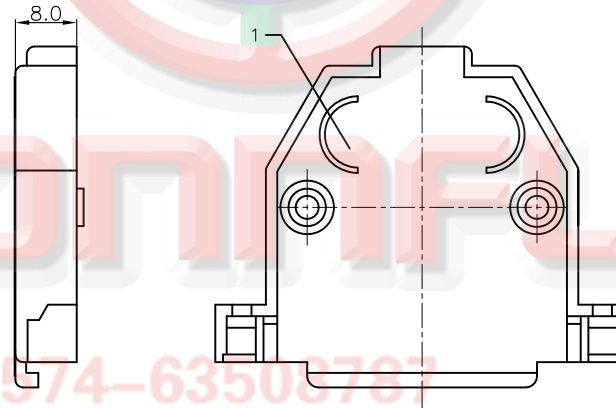
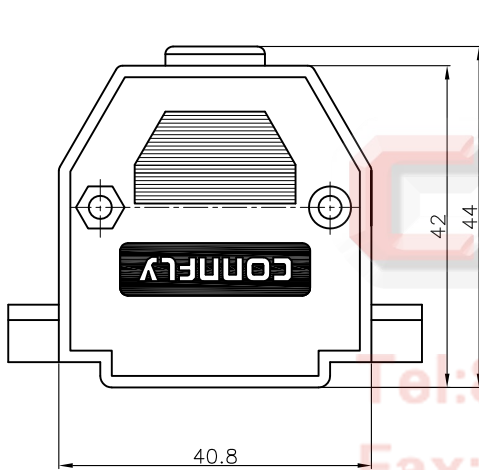

Tel:86-574-63503787
Fax:86-574-63510817
E-mail:sale@connfly.com
http://www.connfly.com
Add:East Industry Zone KuangYan
Town Cixi Ningbo China
P.C:315483

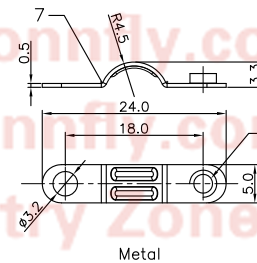

Metal

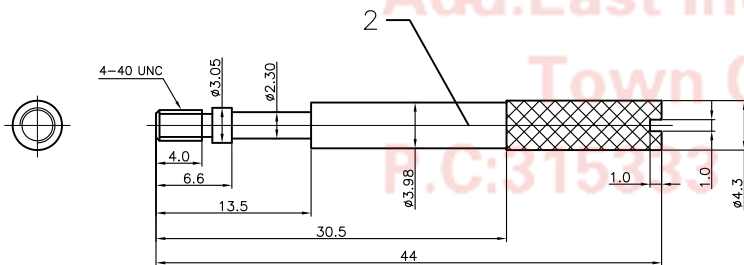

Long BOLT

GENERAL TOLERANCE	ANGLE TOLERANCE
X. ±0.60	X. ±5°
.X ±0.38	.X ±3°
.XX ±0.25	.XX ±2°

PROJECTION	TITLE
UNITS mm	D-SUB 25pin Hood Chromium plated
SHEET SIZE A4	SERIES DS1046 SERIES

DRAWING TYPE	COSTOMER
SCALE 1:1	SHEET 1 OF 1
DRAWING NO. C-DS1046-25XXXX	

晨翔电子有限公司
CONNFLY CONNFLY ELECTRONIC CO. LTD

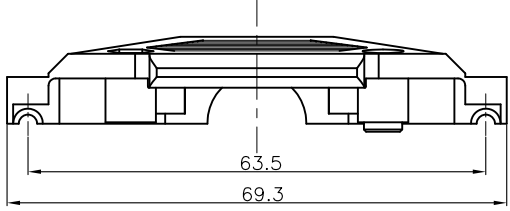

BOM LIST			
ITEM	PART NAME	Q'ty	NOTES
1	PLASTIC HOOD	2	ABS
2	LONG BOLT	2	#4-40
	SHORT BOLT	2	#4-40
3	NUT	2	M3
4	LONG SCREW	2	M3
5	SMALL WASHER	2	
6	SHORT SCREW	2	M3
7	METAL WASHER	2	M3

REV.	DESCRIPTION	DRAWN	CHECKED	APPROVED
A	NEW RELEASE	LJH 10/26/05'	~	LJC 10/26/05'
B	整理图面	YCH 09/13/07'	~	LJC 09/13/07'
C	MINUS P/N CODE	JLZ 12/16/14'	~	

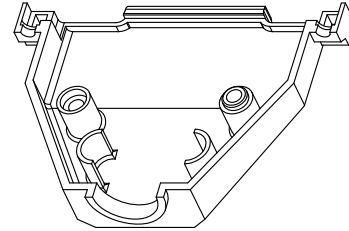

NOTES:
 1. PART NUMBER CODE:
 DS1046 - 37 X X X X
 Washer type (C)
 1: Metal
 Bolt type
 L: Long
 S: Short
 Packing type
 1: Mix packing
 Cover Material
 C: Chromium plating
 Position
 37: 37pin

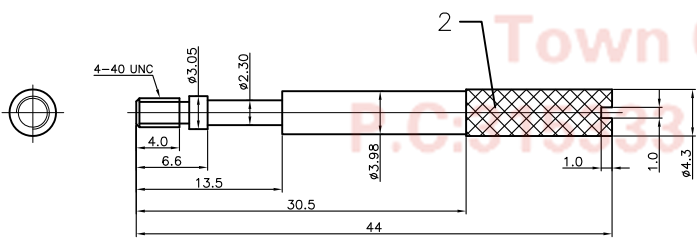
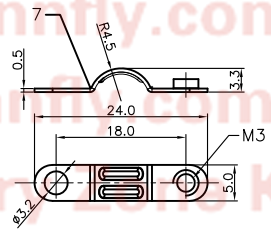
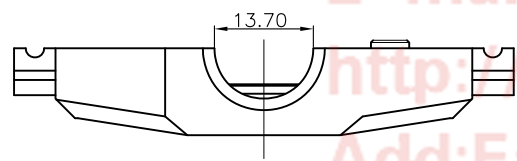
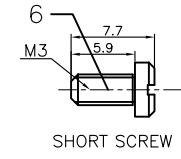
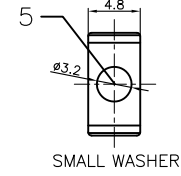
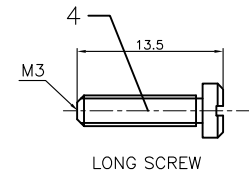
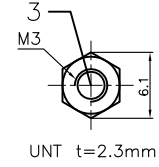
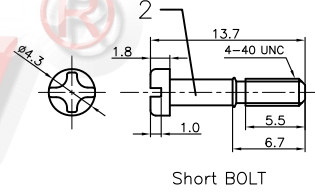
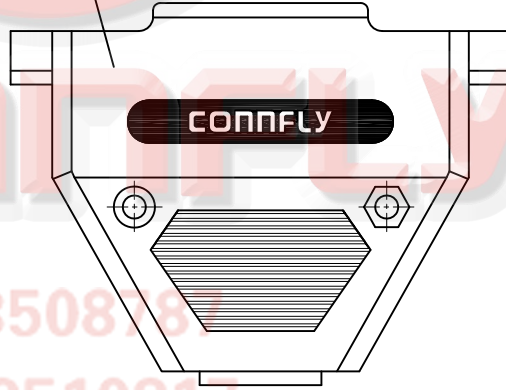
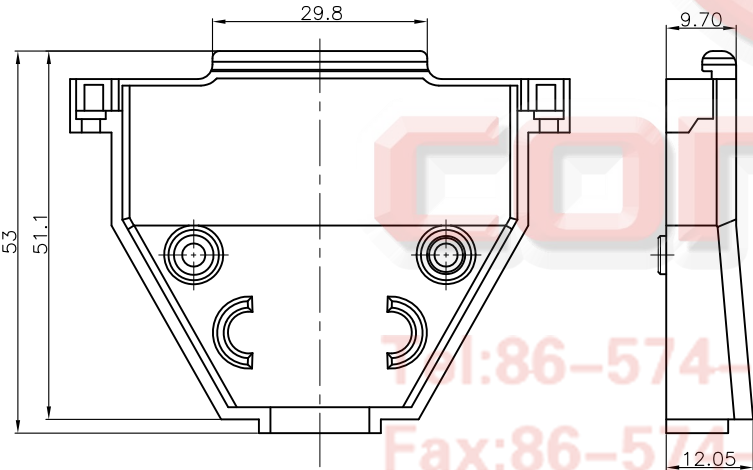

Tel: 86-574-6350878
 Fax: 86-574-63510817
 E-mail: sale@connfly.com
 http://www.connfly.com
 Add: East Industrial Zone, KuangYan Town, Cixi, Ningbo, China

GENERAL TOLERANCE	ANGLE TOLERANCE
X. ±0.60	X. ±5°
.X ±0.38	.X ±3°
.XX ±0.25	.XX ±2°

PROJECTION	TITLE
UNITS: mm	D-SUB 37pin Hood Chromium plated
SHEET SIZE: A4	SERIES: DS1046 SERIES

DRAWING TYPE	CUSTOMER
SCALE: 1:1	SHEET: 1 OF 1
DRAWING NO.: C-DS1046-37XXXX	

晨翔电子有限公司
CONNFLY CONNFLY ELECTRONIC CO. LTD