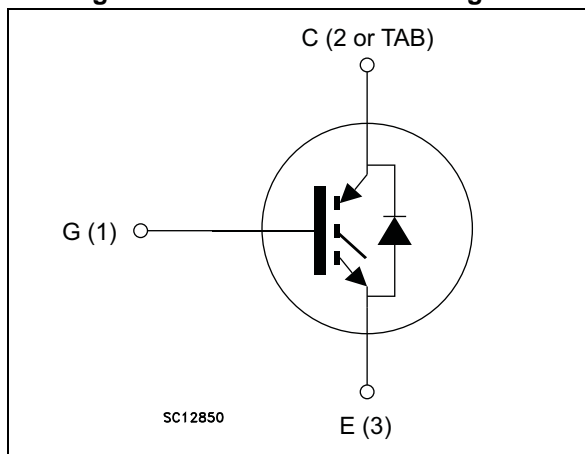

Figure 1. Internal schematic diagram



Features

- Maximum junction temperature: $T_J = 175\text{ }^\circ\text{C}$
- Tail-less switching off
- $V_{CE(sat)} = 1.85\text{ V (typ.) @ } I_C = 60\text{ A}$
- Tight parameter distribution
- Safe paralleling
- Low thermal resistance
- Very fast soft recovery antiparallel diode

Applications

- Photovoltaic inverters
- Uninterruptible power supply
- Welding
- Power factor correction
- Very high frequency converters

Description

These devices are IGBTs developed using an advanced proprietary trench gate field-stop structure. These devices are part of the V series of IGBTs, which represents an optimum compromise between conduction and switching losses to maximize the efficiency of very high frequency converters. Furthermore, a positive $V_{CE(sat)}$ temperature coefficient and very tight parameter distribution result in safer paralleling operation.

Table 1. Device summary

| Order code | Marking | Package | Packing |
|--------------|------------|-------------------|---------|
| STGW60V60DF | GW60V60DF | TO-247 | Tube |
| STGWA60V60DF | G60V60DF | TO-247 long leads | Tube |
| STGWT60V60DF | GWT60V60DF | TO-3P | Tube |

Contents

- 1 Electrical ratings 3**
- 2 Electrical characteristics 4**
 - 2.1 Electrical characteristics (curves) 6
- 3 Test circuits 11**
- 4 Package information 12**
 - 4.1 TO-247 package information 13
 - 4.2 TO-247 long leads package information 15
 - 4.3 TO-3P package information 17
- 5 Revision history 19**

1 Electrical ratings

Table 2. Absolute maximum ratings

| Symbol | Parameter | Value | Unit |
|-------------------------|---|-------------------|------|
| V_{CES} | Collector-emitter voltage ($V_{GE} = 0$) | 600 | V |
| I_C | Continuous collector current at $T_C = 25\text{ °C}$ | 80 ⁽¹⁾ | A |
| I_C | Continuous collector current at $T_C = 100\text{ °C}$ | 60 | A |
| I_{CP} ⁽²⁾ | Pulsed collector current | 240 | A |
| V_{GE} | Gate-emitter voltage | ± 20 | V |
| I_F | Continuous forward current at $T_C = 25\text{ °C}$ | 80 ⁽¹⁾ | A |
| I_F | Continuous forward current at $T_C = 100\text{ °C}$ | 60 | A |
| I_{FP} ⁽²⁾ | Pulsed forward current | 240 | A |
| P_{TOT} | Total dissipation at $T_C = 25\text{ °C}$ | 375 | W |
| T_{STG} | Storage temperature range | - 55 to 150 | °C |
| T_J | Operating junction temperature range | - 55 to 175 | °C |

1. Current level is limited by bond wires
2. Pulse width limited by maximum junction temperature.

Table 3. Thermal data

| Symbol | Parameter | Value | Unit |
|------------|--|-------|------|
| R_{thJC} | Thermal resistance junction-case IGBT | 0.4 | °C/W |
| R_{thJC} | Thermal resistance junction-case diode | 1.14 | °C/W |
| R_{thJA} | Thermal resistance junction-ambient | 50 | °C/W |

2 Electrical characteristics

$T_J = 25\text{ °C}$ unless otherwise specified.

Table 4. Static characteristics

| Symbol | Parameter | Test conditions | Min. | Typ. | Max. | Unit |
|---------------|--|--|------|------|-----------|---------------|
| $V_{(BR)CES}$ | Collector-emitter breakdown voltage ($V_{GE} = 0$) | $I_C = 2\text{ mA}$ | 600 | | | V |
| $V_{CE(sat)}$ | Collector-emitter saturation voltage | $V_{GE} = 15\text{ V}, I_C = 60\text{ A}$ | | 1.85 | 2.3 | V |
| | | $V_{GE} = 15\text{ V}, I_C = 60\text{ A}$ $T_J = 125\text{ °C}$ | | 2.15 | | |
| | | $V_{GE} = 15\text{ V}, I_C = 60\text{ A}$ $T_J = 175\text{ °C}$ | | 2.35 | | |
| V_F | Forward on-voltage | $I_F = 60\text{ A}$ | | 2 | 2.6 | V |
| | | $I_F = 60\text{ A}, T_J = 125\text{ °C}$ | | 1.7 | | V |
| | | $I_F = 60\text{ A}, T_J = 175\text{ °C}$ | | 1.6 | | V |
| $V_{GE(th)}$ | Gate threshold voltage | $V_{CE} = V_{GE}, I_C = 1\text{ mA}$ | 5 | 6 | 7 | V |
| I_{CES} | Collector cut-off current ($V_{GE} = 0$) | $V_{CE} = 600\text{ V}$ | | | 25 | μA |
| I_{GES} | Gate-emitter leakage current ($V_{CE} = 0$) | $V_{GE} = \pm 20\text{ V}$ | | | ± 250 | nA |

Table 5. Dynamic characteristics

| Symbol | Parameter | Test conditions | Min. | Typ. | Max. | Unit |
|-----------|------------------------------|--|------|------|------|------|
| C_{ies} | Input capacitance | $V_{CE} = 25\text{ V}, f = 1\text{ MHz},$ $V_{GE} = 0$ | - | 8000 | - | pF |
| C_{oes} | Output capacitance | | - | 280 | - | pF |
| C_{res} | Reverse transfer capacitance | | - | 170 | - | pF |
| Q_g | Total gate charge | $V_{CC} = 480\text{ V}, I_C = 60\text{ A},$ $V_{GE} = 15\text{ V},$ see Figure 29 | - | 334 | - | nC |
| Q_{ge} | Gate-emitter charge | | - | 130 | - | nC |
| Q_{gc} | Gate-collector charge | | - | 58 | - | nC |

Table 6. IGBT switching characteristics (inductive load)

| Symbol | Parameter | Test conditions | Min. | Typ. | Max. | Unit |
|-----------------|---------------------------|--|------|------|------|------------|
| $t_{d(on)}$ | Turn-on delay time | $V_{CE} = 400\text{ V}$, $I_C = 60\text{ A}$, $R_G = 4.7\ \Omega$, $V_{GE} = 15\text{ V}$, see Figure 28 | - | 60 | - | ns |
| t_r | Current rise time | | - | 20 | - | ns |
| $(di/dt)_{on}$ | Turn-on current slope | | - | 2365 | - | A/ μ s |
| $t_{d(off)}$ | Turn-off delay time | | - | 208 | - | ns |
| t_f | Current fall time | | - | 14 | - | ns |
| $E_{on}^{(1)}$ | Turn-on switching energy | | - | 0.75 | - | mJ |
| $E_{off}^{(2)}$ | Turn-off switching energy | | - | 0.55 | - | mJ |
| E_{ts} | Total switching energy | - | 1.3 | - | mJ | |
| $t_{d(on)}$ | Turn-on delay time | $V_{CE} = 400\text{ V}$, $I_C = 60\text{ A}$, $R_G = 4.7\ \Omega$, $V_{GE} = 15\text{ V}$, $T_J = 175\text{ }^\circ\text{C}$, see Figure 28 | - | 57 | - | ns |
| t_r | Current rise time | | - | 23 | - | ns |
| $(di/dt)_{on}$ | Turn-on current slope | | - | 2191 | - | A/ μ s |
| $t_{d(off)}$ | Turn-off delay time | | - | 216 | - | ns |
| t_f | Current fall time | | - | 27 | - | ns |
| $E_{on}^{(1)}$ | Turn-on switching energy | | - | 1.5 | - | mJ |
| $E_{off}^{(2)}$ | Turn-off switching energy | | - | 0.8 | - | mJ |
| E_{ts} | Total switching energy | - | 2.3 | - | mJ | |

1. Including the reverse recovery of the diode.

2. Including the tail of the collector current.

Table 7. Diode switching characteristics (inductive load)

| Symbol | Parameter | Test conditions | Min. | Typ. | Max. | Unit |
|--------------|--|--|------|------|------|------------|
| t_{rr} | Reverse recovery time | $I_F = 60\text{ A}$, $V_R = 400\text{ V}$, $V_{GE} = 15\text{ V}$, $di_F/dt = 1000\text{ A}/\mu\text{s}$ see Figure 28 | - | 74 | - | ns |
| Q_{rr} | Reverse recovery charge | | - | 703 | - | nC |
| I_{rrm} | Reverse recovery current | | - | 19 | - | A |
| dl_{rr}/dt | Peak rate of fall of reverse recovery current during t_b | | - | 714 | - | A/ μ s |
| E_{rr} | Reverse recovery energy | | - | 184 | - | μ J |
| t_{rr} | Reverse recovery time | $I_F = 60\text{ A}$, $V_R = 400\text{ V}$, $V_{GE} = 15\text{ V}$, $di_F/dt = 1000\text{ A}/\mu\text{s}$ $T_J = 175\text{ }^\circ\text{C}$, see Figure 28 | - | 131 | - | ns |
| Q_{rr} | Reverse recovery charge | | - | 2816 | - | nC |
| I_{rrm} | Reverse recovery current | | - | 43 | - | A |
| dl_{rr}/dt | Peak rate of fall of reverse recovery current during t_b | | - | 404 | - | A/ μ s |
| E_{rr} | Reverse recovery energy | | - | 821 | - | μ J |

2.1 Electrical characteristics (curves)

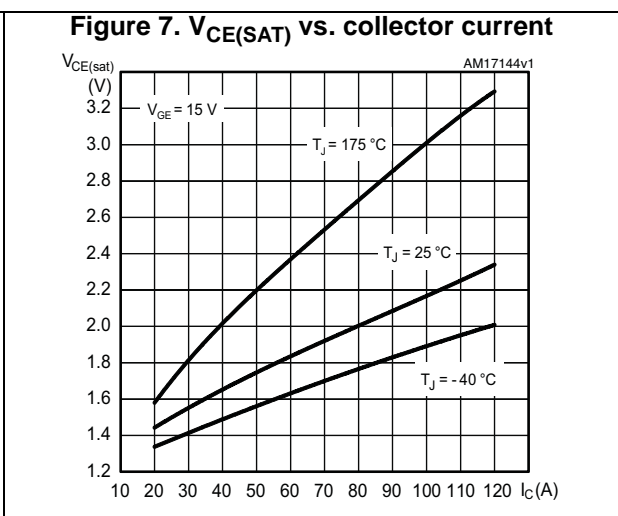
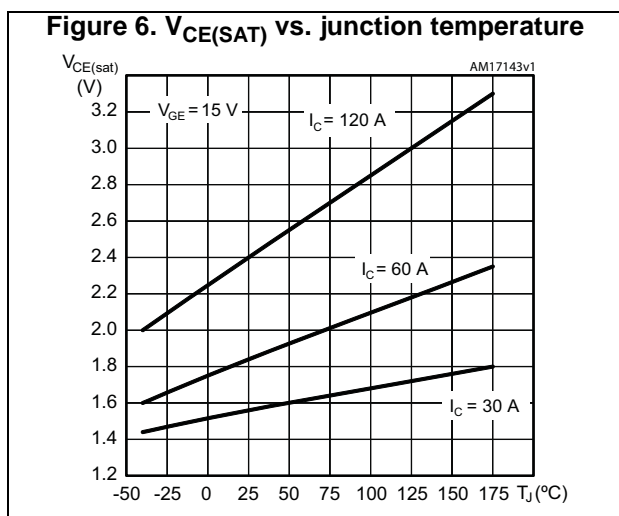
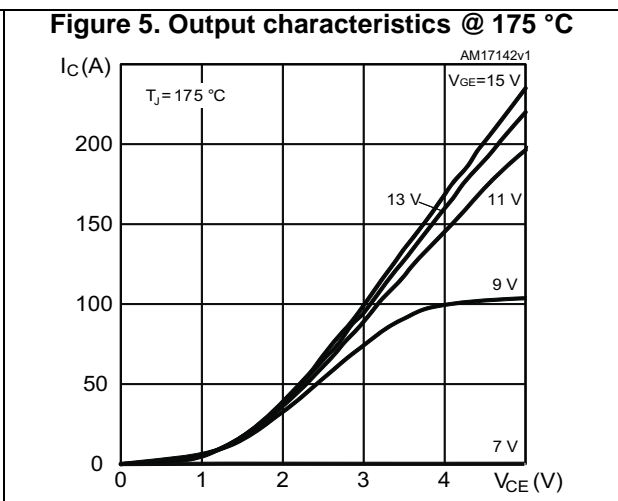
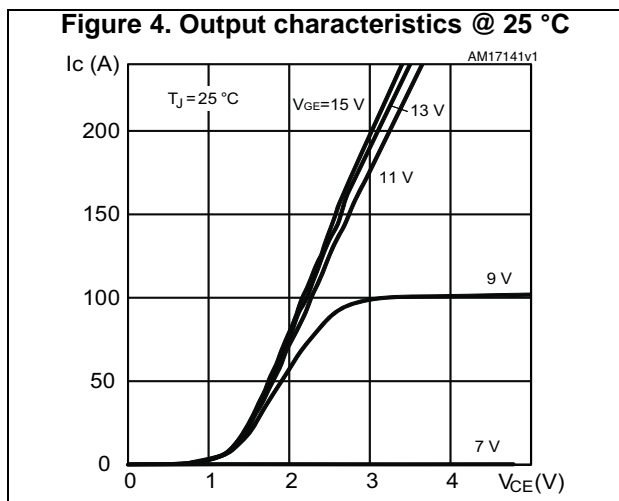
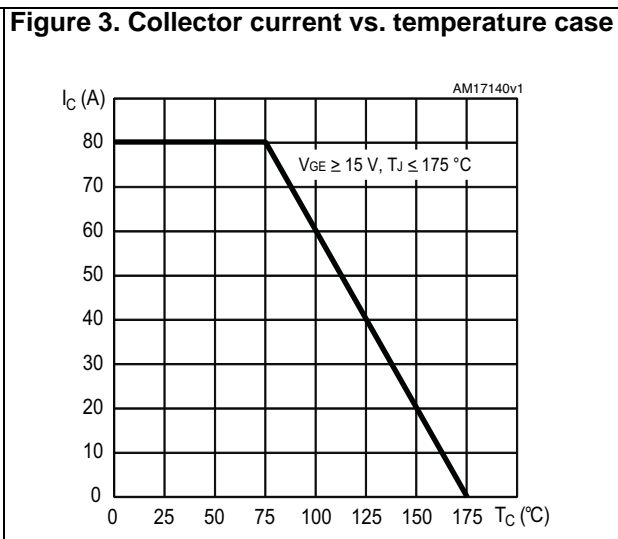
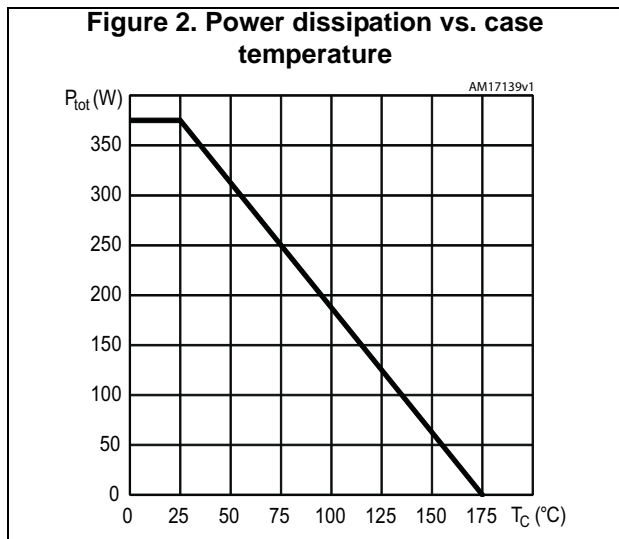

Figure 8. Collector current vs. switching frequency

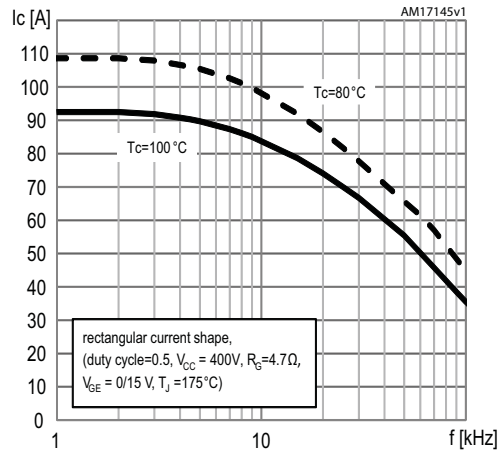

Figure 9. Safe operating area

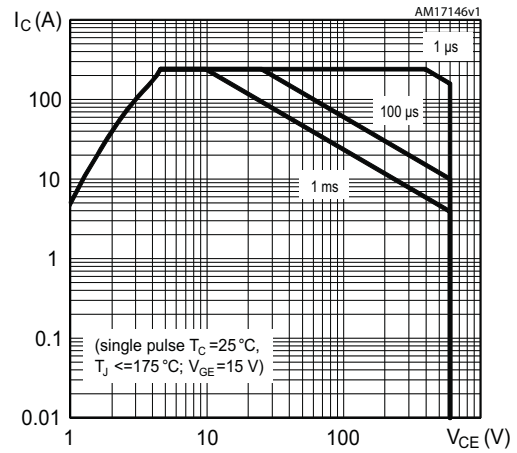

Figure 10. Transfer characteristics

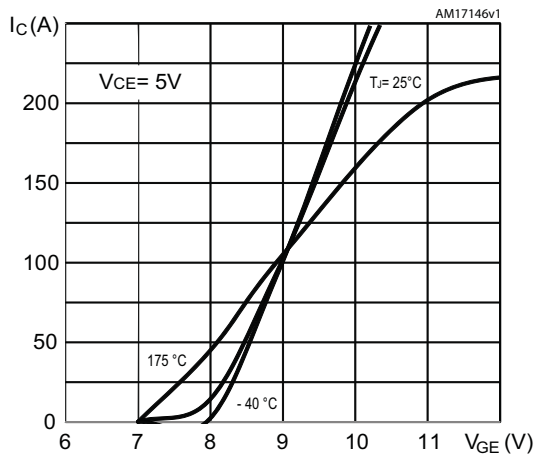

Figure 11. Diode VF vs. forward current

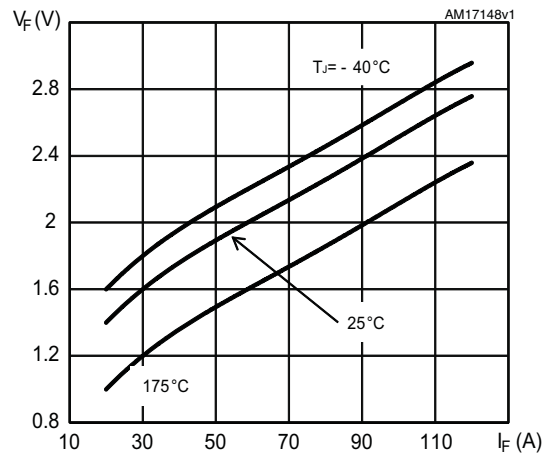

Figure 12. Normalized VGE(th) vs. junction temperature

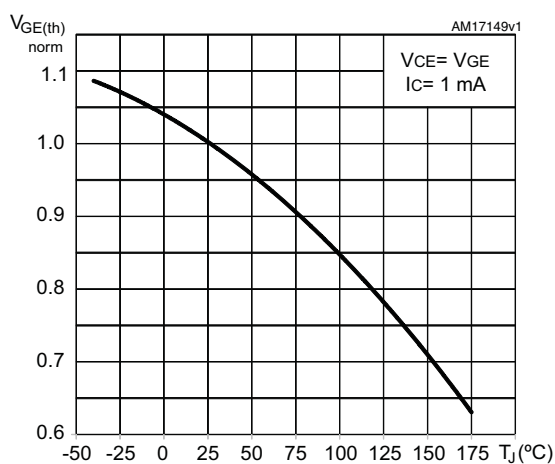
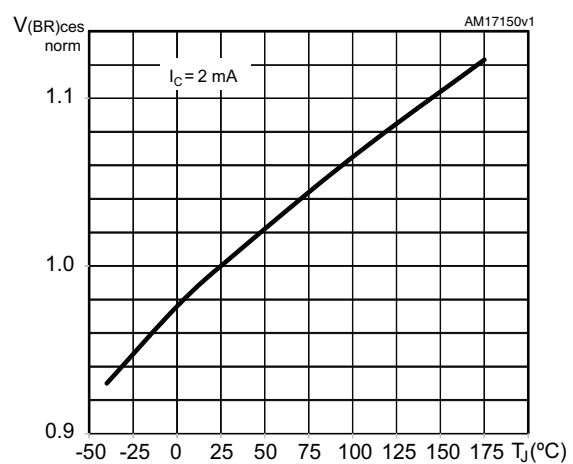

Figure 13. Normalized V(BR)CES vs. junction temperature



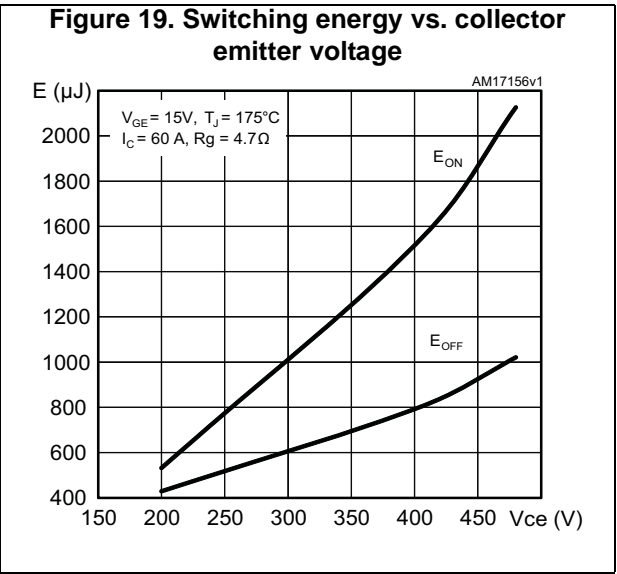
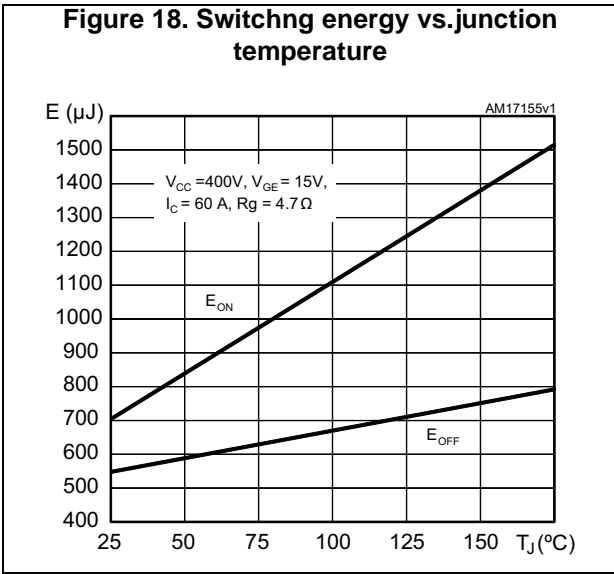
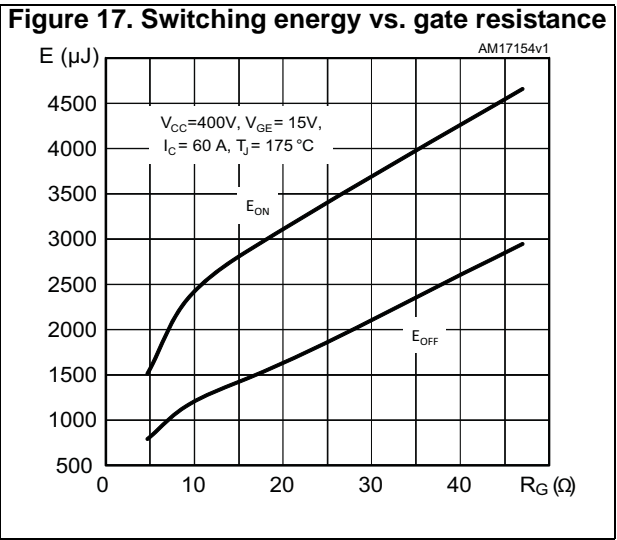
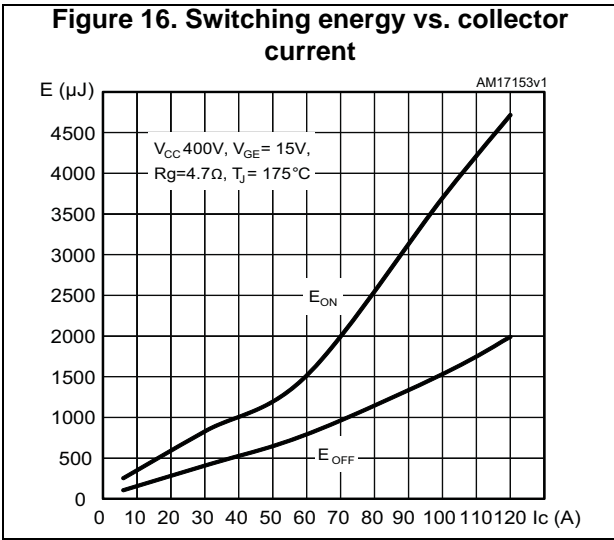
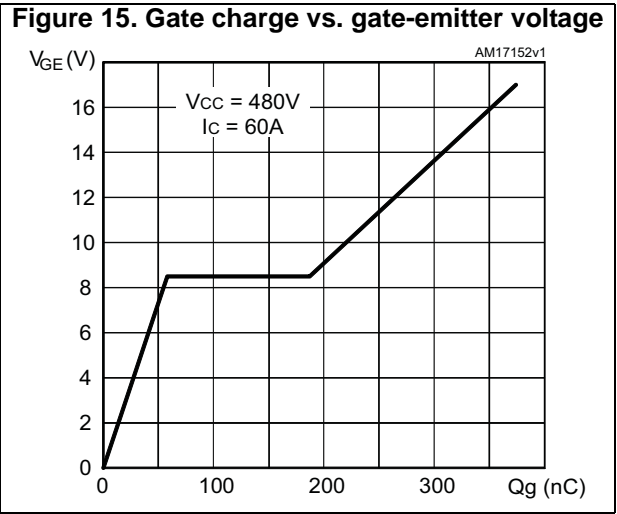
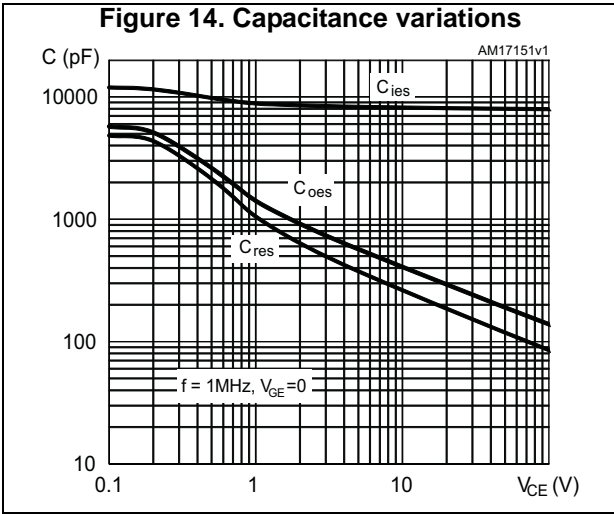

Figure 20. Switching times vs. collector current

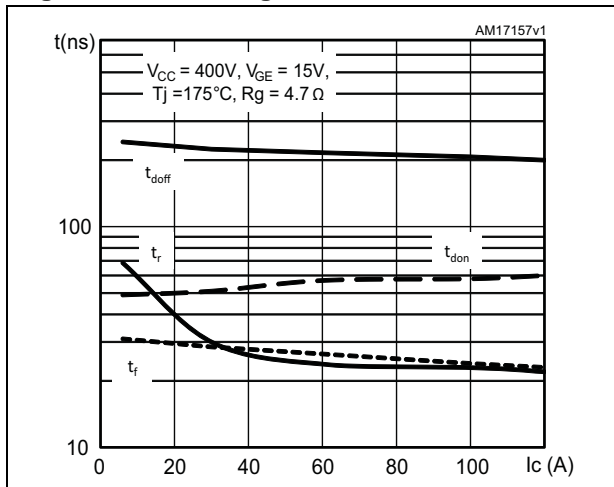

Figure 21. Switching times vs. gate resistance

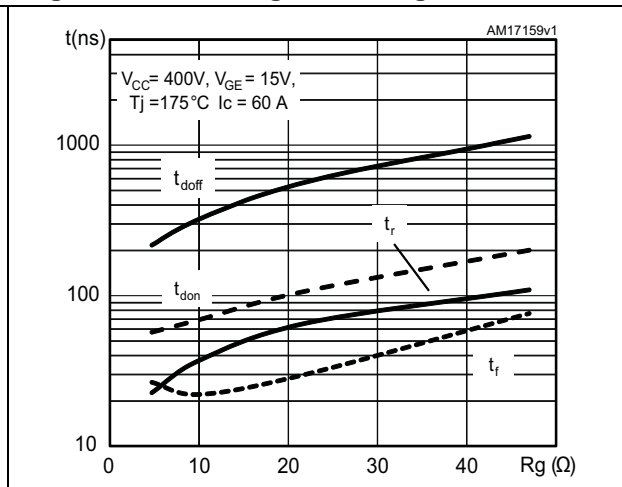

Figure 22. Reverse recovery current vs. diode current slope

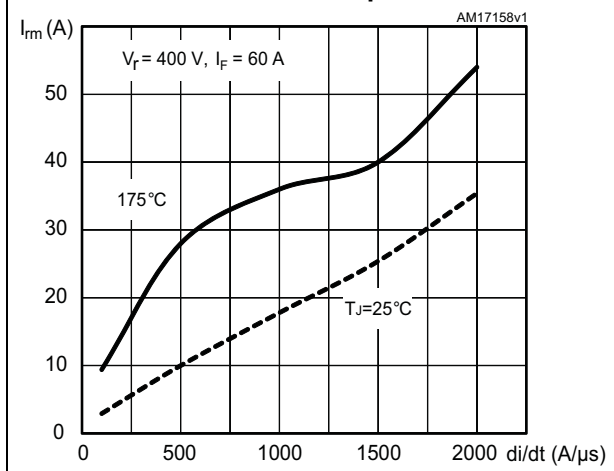

Figure 23. Reverse recovery time vs. diode current slope

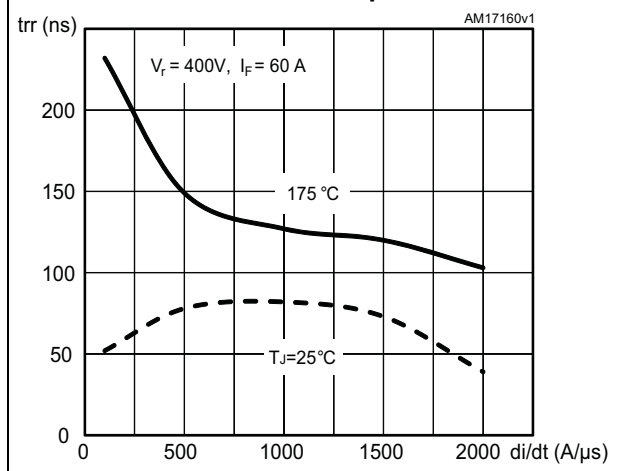

Figure 24. Reverse recovery charge vs. diode current slope

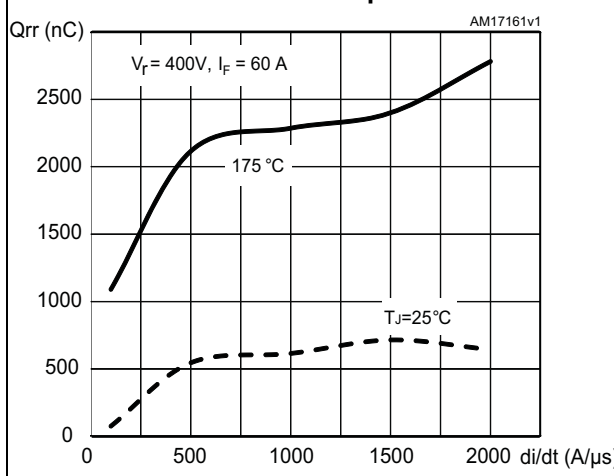

Figure 25. Reverse recovery energy vs. diode current slope

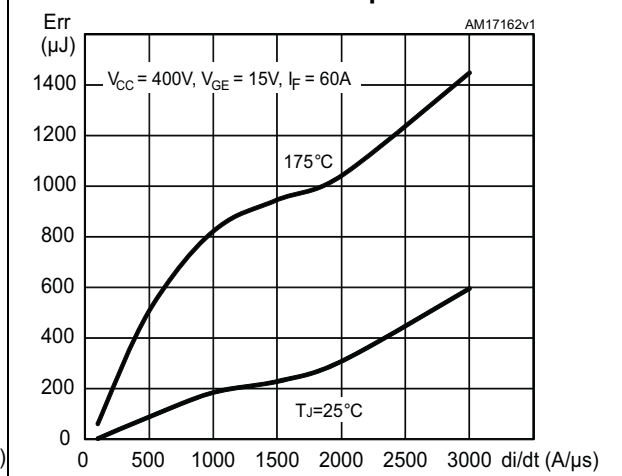

Figure 26. Thermal data for IGBT

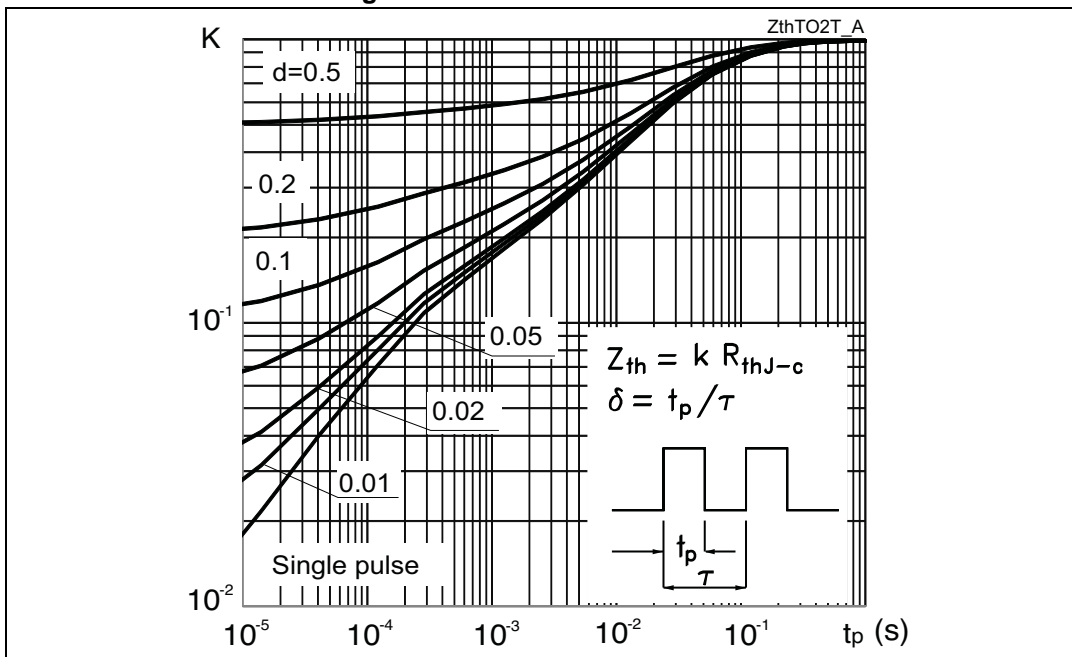
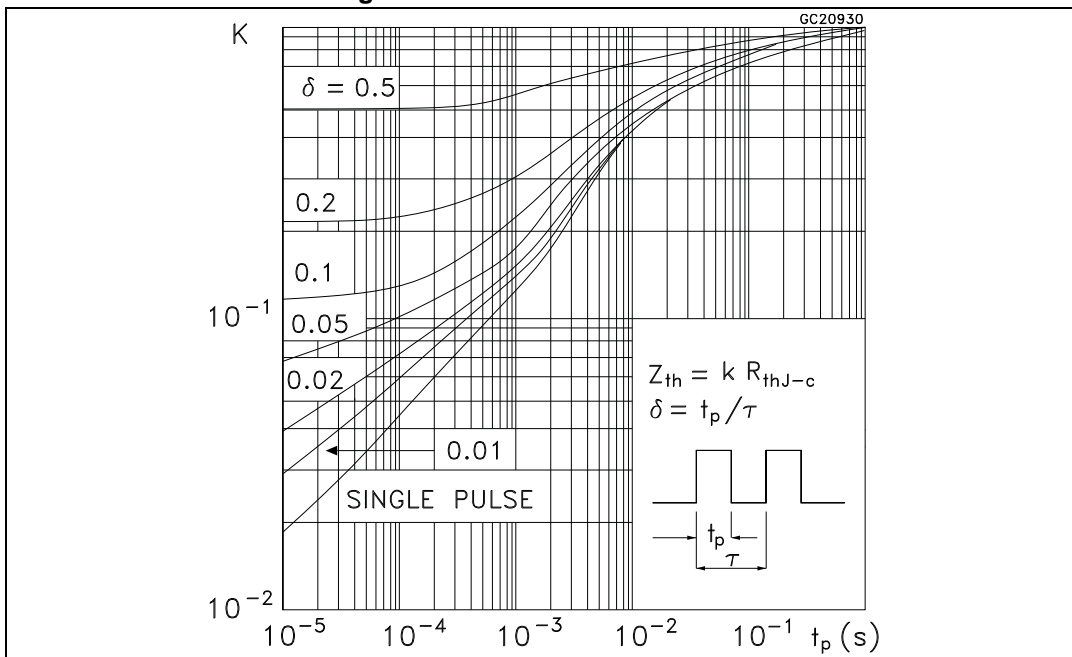
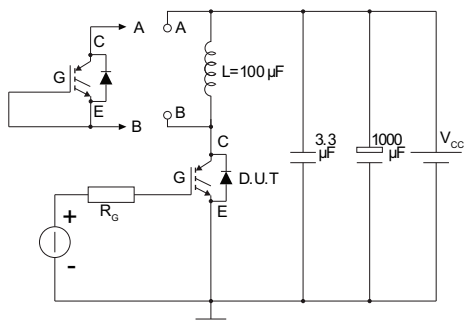

Figure 27. Thermal data for diode



3 Test circuits

Figure 28. Test circuit for inductive load switching



AM01504v1

Figure 29. Gate charge test circuit

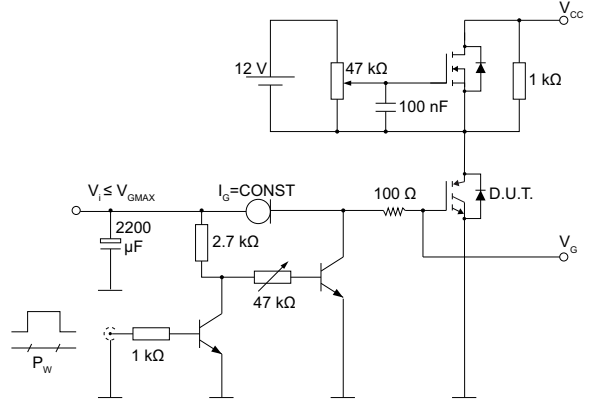

AM01505v1

Figure 30. Switching waveform

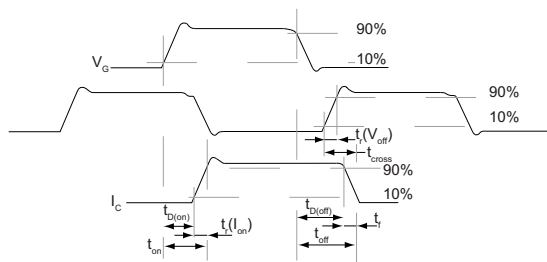

AM01506v1

Figure 31. Diode recovery time waveform

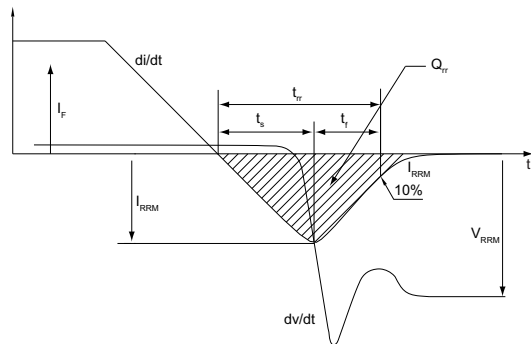

AM01507v1

4 Package information

In order to meet environmental requirements, ST offers these devices in different grades of ECOPACK[®] packages, depending on their level of environmental compliance. ECOPACK[®] specifications, grade definitions and product status are available at: www.st.com. ECOPACK is an ST trademark.

4.1 TO-247 package information

Figure 32. TO-247 package outline

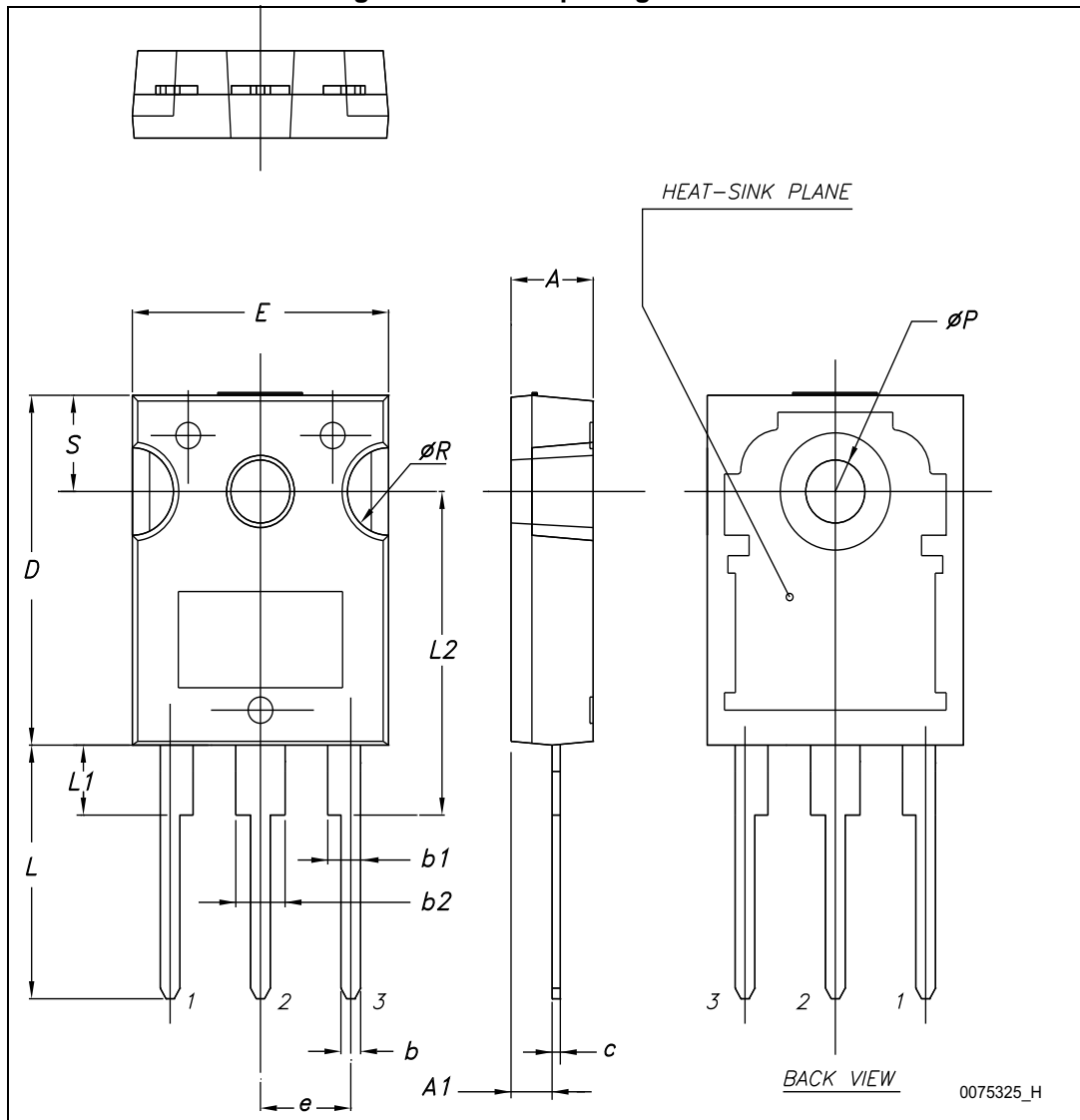

Table 8. TO-247 package mechanical data

| Dim. | mm. | | |
|------|-------|-------|-------|
| | Min. | Typ. | Max. |
| A | 4.85 | | 5.15 |
| A1 | 2.20 | | 2.60 |
| b | 1.0 | | 1.40 |
| b1 | 2.0 | | 2.40 |
| b2 | 3.0 | | 3.40 |
| c | 0.40 | | 0.80 |
| D | 19.85 | | 20.15 |
| E | 15.45 | | 15.75 |
| e | 5.30 | 5.45 | 5.60 |
| L | 14.20 | | 14.80 |
| L1 | 3.70 | | 4.30 |
| L2 | | 18.50 | |
| ØP | 3.55 | | 3.65 |
| ØR | 4.50 | | 5.50 |
| S | 5.30 | 5.50 | 5.70 |

4.2 TO-247 long leads package information

Figure 33. TO-247 long leads package outline

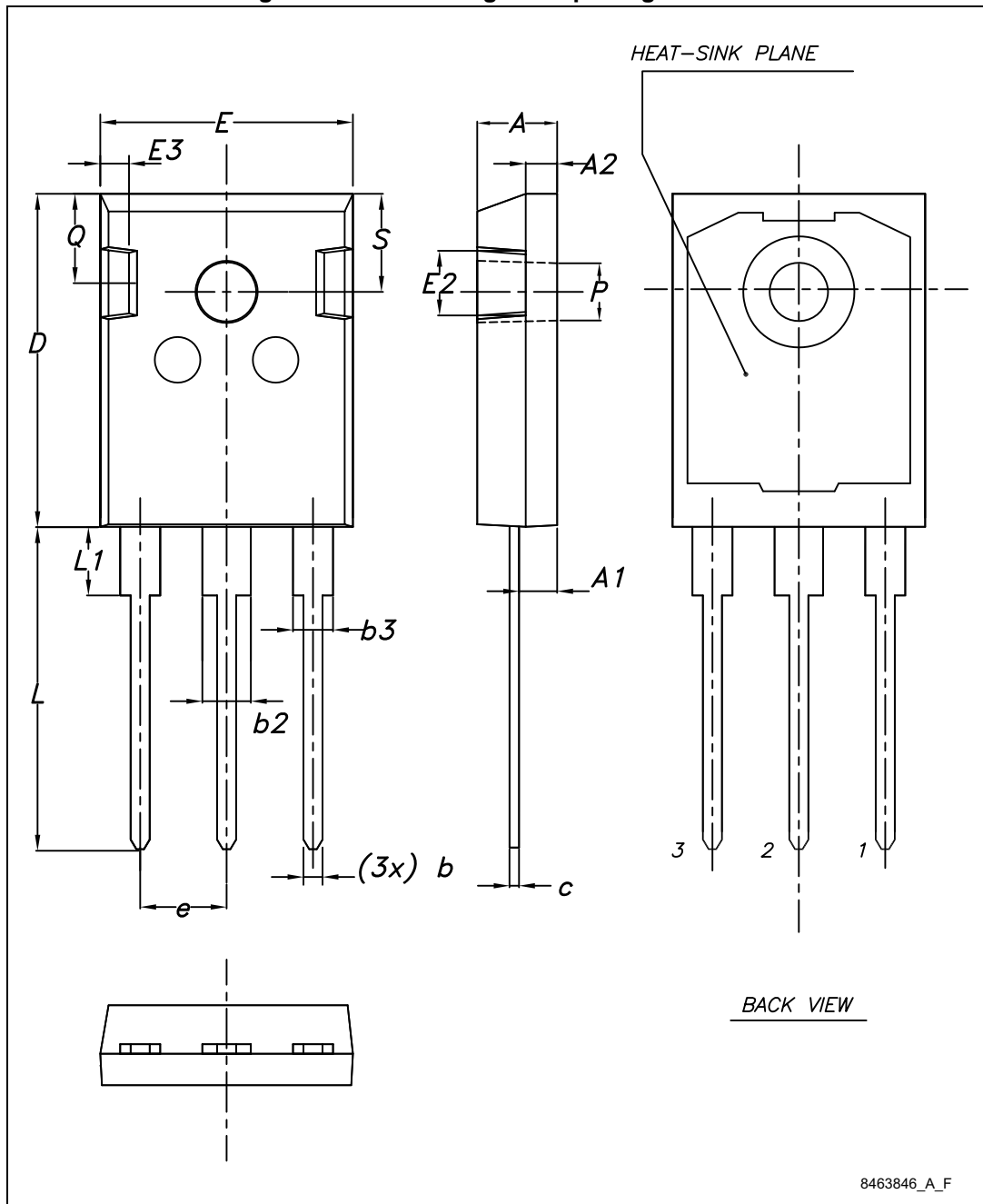

Table 9. TO-247 long leads package mechanical data

| Dim. | mm | | |
|------|-------|-------|-------|
| | Min. | Typ. | Max. |
| A | 4.90 | 5.00 | 5.10 |
| A1 | 2.31 | 2.41 | 2.51 |
| A2 | 1.90 | 2.00 | 2.10 |
| b | 1.16 | | 1.26 |
| b2 | | | 3.25 |
| b3 | | | 2.25 |
| c | 0.59 | | 0.66 |
| D | 20.90 | 21.00 | 21.10 |
| E | 15.70 | 15.80 | 15.90 |
| E2 | 4.90 | 5.00 | 5.10 |
| E3 | 2.40 | 2.50 | 2.60 |
| e | 5.34 | 5.44 | 5.54 |
| L | 19.80 | 19.92 | 20.10 |
| L1 | | | 4.30 |
| P | 3.50 | 3.60 | 3.70 |
| Q | 5.60 | | 6.00 |
| S | 6.05 | 6.15 | 6.25 |

4.3 TO-3P package information

Figure 34. TO-3P package outline

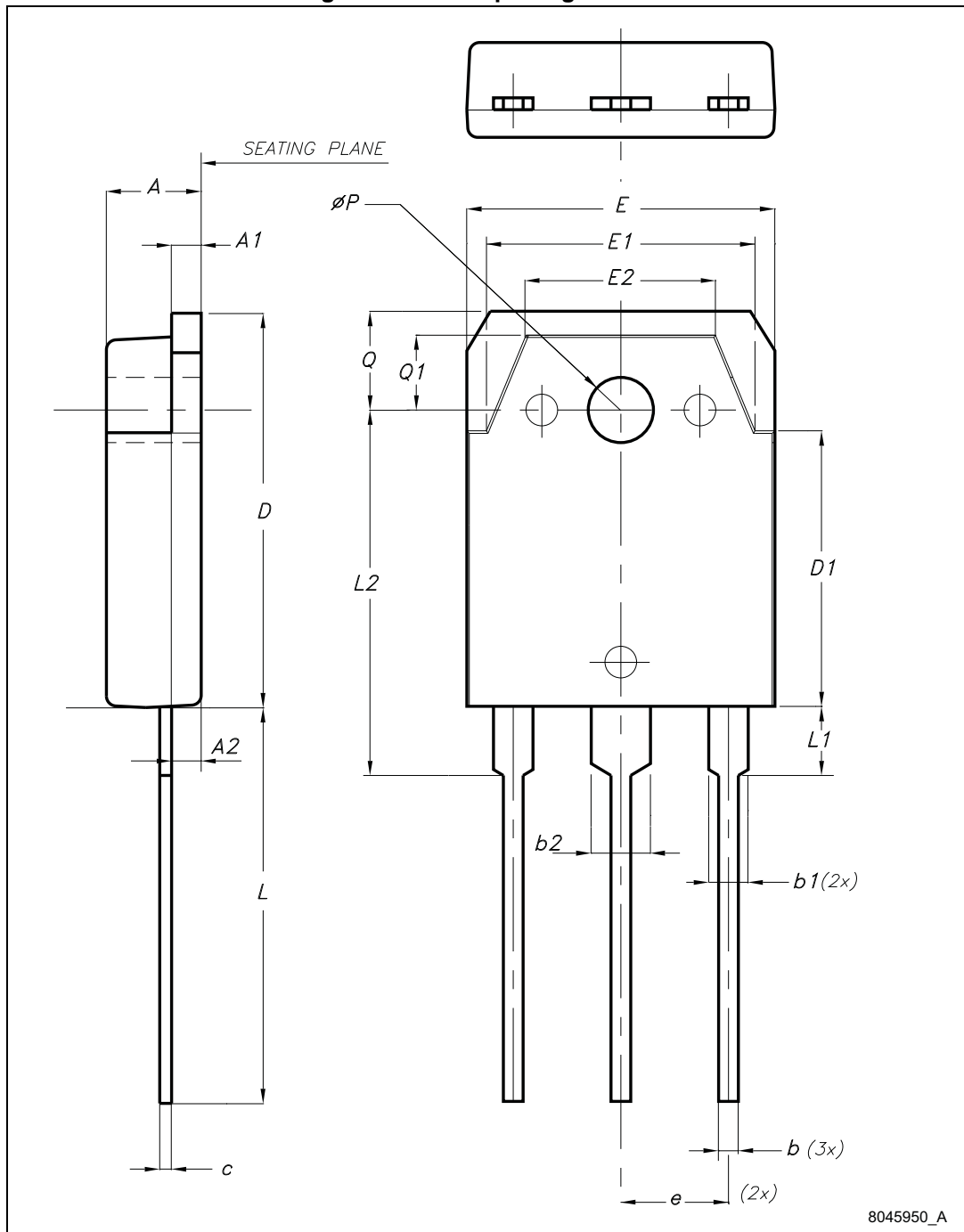

Table 10. TO-3P mechanical data

| Dim. | mm | | |
|------|-------|-------|-------|
| | Min. | Typ. | Max. |
| A | 4.60 | | 5 |
| A1 | 1.45 | 1.50 | 1.65 |
| A2 | 1.20 | 1.40 | 1.60 |
| b | 0.80 | 1 | 1.20 |
| b1 | 1.80 | | 2.20 |
| b2 | 2.80 | | 3.20 |
| c | 0.55 | 0.60 | 0.75 |
| D | 19.70 | 19.90 | 20.10 |
| D1 | | 13.90 | |
| E | 15.40 | | 15.80 |
| E1 | | 13.60 | |
| E2 | | 9.60 | |
| e | 5.15 | 5.45 | 5.75 |
| L | 19.50 | 20 | 20.50 |
| L1 | | 3.50 | |
| L2 | 18.20 | 18.40 | 18.60 |
| øP | 3.10 | | 3.30 |
| Q | | 5 | |
| Q1 | | 3.80 | |

5 Revision history

Table 11. Document revision history

| Date | Revision | Changes |
|-------------|----------|---|
| 15-Jan-2013 | 1 | Initial release. |
| 23-Apr-2013 | 2 | Added: <ul style="list-style-type: none"> – New order code STGWT60V60DF and new package mechanical data TO-3P <i>Table 9 on page 16, Figure 33 on page 15.</i> – <i>Section 2.1: Electrical characteristics (curves) on page 6.</i> |
| 04-Jun-2013 | 3 | Updated <i>Table 4: Static characteristics</i> and <i>Figure 12 on page 7.</i> Document status changed from preliminary to production data. |
| 21-Jun-2013 | 4 | Updated <i>Figure 3: Collector current vs. temperature case.</i> |
| 12-Jul-2013 | 5 | Updated R_{thJC} value for Diode in <i>Table 3: Thermal data.</i> |
| 21-Oct-2013 | 6 | Updated title, features and description in cover page. |
| 28-Sep-2016 | 7 | Added part number STGWA60V60DF and <i>TO-247 long leads package information.</i> Updated <i>Table 2 Table 4</i> and <i>Table 6.</i> Updated <i>Figure 10: Transfer characteristics.</i> Minor text changes. |

IMPORTANT NOTICE – PLEASE READ CAREFULLY

STMicroelectronics NV and its subsidiaries ("ST") reserve the right to make changes, corrections, enhancements, modifications, and improvements to ST products and/or to this document at any time without notice. Purchasers should obtain the latest relevant information on ST products before placing orders. ST products are sold pursuant to ST's terms and conditions of sale in place at the time of order acknowledgement.

Purchasers are solely responsible for the choice, selection, and use of ST products and ST assumes no liability for application assistance or the design of Purchasers' products.

No license, express or implied, to any intellectual property right is granted by ST herein.

Resale of ST products with provisions different from the information set forth herein shall void any warranty granted by ST for such product.

ST and the ST logo are trademarks of ST. All other product or service names are the property of their respective owners.

Information in this document supersedes and replaces information previously supplied in any prior versions of this document.

© 2016 STMicroelectronics – All rights reserved

Mouser Electronics

Authorized Distributor

Click to View Pricing, Inventory, Delivery & Lifecycle Information:

[STMicroelectronics:](#)

[STGW60V60DF](#) [STGWT60V60DF](#) [STGWA60V60DF](#)