

T-29-25

2034

N-Channel Junction Silicon FET

Capacitor Microphone Applications

©2215

Features

- Especially suited for use in audio, telephone capacitor microphones
- Excellent voltage characteristic
- Excellent transient characteristic
- Adoption of FBET process

Absolute Maximum Ratings at Ta=25°C

			unit
Gate to Drain Voltage	V _{GDO}	-20	V
Gate Current	I _G	10	mA
Drain Current	I _D	1	mA
Allowable Power Dissipation	P _D	100	mW
Junction Temperature	T _J	125	°C
Storage Temperature	T _{stg}	-55 to +125	°C

Electrical Characteristics at Ta=25°C

			min	typ	max	unit
Gate to Drain Breakdown Voltage	V _{(BR)GDO} I _G =-100uA		-20			V
Cutoff Voltage	V _{GS(off)} V _{DS} =5V, I _D =1uA		-0.6	-1.5		V
Drain Current	I _{DSS} V _{DS} =5V, V _{GS} =0		100*		800*	uA
Forward Transfer Admittance	Y _{fs} V _{DS} =5V, V _{GS} =0, f=1kHz		0.4	1.2		mS
Input Capacitance	c _{iss} V _{DS} =5V, V _{GS} =0, f=1MHz			3.5		pF
Output Capacitance	c _{rss} V _{DS} =5V, V _{GS} =0, f=1MHz			0.65		pF

*: The 2SK596 is classified by I_{DSS} as follows (unit:uA):

100 A	170	150 B	240	210 C	350	320 D	480	440 E	800
-------	-----	-------	-----	-------	-----	-------	-----	-------	-----

[Ta=25°C, V_{CC}=4.5V, R_L=1kohm, C_{in}=15pF, See specified Test Circuit.]

			min	typ	max	unit
Voltage Gain	G _V V _{in} =10mV, f=1kHz			-3.0		dB
Reduced Voltage Characteristic	ΔG _V V _{in} =10mV, f=1kHz			-1.2	-3.5	dB
Frequency Characteristic	ΔG _{Vf} V _{CC} =4.5→1.5V				-1.0	dB
		f=1kHz to 110Hz				

Continued on next page.

Specified Test Circuit

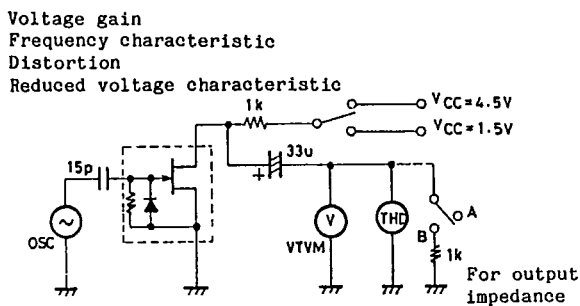

Case Outline 2034 (unit:mm)

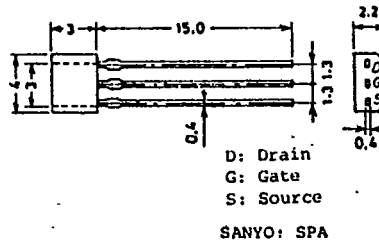

Continued from preceding page.

			min	typ	max	unit
Input Resistance	Z_{in}	$f=1\text{kHz}$		25		Mohm
Output Resistance	Z_o	$f=1\text{kHz}$			700	ohm
Total Harmonic Distortion	THD	$V_{in}=30\text{mV}, f=1\text{kHz}$		1.0		%
Output Noise Voltage	V_{NO}	$V_{in}=0, A \text{ curve}$			-110	dB

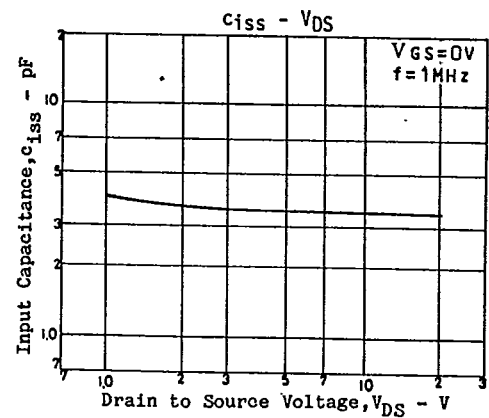
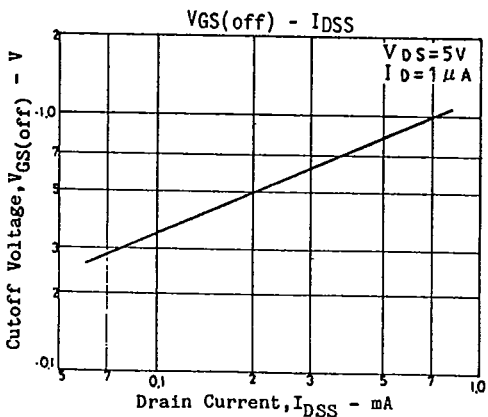
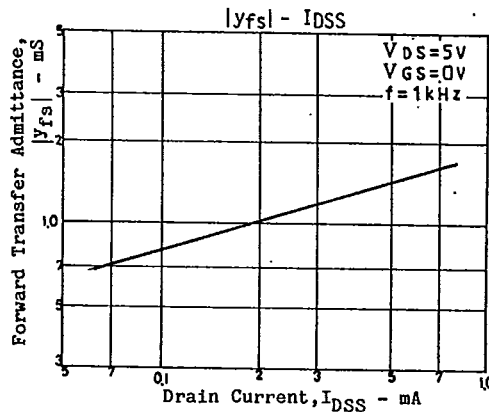
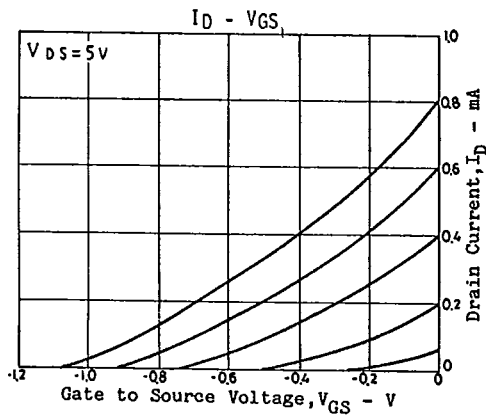
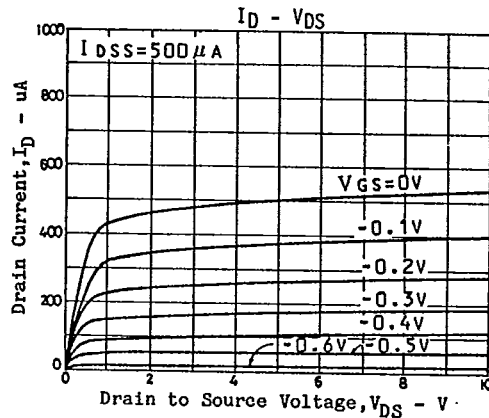
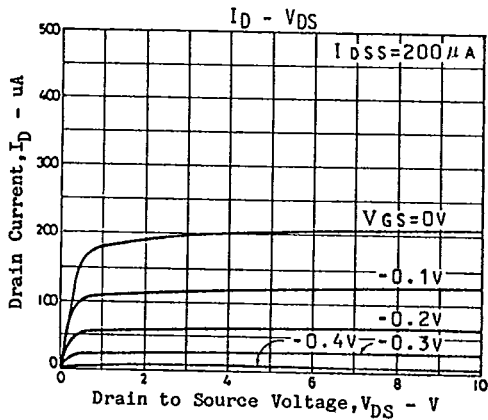

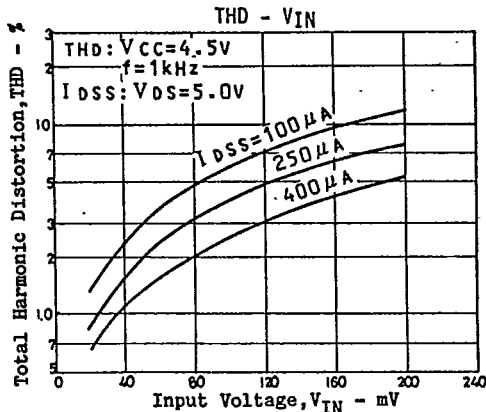
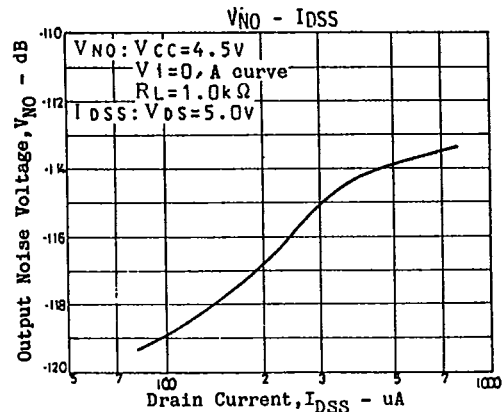
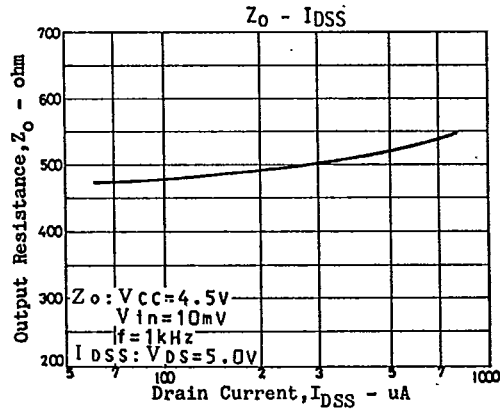
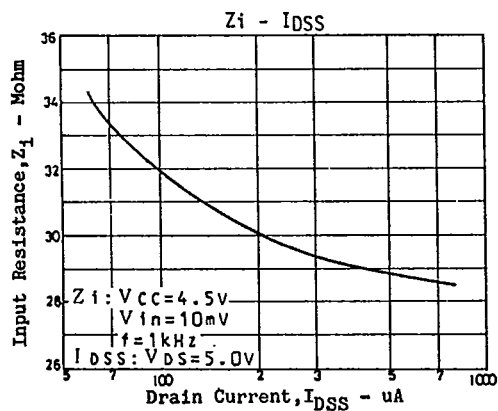
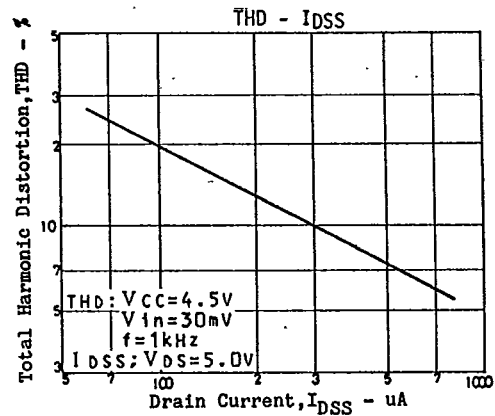
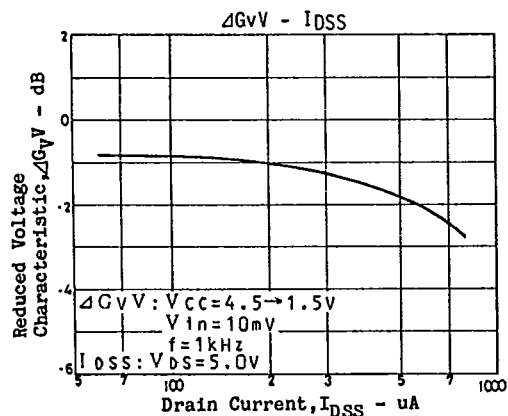
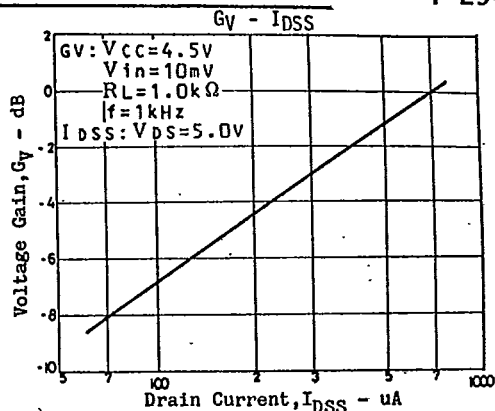
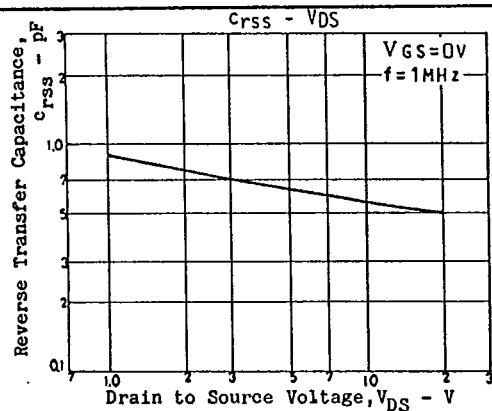

T-29-25

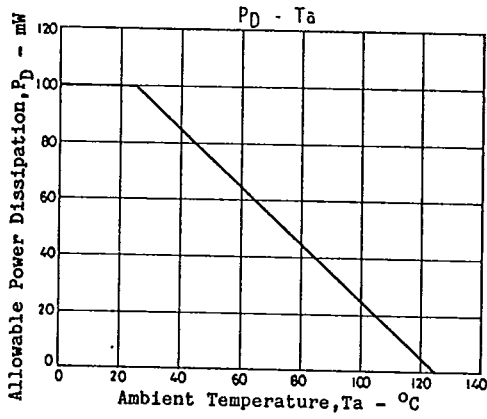

T-91-20

CASE OUTLINES OF LEAD FORMED SMALL SIGNAL TRANSISTORS

- All of Sanyo lead formed small signal transistor case outlines are illustrated below.
- All dimensions are in mm, and dimensions which are not followed by min. or max. are represented by typical values.
- No marking is indicated.

Case Outline-[2003A] unit: mm

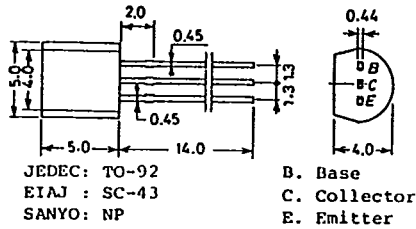

Case Outline-[2019A] unit: mm

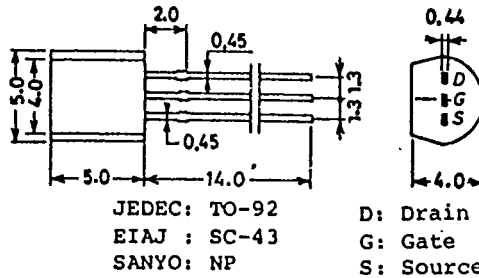

Case Outline-[2004A] unit: mm

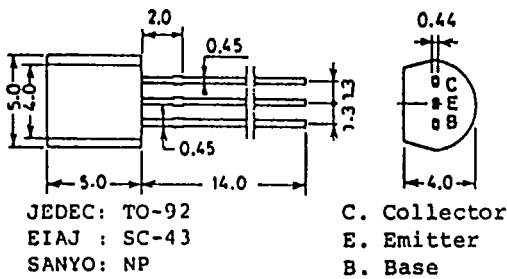

Case Outline-[2025] unit: mm

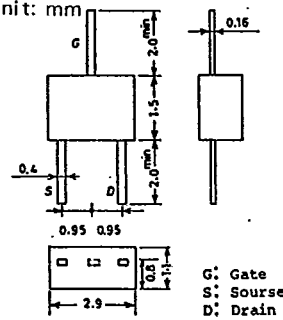

Case Outline-[2005A] unit: mm

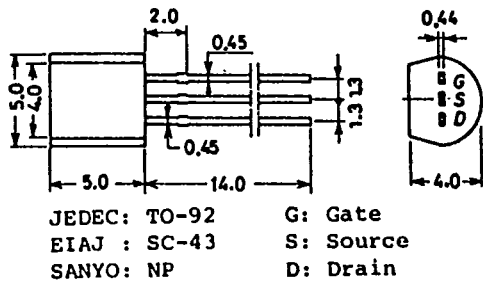

Case Outline-[2026] unit: mm

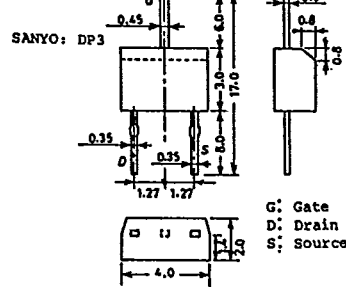

Case Outline-[2006A] unit: mm

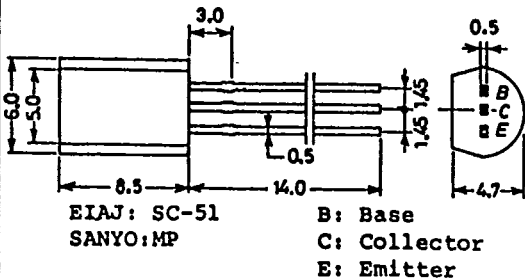

Case Outline-[2027A] unit: mm

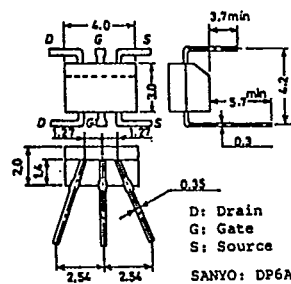

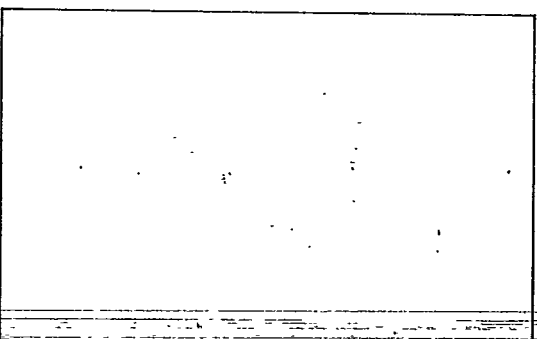
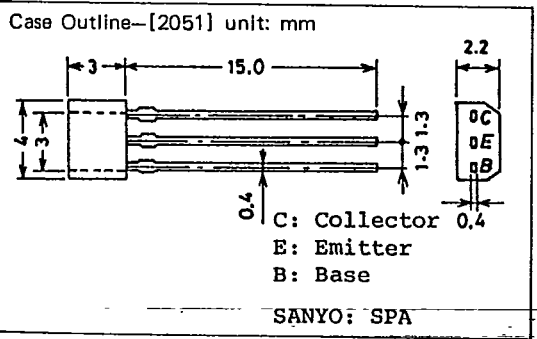
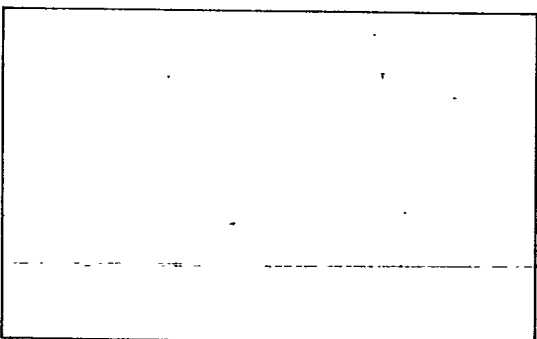
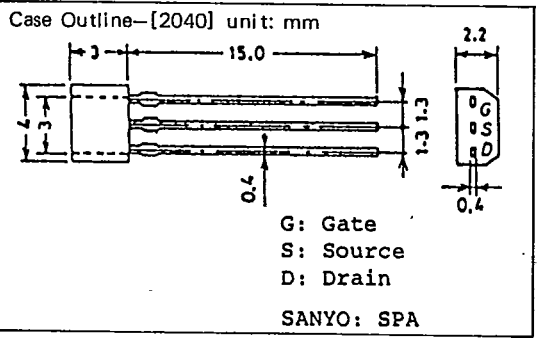
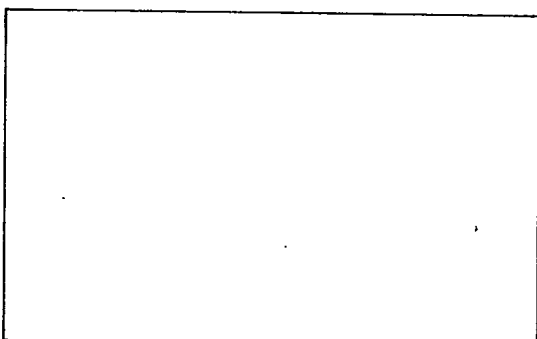
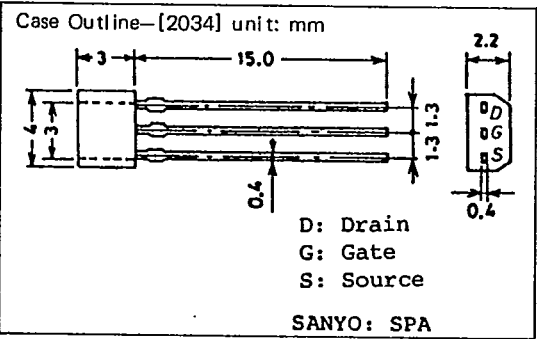
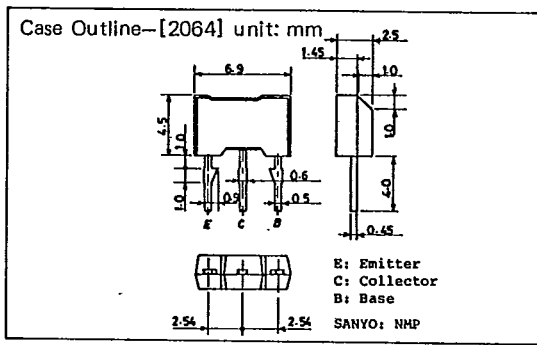
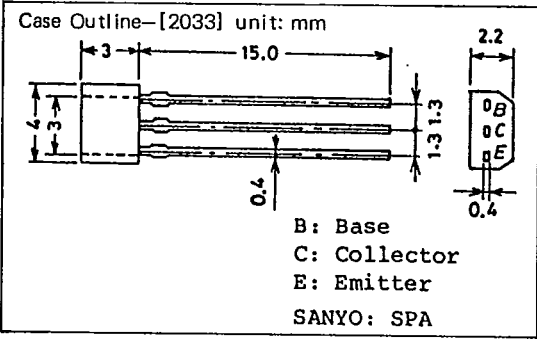
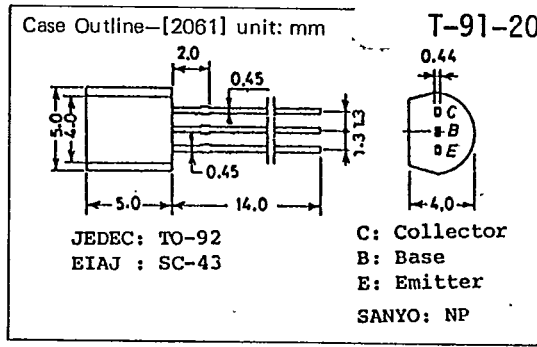
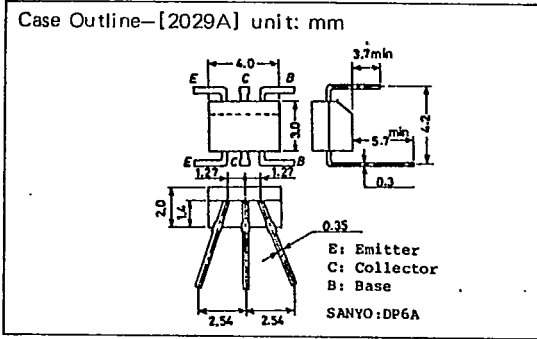

This datasheet has been downloaded from:

www.DatasheetCatalog.com

Datasheets for electronic components.