

High Voltage Switching Transistor (400V, 2A)

2SC3969 / 2SC5161

●Features

- 1) Low $V_{CE(sat)}$.
 $V_{CE(sat)} = 0.15V$ (Typ.)
 $(I_C / I_B = 1A / 0.2A)$
- 2) High breakdown voltage.
 $V_{CEO} = 400V$
- 3) Fast switching.
 $t_r = 1.0\mu s$
 $(I_C = 0.8A)$

●Structure

Three-layer, diffused planar type
 NPN silicon transistor

●External dimensions (Units: mm)

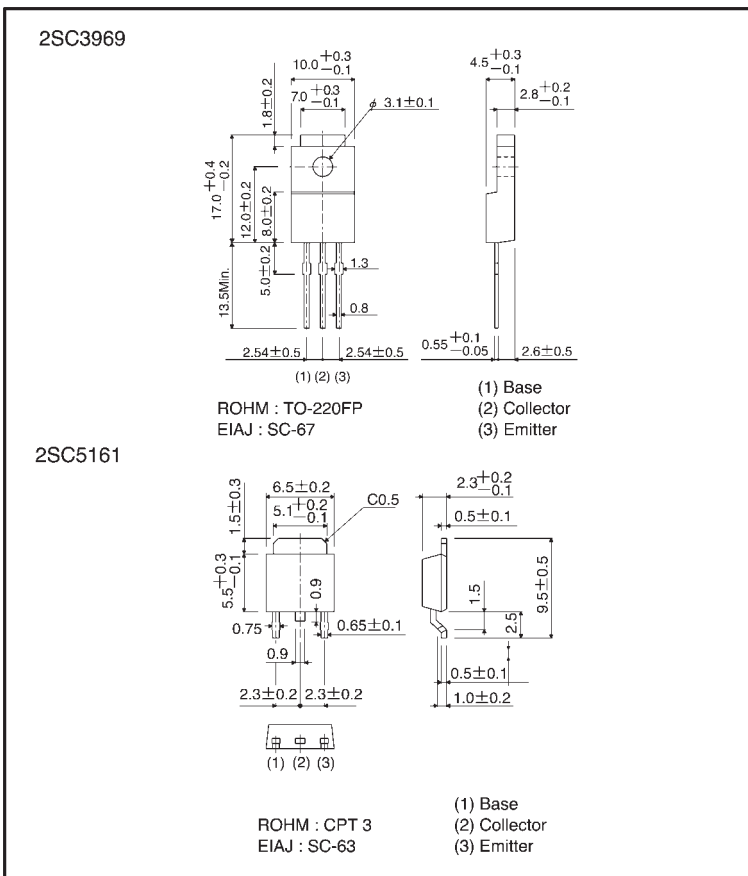

● Absolute maximum ratings (Ta = 25°C)

Parameter		Symbol	Limits	Unit
Collector-base voltage		V _{CB0}	400	V
Collector-emitter voltage		V _{CEO}	400	V
Emitter-base voltage		V _{EB0}	7	V
Collector current		I _C	2	A (DC)
		I _{CP}	4	A (Pulse) *
Collector power dissipation	2SC3969	P _C	2	W
			20	W(T _C =25°C)
	2SC5161		1	W
			10	W(T _C =25°C)
Junction temperature		T _J	150	°C
Storage temperature		T _{stg}	-55~+150	°C

* Single pulse P_w=10ms

● Electrical characteristics (Ta = 25°C)

Parameter	Symbol	Min.	Typ.	Max.	Unit	Conditions
Collector-base breakdown voltage	BV _{CB0}	400	—	—	V	I _C =50 μA
Collector-emitter breakdown voltage	BV _{CEO}	400	—	—	V	I _C =1mA
Collector-emitter voltage	V _{CEO(SUS)}	400	—	—	V	I _C =1.0A, I _{B1} =0.1A, L=1mH *2
Emitter-base breakdown voltage	BV _{EB0}	7	—	—	V	I _E =50 μA
Collector cutoff current	I _{CB0}	—	—	10	μA	V _{CB} =400V
Emitter cutoff current	I _{EB0}	—	—	10	μA	V _{EB} =7V
Collector-emitter saturation voltage	V _{CE(sat)}	—	—	1	V	I _C /I _B =1A/0.2A
Base-emitter saturation voltage	V _{BE(sat)}	—	—	1.5	V	I _C /I _B =1A/0.2A
DC current transfer ratio	h _{FE}	25	—	50	—	V _{CE} =5V, I _C =0.1A
Transition frequency	f _r	—	10	—	MHz	V _{CE} =10V, I _E =-0.1A, f=5MHz *1
Output capacitance	C _{ob}	—	30	—	pF	V _{CB} =10V, I _E =0A, f=1MHz
Turn-on time	t _{ON}	—	—	1	μs	I _C =0.8A, R _L =250 Ω
Storage time	t _{stg}	—	—	2.5	μs	I _{B1} =-I _{B2} =0.08A V _{CC} =200V
Fall time	t _f	—	—	1	μs	Refer to measurement circuit diagram

*1 Measured using pulse current

*2 2SC3969

● Packaging specifications and h_{FE}

Type	h _{FE}	Package name	Bulk	Taping
		Code		TL
		Basic ordering unit (pieces)	500	2500
2SC3969	B		○	—
2SC5161	B		—	○

h_{FE} values are classified as follows :

Item	B
h _{FE}	25~50

●Electrical characteristic curves

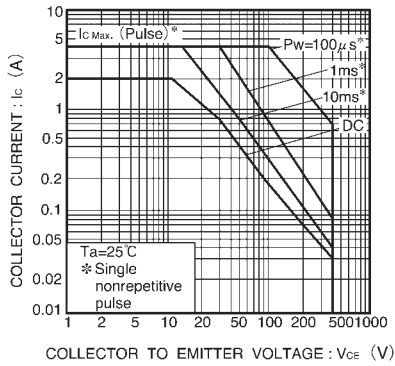

Fig.1 Safe operating area (2SC3969)

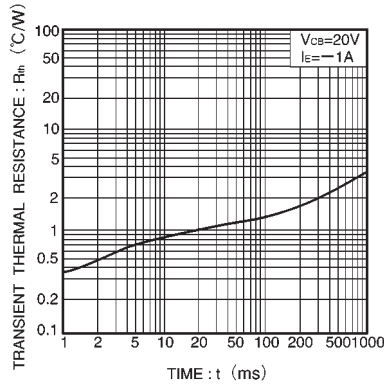

Fig.2 Transient thermal resistance (2SC3969)

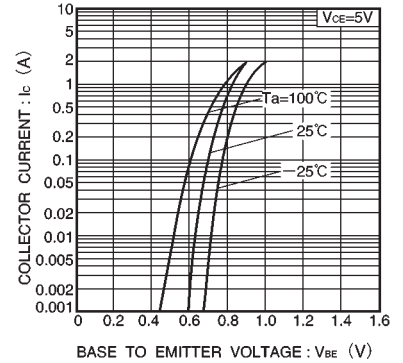

Fig.3 Grounded emitter propagation characteristics

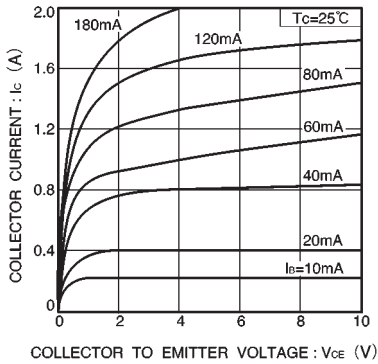

Fig.4 Grounded emitter output characteristics

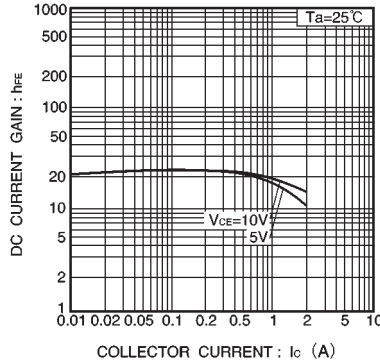

Fig.5 DC current gain vs. collector current (I)

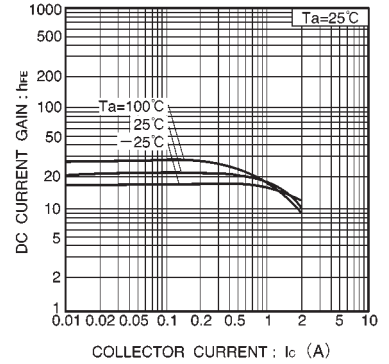

Fig.6 DC current gain vs. collector current (II)

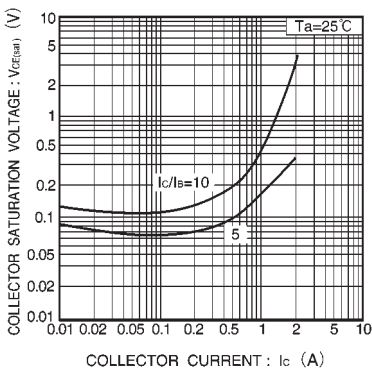

Fig.7 Collector-emitter saturation voltage vs. collector current

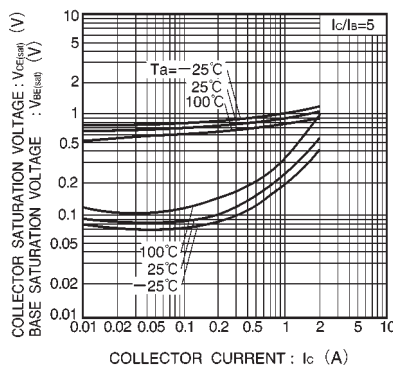

Fig.8 Collector-emitter saturation voltage vs. collector current Base-emitter saturation voltage vs. collector current

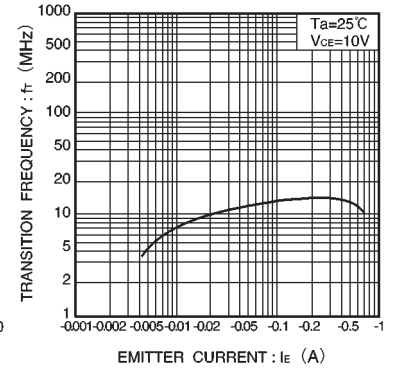

Fig.9 Gain bandwidth product vs. emitter current

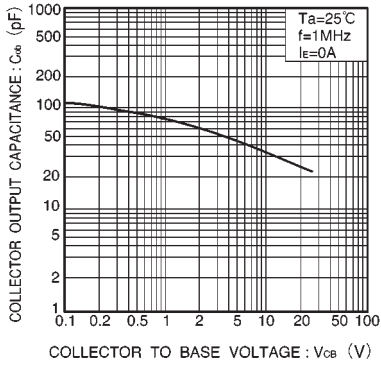

Fig.10 Collector output capacitance vs. collector-base voltage

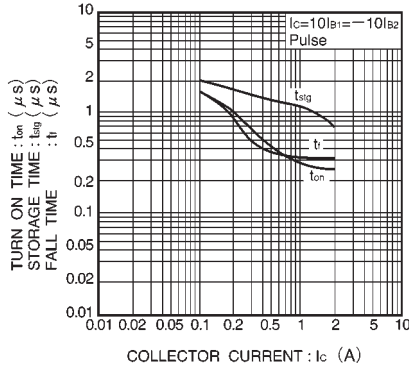

Fig.11 Switching time vs. collector current

● Switching characteristics measurement circuit

