



## NT1193FAAE2S

### GNSS Wideband Low Noise Amplifier

#### FEATURES

- Frequency range: 1164 MHz to 1610 MHz
- Supply voltage: 1.5 V to 3.7 V (2.8 V typ.)
- Low current: 5 mA typ.
- High gain: 21.5 dB typ.@ L1/2/5/6 band
- Low NF: 0.7 dB typ.@ L1/2/5/6 band
- P-1dB(IN): -16 dBm typ.@ L1/2/5/6 band
- With stand-by function
- Small package size: 0.7 x 1.1 mm typ.  
t = 0.39 mm max.
- Operating temperature range: -40 to +105°C
- RoHS compliant and Halogen Free, MSL1

#### GENERAL DESCRIPTION

The NT1193 is a GNSS wideband low noise amplifier (LNA) designed for multi-band GNSS systems.

This LNA features high gain and low noise figure in all GNSS band from L1 to L2/L5/L6, which makes it ideal for GNSS module and IoT device applications. The stand-by function contributes to reduce current consumption.

This LNA features wide operating temperature range from -40 to +105°C.

This LNA achieves compact mounting area by small size package EPFFP-6-FA and only two external components.

#### APPLICATIONS

- GNSS (GPS, GLONASS, Galileo, BeiDou, etc.) receiver applications
- GNSS modules
- Tracking devices
- Drone

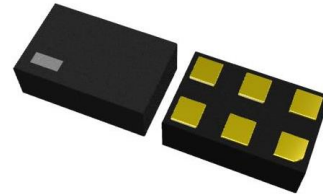

EPFFP-6-FA  
0.7 x 1.1 x 0.39 (mm)

#### BLOCK DIAGRAM

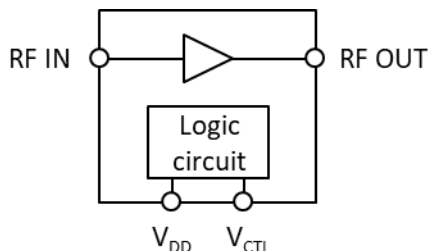

## ■ PRODUCT NAME INFORMATION

**NT1193 FA A E2 S**

Description of configuration

Suffix	Parameter	Description
FA	Package code	Indicates the package. Refer to the order information.
A	Version	Indicates the product version. "A" is initial version.
E2	Packing	Refer to the packing specifications.
S	Grade	Indicates the quality grade. "S" means general-purpose and consumer application. Operating temperature range: -40°C to 105°C, Test temperature: 25°C

## ■ ORDER INFORMATION

PRODUCT NAME	PACKAGE	RoHS	HALOGEN-FREE	PLATING COMPOSITION	WEIGHT (mg)	QUANTITY PER REEL (pcs/reel)
NT1193FAAE2S	EPFFP-6-FA	Yes	Yes	Au	0.7	5000

■ PIN DESCRIPTIONS

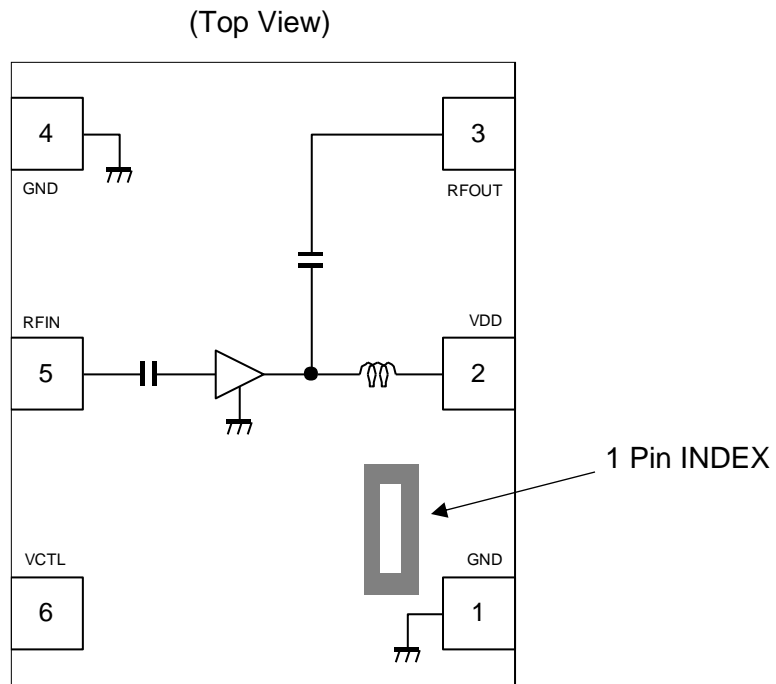

EPFFP-6-FA Pin Configuration

Pin No.	Pin Name	Description
1	GND	Ground terminal
2	VDD	Operating voltage supply terminal
3	RFOUT	RF output terminal
4	GND	Ground terminal
5	RFIN	RF input terminal
6	VCTL	Control signal input terminal

Please refer to "[APPLICATION CIRCUIT](#)" for details.

■ TRUTH TABLE

"H"= $V_{CTL}(H)$ , "L"= $V_{CTL}(L)$

$V_{CTL}$	Mode
H	Active mode
L	Stand-by mode

■ ABSOLUTE MAXIMUM RATINGS

General conditions:  $T_a = +25^{\circ}\text{C}$ ,  $Z_s = Z_l = 50\Omega$

	Symbol	Ratings	Unit
Supply voltage	$V_{DD}$	5.0	V
Control voltage	$V_{CTL}$	5.0	V
Input power	$P_{IN}^{*1}$	+18	dBm
Power dissipation	$P_D^{*2}$	430	mW
Operating temperature range	$T_{opr}$	-40 to +105	$^{\circ}\text{C}$
Storage temperature range	$T_{stg}$	-55 to +150	$^{\circ}\text{C}$

\*1  $V_{DD} = 2.8\text{ V}$

\*2 4-layer FR4 PCB with through-hole (101.5 x 114.5 mm),  $T_j = 150^{\circ}\text{C}$

ABSOLUTE MAXIMUM RATINGS

Electronic and mechanical stress momentarily exceeded absolute maximum ratings may cause permanent damage and may degrade the lifetime and safety for both device and system using the device in the field. The functional operation at or over these absolute maximum ratings is not assured.

\*1 Calculate the power consumption of the IC from the operating conditions and calculate the junction temperature with the thermal resistance.

Please refer to "[THERMAL CHARACTERISTICS](#)" for the thermal resistance under our measurement board conditions.

■ THERMAL CHARACTERISTICS

Parameter	Measurement Result
Thermal Resistance ( $\theta_{ja}$ )	$\theta_{ja} = 290.7\text{ }^{\circ}\text{C/W}$

$\theta_{ja}$ : Junction-to-Ambient Thermal Resistance

■ ELECTROSTATIC DISCHARGE RATINGS

	Conditions	Pin No.	Pin Name	Protection Voltage	
				Ground	VDD
HBM	$C = 100\text{ pF}$ , $R = 1.5\text{ k}\Omega$	1	GND	COM.	$\pm 125\text{ V}$
		2	VDD	$\pm 2000\text{ V}$	COM.
		3	RFOUT	$\pm 2000\text{ V}$	$\pm 2000\text{ V}$
		4	GND	COM.	$\pm 2000\text{ V}$
		5	RFIN	$\pm 2000\text{ V}$	$\pm 2000\text{ V}$
		6	VCTL	$\pm 2000\text{ V}$	$\pm 500\text{ V}$

	Conditions	Protection Voltage
CDM	Field Induced CDM	$\pm 1000\text{ V}$

ELECTROSTATIC DISCHARGE RATINGS

The electrostatic discharge tests are done based on JEDEC JS-001 and JS-002. In the HBM method, ESD is applied using the power supply pin and GND pin as reference pins.

■ RECOMMENDED OPERATING CONDITIONS

	Symbol	Value	Unit
Supply voltage	$V_{DD}$	1.5 to 3.7	V
Control voltage	$V_{CTL}$	1.5 to 3.7	V
Operating temperature range	$T_a$	-40 to +105	°C

RECOMMENDED OPERATING CONDITIONS

All of electronic equipment should be designed that the mounted semiconductor devices operate within the recommended operating conditions. The semiconductor devices cannot operate normally over the recommended operating conditions, even if when they are used over such conditions by momentary electronic noise or surge. And the semiconductor devices may receive serious damage when they continue to operate over the recommended operating conditions.

■ ELECTRICAL CHARACTERISTICS 1 (DC)

General conditions:  $T_a = +25^{\circ}\text{C}$ ,  $Z_s = Z_i = 50\Omega$

Parameter	Symbol	Conditions	MIN	TYP	MAX	Unit
Supply voltage	$V_{DD}$		1.5	2.8	3.7	V
Control voltage (High)	$V_{CTL(H)}$		1.5	1.8	3.7	V
Control voltage (Low)	$V_{CTL(L)}$		0	0	0.3	V
Operating current	$I_{DD}$	RF OFF, $V_{DD} = 2.8\text{ V}$ , $V_{CTL} = 1.8\text{ V}$	-	5	8	mA
		RF OFF, $V_{DD} = 1.8\text{ V}$ , $V_{CTL} = 1.8\text{ V}$	-	4.4	7	mA
		RF OFF, $V_{DD} = 2.8\text{ V}$ , $V_{CTL} = 0\text{ V}$	-	0.1	3	$\mu\text{A}$
		RF OFF, $V_{DD} = 1.8\text{ V}$ , $V_{CTL} = 0\text{ V}$	-	0.1	3	$\mu\text{A}$
Control current	$I_{CTL}$	RF OFF, $V_{CTL} = 1.8\text{ V}$	-	5	20	$\mu\text{A}$

■ ELECTRICAL CHARACTERISTICS 2 (RF)

General conditions:  $V_{DD} = 2.8\text{ V}$ ,  $V_{CTL} = 1.8\text{ V}$ ,  $f = 1164\text{ MHz to }1610\text{ MHz}$ ,  $T_a = +25^\circ\text{C}$ ,  $Z_s = Z_l = 50\Omega$ , with application circuit

Parameter	Symbol	Conditions	MIN	TYP	MAX	Unit
Small signal gain	Gain	f = 1176 MHz (L5 band), Exclude PCB, connector loss (0.16 dB)	18	21.5	-	dB
		f = 1227 MHz (L2 band), Exclude PCB, connector loss (0.16 dB)				
		f = 1278 MHz (L6 band), Exclude PCB, connector loss (0.17 dB)				
		f = 1575 MHz (L1 band), Exclude PCB, connector loss (0.21 dB)				
Noise figure	NF	f = 1176 MHz (L5 band), Exclude PCB, connector loss (0.07 dB)	-	0.7	1.0	dB
		f = 1227 MHz (L2 band), Exclude PCB, connector loss (0.07 dB)				
		f = 1278 MHz (L6 band), Exclude PCB, connector loss (0.07 dB)				
		f = 1575 MHz (L1 band), Exclude PCB, connector loss (0.09 dB)				
Isolation	ISL	f = 1176 MHz (L5 band)	30	33	-	dB
		f = 1227 MHz (L2 band)				
		f = 1278 MHz (L6 band)				
		f = 1575 MHz (L1 band)				
Input power at 1 dB gain compression point	P-1dB(IN)	f = 1176 MHz (L5 band)	-21	-16	-	dBm
		f = 1227 MHz (L2 band)				
		f = 1278 MHz (L6 band)				
		f = 1575 MHz (L1 band)				
Input 3rd order intercept point	IIP3	f1 = 1176 MHz, f2 = f1 + 1 MHz, P <sub>IN</sub> = -30 dBm	-11	-5	-	dBm
		f1 = 1227 MHz, f2 = f1 + 1 MHz, P <sub>IN</sub> = -30 dBm				
		f1 = 1278 MHz, f2 = f1 + 1 MHz, P <sub>IN</sub> = -30 dBm				
		f1 = 1575 MHz, f2 = f1 + 1 MHz, P <sub>IN</sub> = -30 dBm				
Out of band input power at 1 dB gain compression point	P-1dB(IN)_OB	f <sub>jam</sub> = 1850 MHz, f <sub>RF</sub> = 1176 MHz at P <sub>IN</sub> = -30 dBm	-23	-17	-	dBm
		f <sub>jam</sub> = 1850 MHz, f <sub>RF</sub> = 1227 MHz at P <sub>IN</sub> = -30 dBm				
		f <sub>jam</sub> = 1850 MHz, f <sub>RF</sub> = 1278 MHz at P <sub>IN</sub> = -30 dBm				
		f <sub>jam</sub> = 1850 MHz, f <sub>RF</sub> = 1575 MHz at P <sub>IN</sub> = -30 dBm				
Out of band input 3rd order intercept point	IIP3_OB	f1 = 1785 MHz, f2 = 2401 MHz, P <sub>IN</sub> = -20 dBm, f <sub>meas</sub> = 1169 MHz	-13	-8	-	dBm
		f1 = 1713 MHz, f2 = 1850 MHz, P <sub>IN</sub> = -20 dBm, f <sub>meas</sub> = 1576 MHz				
RFIN Return loss	RLi	f = 1176 MHz (L5 band)	9	13	-	dB
		f = 1227 MHz (L2 band)				
		f = 1278 MHz (L6 band)				
		f = 1575 MHz (L1 band)				
RFOUT Return loss	RLo	f = 1176 MHz (L5 band)	10	16	-	dB
		f = 1227 MHz (L2 band)				
		f = 1278 MHz (L6 band)				
		f = 1575 MHz (L1 band)				
k factor	k	f = 50 MHz to 10 GHz	1	-	-	-

■ ELECTRICAL CHARACTERISTICS 3 (RF)

General conditions:  $V_{DD} = 1.8\text{ V}$ ,  $V_{CTL} = 1.8\text{ V}$ ,  $f = 1164\text{ MHz to }1610\text{ MHz}$ ,  $T_a = +25^\circ\text{C}$ ,  $Z_s = Z_l = 50\Omega$ , with application circuit

Parameter	Symbol	Conditions	MIN	TYP	MAX	Unit
Small signal gain	Gain	f = 1176 MHz (L5 band), Exclude PCB, connector loss (0.16 dB)	17	21	-	dB
		f = 1227 MHz (L2 band), Exclude PCB, connector loss (0.16 dB)				
		f = 1278 MHz (L6 band), Exclude PCB, connector loss (0.17 dB)				
		f = 1575 MHz (L1 band), Exclude PCB, connector loss (0.21 dB)				
Noise figure	NF	f = 1176 MHz (L5 band), Exclude PCB, connector loss (0.07 dB)	-	0.75	1.1	dB
		f = 1227 MHz (L2 band), Exclude PCB, connector loss (0.07 dB)				
		f = 1278 MHz (L6 band), Exclude PCB, connector loss (0.07 dB)				
		f = 1575 MHz (L1 band), Exclude PCB, connector loss (0.09 dB)				
Isolation	ISL	f = 1176 MHz (L5 band)	29	32	-	dB
		f = 1227 MHz (L2 band)				
		f = 1278 MHz (L6 band)				
		f = 1575 MHz (L1 band)				
Input power at 1 dB gain compression point	P-1dB(IN)	f = 1176 MHz (L5 band)	-25	-19	-	dBm
		f = 1227 MHz (L2 band)				
		f = 1278 MHz (L6 band)				
		f = 1575 MHz (L1 band)				
Input 3rd order intercept point	IIP3	f1 = 1176 MHz, f2 = f1 + 1 MHz, P <sub>IN</sub> = -30 dBm	-14	-8	-	dBm
		f1 = 1227 MHz, f2 = f1 + 1 MHz, P <sub>IN</sub> = -30 dBm				
		f1 = 1278 MHz, f2 = f1 + 1 MHz, P <sub>IN</sub> = -30 dBm				
		f1 = 1575 MHz, f2 = f1 + 1 MHz, P <sub>IN</sub> = -30 dBm				
Out of band input power at 1 dB gain compression point	P-1dB(IN)_OB	f <sub>jam</sub> = 1850 MHz, f <sub>RF</sub> = 1176 MHz at P <sub>IN</sub> = -30 dBm	-27	-21	-	dBm
		f <sub>jam</sub> = 1850 MHz, f <sub>RF</sub> = 1227 MHz at P <sub>IN</sub> = -30 dBm				
		f <sub>jam</sub> = 1850 MHz, f <sub>RF</sub> = 1278 MHz at P <sub>IN</sub> = -30 dBm				
		f <sub>jam</sub> = 1850 MHz, f <sub>RF</sub> = 1575 MHz at P <sub>IN</sub> = -30 dBm				
Out of band input 3rd order intercept point	IIP3_OB	f1 = 1785 MHz, f2 = 2401 MHz, P <sub>IN</sub> = -20 dBm, f <sub>meas</sub> = 1169 MHz	-15	-10	-	dBm
		f1 = 1713 MHz, f2 = 1850 MHz, P <sub>IN</sub> = -20 dBm, f <sub>meas</sub> = 1576 MHz				
RFIN Return loss	RLi	f = 1176 MHz (L5 band)	9	13	-	dB
		f = 1227 MHz (L2 band)				
		f = 1278 MHz (L6 band)				
		f = 1575 MHz (L1 band)				
RFOUT Return loss	RLo	f = 1176 MHz (L5 band)	10	18	-	dB
		f = 1227 MHz (L2 band)				
		f = 1278 MHz (L6 band)				
		f = 1575 MHz (L1 band)				
k factor	k	f = 50 MHz to 10 GHz	1	-	-	-

■ TYPICAL CHARACTERISTICS

General conditions:  $V_{DD} = 2.8\text{ V}$ ,  $V_{CTL} = 1.8\text{ V}$ ,  $T_a = +25^\circ\text{C}$ ,  $Z_s = Z_l = 50\Omega$ , with application circuit  
 (Typical Characteristics are intended to be used as reference data; they are not guaranteed.)

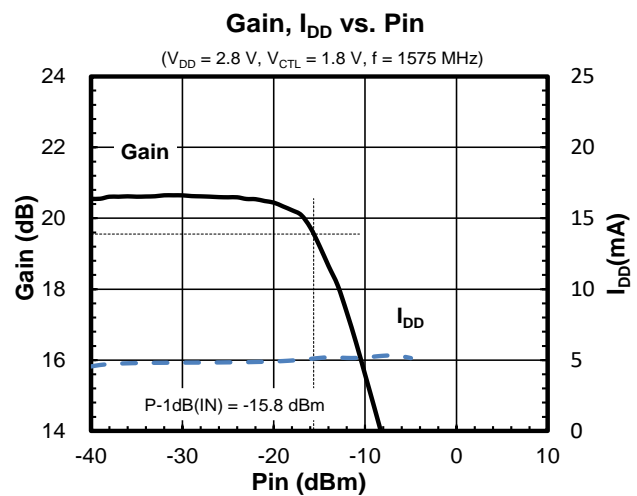
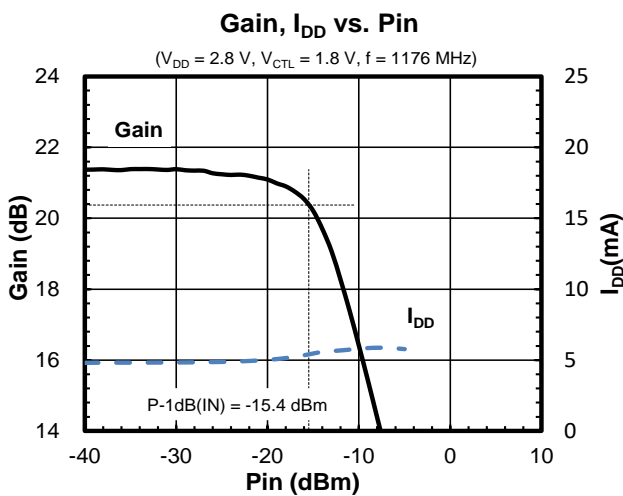
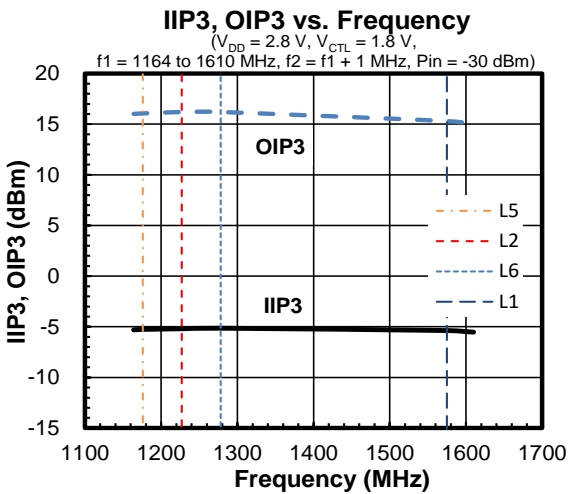
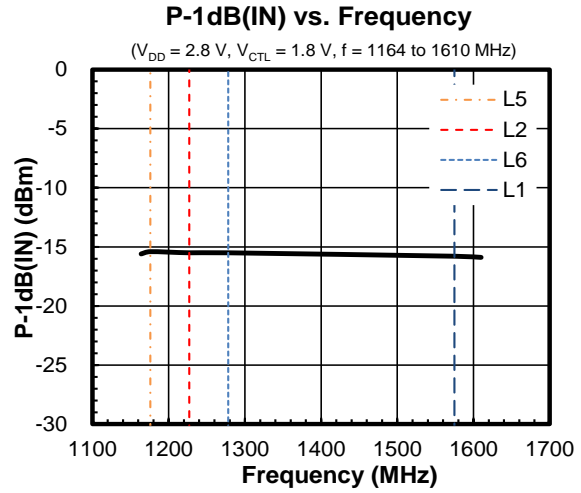
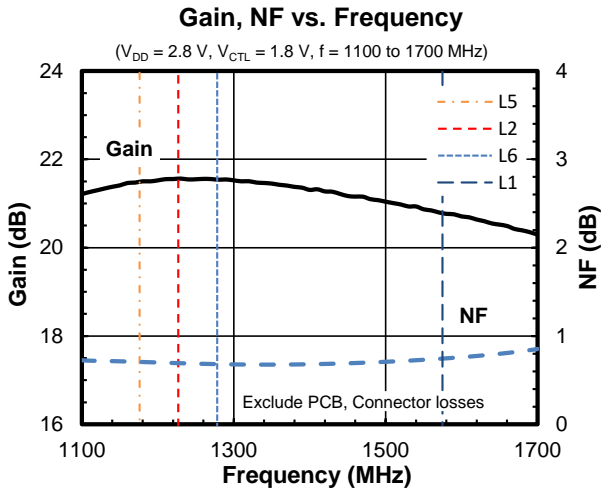



■ TYPICAL CHARACTERISTICS

General conditions:  $V_{DD} = 2.8\text{ V}$ ,  $V_{CTL} = 1.8\text{ V}$ ,  $T_a = +25^\circ\text{C}$ ,  $Z_s = Z_l = 50\Omega$ , with application circuit  
 (Typical Characteristics are intended to be used as reference data; they are not guaranteed.)

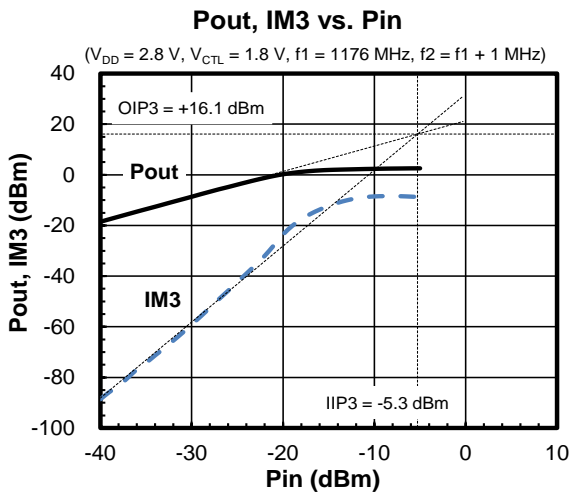
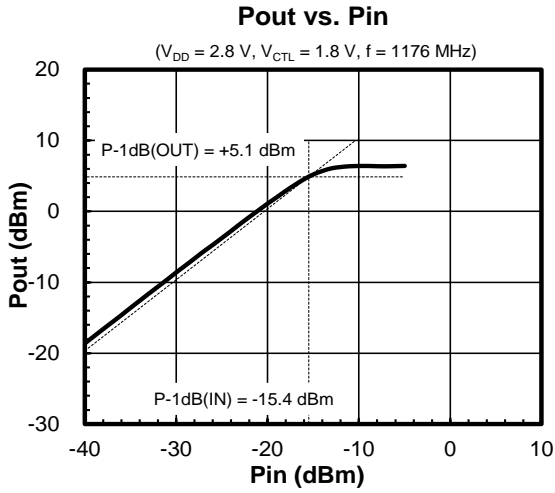

■ TYPICAL CHARACTERISTICS

General conditions:  $V_{DD} = 2.8\text{ V}$ ,  $V_{CTL} = 1.8\text{ V}$ ,  $T_a = +25^\circ\text{C}$ ,  $Z_s = Z_l = 50\Omega$ , with application circuit  
(Typical Characteristics are intended to be used as reference data; they are not guaranteed.)

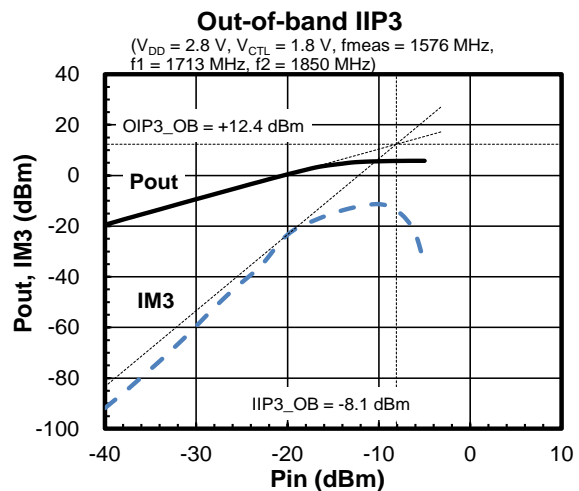
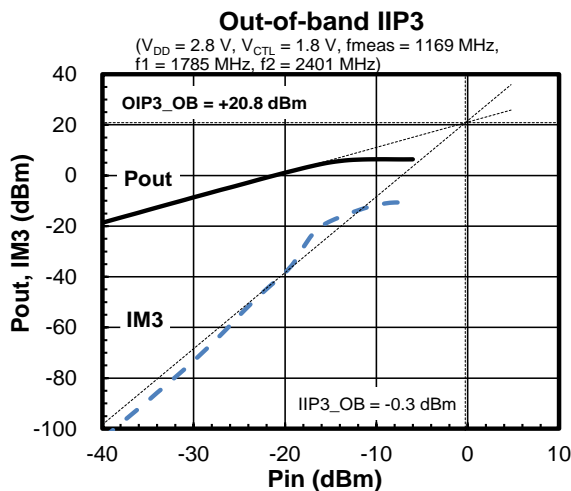
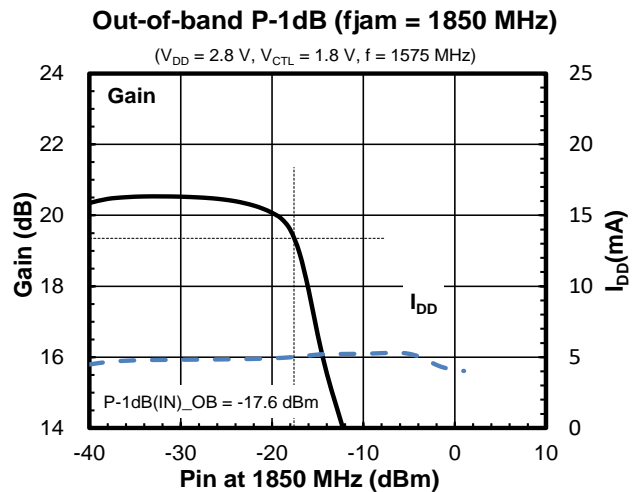
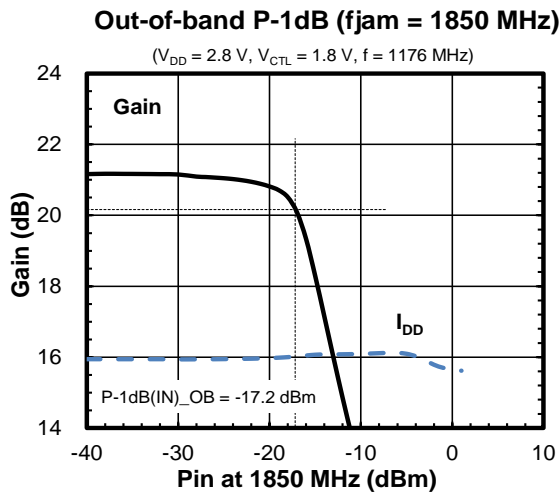
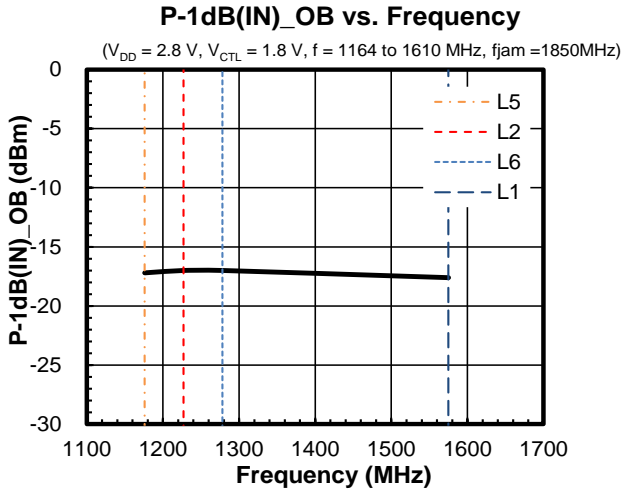

■ TYPICAL CHARACTERISTICS

General conditions:  $V_{DD} = 2.8\text{ V}$ ,  $V_{CTL} = 1.8\text{ V}$ ,  $T_a = +25^\circ\text{C}$ ,  $Z_s = Z_l = 50\Omega$ , with application circuit  
 (Typical Characteristics are intended to be used as reference data; they are not guaranteed.)

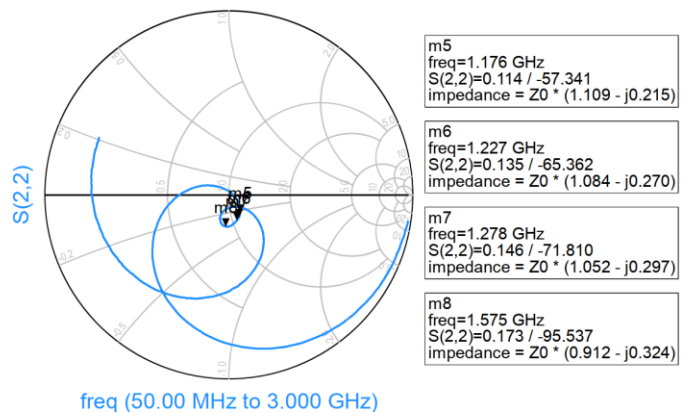
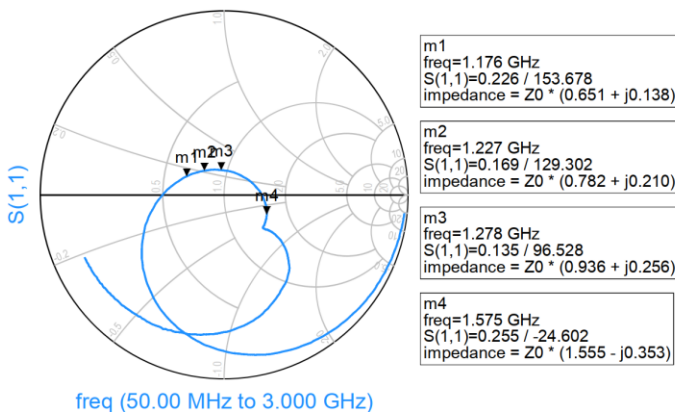
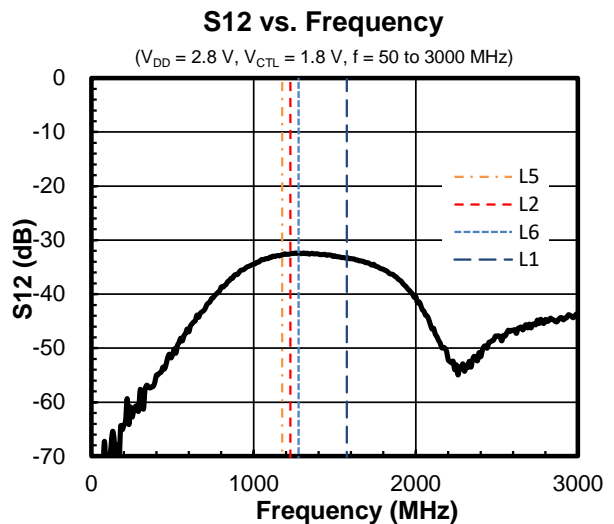
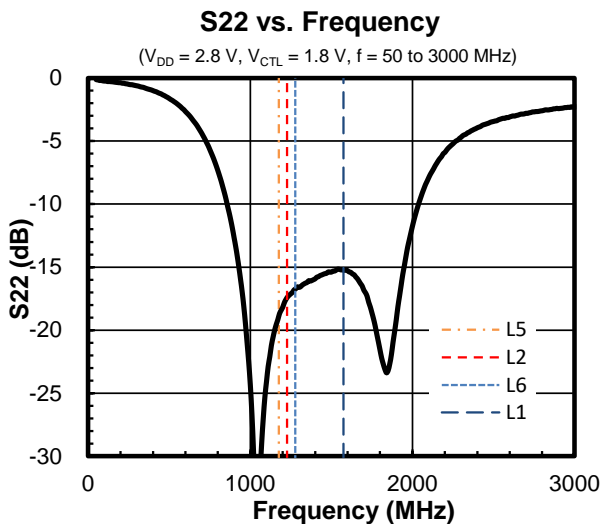
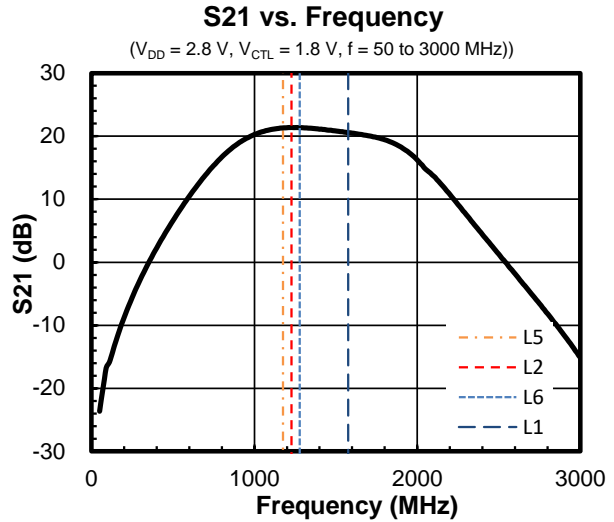
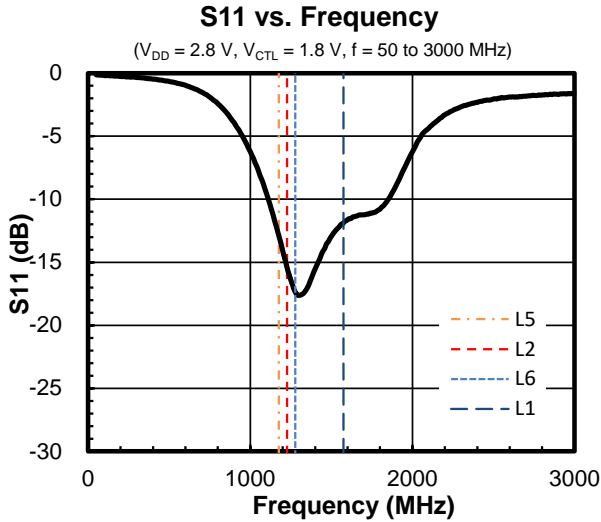

■ TYPICAL CHARACTERISTICS

General conditions:  $V_{DD} = 2.8\text{ V}$ ,  $V_{CTL} = 1.8\text{ V}$ ,  $T_a = +25^\circ\text{C}$ ,  $Z_s = Z_l = 50\Omega$ , with application circuit  
 (Typical Characteristics are intended to be used as reference data; they are not guaranteed.)

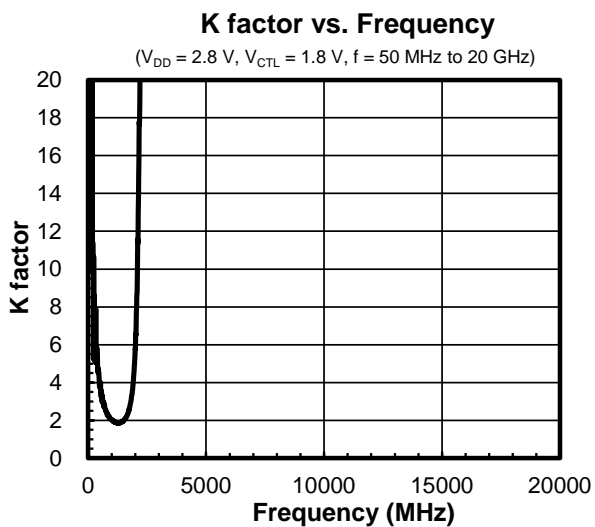
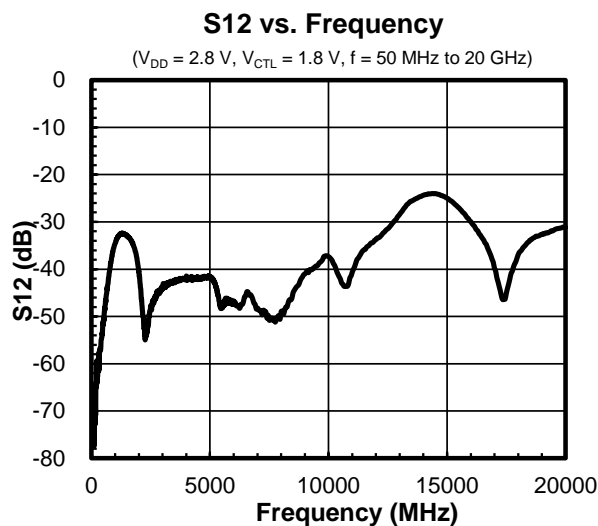
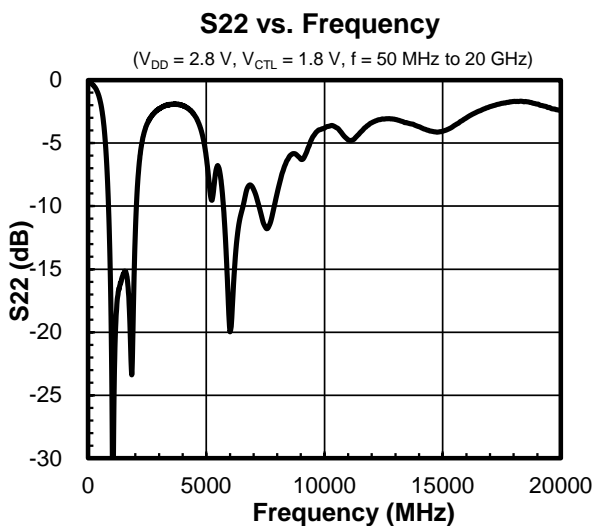
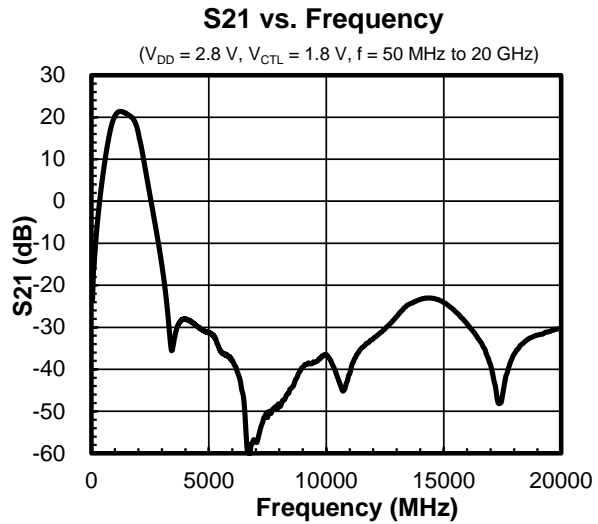
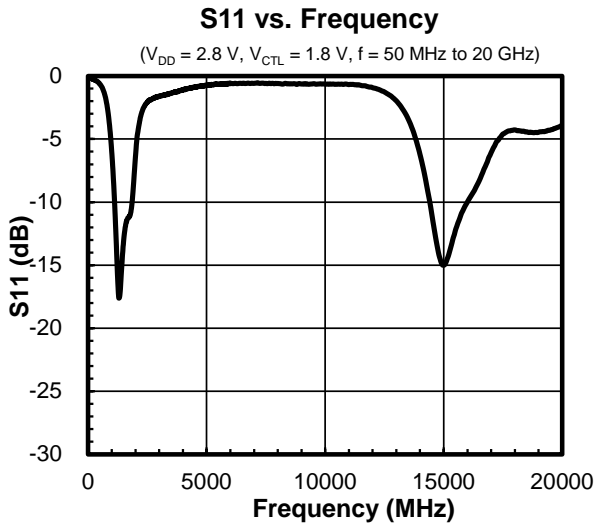

■ TYPICAL CHARACTERISTICS

General conditions:  $V_{DD} = 1.8\text{ V}$ ,  $V_{CTL} = 1.8\text{ V}$ ,  $T_a = +25^\circ\text{C}$ ,  $Z_s = Z_l = 50\Omega$ , with application circuit  
 (Typical Characteristics are intended to be used as reference data; they are not guaranteed.)

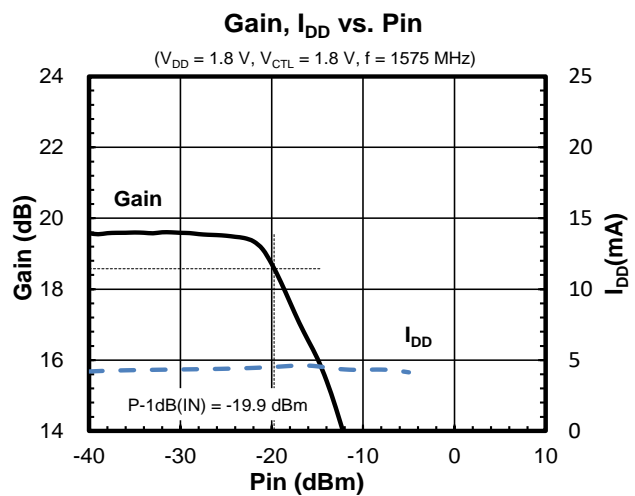
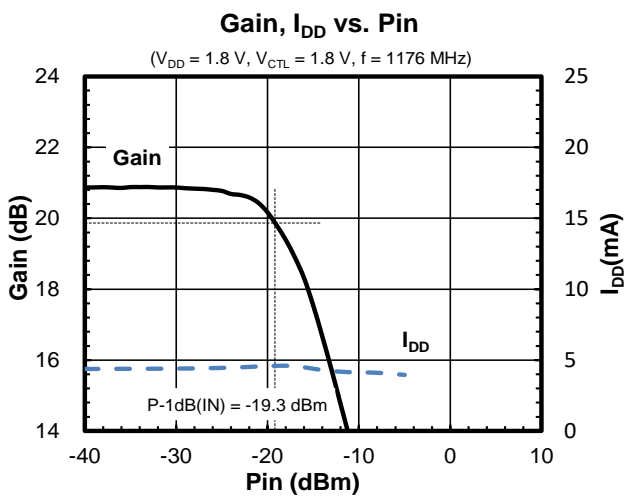
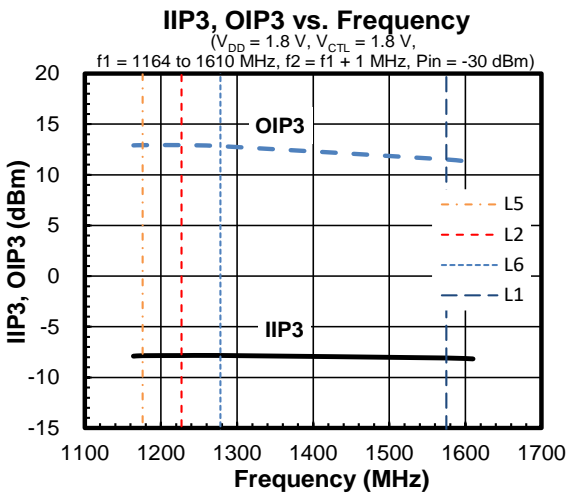
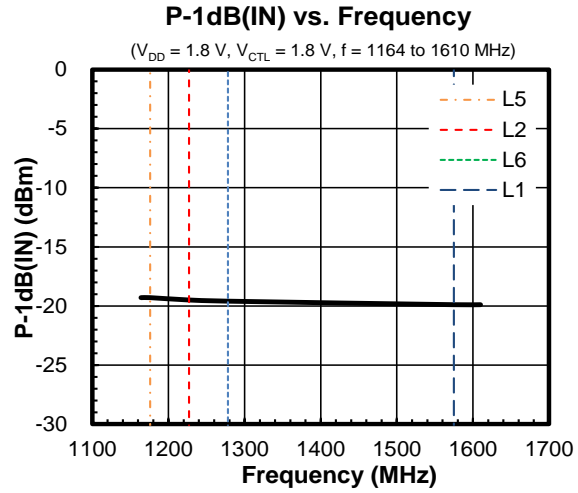
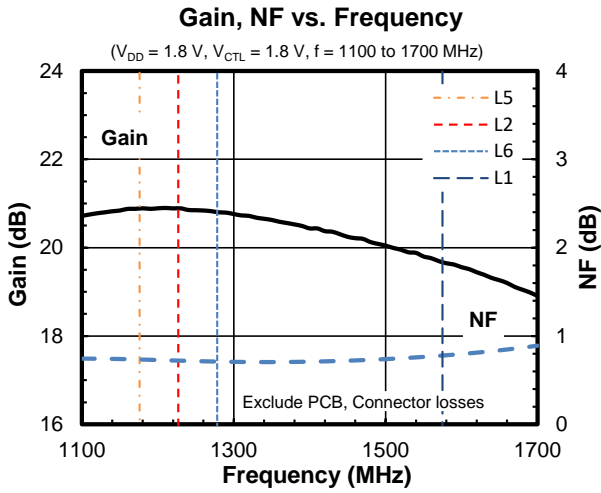

■ TYPICAL CHARACTERISTICS

General conditions:  $V_{DD} = 1.8\text{ V}$ ,  $V_{CTL} = 1.8\text{ V}$ ,  $T_a = +25^\circ\text{C}$ ,  $Z_s = Z_l = 50\Omega$ , with application circuit  
 (Typical Characteristics are intended to be used as reference data; they are not guaranteed.)

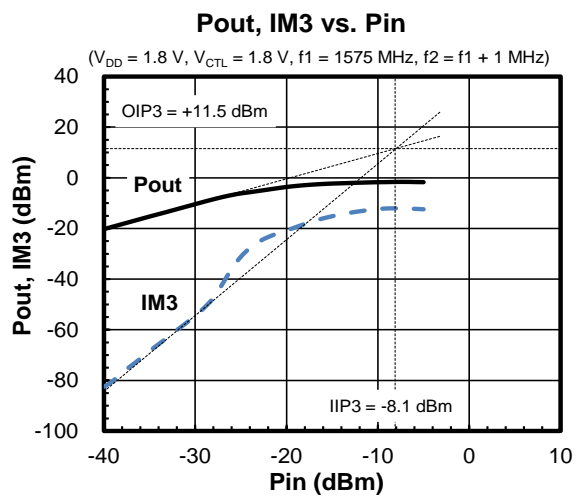
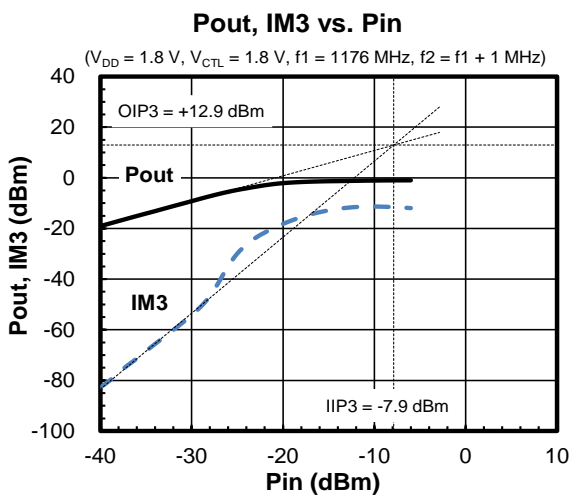
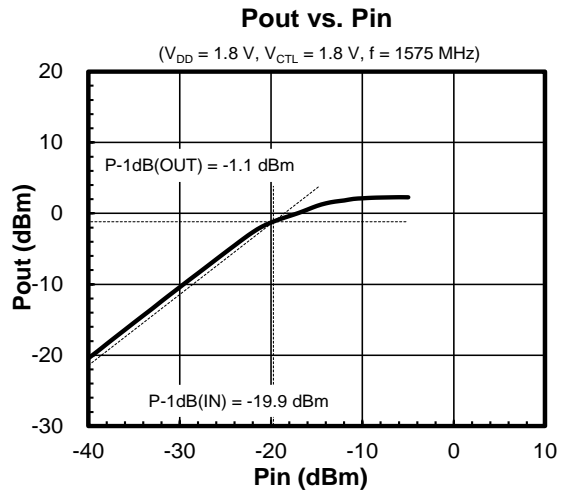
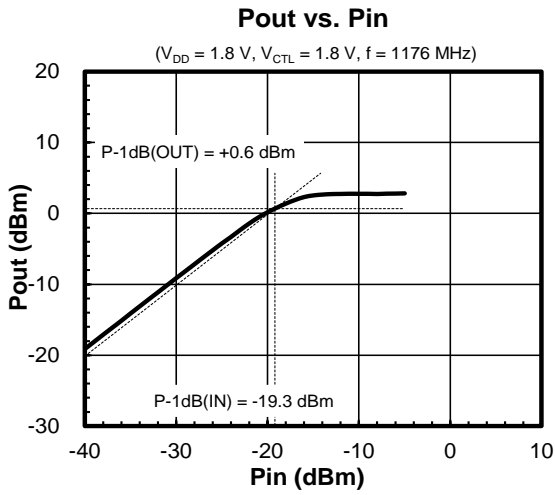

■ TYPICAL CHARACTERISTICS

General conditions:  $V_{DD} = 1.8\text{ V}$ ,  $V_{CTL} = 1.8\text{ V}$ ,  $T_a = +25^\circ\text{C}$ ,  $Z_s = Z_l = 50\Omega$ , with application circuit  
 (Typical Characteristics are intended to be used as reference data; they are not guaranteed.)

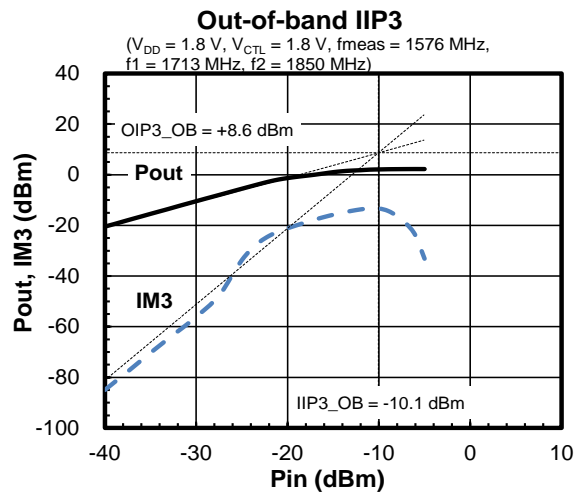
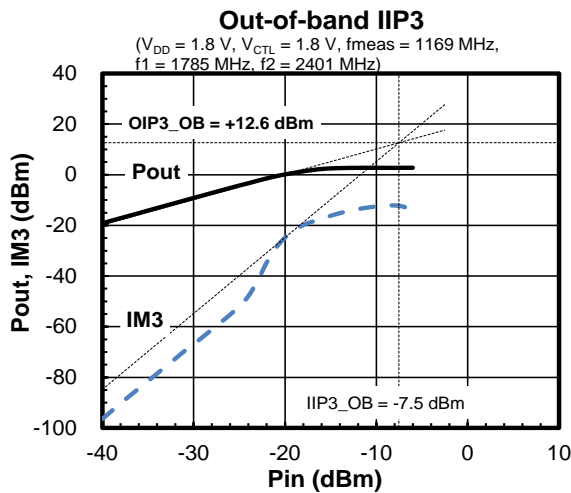
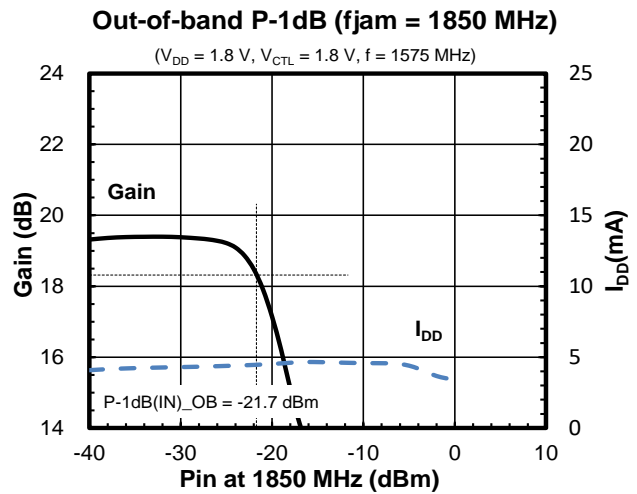
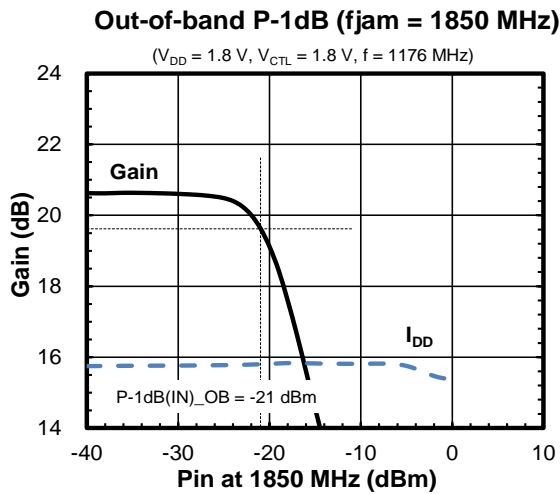
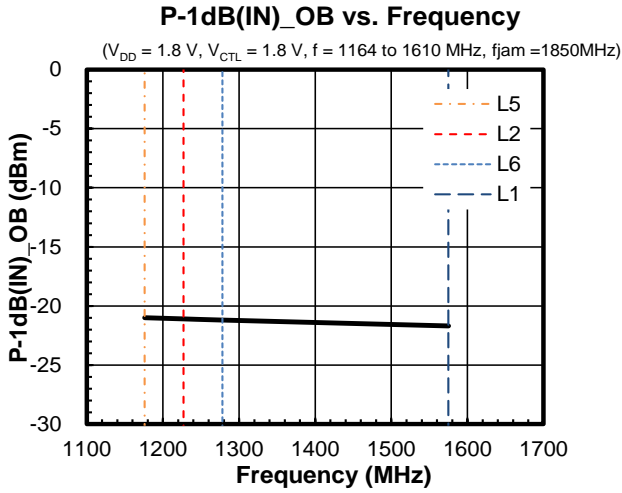

■ TYPICAL CHARACTERISTICS

General conditions:  $V_{DD} = 1.8\text{ V}$ ,  $V_{CTL} = 1.8\text{ V}$ ,  $T_a = +25^\circ\text{C}$ ,  $Z_s = Z_l = 50\Omega$ , with application circuit  
 (Typical Characteristics are intended to be used as reference data; they are not guaranteed.)

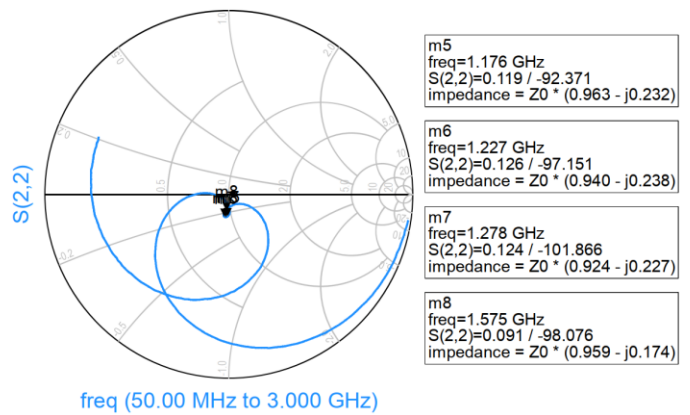
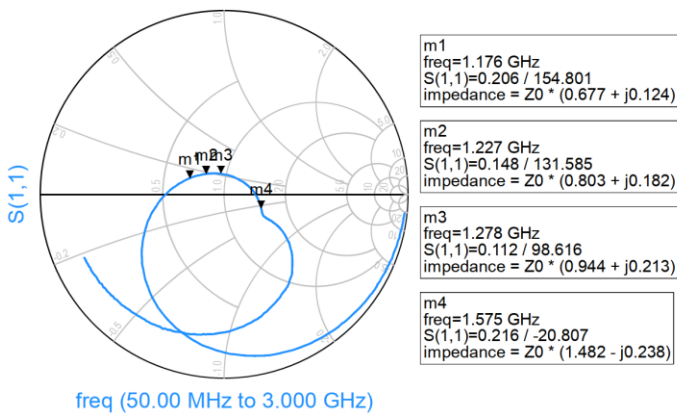
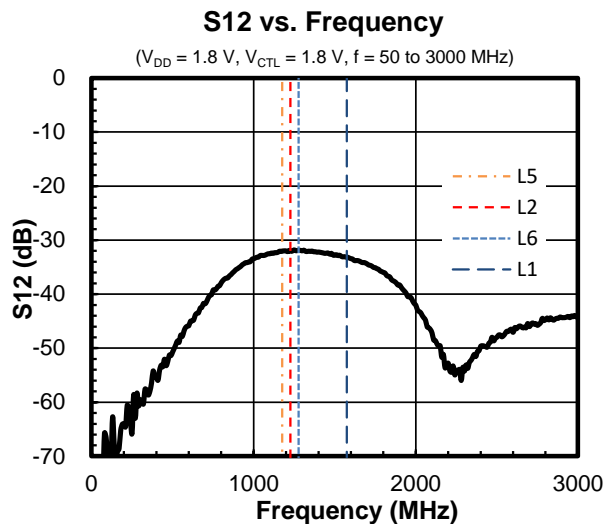
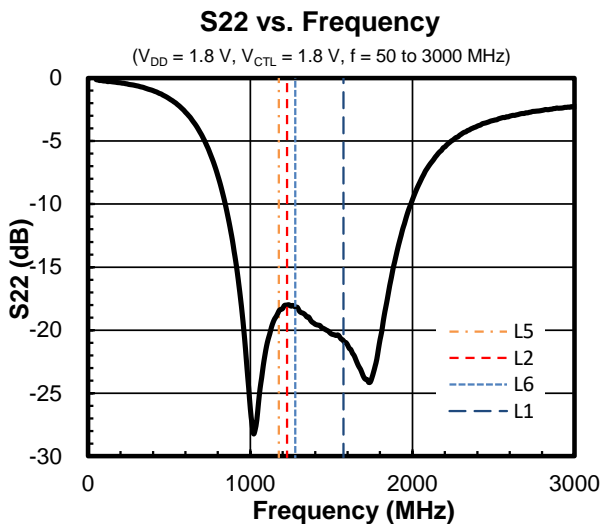
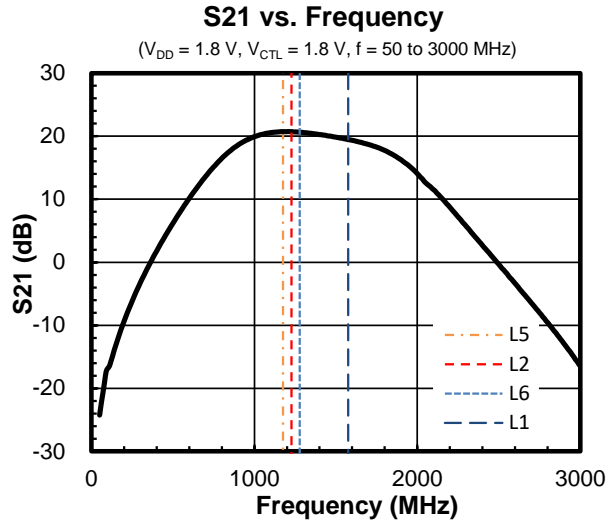
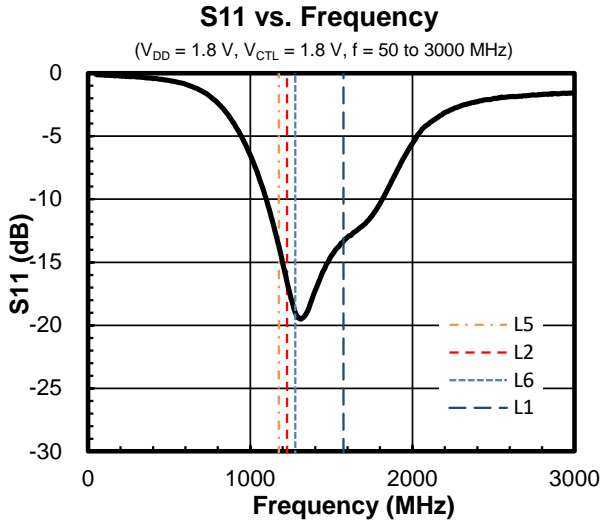



■ TYPICAL CHARACTERISTICS

General conditions:  $V_{DD} = 1.8\text{ V}$ ,  $V_{CTL} = 1.8\text{ V}$ ,  $T_a = +25^\circ\text{C}$ ,  $Z_s = Z_l = 50\Omega$ , with application circuit  
 (Typical Characteristics are intended to be used as reference data; they are not guaranteed.)

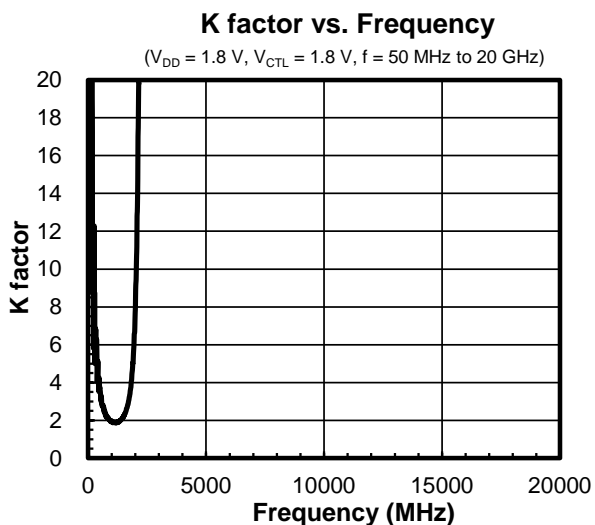
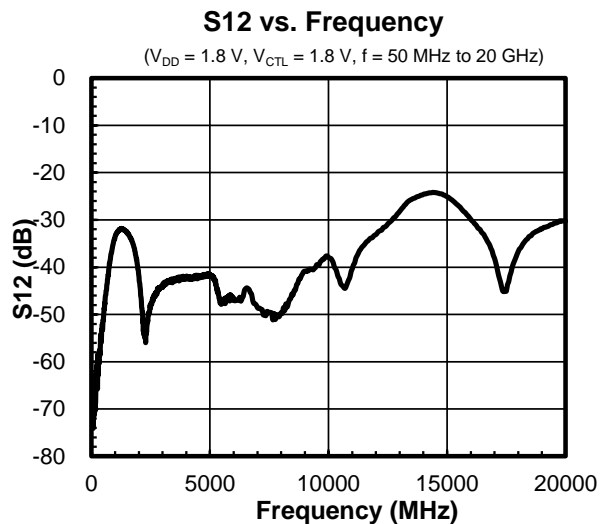
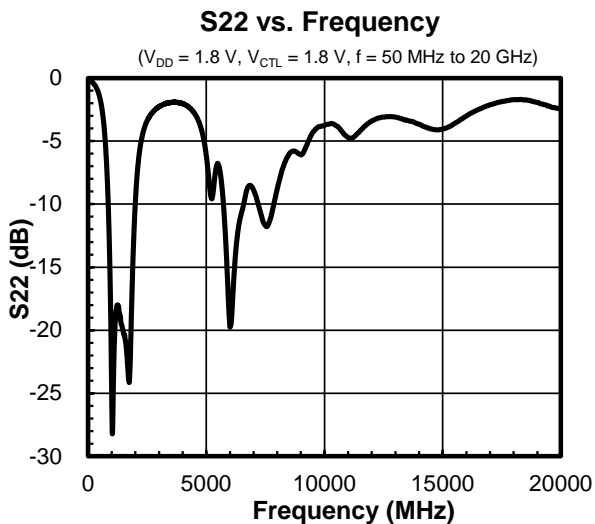
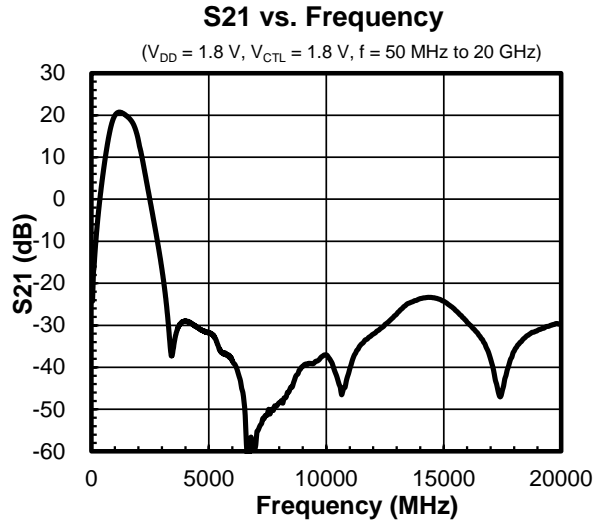
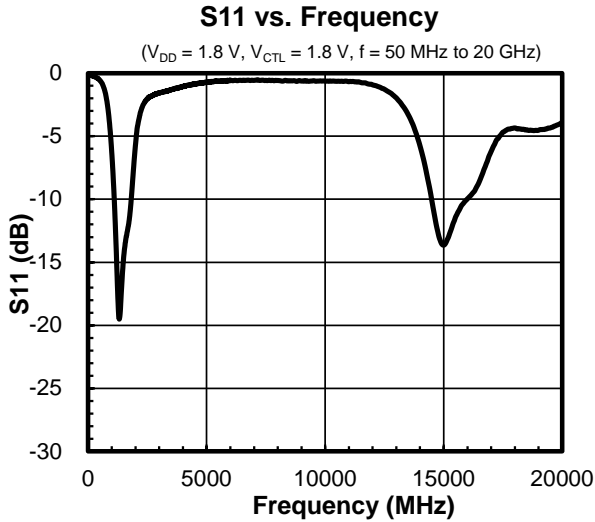

■ TYPICAL CHARACTERISTICS

General conditions:  $T_a = +25^\circ\text{C}$ ,  $Z_s = Z_l = 50\Omega$ , with application circuit  
 (Typical Characteristics are intended to be used as reference data; they are not guaranteed.)

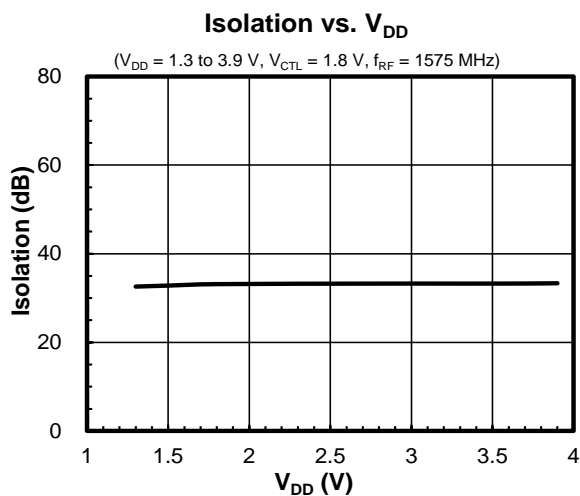
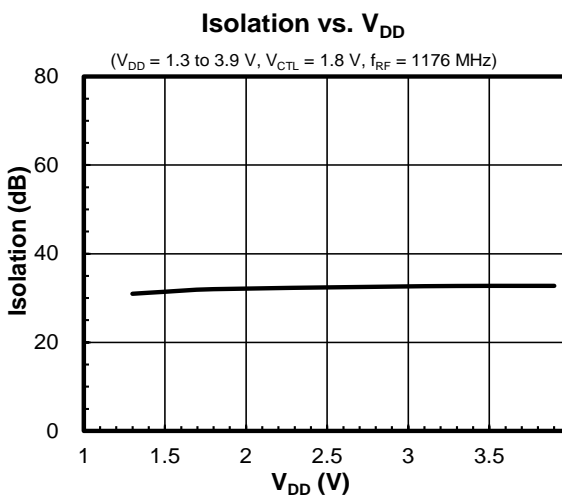
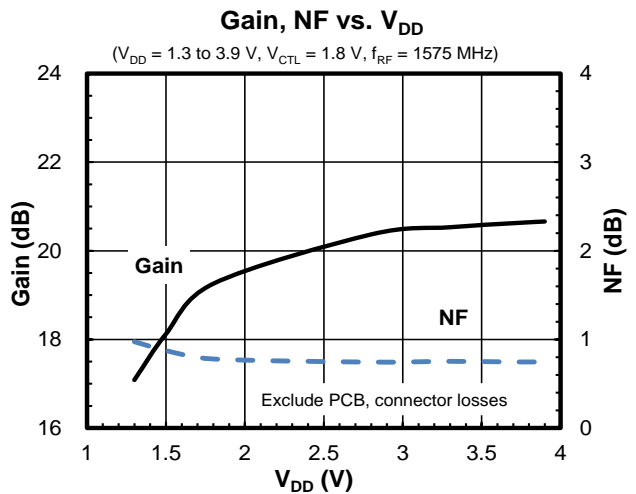
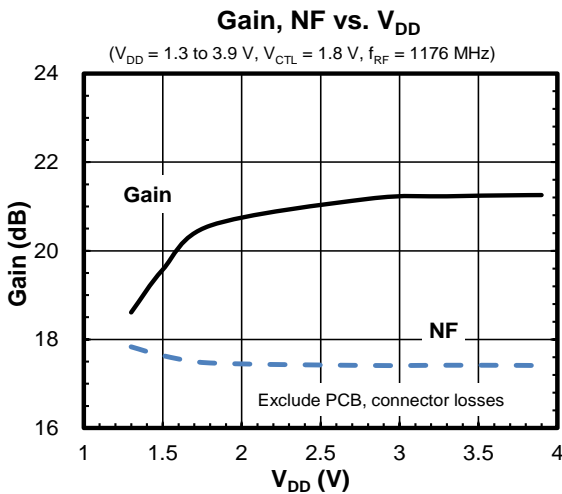
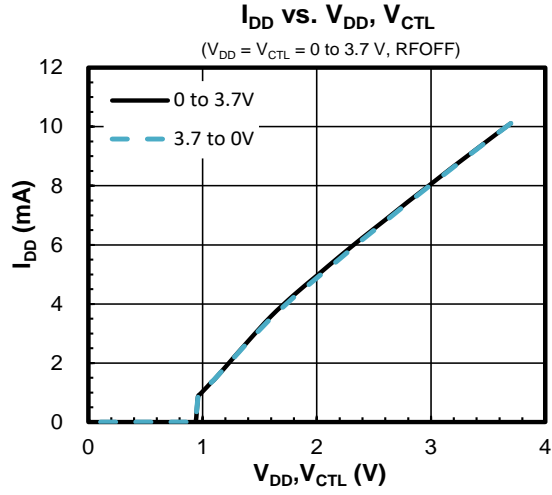
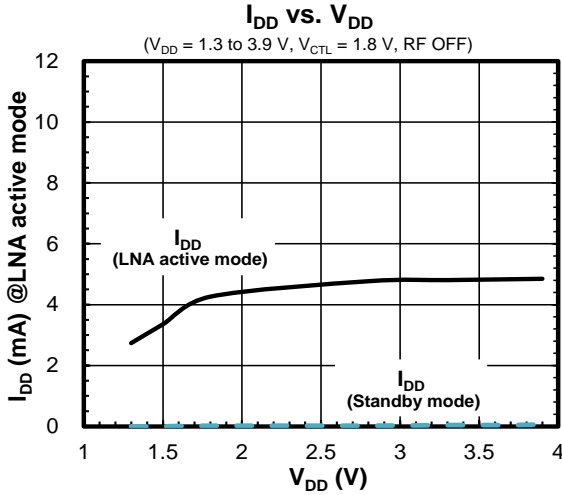

■ TYPICAL CHARACTERISTICS

General conditions:  $T_a = +25^\circ\text{C}$ ,  $Z_s = Z_l = 50\Omega$ , with application circuit  
 (Typical Characteristics are intended to be used as reference data; they are not guaranteed.)

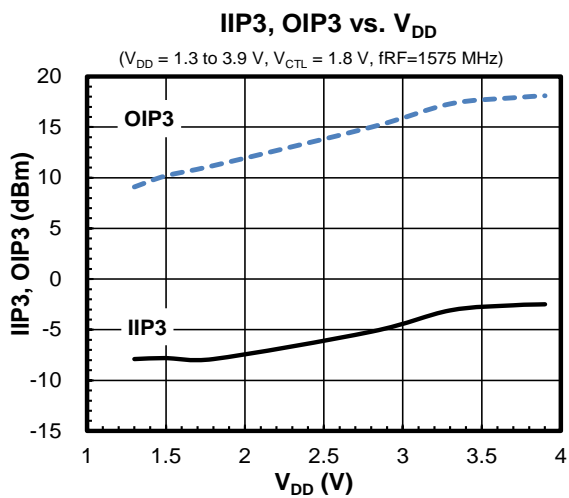
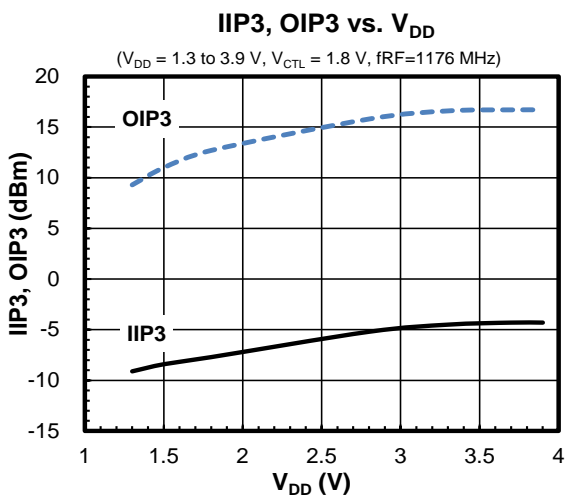
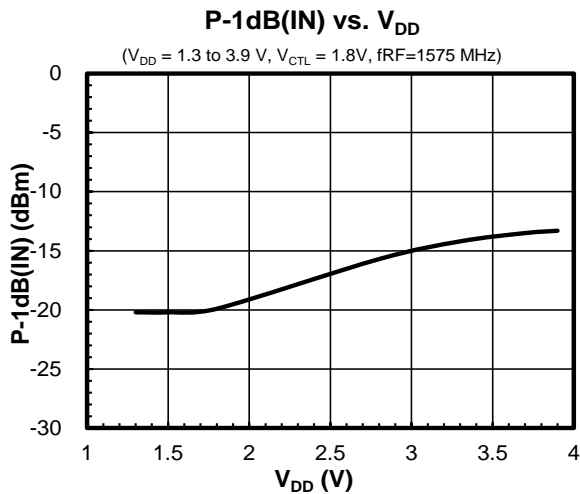
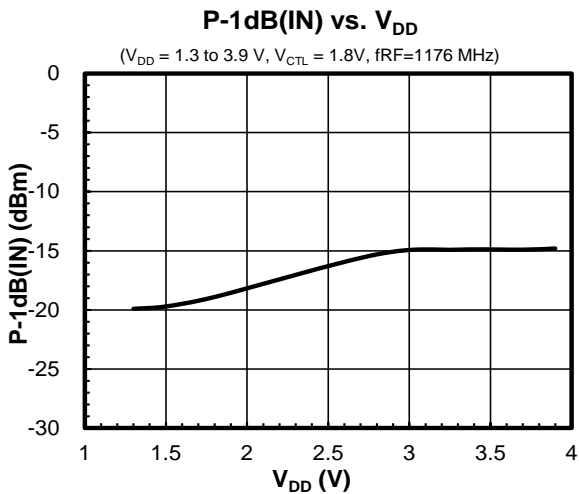
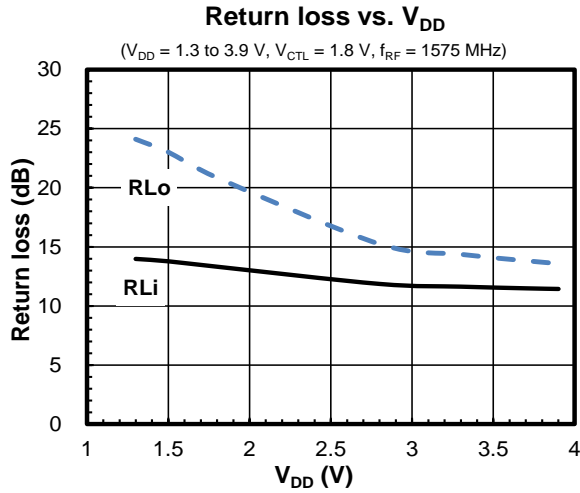
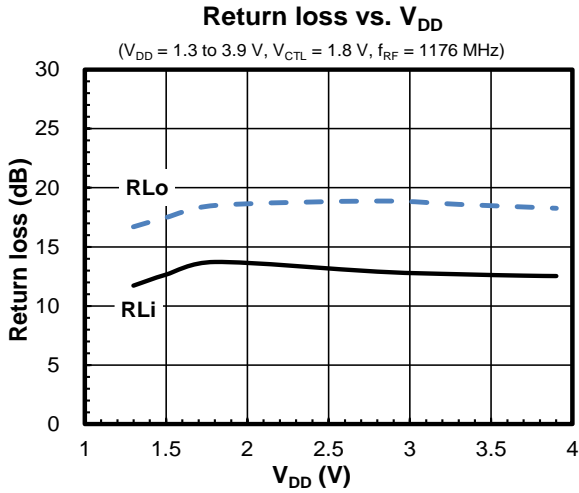

■ TYPICAL CHARACTERISTICS

General conditions:  $T_a = +25^\circ\text{C}$ ,  $Z_s = Z_l = 50\Omega$ , with application circuit  
 (Typical Characteristics are intended to be used as reference data; they are not guaranteed.)

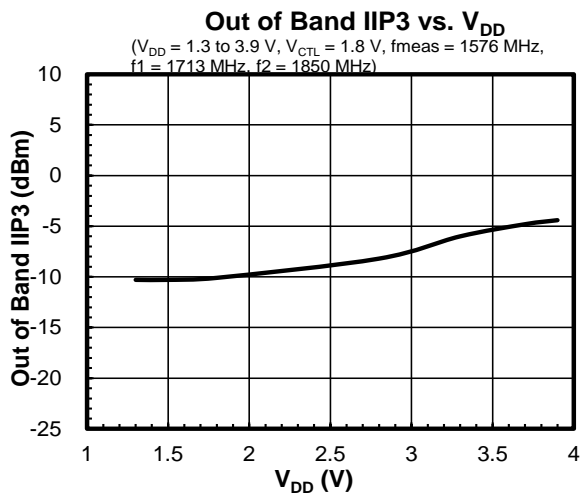
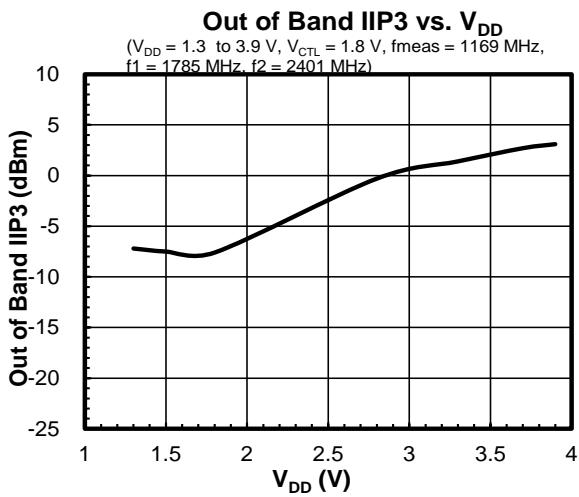
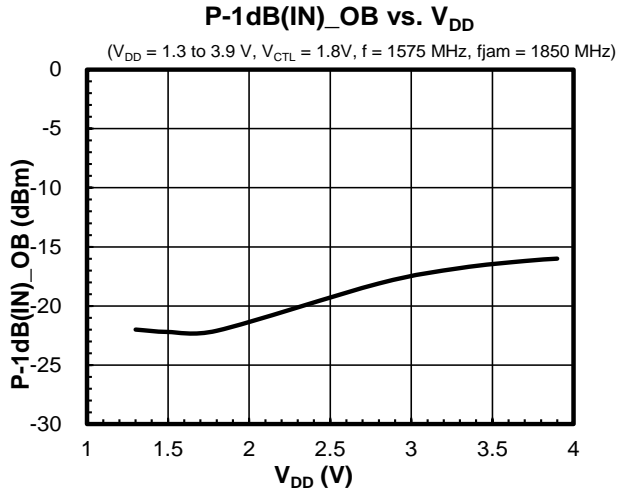
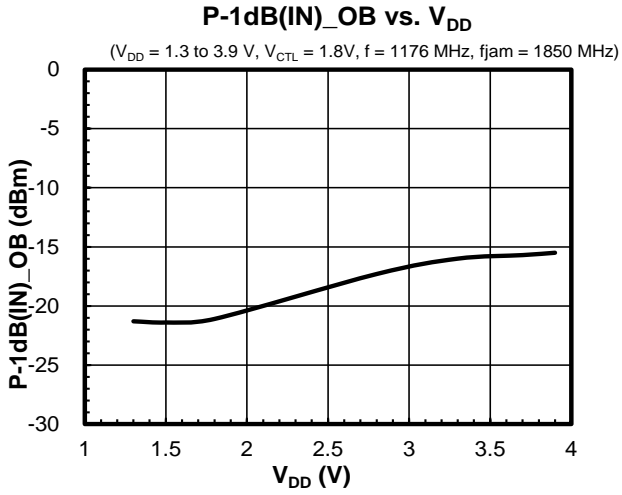

■ TYPICAL CHARACTERISTICS

General conditions:  $V_{DD} = 2.8\text{ V}$ ,  $V_{CTL} = 1.8\text{ V}$ ,  $Z_s = Z_l = 50\Omega$ , with application circuit  
 (Typical Characteristics are intended to be used as reference data; they are not guaranteed.)

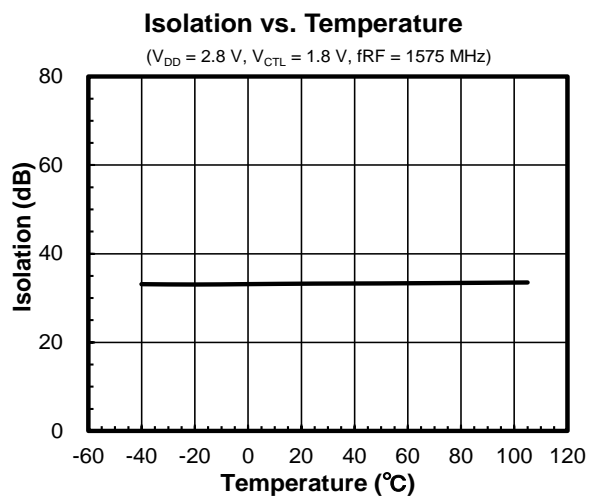
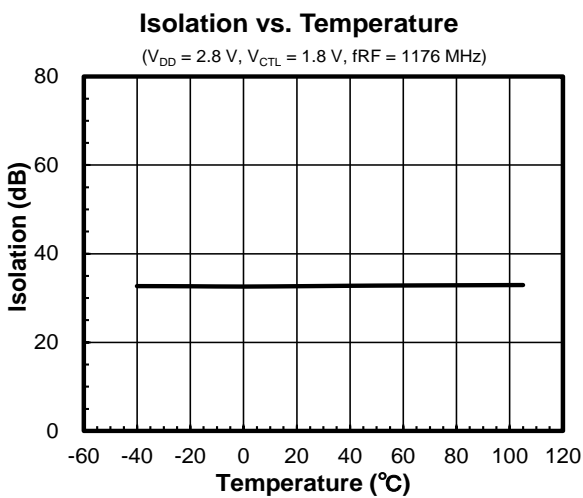
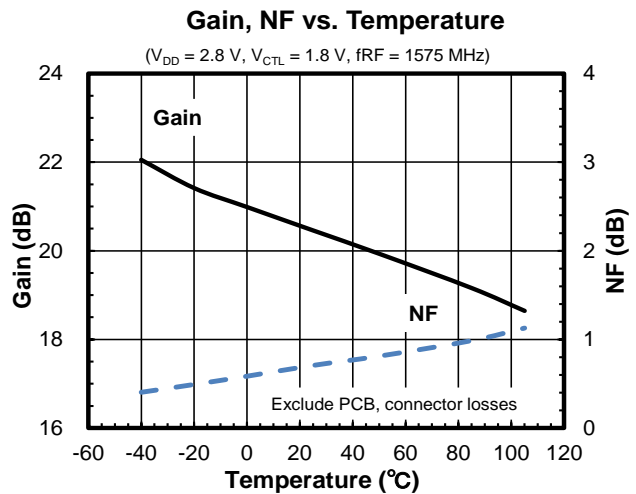
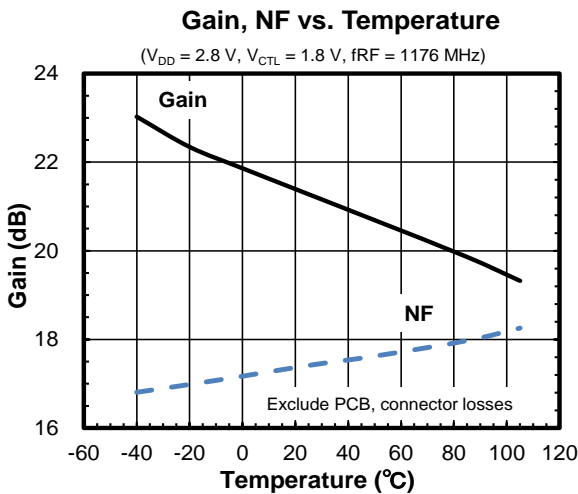
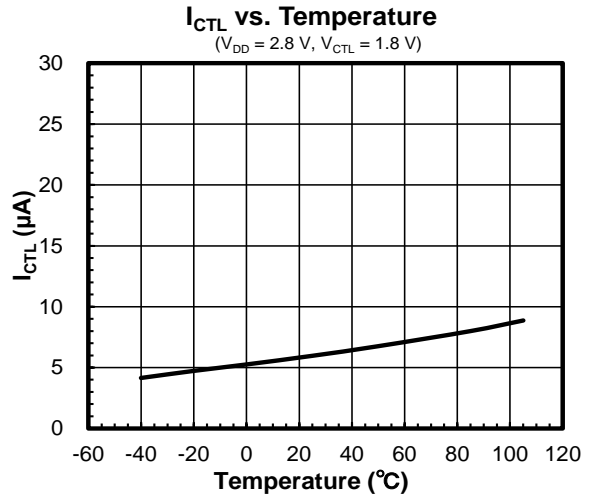
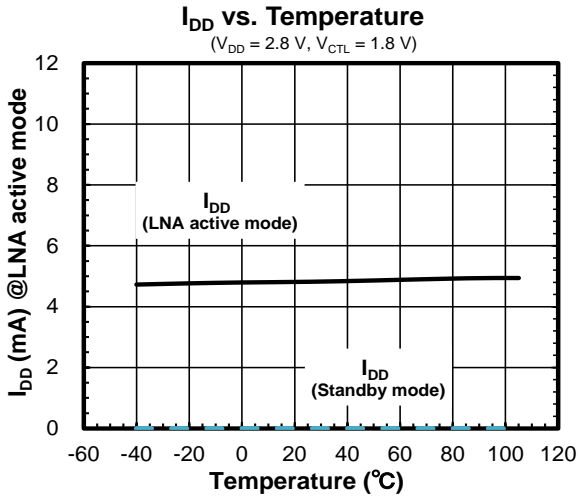

■ TYPICAL CHARACTERISTICS

General conditions:  $V_{DD} = 2.8\text{ V}$ ,  $V_{CTL} = 1.8\text{ V}$ ,  $Z_s = Z_l = 50\Omega$ , with application circuit  
 (Typical Characteristics are intended to be used as reference data; they are not guaranteed.)

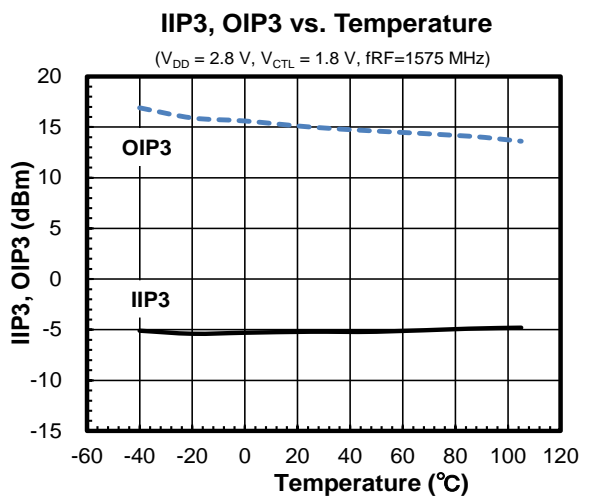
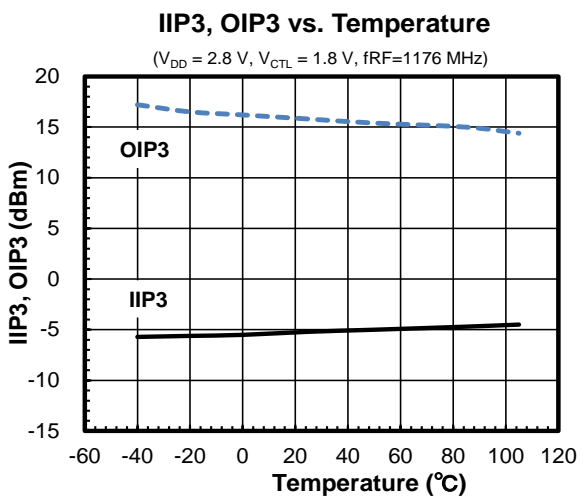
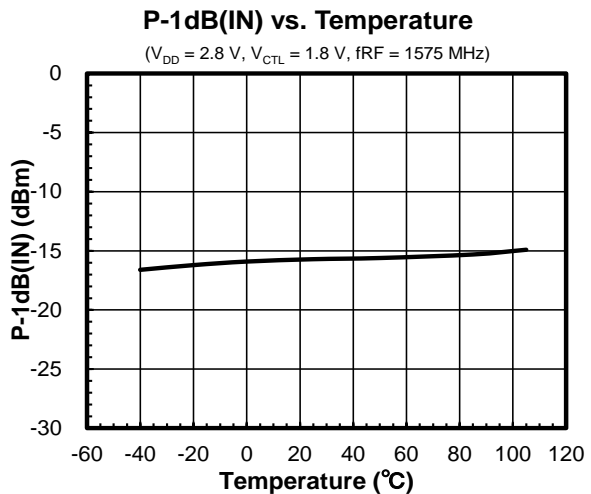
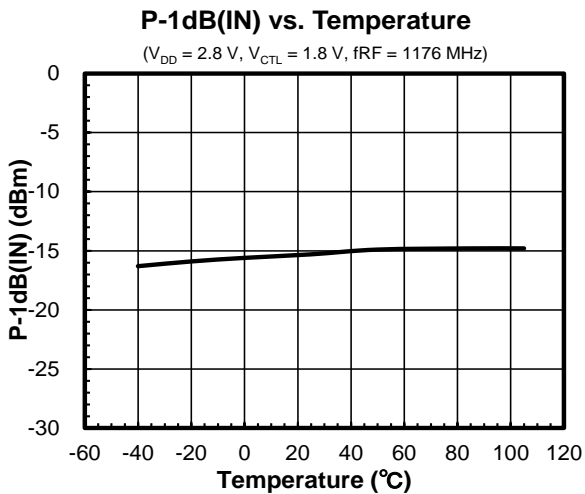
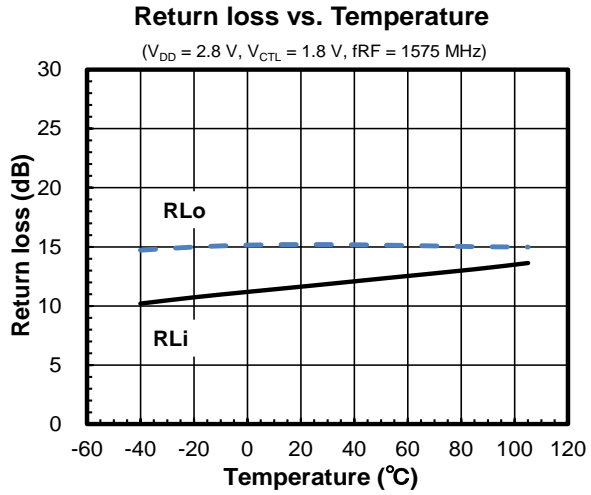
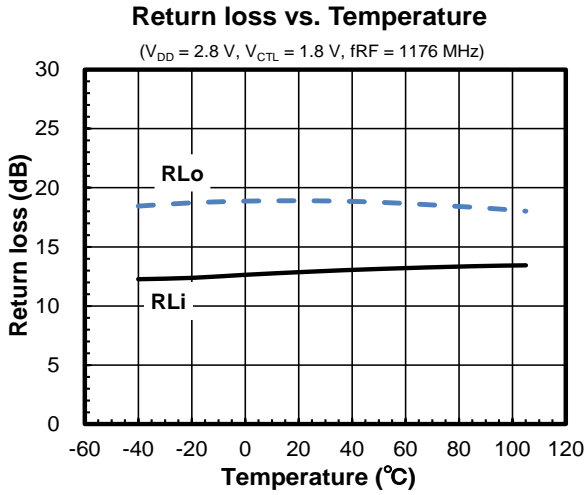

■ TYPICAL CHARACTERISTICS

General conditions:  $V_{DD} = 2.8\text{ V}$ ,  $V_{CTL} = 1.8\text{ V}$ ,  $Z_s = Z_l = 50\Omega$ , with application circuit  
 (Typical Characteristics are intended to be used as reference data; they are not guaranteed.)

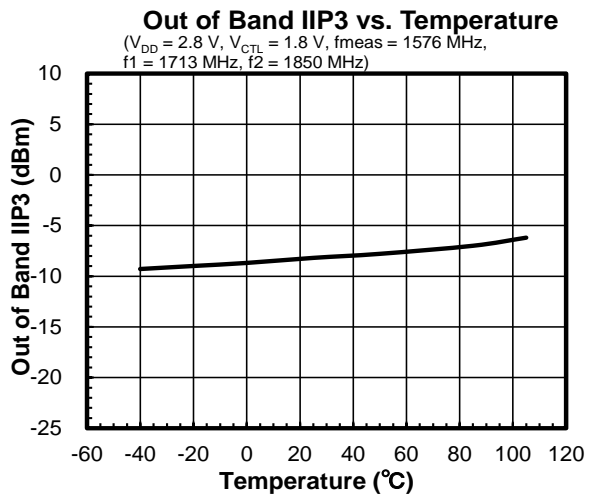
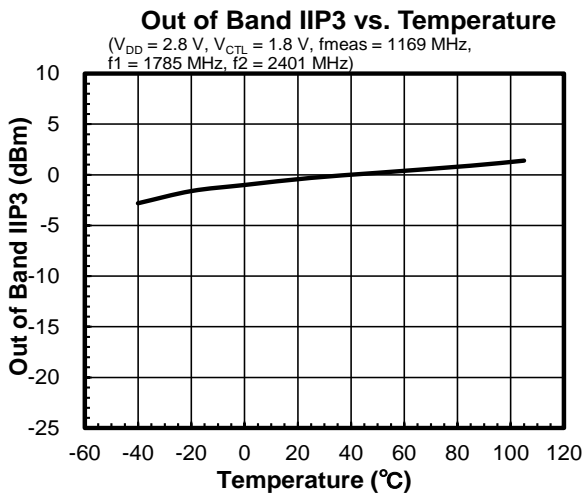
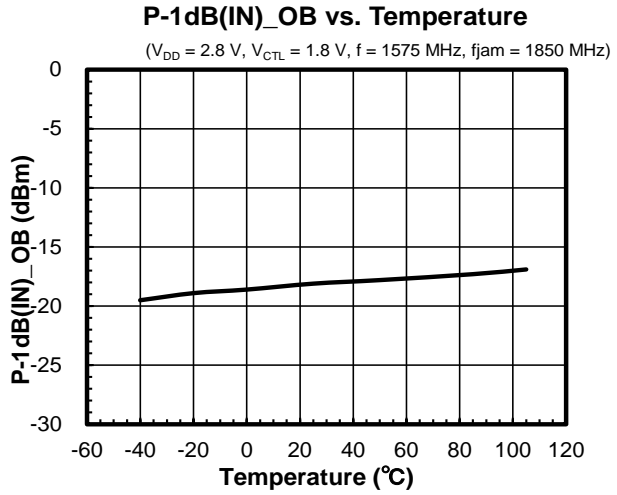
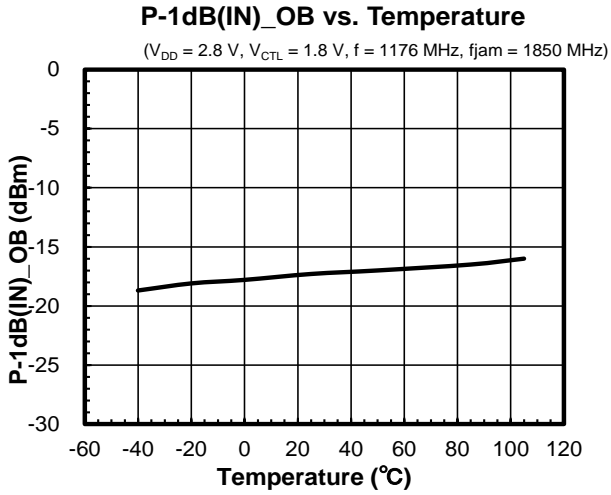

■ TYPICAL CHARACTERISTICS

General conditions:  $V_{DD} = 1.8\text{ V}$ ,  $V_{CTL} = 1.8\text{ V}$ ,  $Z_s = Z_l = 50\Omega$ , with application circuit  
 (Typical Characteristics are intended to be used as reference data; they are not guaranteed.)

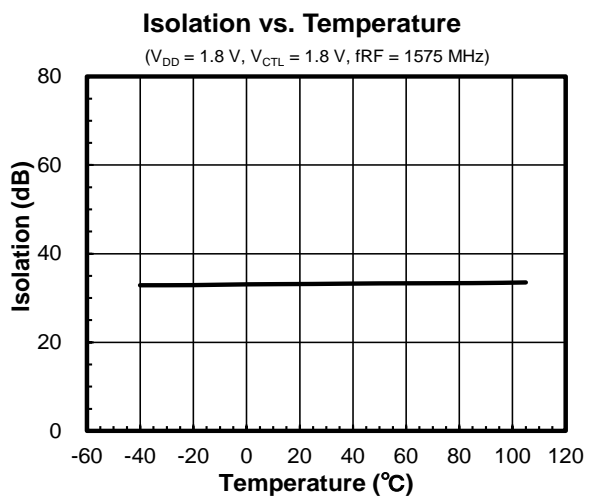
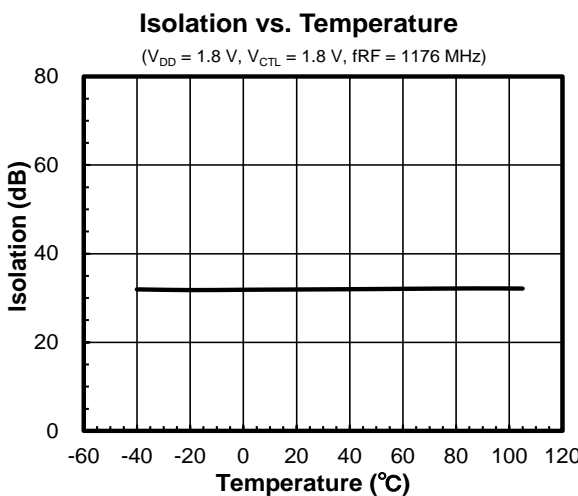
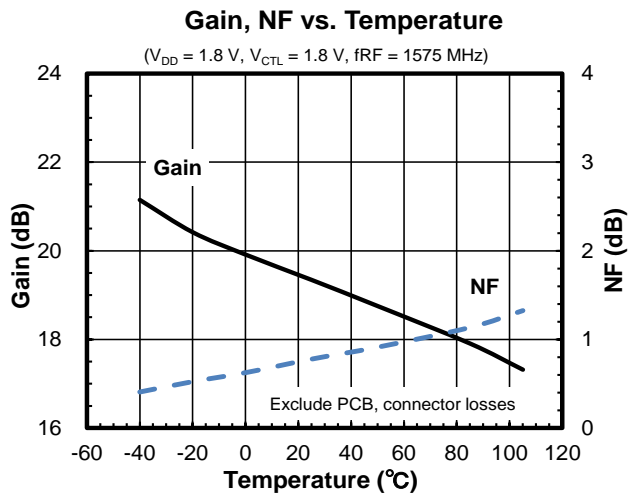
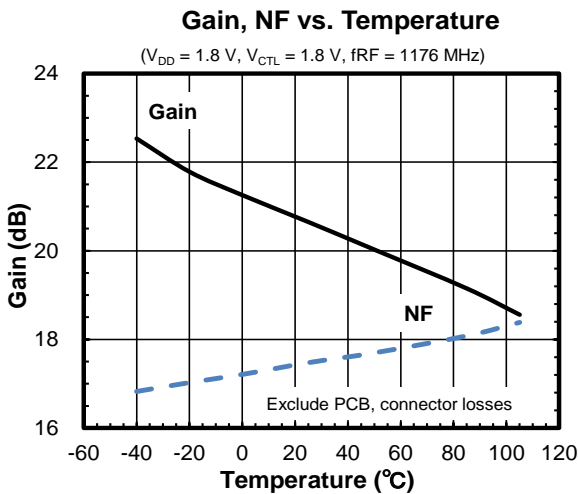
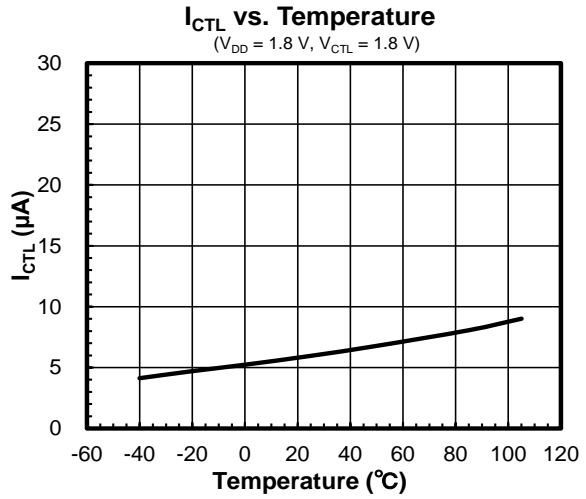
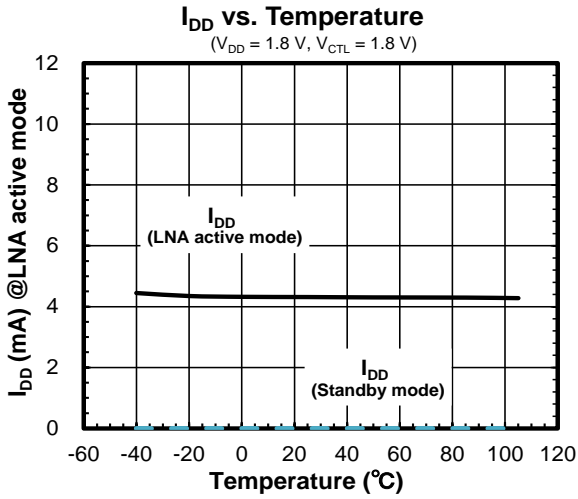



■ TYPICAL CHARACTERISTICS

General conditions:  $V_{DD} = 1.8\text{ V}$ ,  $V_{CTL} = 1.8\text{ V}$ ,  $Z_s = Z_l = 50\Omega$ , with application circuit  
 (Typical Characteristics are intended to be used as reference data; they are not guaranteed.)

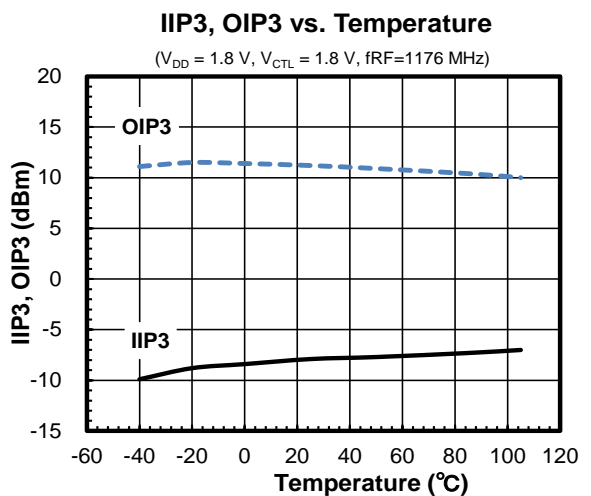
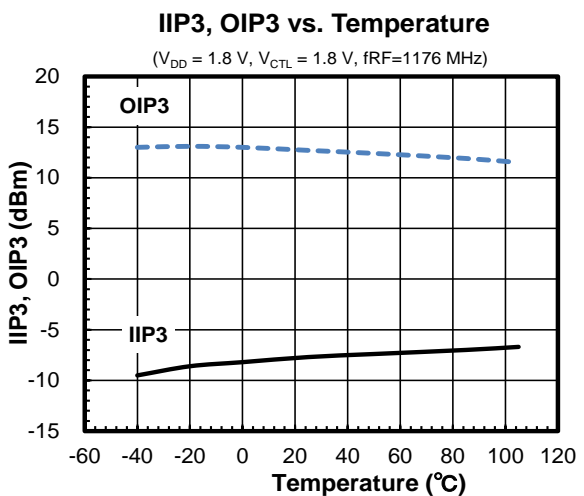
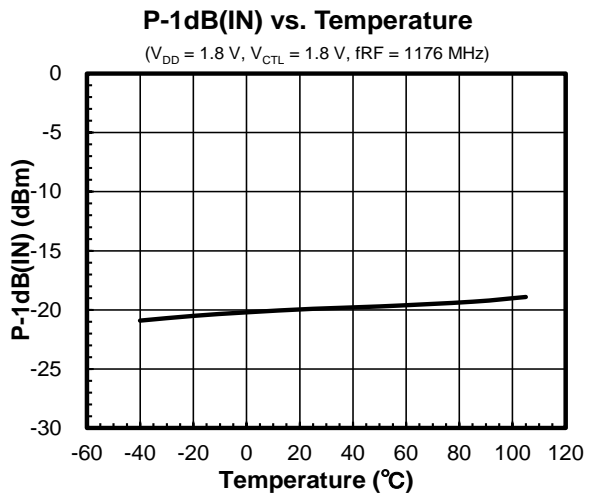
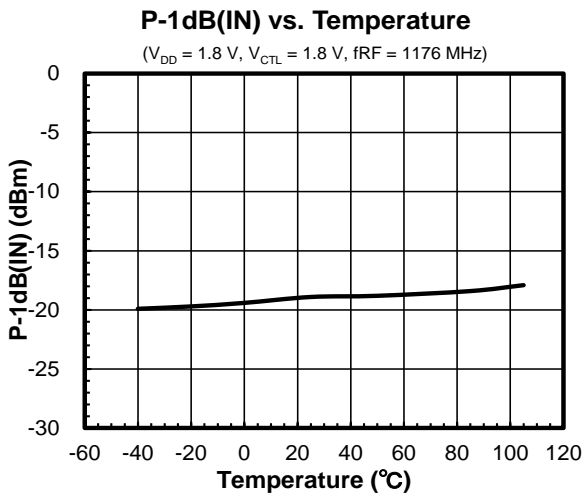
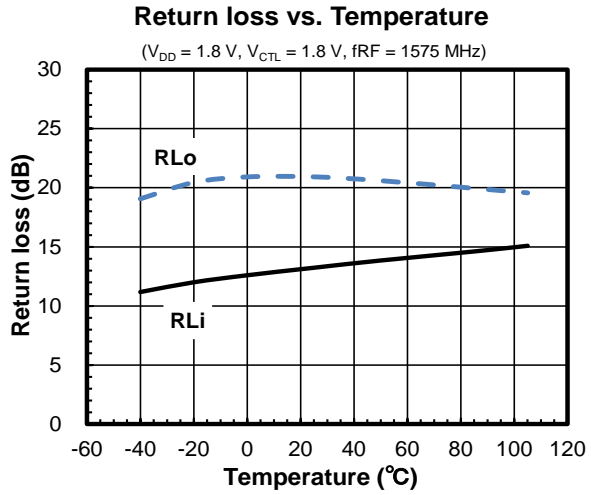
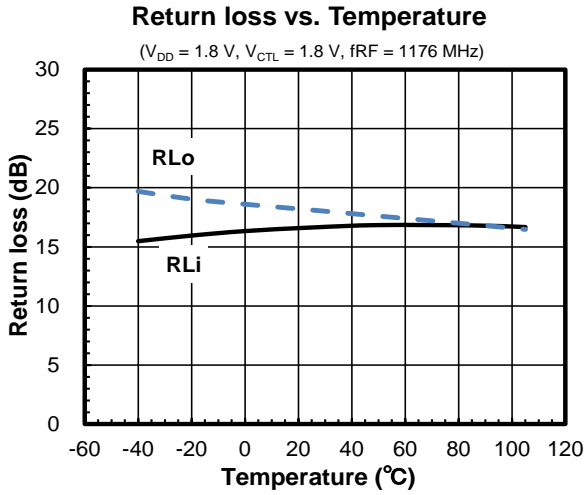

■ TYPICAL CHARACTERISTICS

General conditions:  $V_{DD} = 1.8\text{ V}$ ,  $V_{CTL} = 1.8\text{ V}$ ,  $Z_s = Z_l = 50\Omega$ , with application circuit  
 (Typical Characteristics are intended to be used as reference data; they are not guaranteed.)

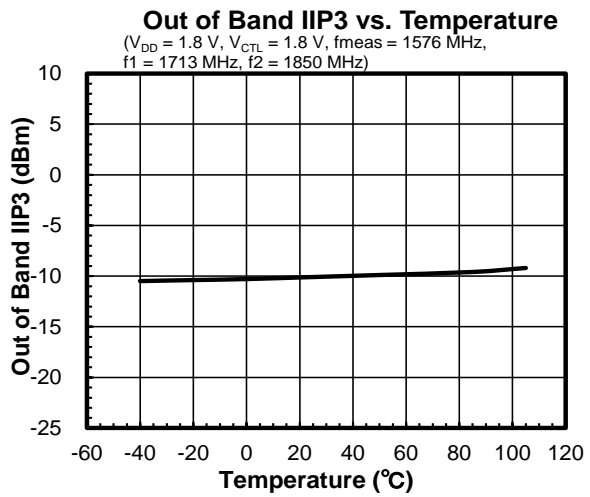
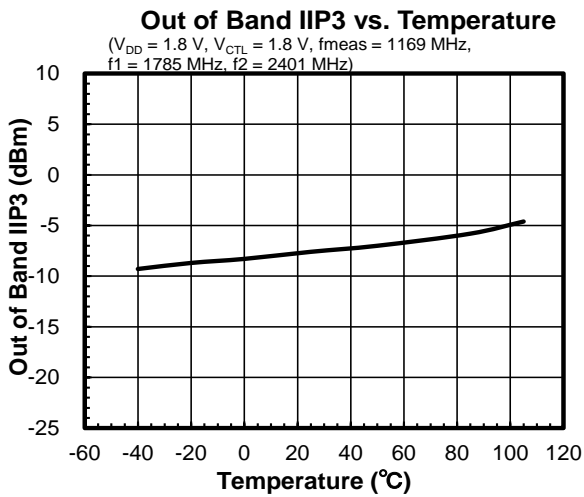
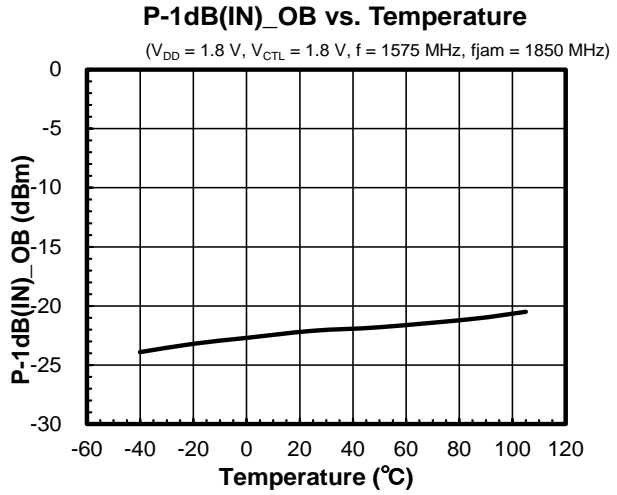
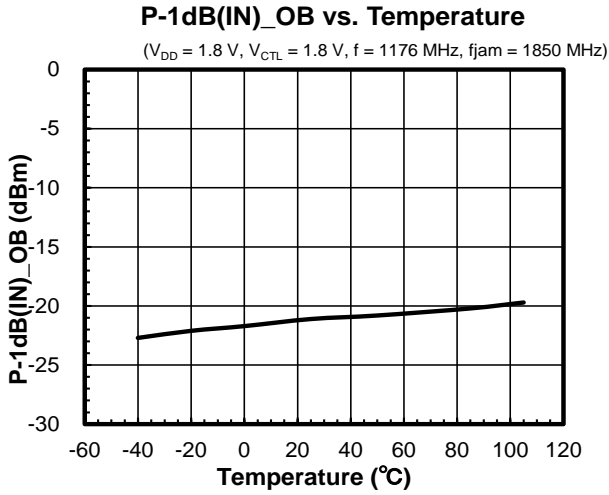

■ APPLICATION CIRCUIT

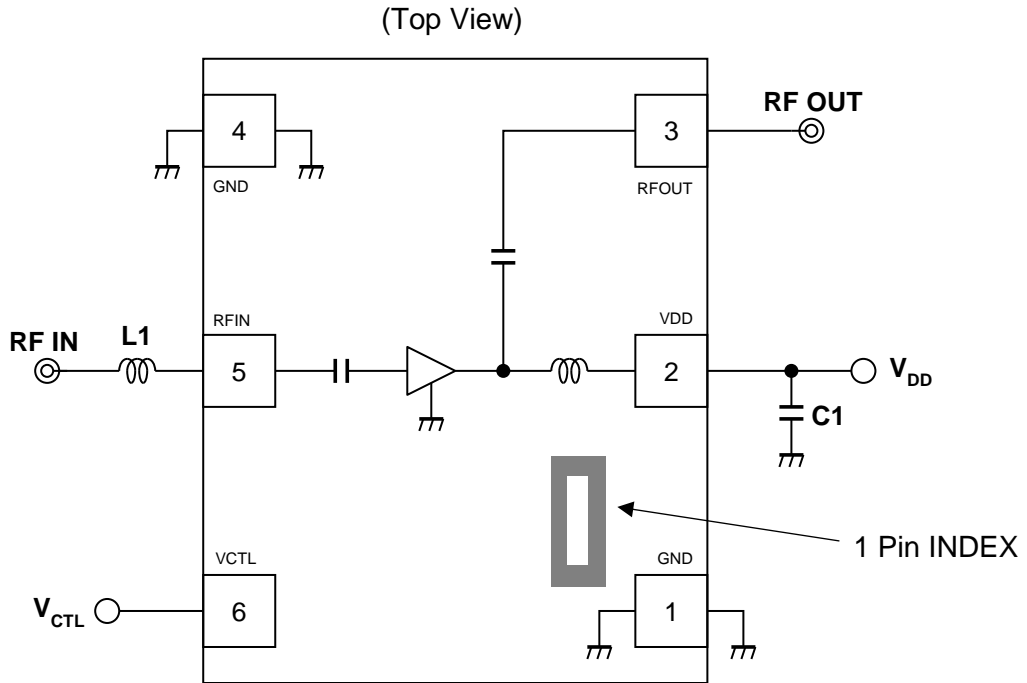

NT1193FAAE2S Typical Application Circuit

<Parts list>

Part ID	Value	Notes
L1	9.1 nH	LQW15AN series (MURATA)
C1	1000 pF	GRM03 series (MURATA)

● Evaluation Board / PCB layout

(Top View)

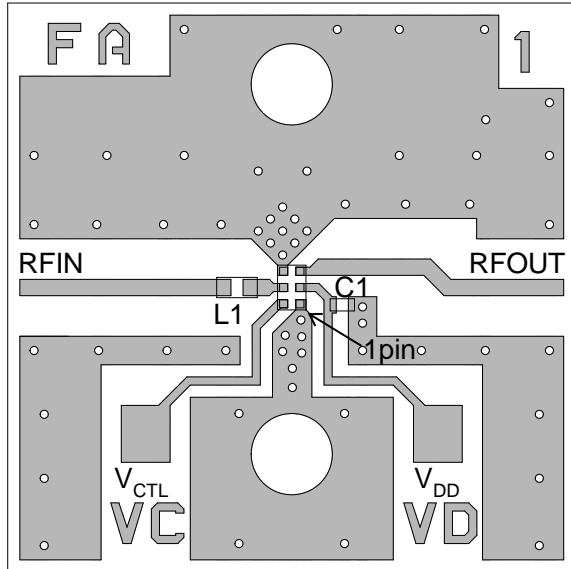

PCB

Substrate: FR-4  
 Thickness: 0.2 mm  
 Microstrip line width: 0.4 mm ( $Z_0=50\Omega$ )  
 Size: 14.0 x 14.0 mm

● PCB layout guideline

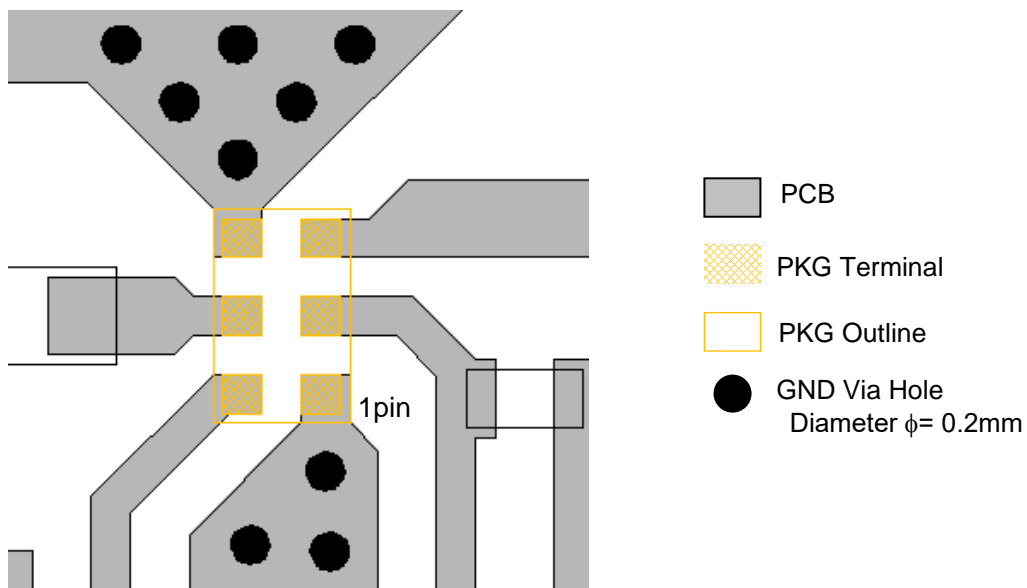

● PRECAUTIONS

- All external parts should be placed as close as possible to the LNA.
- For good RF performance, all GND terminals must be connected to PCB ground plane of substrate, and via-holes for GND should be placed near the LNA.

**MARKING SPECIFICATION**

- ① : Product Code
- ② : Lot Number ... Alphanumeric Serial Number

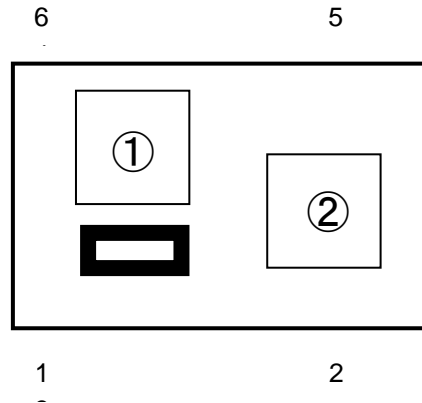

**EPFFP-6-FA Marking Specification**

**NOTICE**

There can be variation in the marking when different AOI (Automated Optical Inspection) equipment is used. In the case of recognizing the marking characteristic with AOI, please contact our sales or distributor before attempting to use AOI.

**EPFFP-6-FA Marking List**

<b>Product Name</b>	①
NT1193FAAE2S	9

■ APPLICATION NOTES

● NF Measurement Block Diagram

**Measuring Instruments**

Signal Analyzer : Keysight N9010B  
 Noise Source : Keysight N4000A

**Setting the Signal analyzer**

Mode/Measurement/View Selector  
 Mode : Noise Figure  
 Measurement : Noise Figure  
 Frequency  
 Center Frequency : 1.4 GHz  
 Span : 600 MHz  
 Points : 61  
 Amplitude  
 Attenuation : 0 dB  
 Signal Path : Internal Preamp on (Auto)  
 BW  
 Res BW : 4 MHz (Auto)  
 Meas Setup  
 Averaging : On  
 Avg/Hold Num : 16  
 Tcold : SNS Tcold On

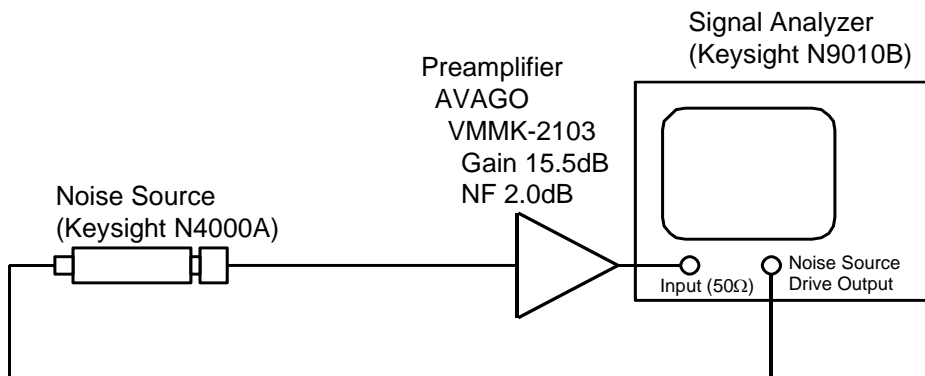

\*Preamplifier is used to improve NF measurement accuracy.  
 \* Noise source, preamplifier and NF analyzer are connected directly.

**Calibration Setup**

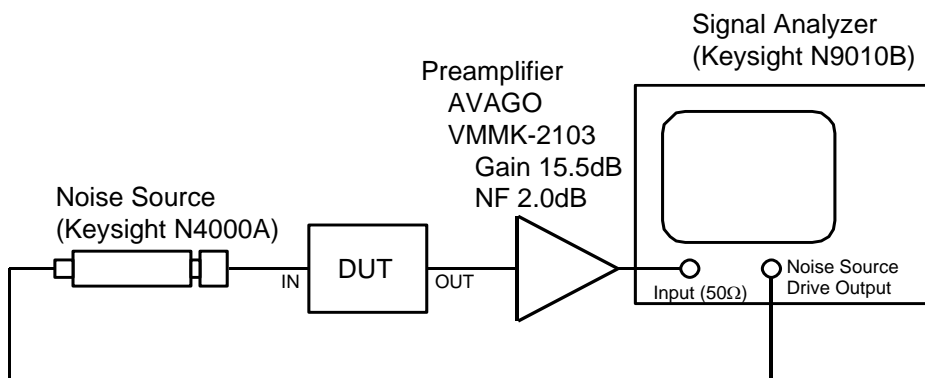

\* Noise source, DUT, preamplifier and NF analyzer are connected directly.

**Measurement Setup**

## ■ REVISION HISTORY

Date	Revision	Contents of Changes
March 13, 2024	Ver. 1.0	Initial release

■ PACKAGE DIMENSIONS

UNIT: mm

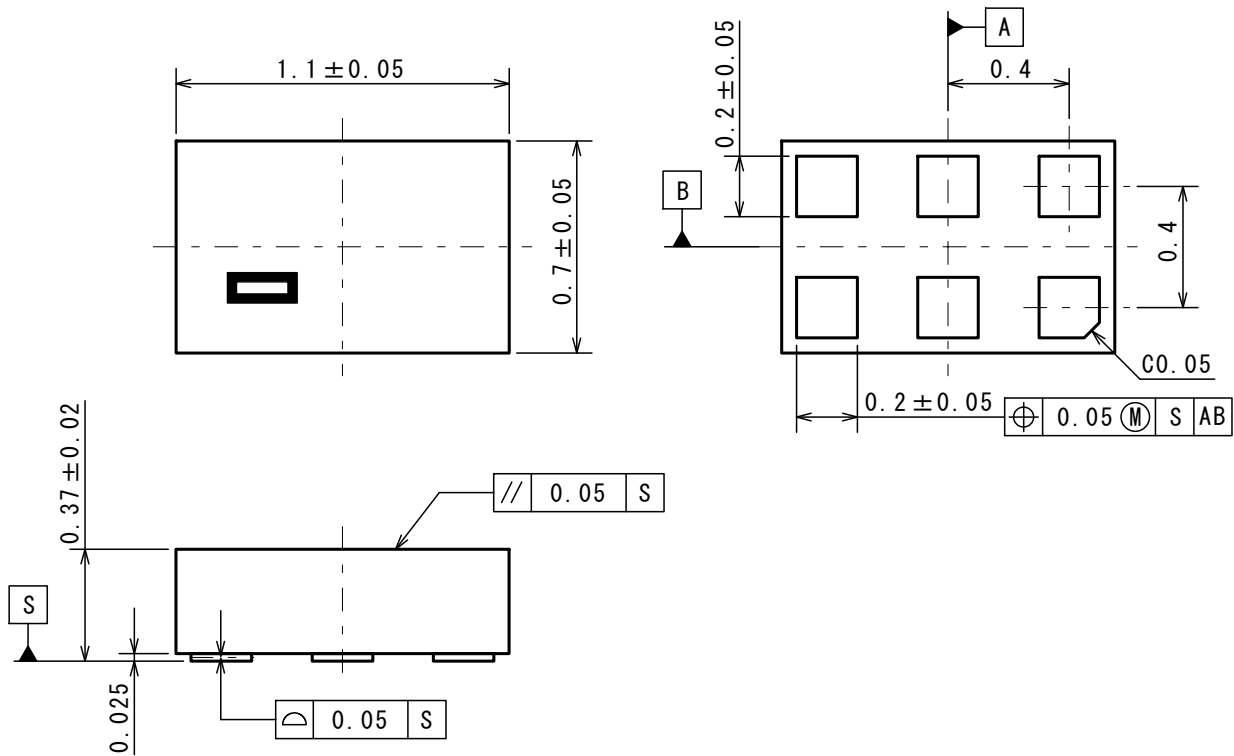

■ EXAMPLE OF SOLDER PADS DIMENSIONS

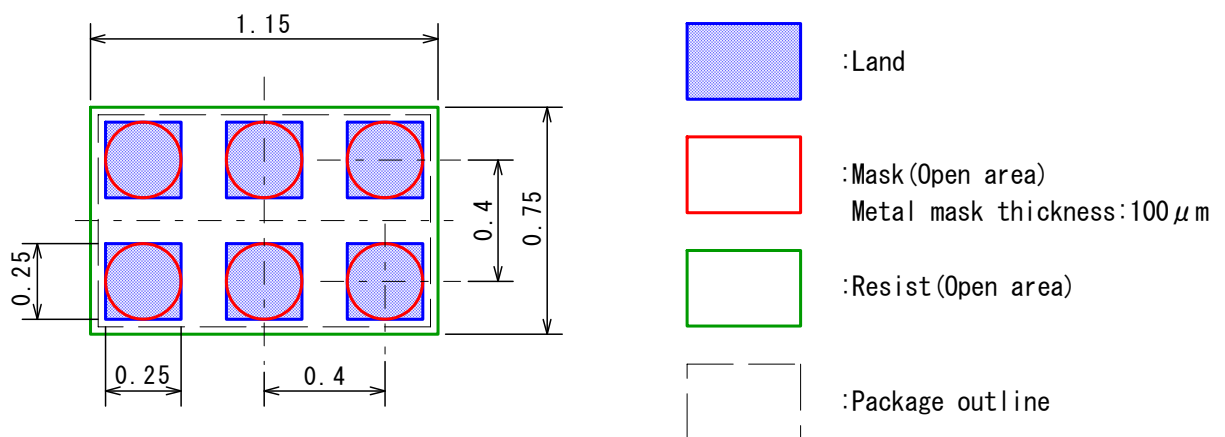



# Nisshinbo Micro Devices Inc.

EPFFP-6-FA

PI-EPFFP-6-FA-E-A

■ PACKING SPEC

UNIT: mm

(1) Taping dimensions / Insert direction

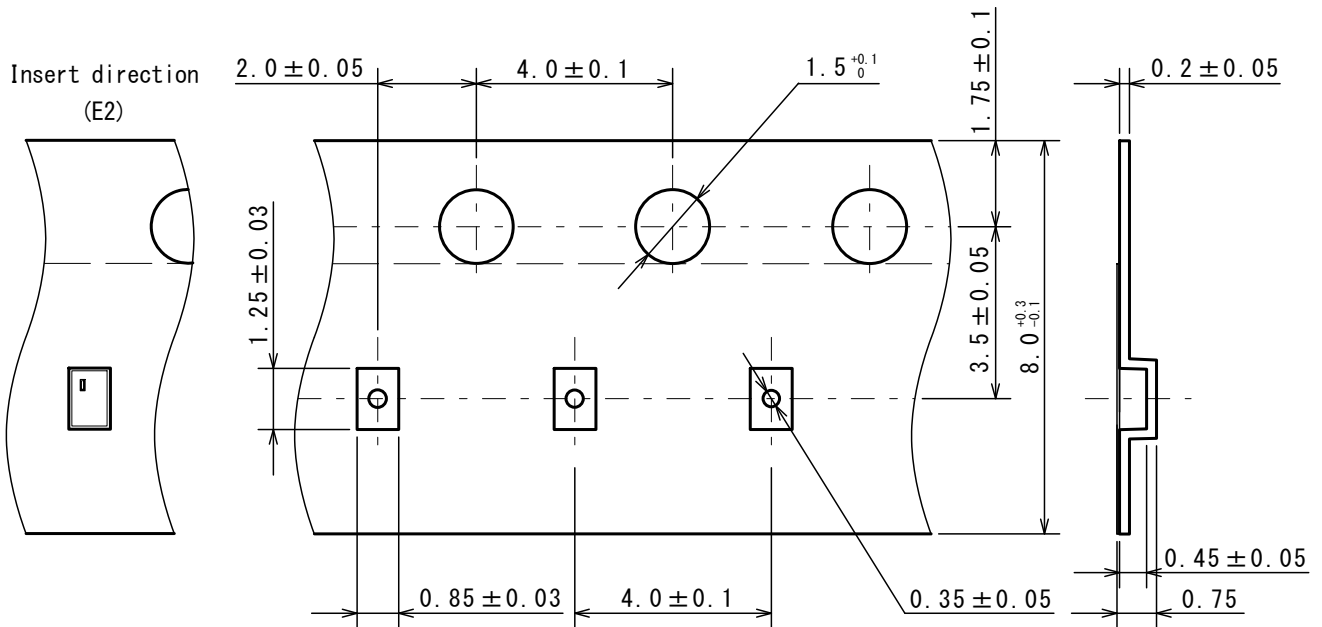

(2) Taping state

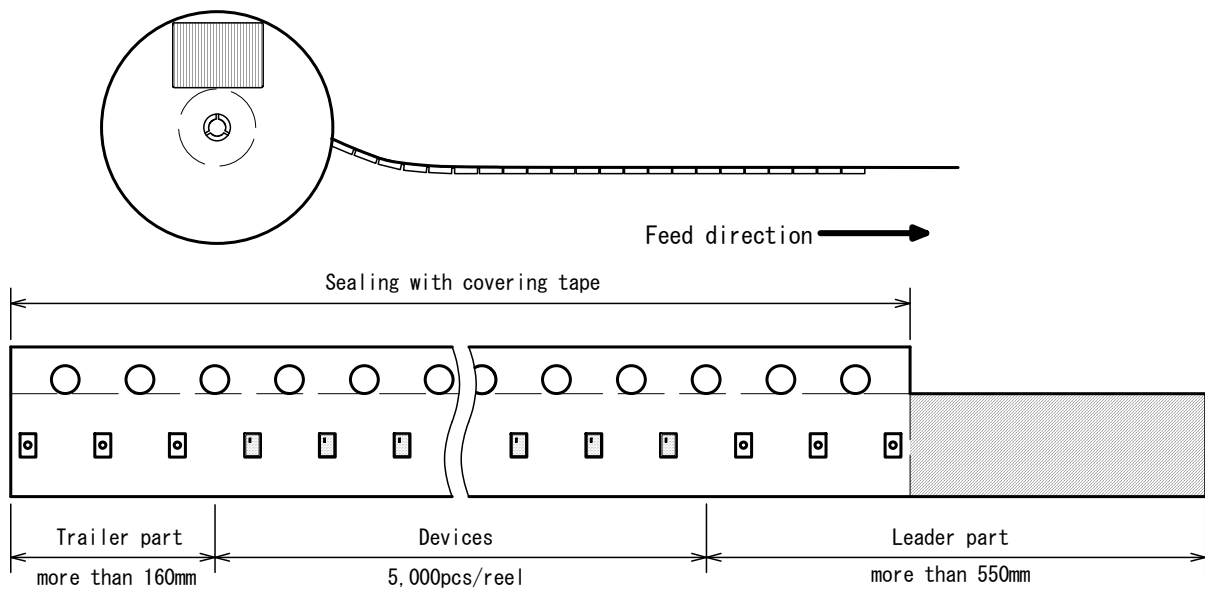

(3) Reel dimensions

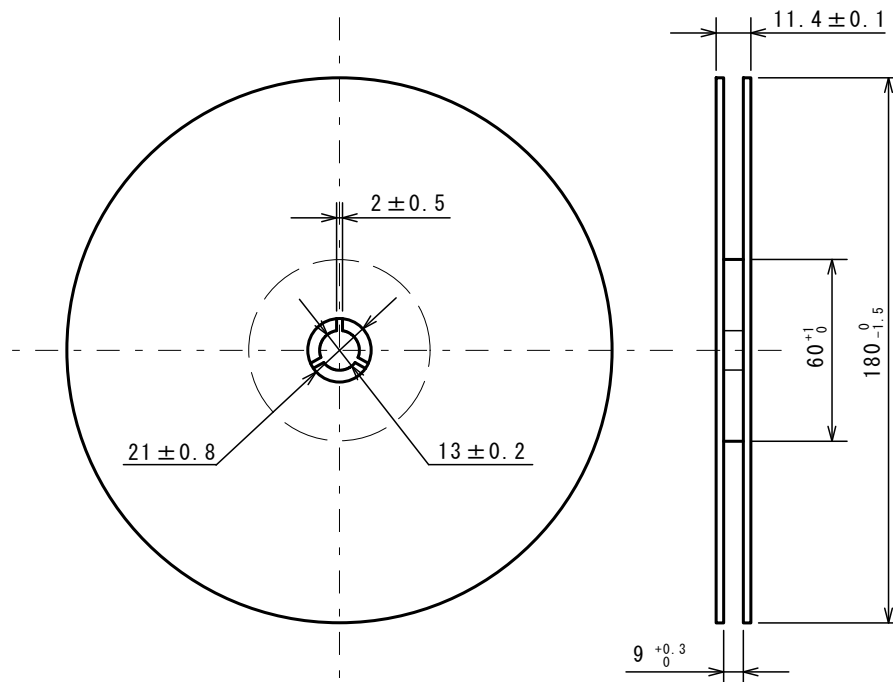

(4) Peeling strength

Peeling strength of cover tape

- Peeling angle 165 to 180° degrees to the taped surface.
- Peeling speed 300mm/min
- Peeling strength 0.1 to 1.0N

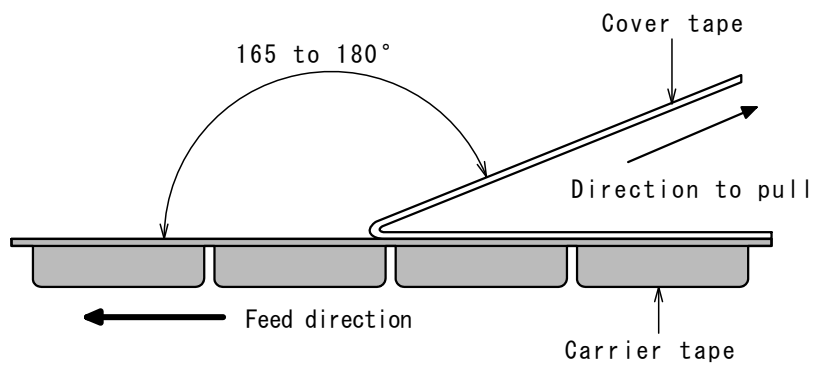

(5) Packing state

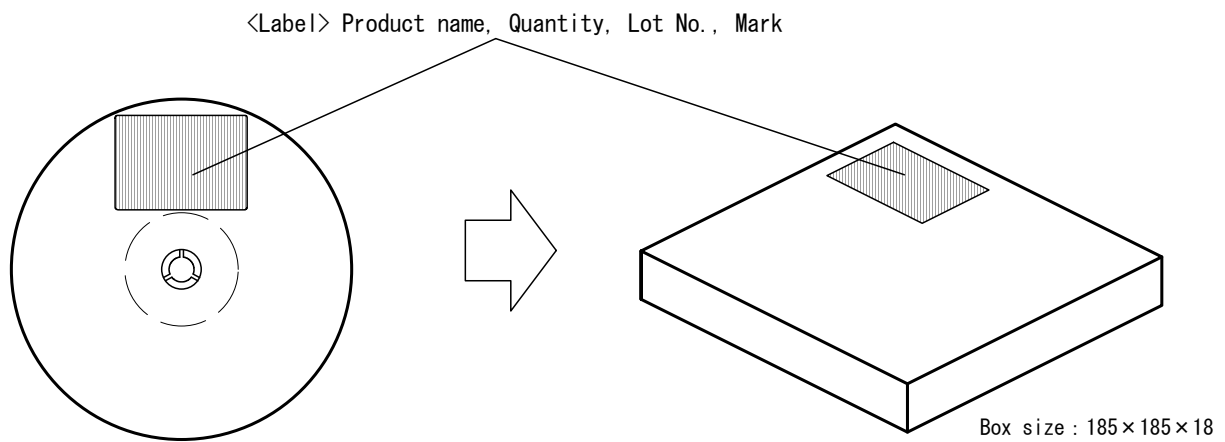

■ HEAT-RESISTANCE PROFILES

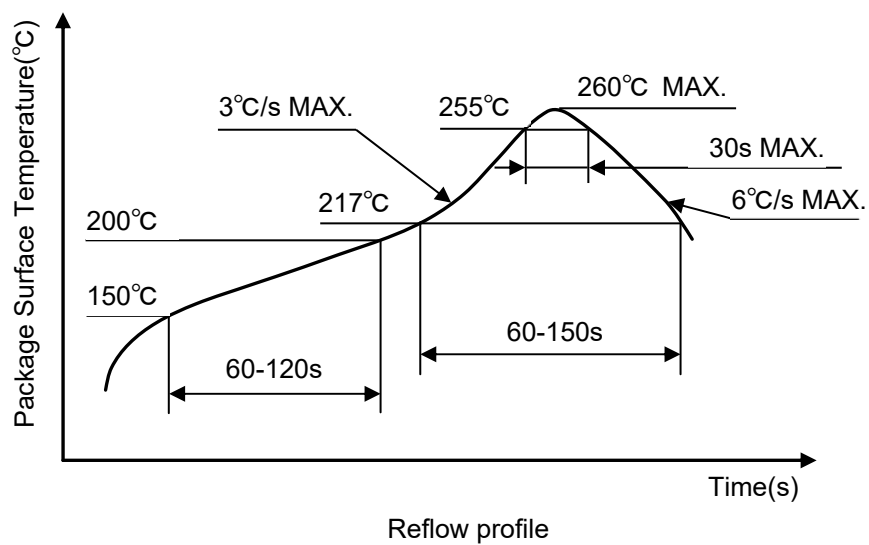

1. The products and the product specifications described in this document are subject to change or discontinuation of production without notice for reasons such as improvement. Therefore, before deciding to use the products, please refer to our sales representatives for the latest information thereon.
2. The materials in this document may not be copied or otherwise reproduced in whole or in part without the prior written consent of us.
3. This product and any technical information relating thereto are subject to complementary export controls (so-called KNOW controls) under the Foreign Exchange and Foreign Trade Law, and related politics ministerial ordinance of the law. (Note that the complementary export controls are inapplicable to any application-specific products, except rockets and pilotless aircraft, that are insusceptible to design or program changes.) Accordingly, when exporting or carrying abroad this product, follow the Foreign Exchange and Foreign Trade Control Law and its related regulations with respect to the complementary export controls.
4. The technical information described in this document shows typical characteristics and example application circuits for the products. The release of such information is not to be construed as a warranty of or a grant of license under our or any third party's intellectual property rights or any other rights.
5. The products listed in this document are intended and designed for use as general electronic components in standard applications (office equipment, telecommunication equipment, measuring instruments, consumer electronic products, amusement equipment etc.). Those customers intending to use a product in an application requiring extreme quality and reliability, for example, in a highly specific application where the failure or misoperation of the product could result in human injury or death should first contact us.
  - Aerospace Equipment
  - Equipment Used in the Deep Sea
  - Power Generator Control Equipment (nuclear, steam, hydraulic, etc.)
  - Life Maintenance Medical Equipment
  - Fire Alarms / Intruder Detectors
  - Vehicle Control Equipment (automotive, airplane, railroad, ship, etc.)
  - Various Safety Devices
  - Traffic control system
  - Combustion equipment

In case your company desires to use this product for any applications other than general electronic equipment mentioned above, make sure to contact our company in advance. Note that the important requirements mentioned in this section are not applicable to cases where operation requirements such as application conditions are confirmed by our company in writing after consultation with your company.

6. We are making our continuous effort to improve the quality and reliability of our products, but electronic device products are likely to fail with certain probability. In order to prevent any injury to persons or damages to property resulting from such failure, customers should be careful enough to incorporate safety measures in their design, such as redundancy feature, fire containment feature and fail-safe feature. We do not assume any liability or responsibility for any loss or damage arising from misuse or inappropriate use of the products.
7. The products have been designed and tested to function within controlled environmental conditions. Do not use products under conditions that deviate from methods or applications specified in this datasheet. Failure to employ the products in the proper applications can lead to deterioration, destruction or failure of the products. We shall not be responsible for any bodily injury, fires or accident, property damage or any consequential damages resulting from misuse or misapplication of the products.
8. **Quality Warranty**
  - 8-1. **Quality Warranty Period**

In the case of a product purchased through an authorized distributor or directly from us, the warranty period for this product shall be one (1) year after delivery to your company. For defective products that occurred during this period, we will take the quality warranty measures described in section 8-2. However, if there is an agreement on the warranty period in the basic transaction agreement, quality assurance agreement, delivery specifications, etc., it shall be followed.
  - 8-2. **Quality Warranty Remedies**

When it has been proved defective due to manufacturing factors as a result of defect analysis by us, we will either deliver a substitute for the defective product or refund the purchase price of the defective product.

Note that such delivery or refund is sole and exclusive remedies to your company for the defective product.
  - 8-3. **Remedies after Quality Warranty Period**

With respect to any defect of this product found after the quality warranty period, the defect will be analyzed by us. On the basis of the defect analysis results, the scope and amounts of damage shall be determined by mutual agreement of both parties. Then we will deal with upper limit in Section 8-2. This provision is not intended to limit any legal rights of your company.
9. Anti-radiation design is not implemented in the products described in this document.
10. The X-ray exposure can influence functions and characteristics of the products. Confirm the product functions and characteristics in the evaluation stage.
11. Warning for handling Gallium and Arsenic (GaAs) products (Applying to GaAs MMIC, Photo Reflector). These products use Gallium (Ga) and Arsenic (As) which are specified as poisonous chemicals by law. For the prevention of a hazard, do not burn, destroy, or process chemically to make them as gas or power. When the product is disposed of, please follow the related regulation and do not mix this with general industrial waste or household waste.
12. Front end module product is hollow seal package type, and it is with the structure susceptible to stress from the outside. Therefore, note the following in relation to the contents, after conducting an evaluation. please use.
  - 12-1. After mounting this product, to implement the potting and transfer molding, please the confirmation of resistance to temperature changes and shrinkage stress involved in the molding.
  - 12-2. When mounted on the product, collet diameter please use more than 1mmφ. In addition, the value of static load is recommended mounting less than 5N.
  - 12-3. For dynamic load at the time of mounting. please use it after confirming in consideration of the contact area /speed /load.
13. Please contact our sales representatives should you have any questions or comments concerning the products or the technical information.



**Nisshinbo Micro Devices Inc.**

**Official website**

<https://www.nisshinbo-microdevices.co.jp/en/>

**Purchase information**

<https://www.nisshinbo-microdevices.co.jp/en/buy/>