

bq25606 Standalone 3.0-A Single Cell Battery Charger

1 Features

- High-Efficiency, 1.5-MHz, Synchronous Switch-Mode Buck Charger
 - 92% Charge Efficiency at 2 A from 5-V Input
 - Optimized for USB Voltage Input (5 V)
- Supports USB On-The-Go (OTG)
 - Boost Converter With Up to 1.2-A Output
 - 92% Boost Efficiency at 1-A Output
 - Accurate Constant Current (CC) Limit
 - Soft-Start Up To 500- μ F Capacitive Load
 - Output Short Circuit Protection
- Single Input to Support USB Input and High Voltage Adapters
 - Support 3.9-V to 13.5-V Input Voltage Range With 22-V Absolute Maximum Input Voltage Rating
 - Maximum Power Tracking by Input Voltage Limit Up to 4.6 V (VINDPM)
 - VINDPM Threshold Automatically Tracks Battery Voltage
 - Auto Detect USB SDP, DCP and Non-Standard Adaptors
- High Battery Discharge Efficiency With 19.5-m Ω Battery Discharge MOSFET
- Narrow VDC (NVDC) Power Path Management
 - Instant-On Works with No Battery or Deeply Discharged Battery
 - Ideal Diode Operation in Battery Supplement Mode
- High Integration Includes All MOSFETs, Current Sensing and Loop Compensation
- 58- μ A Low Battery Leakage Current with System Voltage Standby
- High Accuracy
 - $\pm 0.5\%$ Charge Voltage Regulation
 - $\pm 6\%$ at 1.2-A and 1.8-A Charge Current

Regulation

- $\pm 5\%$ at 0.5-A, 1.2-A and 1.8-A Input Current Regulation

- Create a Custom Design Using the bq25606 With the [WEBENCH® Power Designer](#)

2 Applications

- EPOS, Portable Speakers, E-Cigarette
- Portable Internet Devices and Accessory

3 Description

The bq25606 device a highly-integrated standalone 3.0-A switch-mode battery charge management and system power path management device for single cell Li-Ion and Li-polymer battery. The low impedance power path optimizes switch-mode operation efficiency, reduces battery charging time and extends battery life during discharging phase.

Device Information⁽¹⁾

PART NUMBER	PACKAGE	BODY SIZE (NOM)
bq25606	VQFN (24)	4.00 mm x 4.00 mm

(1) For all available packages, see the orderable addendum at the end of the data sheet.

Simplified Application

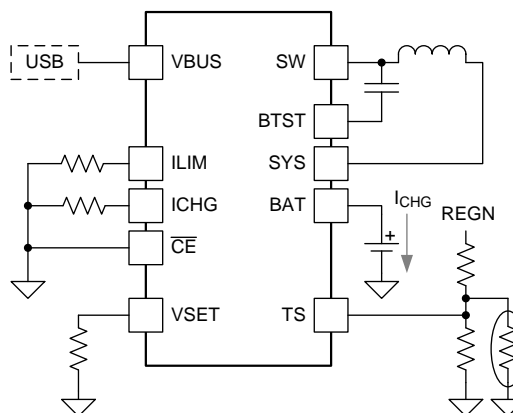

Table of Contents

1 Features	1	8.3 Feature Description.....	17
2 Applications	1	9 Application and Implementation	25
3 Description	1	9.1 Application information.....	25
4 Revision History	2	9.2 Typical Application Diagram	26
5 Description (continued)	3	9.3 Application Curves	28
6 Pin Configuration and Functions	4	10 Power Supply Recommendations	33
7 Specifications	6	11 Layout	34
7.1 Absolute Maximum Ratings	6	11.1 Layout Guidelines	34
7.2 ESD Ratings.....	6	11.2 Layout Example	34
7.3 Recommended Operating Conditions.....	6	12 Device and Documentation Support	36
7.4 Thermal information	7	12.1 Documentation Support	36
7.5 Timing Requirements	7	12.2 Community Resources.....	36
7.6 Electrical Characteristics.....	7	12.3 Trademarks	36
7.7 Typical Characteristics	13	12.4 Electrostatic Discharge Caution.....	36
8 Detailed Description	15	12.5 Glossary	36
8.1 Overview	15	13 Mechanical, Packaging, and Orderable Information	37
8.2 Functional Block Diagram	16		

4 Revision History

NOTE: Page numbers for previous revisions may differ from page numbers in the current version.

Changes from Original (May 2017) to Revision A	Page
• Updated data sheet title	1
• Deleted 200 nS Fast Turn-Off in <i>Features</i>	1
• Updated <i>Simplified Application</i> schematic.....	1
• Changed ACDRV pin references to "NC" in <i>Pin Configuration and Functions</i> section.....	4
• Deleted ACDRV pin references from <i>Pin Functions</i> table.....	4
• Updated VAC pin description in <i>Pin Functions</i> table.....	5
• Deleted ACDRV pin references from <i>Absolute Maximum Ratings</i> table.....	6
• Added <i>ESD Ratings</i> table.....	6
• Deleted VAC debounce time from <i>Timing Requirements</i> table.....	7
• Updated <i>Functional Block Diagram</i>	16
• Updated <i>Power Up from Input Source</i> section	17
• Deleted <i>Power Up OVPFET</i> section.....	17
• Deleted <i>OVPFET Startup Control</i> timing illustration	17
• Updated <i>Input Overvoltage (ACOV)</i> section.....	24
• Updated <i>bq25606 Application Diagram</i> schematic.....	26

5 Description (continued)

The bq25606 highly-integrated standalone 3.0-A switch-mode battery charge management and system power path management device for single cell Li-Ion and Li-polymer battery. It features fast charging with high input voltage support for a wide range of standalone chargers and portable devices. Its low impedance power path optimizes switch-mode operation efficiency, reduces battery charging time and extends battery life during discharging phase. Its input voltage and current regulation deliver maximum charging power to battery. The solution is highly integrated with input reverse-blocking FET (RBFET, Q1), high-side switching FET (HSFET, Q2), low-side switching FET (LSFET, Q3), and battery FET (BATFET, Q4) between system and battery. It also integrates the bootstrap diode for the high-side gate drive for simplified system design.

The device supports a wide range of input sources, including standard USB host port, USB charging port, and USB compliant high voltage adapter. The device sets default input current limit based on the built-in USB interface. The device is compliant with USB 2.0 and USB 3.0 power spec with input current and voltage regulation. When the device built-in USB interface identifies the input adaptor is unknown, the device's input current limit is determined by the ILIM pin setting resistor value. The device also meets USB On-the-Go (OTG) operation power rating specification by supplying 5.15 V on VBUS with constant current limit up to 1.2A.

The power path management regulates the system slightly above battery voltage but does not drop below 3.5 V minimum system voltage. With this feature, the system maintains operation even when the battery is completely depleted or removed. When the input current limit or voltage limit is reached, the power path management automatically reduces the charge current to zero. As the system load continues to increase, the power path discharges the battery until the system power requirement is met. This Supplement Mode prevents overloading the input source.

The device initiates and completes a charging cycle without software control. It senses the battery voltage and charges the battery in three phases: pre-conditioning, constant current and constant voltage. At the end of the charging cycle, the charger automatically terminates when the charge current is below a preset limit and the battery voltage is higher than recharge threshold. If the fully charged battery falls below the recharge threshold, the charger automatically starts another charging cycle.

The charger provides various safety features for battery charging and system operations, including battery negative temperature coefficient thermistor monitoring, charging safety timer and overvoltage and overcurrent protections. The thermal regulation reduces charge current when the junction temperature exceeds 110°C. The STAT output reports the charging status and any fault conditions. Other safety features include battery temperature sensing for charge and boost mode, thermal regulation and thermal shutdown and input UVLO and overvoltage protection.

The device family is available in 24-pin, 4 mm x 4 mm QFN package.

6 Pin Configuration and Functions

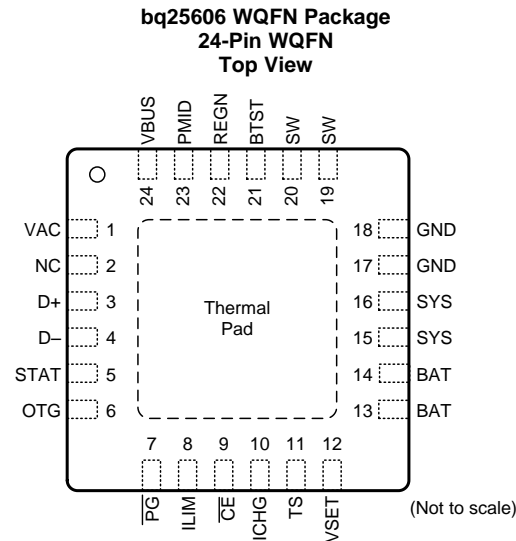

Terminal		I/O	Description
Name	No.		
NC	2		No connection. This pin must be floating.
BAT	13	P	Battery connection point to the positive terminal of the battery pack. The internal current sensing resistor is connected between SYS and BAT. Connect a 10 μ F closely to the BAT pin.
	14		
BTST	21	P	PWM high side driver positive supply. Internally, the BTST is connected to the cathode of the boost-strap diode. Connect the 0.047- μ F bootstrap capacitor from SW to BTST.
$\overline{\text{CE}}$	9	DI	Charge enable pin. When this pin is driven low, battery charging is enabled.
D+	3	AIO	Positive line of the USB data line pair. D+/D– based USB host/charging port detection. The detection includes data contact detection (DCD), primary and secondary detection in BC1.2 and nonstandard adaptors
D–	4	AIO	Negative line of the USB data line pair. D+/D– based USB host/charging port detection. The detection includes data contact detection (DCD), primary and secondary detection in BC1.2 and nonstandard adaptors
GND	17		Power ground and signal ground
	18		
ICHG	10	AI	I_{CHG} pin sets the charge current limit. A resistor is connected from I_{CHG} pin to ground to set charge current limit as $I_{\text{CHG}} = K_{\text{ICHG}}/R_{\text{ICHG}}$. The acceptable range for charge current is 300 mA – 3000 mA.
ILIM	8	AI	ILIM sets the input current limit. A resistor is connected from ILIM pin to ground to set the input current limit as $I_{\text{INDPM}} = K_{\text{ILIM}}/R_{\text{ILIM}}$. The acceptable range for ILIM current is 500 mA - 3200 mA. The resistor based input current limit is effective only when the input adapter is detected as unknown. Otherwise, the input current limit is determined by D+/D– detection outcome.
OTG	6	DI	Boost mode enable pin. When this pin is pulled HIGH, OTG is enabled. OTG cannot be floating.
$\overline{\text{PG}}$	7	DO	Open drain active low power good indicator. Connect to the pull up rail through 10 k Ω resistor. LOW indicates a good input if the input voltage is between UVLO and ACOV, above SLEEP mode threshold, and input current limit is above 30 mA.
PMID	23	P	Connected to the drain of the reverse blocking MOSFET (RBFET) and the drain of HSFET. Put a 10 - μ F ceramic capacitor between PMID and GND.
REGN	22	P	PWM low side driver positive supply output. Internally, REGN is connected to the anode of the boost-strap diode. Connect a 4.7- μ F (10-V rating) ceramic capacitor from REGN to analog GND. The capacitor should be placed close to the IC.

(continued)

Terminal		I/O	Description
Name	No.		
STAT	5	DO	Open-drain interrupt output. Connect the STAT pin to a logic rail via 10-k Ω resistor. The STAT pin indicates charger status. Charge in progress: LOW Charge complete or charger in SLEEP mode: HIGH Charge suspend (fault response): Blink at 1Hz
SW	19	P	Switching node connecting to output inductor. Internally SW is connected to the source of the n-channel HSFET and the drain of the n-channel LSFET. Connect the 0.047- μ F bootstrap capacitor from SW to BTST.
	20		
SYS	15	P	Converter output connection point. The internal current sensing resistor is connected between SYS and BAT. Connect a 20 μ F capacitor close to the SYS pin.
	16		
TS	11	AI	Temperature qualification voltage input to support JEITA profile. Connect a negative temperature coefficient thermistor. Program temperature window with a resistor divider from REGN to TS to GND. Charge suspends when TS pin voltage is out of range. Recommend 103AT-2 thermistor.
VAC	1	AI	Input voltage sensing. This pin must be shorted to VBUS pin.
VBUS	24	P	Charger input voltage. The internal n-channel reverse block MOSFET (RBFET) is connected between VBUS and PMID with VBUS on source. Place a 1-uF ceramic capacitor from VBUS to GND and place it as close as possible to IC.
VSET	12	AI	VSET pin sets default battery charge voltage in bq25606. Program battery regulation voltage with a resistor pull-down from VSET to GND. $R_{PD} > 50k\Omega$ (float pin) = 4.208 V $R_{PD} < 500\Omega$ (short to GND) = 4.352 V $5k\Omega < R_{PD} < 25k\Omega$ = 4.400 V
Thermal Pad		P	Ground reference for the device that is also the thermal pad used to conduct heat from the device. This connection serves two purposes. The first purpose is to provide an electrical ground connection for the device. The second purpose is to provide a low thermal-impedance path from the device die to the PCB. This pad should be tied externally to a ground plane.

7 Specifications

7.1 Absolute Maximum Ratings

over operating free-air temperature range (unless otherwise noted)⁽¹⁾

		MIN	MAX	UNIT
Voltage Range (with respect to GND)	VAC	-2	22	V
Voltage Range (with respect to GND)	VBUS (converter not switching) ⁽²⁾	-2	22	V
Voltage Range (with respect to GND)	BTST, PMID (converter not switching) ⁽²⁾	-0.3	22	V
Voltage Range (with respect to GND)	SW	-2	16	V
Voltage Range (with respect to GND)	BTST to SW	-0.3	7	V
Voltage Range (with respect to GND)	D+, D-	-0.3	7	V
Voltage Range (with respect to GND)	REGN, TS, \overline{CE} , \overline{PG} , BAT, SYS (converter not switching)	-0.3	7	V
Output Sink Current	STAT		6	mA
Voltage Range (with respect to GND)	VSET, ILIM, ICHG, OTG	-0.3	7	V
Voltage Range (with respect to GND)	PGND to GND (QFN package only)	-0.3	0.3	V
Operating junction temperature, T _J		-40	150	°C
Storage temperature, T _{stg}		-65	150	°C

- (1) Stresses beyond those listed under Absolute maximum Ratings may cause permanent damage to the device. These are stress ratings only, which do not imply functional operation of the device at these or any other conditions beyond those indicated under Recommended Operating Conditions. Exposure to absolute-maximum-rated conditions for extended periods may affect device reliability. All voltage values are with respect to the network ground terminal unless otherwise noted.
- (2) VBUS is specified up to 22 V for a maximum of one hour at room temperature

7.2 ESD Ratings

			VALUE	UNIT
V _(ESD)	Electrostatic discharge	Human body model (HBM), per ANSI/ESDA/JEDEC JS-001, all pins ⁽¹⁾	±2000	V
		Charged device model (CDM), per JEDEC specification JESD22-C101, all pins ⁽²⁾	±250	

- (1) JEDEC document JEP155 states that 500-V HBM allows safe manufacturing with a standard ESD control process.
- (2) JEDEC document JEP157 states that 250-V CDM allows safe manufacturing with a standard ESD control process.

7.3 Recommended Operating Conditions

		MIN	NOM	MAX	UNIT
V _{BUS}	Input voltage	3.9		13.5 ⁽¹⁾	V
I _{in}	Input current (VBUS)			3.25	A
I _{SYSOP}	Output current (SW)			3.0	A
V _{BATOP}	Battery voltage			4.4	V
I _{BATOP}	Fast charging current			3.0	A
I _{BATOP}	Discharging current (continuous)			6	A
T _A	Operating ambient temperature	-40		85	°C

- (1) The inherent switching noise voltage spikes should not exceed the absolute maximum voltage rating on either the BTST or SW pins. A tight layout minimizes switching noise.

7.4 Thermal information

THERMAL METRIC		bq25606	
		RGE (VQFN)	
		24 Pins	
			UNIT
$R_{\theta JA}$	Junction-to-ambient thermal resistance	31.9	°C/W
$R_{\theta JC(top)}$	Junction-to-case (top) thermal resistance	27	°C/W
$R_{\theta JB}$	Junction-to-board thermal resistance	9.2	°C/W
Ψ_{JT}	Junction-to-top characterization parameter	0.4	°C/W
Ψ_{JB}	Junction-to-board characterization parameter	9.2	°C/W
$R_{\theta JC(bot)}$	Junction-to-case (bottom) thermal resistance	2.8	°C/W

7.5 Timing Requirements

Parameter	Additional infor mAction	Min	NOM	mAX	UNIT	
VBUS/BAT POWER UP						
t_{ACOV}	VBUS OVP reaction time	VAC rising above ACOV threshold to turn off Q2		200	ns	
t_{BADSRC}	Bad adapter detection duration			30	ms	
t_{TERM_DGL}	Deglintch time for charge termination			250	ms	
t_{RECHG_DGL}	Deglintch time for recharge			250	ms	
$t_{SYSOVLD_DGL}$	System over-current deglintch time to turn off Q4			100	µs	
t_{BATOVP}	Battery overvoltage deglintch time to disable charge			1	µs	
t_{SAFETY}	Typical Charge Safety Timer Range		8	10	12	hr

7.6 Electrical Characteristics

$V_{VAC_PRESENT} < V_{VAC} < V_{VAC_OV}$ and $V_{VAC} > V_{BAT} + V_{SLEEP}$, $T_J = -40^{\circ}\text{C}$ to 125°C and $T_J = 25^{\circ}\text{C}$ for typical values (unless otherwise noted)

PARAMETER	TEST CONDITIONS	MIN	TYP	MAX	UNIT	
QUIESCENT CURRENTS						
I_{BAT}	Battery discharge current (BAT, SW, SYS) in buck mode	$V_{BAT} = 4.5\text{ V}$, $V_{BUS} < V_{AC-UVLOZ}$, leakage between BAT and VBUS, $T_J < 85^{\circ}\text{C}$		5	µA	
I_{BAT}	Battery discharge current (BAT, SW, SYS)	$V_{BAT} = 4.5\text{ V}$, No VBUS, $T_J < 85^{\circ}\text{C}$		58	85	µA
I_{VBUS}	Input supply current (VBUS) in buck mode	$V_{VBUS} = 12\text{ V}$, $V_{VBUS} > V_{VBAT}$, converter not switching		1.5	3	mA
I_{VBUS}	Input supply current (VBUS) in buck mode	$V_{VBUS} > V_{UVLO}$, $V_{VBUS} > V_{VBAT}$, converter switching, $V_{BAT} = 3.8\text{ V}$, $I_{SYS} = 0\text{ A}$		3		mA
I_{BOOST}	Battery discharge current in boost mode	$V_{BAT} = 4.2\text{ V}$, boost mode, $I_{VBUS} = 0\text{ A}$, converter switching		3		mA
VBUS, VAC AND BAT PIN POWER-UP						
V_{BUS_OP}	VBUS operating range	V_{VBUS} rising	3.9		13.5	V
$V_{VAC_PRESENT}$	REGN turn-on threshold	V_{VAC} rising	3.36	3.65	3.97	V
$V_{VAC_PRESENT_HYS}$		V_{VAC} falling		300		mV
V_{SLEEP}	Sleep mode falling threshold	$(V_{VAC} - V_{VBAT})$, $V_{BUSMIN_FALL} \leq V_{BAT} \leq V_{REG}$, VAC falling	37	76	126	mV
V_{SLEEPZ}	Sleep mode rising threshold	$(V_{VAC} - V_{VBAT})$, $V_{BUSMIN_FALL} \leq V_{BAT} \leq V_{REG}$, VAC rising	130	220	350	mV
$V_{VAC_OV_RISE}$	VAC Overvoltage rising threshold	VAC rising	13.5	14.28	14.91	V
$V_{VAC_OV_HYS}$	VAC Overvoltage hysteresis	VAC falling		520		mV

Electrical Characteristics (continued)

$V_{VAC_PRESENT} < V_{VAC} < V_{VAC_OV}$ and $V_{VAC} > V_{BAT} + V_{SLEEP}$, $T_J = -40^{\circ}\text{C}$ to 125°C and $T_J = 25^{\circ}\text{C}$ for typical values (unless otherwise noted)

PARAMETER	TEST CONDITIONS	MIN	TYP	MAX	UNIT	
$V_{BAT_DPL_FALL}$	Battery depletion falling threshold (Q4 turn-off threshold)	V_{BAT} falling	2.15		2.6	V
$V_{BAT_DPL_RISE}$	Battery Depletion rising threshold (Q4 turn-on threshold)	V_{BAT} rising	2.35		2.82	V
$V_{BAT_DPL_HYST}$	Battery Depletion rising hysteresis	V_{BAT} rising		180		mV
V_{BUSMIN_FALL}	Bad adapter detection falling threshold	V_{BUS} falling	3.65	3.8	3.93	V
V_{BUSMIN_HYST}	Bad adapter detection hysteresis			200		mV
I_{BADSRC}	Bad adapter detection current source	Sink current from V_{BUS} to GND		30		mA
POWER-PATH						
V_{SYS_MIN}	System regulation voltage	$V_{VBAT} < V_{SYS_MIN} = 3.5\text{V}$, charge enabled or disabled	3.5	3.68		V
V_{SYS}	System regulation voltage	$I_{SYS} = 0\text{ A}$, $V_{VBAT} > V_{SYSMIN}$, charge disabled		$V_{BAT} + 50\text{ mV}$		V
$R_{ON(RBFET)}$	Top reverse blocking MOSFET on-resistance between V_{BUS} and PMID - Q1	$-40^{\circ}\text{C} \leq T_A \leq 125^{\circ}\text{C}$		45		m Ω
$R_{ON(HSFET)}$	Top switching MOSFET on-resistance between PMID and SW - Q2	$V_{REGN} = 5\text{ V}$, $-40^{\circ}\text{C} \leq T_A \leq 125^{\circ}\text{C}$		62		m Ω
$R_{ON(LSFET)}$	Bottom switching MOSFET on-resistance between SW and GND - Q3	$V_{REGN} = 5\text{ V}$, $-40^{\circ}\text{C} \leq T_A \leq 125^{\circ}\text{C}$		70		m Ω
V_{FWD}	BATFET forward voltage in supplement mode			30		mV
$R_{ON(BAT-SYS)}$	SYS-BAT MOSFET on-resistance	QFN package, Measured from BAT to SYS, $V_{BAT} = 4.2\text{V}$, $T_J = 25^{\circ}\text{C}$		19.5	24	m Ω
$R_{ON(BAT-SYS)}$	SYS-BAT MOSFET on-resistance	QFN package, Measured from BAT to SYS, $V_{BAT} = 4.2\text{V}$, $T_J = -40 - 125^{\circ}\text{C}$		19.5	30	m Ω
BATTERY CHARGER						
V_{BATREG}	Charge voltage	$R_{VSET} > 50\text{ k}\Omega$, $-40 \leq T_J \leq 85^{\circ}\text{C}$	4.187	4.208	4.229	V
		$R_{VSET} < 500\ \Omega$, $-40 \leq T_J \leq 85^{\circ}\text{C}$	4.330	4.352	4.374	V
		$R_{VSET} = 10\text{ k}\Omega$, $-40 \leq T_J \leq 85^{\circ}\text{C}$	4.378	4.4	4.422	V
V_{BATREG_ACC}	Charge voltage setting accuracy	$V_{BAT} = 4.208\text{ V}$ or $V_{BAT} = 4.352\text{ V}$, $-40 \leq T_J \leq 85^{\circ}\text{C}$	-0.5%		0.5%	
$I_{CHG_REG_RANGE}$	Charge current regulation range		0		3000	mA
I_{CHG_REG}	Charge current regulation	$R_{ICHG} = 1100\ \Omega$, $V_{VBAT} = 3.1\text{ V}$ or $V_{VBAT} = 3.8\text{ V}$	516	615	715	mA
$I_{CHG_REG_ACC}$	Charge current regulation accuracy	$R_{ICHG} = 1100\ \Omega$, $V_{VBAT} = 3.1\text{ V}$ or $V_{VBAT} = 3.8\text{ V}$	-16%		16%	
I_{CHG_REG}	Charge current regulation	$R_{ICHG} = 562\ \Omega$, $V_{VBAT} = 3.1\text{ V}$ or $V_{VBAT} = 3.8\text{ V}$	1.14	1.218	1.28	A
I_{CHG_REG}	Charge current regulation accuracy	$R_{ICHG} = 562\ \Omega$, $V_{VBAT} = 3.1\text{ V}$ or $V_{VBAT} = 3.8\text{ V}$	-6%		6%	
I_{CHG_REG}	Charge current regulation	$R_{ICHG} = 372\ \Omega$, $V_{VBAT} = 3.1\text{ V}$ or $V_{VBAT} = 3.8\text{ V}$	1.715	1.813	1.89	A
$I_{CHG_REG_ACC}$	Charge current regulation accuracy	$R_{ICHG} = 372\ \Omega$, $V_{VBAT} = 3.1\text{ V}$ or $V_{VBAT} = 3.8\text{ V}$	-5%		5%	
K_{ICHG}	Charge current regulation setting ratio	$R_{ICHG} = 372\ \Omega$, $562\ \Omega$ $V_{VBAT} = 3.1\text{ V}$ or $V_{VBAT} = 3.8\text{ V}$	639	677	715	Ax Ω
K_{ICHG_ACC}	Charge current regulation setting ratio accuracy	$R_{ICHG} = 372\ \Omega$, $562\ \Omega$ $V_{VBAT} = 3.1\text{ V}$ or $V_{VBAT} = 3.8\text{ V}$	-6%		6%	
$V_{BATLOWV_FALL}$	Battery LOWV falling threshold	Fast charge to precharge	2.67	2.8	2.87	V

Electrical Characteristics (continued)

$V_{VAC_PRESENT} < V_{VAC} < V_{VAC_OV}$ and $V_{VAC} > V_{BAT} + V_{SLEEP}$, $T_J = -40^{\circ}\text{C}$ to 125°C and $T_J = 25^{\circ}\text{C}$ for typical values (unless otherwise noted)

	PARAMETER	TEST CONDITIONS	MIN	TYP	MAX	UNIT
$V_{BATLOWV_RISE}$	Battery LOWV rising threshold	Pre-charge to fast charge	3.0	3.1	3.24	V
I_{PRECHG}	Precharge current regulation	$R_{ICHG} = 1100\ \Omega$, $V_{VBAT} = 2.6\ \text{V}$, $I_{PRECHG} = 5\%$ of $I_{CHG} = 615\text{mA}$	21		38	mA
I_{PRECHG_ACC}	Precharge current regulation accuracy	Percentage of I_{CHG} , $R_{ICHG} = 1100\ \Omega$, $V_{VBAT} = 2.6\ \text{V}$, $I_{CHG} = 615\text{mA}$	3.4%		6.2%	
I_{PRECHG}	Precharge current regulation	$R_{ICHG} = 562\ \Omega$, $V_{VBAT} = 2.6\ \text{V}$, $I_{PRECHG} = 5\%$ of $I_{CHG} = 1.218\text{A}$	48		67	mA
I_{PRECHG_ACC}	Precharge current regulation accuracy	Percentage of I_{CHG} , $R_{ICHG} = 562\ \Omega$, $V_{VBAT} = 2.6\ \text{V}$, $I_{CHG} = 1.218\text{A}$	3.9%		5.5%	
I_{PRECHG}	Precharge current regulation	$R_{ICHG} = 372\ \Omega$, $V_{VBAT} = 2.6\ \text{V}$, $I_{PRECHG} = 5\%$ of $I_{CHG} = 1.813\text{A}$	76		97	mA
I_{PRECHG_ACC}	Precharge current regulation accuracy	Percentage of I_{CHG} , $R_{ICHG} = 372\ \Omega$, $V_{VBAT} = 2.6\ \text{V}$, $I_{CHG} = 1.813\text{A}$	4.1%		5.4%	
I_{TERM}	Termination current regulation	$R_{ICHG} = 562\ \Omega$, $V_{VBAT} = 4.35\text{V}$, $I_{CHG} = 1.218\text{A}$	26		100	mA
I_{TERM_ACC}	Termination current regulation accuracy	Percentage of I_{CHG} , $R_{ICHG} = 562\ \Omega$, $V_{VBAT} = 4.35\ \text{V}$, $I_{CHG} = 1.218\ \text{A}$	2.1%		8.3%	
I_{TERM}	Termination current regulation	$R_{ICHG} = 372\ \Omega$, $V_{VBAT} = 4.35\ \text{V}$, $I_{CHG} = 1.813\ \text{A}$	56	100	126	mA
I_{TERM_ACC}	Termination current regulation accuracy	Percentage of I_{CHG} , $R_{ICHG} = 372\ \Omega$, $V_{VBAT} = 4.35\ \text{V}$, $I_{CHG} = 1.813\ \text{A}$	3.0%		7.0%	
V_{SHORT}	Battery short voltage	V_{VBAT} falling	1.85	2	2.15	V
V_{SHORTZ}	Battery short voltage	V_{VBAT} rising	2.05	2.25	2.35	V
I_{SHORT}	Battery short current	$V_{VBAT} < V_{SHORTZ}$	70	90	110	mA
V_{RECHG}	Recharge Threshold below V_{BAT_REG}	V_{BAT} falling	87	121	156	mV
$I_{SYSLOAD}$	System discharge load current	$V_{SYS} = 4.2\ \text{V}$		30		mA
INPUT VOLTAGE AND CURRENT REGULATION						
V_{DPM_VBAT}	Input voltage regulation limit	$V_{VBAT} < 4.1\ \text{V}$ ($V_{VBAT} = 3.6\ \text{V}$)	4.171	4.3	4.429	V
$V_{DPM_VBAT_ACC}$	Input voltage regulation accuracy	$V_{VBAT} < 4.1\ \text{V}$ ($V_{VBAT} = 3.6\ \text{V}$)	-3%		3%	
I_{INDPM}	USB input current regulation limit	$V_{VBUS} = 5\ \text{V}$, USB500 charge port detected by DPDM, $-40 \leq T_J \leq 85^{\circ}\text{C}$	448		500	mA
I_{INDPM}	Input current regulation limit	$R_{ILIM} = 910\ \Omega$, unknown adaptor detected by DPDM, $-40 \leq T_J \leq 85^{\circ}\text{C}$	505	526	550	mA
I_{INDPM}	Input current regulation limit accuracy	$R_{ILIM} = 374\ \Omega$, unknown adaptor detected by DPDM, $-40 \leq T_J \leq 85^{\circ}\text{C}$	1220	1276	1330	mA
I_{INDPM}	Input current regulation limit	$R_{ILIM} = 265\ \Omega$, unknown adaptor detected by DPDM, $-40 \leq T_J \leq 85^{\circ}\text{C}$	1.73	1.8	1.871	A
I_{INDPM_ACC}	Input current regulation limit accuracy	$R_{ILIM} = 265\ \Omega$, $374\ \Omega$, $910\ \Omega$, unknown adaptor detected by DPDM, $-40 \leq T_J \leq 85^{\circ}\text{C}$	-5%		5%	
K_{ILIM}	Input current setting ratio, $I_{LIM} = K_{ILIM} / R_{ILIM}$	$R_{ILIM} = 910\ \Omega$, $374\ \Omega$, $265\ \Omega$, unknown adaptor detected by DPDM, $-40 \leq T_J \leq 85^{\circ}\text{C}$	459	478	500	$\text{A} \times \Omega$
K_{ILIM_ACC}	Input current setting ratio, $I_{LIM} = K_{ILIM} / R_{ILIM}$	$R_{ILIM} = 910\ \Omega$, $374\ \Omega$, $265\ \Omega$, unknown adaptor detected by DPDM, $-40 \leq T_J \leq 85^{\circ}\text{C}$	-5%		5%	
I_{IN_START}	Input current limit during system start-up sequence			200		mA

Electrical Characteristics (continued)

$V_{VAC_PRESENT} < V_{VAC} < V_{VAC_OV}$ and $V_{VAC} > V_{BAT} + V_{SLEEP}$, $T_J = -40^{\circ}\text{C}$ to 125°C and $T_J = 25^{\circ}\text{C}$ for typical values (unless otherwise noted)

PARAMETER		TEST CONDITIONS	MIN	TYP	MAX	UNIT
BAT PIN OVERVOLTAGE PROTECTION						
V_{BATOVP_RISE}	Battery overvoltage threshold	V_{BAT} rising, as percentage of V_{BAT_REG}	103%	104%	105%	
V_{BATOVP_FALL}	Battery overvoltage threshold	V_{BAT} falling, as percentage of V_{BAT_REG}	101%	102%	103%	

Electrical Characteristics (continued)

$V_{VAC_PRESENT} < V_{VAC} < V_{VAC_OV}$ and $V_{VAC} > V_{BAT} + V_{SLEEP}$, $T_J = -40^{\circ}\text{C}$ to 125°C and $T_J = 25^{\circ}\text{C}$ for typical values (unless otherwise noted)

PARAMETER		TEST CONDITIONS	MIN	TYP	MAX	UNIT
THERMAL REGULATION AND THERMAL SHUTDOWN						
$T_{JUNCTION_REG}$	Junction Temperature Regulation Threshold			110		$^{\circ}\text{C}$
T_{SHUT}	Thermal Shutdown Rising Temperature	Temperature Increasing		160		$^{\circ}\text{C}$
T_{SHUT_HYST}	Thermal Shutdown Hysteresis			30		$^{\circ}\text{C}$
JEITA Thermistor Comparator (BUCK MODE)						
V_{T1}	T1 (0°C) threshold, Charge suspended T1 below this temperature.	Charger suspends charge. As Percentage to V_{REGN}	72.4%	73.3%	74.2%	
V_{T1}	Falling	As Percentage to V_{REGN}	69%	71.5%	74%	
V_{T2}	T2 (10°C) threshold, Charge back to $I_{CHG}/2$ and 4.2 V below this temperature	As percentage of V_{REGN}	67.2%	68%	69%	
V_{T2}	Falling	As Percentage to V_{REGN}	66%	66.8%	67.7%	
V_{T3}	T3 (45°C) threshold, charge back to I_{CHG} and 4.05V above this temperature.	Charger suspends charge. As Percentage to V_{REGN}	43.8%	44.7%	45.8%	
V_{T3}	Falling	As Percentage to V_{REGN}	45.1%	45.7%	46.2%	
V_{T5}	T5 (60°C) threshold, charge suspended above this temperature.	As Percentage to V_{REGN}	33.7%	34.2%	35.1%	
V_{T5}	Falling	As Percentage to V_{REGN}	34.5%	35.3%	36.2%	
COLD OR HOT THERMISTOR COMPARATOR (BOOST MODE)						
V_{BCOLD}	Cold Temperature Threshold, TS pin Voltage Rising Threshold	As Percentage to V_{REGN} (Approx. -20°C w/ 103AT), $-20^{\circ}\text{C} \leq T_J \leq 125^{\circ}\text{C}$	79.5%	80%	80.5%	
V_{BCOLD}	Falling	$-20^{\circ}\text{C} \leq T_J \leq 125^{\circ}\text{C}$	78.5%	79%	79.5%	
V_{BHOT}	Hot Temperature Threshold, TS pin Voltage falling Threshold	As Percentage to V_{REGN} (Approx. 60°C w/ 103AT), $-20^{\circ}\text{C} \leq T_J \leq 125^{\circ}\text{C}$	30.2%	31.2%	32.2%	
V_{BHOT}	Rising	$-20^{\circ}\text{C} \leq T_J \leq 125^{\circ}\text{C}$	33.8%	34.4%	34.9%	

Electrical Characteristics (continued)

$V_{VAC_PRESENT} < V_{VAC} < V_{VAC_OV}$ and $V_{VAC} > V_{BAT} + V_{SLEEP}$, $T_J = -40^{\circ}\text{C}$ to 125°C and $T_J = 25^{\circ}\text{C}$ for typical values (unless otherwise noted)

PARAMETER		TEST CONDITIONS	MIN	TYP	MAX	UNIT
CHARGE OVERCURRENT COMPARATOR (CYCLE-BY-CYCLE)						
I_{HSFET_OCP}	HSFET cycle-by-cycle over-current threshold		5.2		8.0	A
I_{BATFET_OCP}	System over load threshold		6.0			A
PWM						
f_{SW}	PWM switching frequency	Oscillator frequency, buck mode	1320	1500	1680	kHz
		Oscillator frequency, boost mode	1170	1412	1500	kHz
D_{MAX}	Maximum PWM duty cycle ⁽¹⁾			97%		
BOOST MODE OPERATION						
V_{OTG_REG}	Boost mode regulation voltage	$V_{VBAT} = 3.8\text{ V}$, $I_{(PMID)} = 0\text{ A}$	4.972	5.126	5.280	V
$V_{OTG_REG_ACC}$	Boost mode regulation voltage accuracy	$V_{VBAT} = 3.8\text{ V}$, $I_{(PMID)} = 0\text{ A}$	-3		3	%
$V_{BATLOWV_OTG}$	Battery voltage exiting boost mode	V_{VBAT} falling	2.6	2.8	2.9	V
	Battery voltage entering boost mode	V_{VBAT} rising	2.9	3.0	3.15	V
I_{OTG}	OTG mode output current limit		1.2	1.4	1.6	A
V_{OTG_OVP}	OTG overvoltage threshold	Rising threshold	5.55	5.8	6.15	V
REGN LDO						
V_{REGN}	REGN LDO output voltage	$V_{VBUS} = 9\text{ V}$, $I_{REGN} = 40\text{ mA}$	5.6	6	6.65	V
V_{REGN}	REGN LDO output voltage	$V_{VBUS} = 5\text{ V}$, $I_{REGN} = 20\text{ mA}$	4.6	4.7	4.9	V
LOGIC I/O PIN CHARACTERISTICS (\overline{CE}, PSEL, SCL, SDA,, INT)						
V_{ILO}	Input low threshold \overline{CE}				0.4	V
V_{IH}	Input high threshold \overline{CE}		1.3			V
I_{BIAS}	High-level leakage current \overline{CE}	Pull up rail 1.8 V			1	μA
V_{ILO}	Input low threshold OTG				0.4	V
V_{IH}	Input high threshold OTG		1.3			V
I_{BIAS}	High-level leakage current OTG	Pull up rail 1.8 V			1	μA
LOGIC I/O PIN CHARACTERISTICS (\overline{PG}, STAT)						
V_{OL}	Low-level output voltage				0.4	V
D+/D- DETECTION						
V_{D+_1P2}	D+ Threshold for Non-standard adapter (combined V1P2_VTH_LO and V1P2_VTH_HI)		1.05		1.35	V
I_{D+_LKG}	Leakage current into D+	HiZ	-1		1	μA
$V_{D-_600MVSRC}$	Voltage source (600 mV)		500	600	700	mV
$I_{D-_100UAISNK}$	D- current sink (100 μA)	$V_{D-} = 500\text{ mV}$,	50	100	150	μA
R_{D-_19K}	D- resistor to ground (19 k Ω)	$V_{D-} = 500\text{ mV}$,	14.25		24.8	k Ω
V_{D-_0P325}	D- comparator threshold for primary detection	D- pin Rising	250		400	mV
V_{D-_2P8}	D- Threshold for non-standard adapter (combined V2P8_VTH_LO and V2P8_VTH_HI)		2.55		2.85	V
V_{D-_2P0}	D- Comparator threshold for non-standard adapter (For non-standard – same as bq2589x)		1.85		2.15	V
V_{D-_1P2}	D- Threshold for non-standard adapter (combined V1P2_VTH_LO and V1P2_VTH_HI)		1.05		1.35	V
I_{D-_LKG}	Leakage current into D-	HiZ	-1		1	μA

(1) Specified by design. Not production tested.

7.7 Typical Characteristics

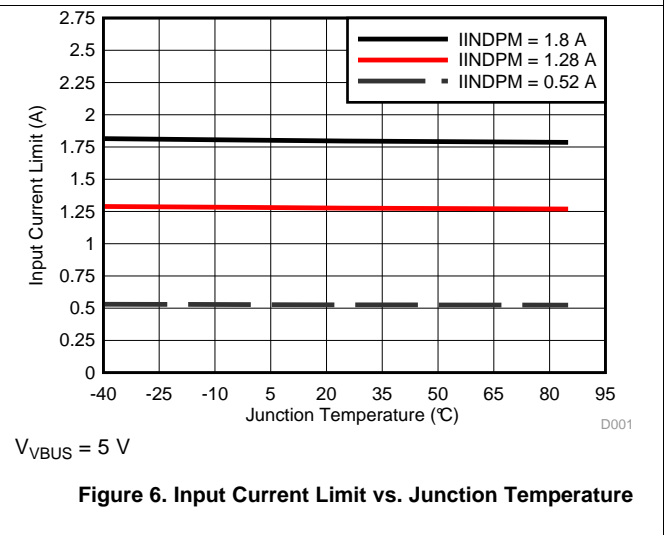
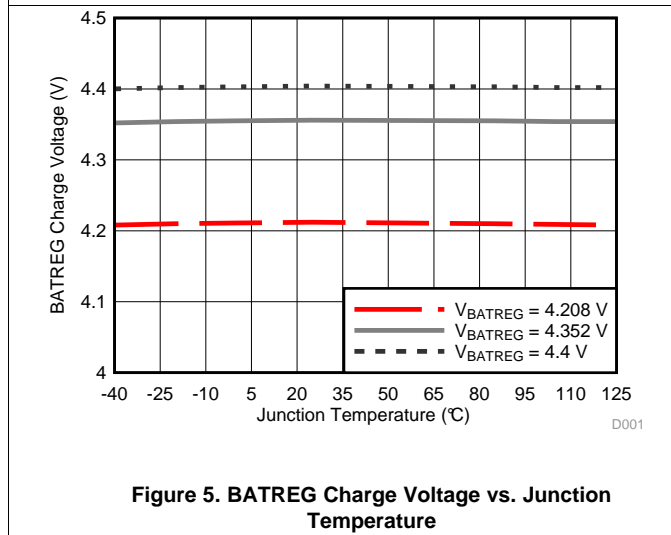
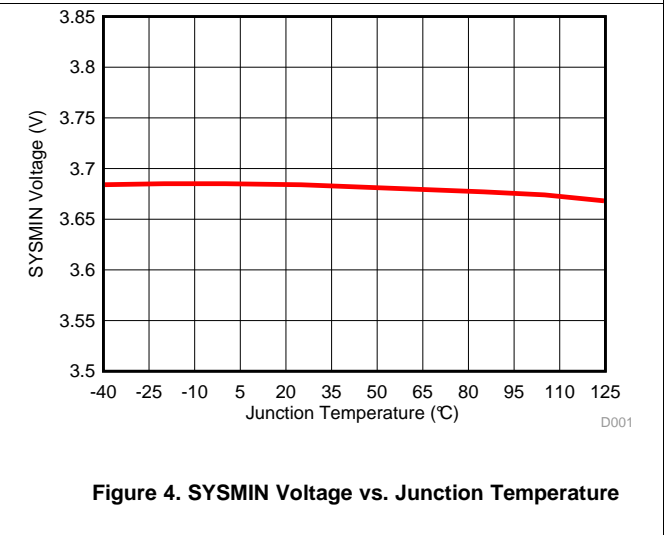
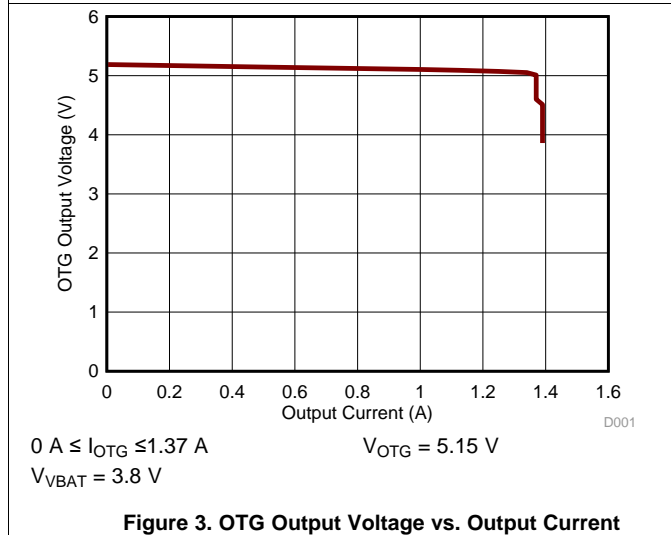
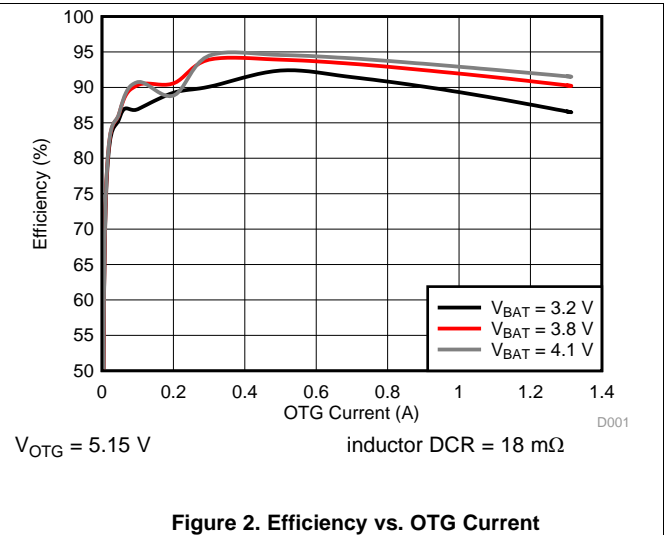
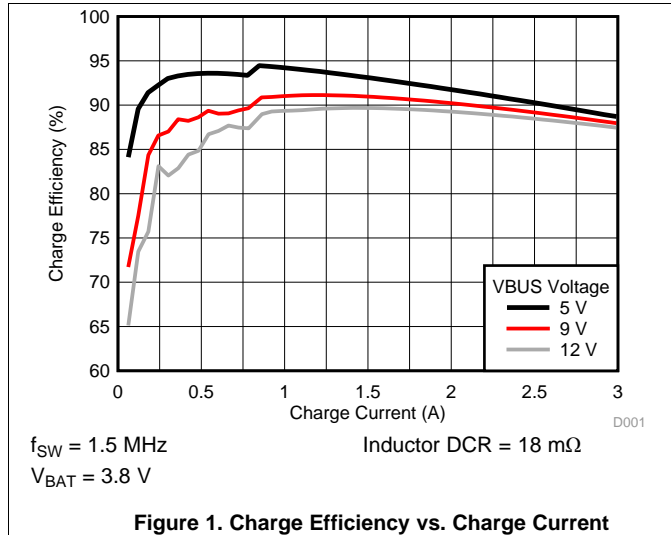

Typical Characteristics (continued)

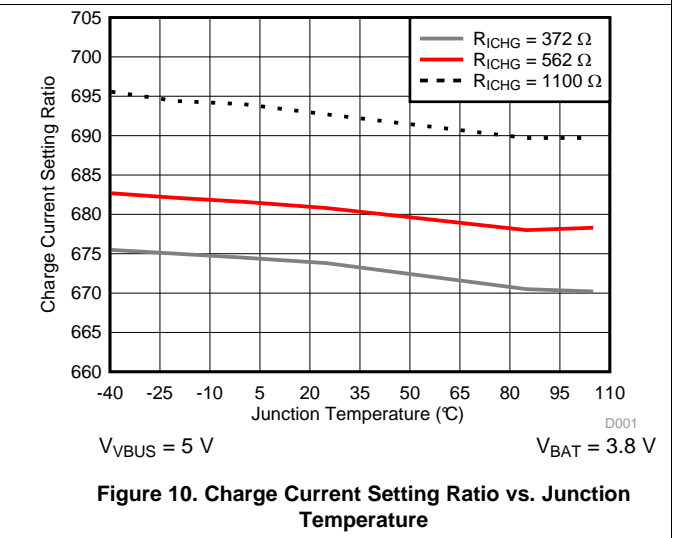
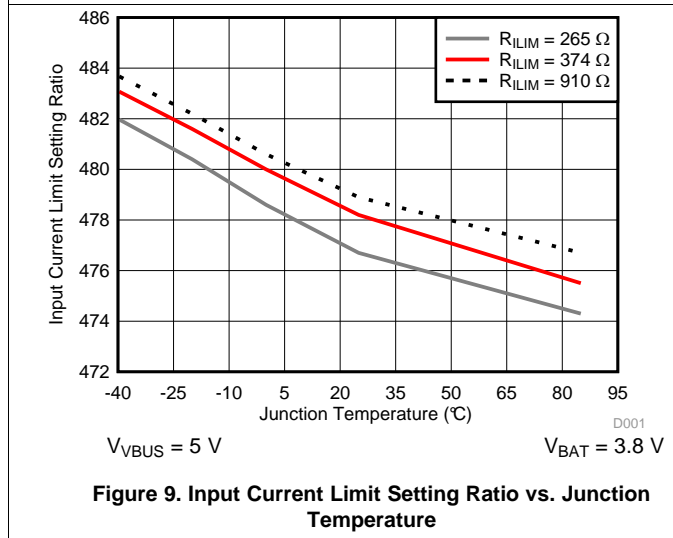
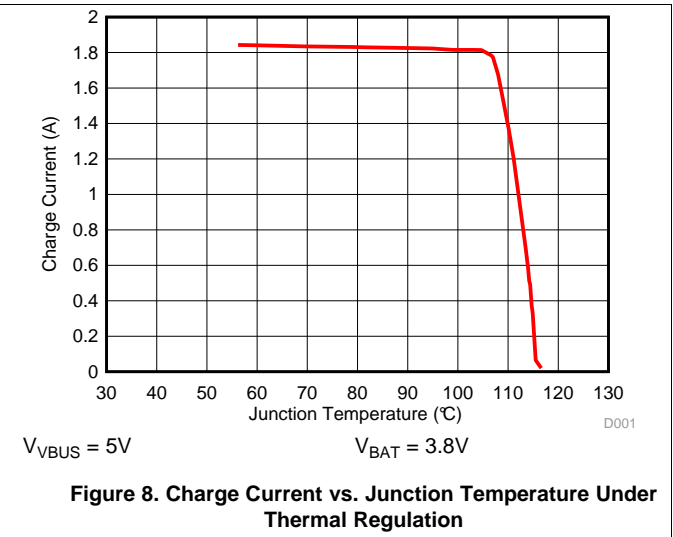
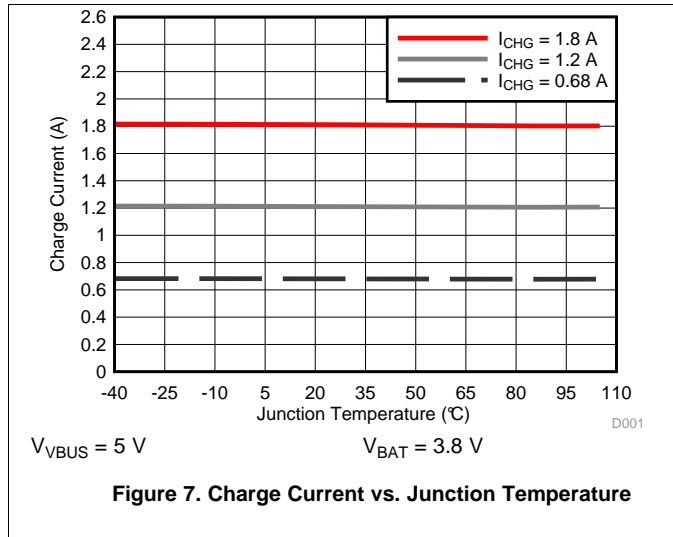

8 Detailed Description

8.1 Overview

The bq25606 device is a highly integrated 3.0-A switch-mode battery charger for single cell Li-Ion and Li-polymer battery. It includes the input reverse-blocking FET (RBFET, Q1), high-side switching FET (HSFET, Q2), low-side switching FET (LSFET, Q3), and battery FET (BATFET, Q4), and bootstrap diode for the high-side gate drive.

8.2 Functional Block Diagram

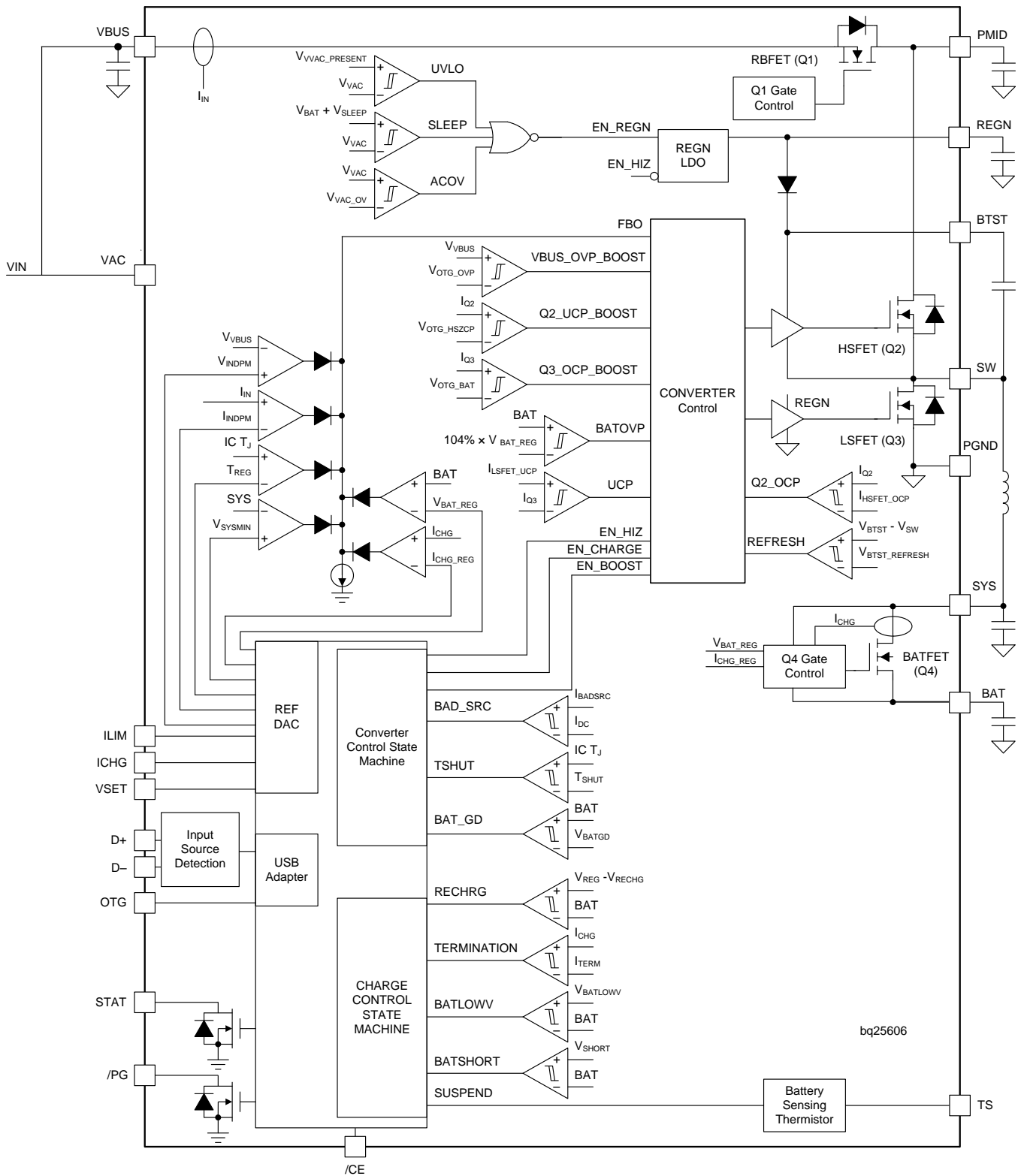

8.3 Feature Description

8.3.1 Device Power Up from Battery without Input Source

If only battery is present and the voltage is above depletion threshold ($V_{\text{BAT_DPL_RISE}}$), the BATFET turns on and connects battery to system. The REGN stays off to minimize the quiescent current. The low $R_{\text{DS(on)}}$ of BATFET and the low quiescent current on BAT minimize the conduction loss and maximize the battery run time.

The device always monitors the discharge current through BATFET (*Supplement Mode*). When the system is overloaded or shorted ($I_{\text{BAT}} > I_{\text{BATFET_OCP}}$), the device turns off BATFET immediately until the input source plugs in again.

8.3.2 Power Up from Input Source

When an input source is plugged in, the device checks the input source voltage to turn on REGN LDO and all the bias circuits. It detects and sets the input current limit before the buck converter is started. The power up sequence from input source is as listed:

1. Power Up REGN LDO
2. Poor Source Qualification
3. Input Source Type Detection is based on D+/D– to set input current limit (IINDPM) .
4. Input Voltage Limit Threshold Setting (VINDPM threshold)
5. Converter Power-up

8.3.2.1 Power Up REGN Regulation

The REGN LDO supplies internal bias circuits as well as the HSFET and LSFET gate drive. The REGN also provides bias rail to TS external resistors. The pull-up rail of STAT can be connected to REGN as well. The REGN is enabled when all the below conditions are valid:

- V_{VAC} above $V_{\text{VAC_PRESENT}}$
- V_{VAC} above $V_{\text{BAT}} + V_{\text{SLEEPZ}}$ in buck mode or V_{BUS} below $V_{\text{BAT}} + V_{\text{SLEEP}}$ in boost mode
- After 220-ms delay is completed

If any one of the above conditions is not valid, the device is in high impedance mode (HIZ) with REGN LDO off. The device draws less than $I_{\text{VBUS_HIZ}}$ from V_{BUS} during HIZ state. The battery powers up the system when the device is in HIZ.

8.3.2.2 Poor Source Qualification

After REGN LDO powers up, the device confirms the current capability of the input source. The input source must meet both of the following requirements in order to start the buck converter.

- VAC voltage below $V_{\text{VAC_OV}}$
- V_{BUS} voltage above V_{VBUSMIN} when pulling I_{BADSRC} (typical 30 mA)

If the device fails the poor source detection, it repeats poor source qualification every 2 seconds.

8.3.2.3 Input Source Type Detection

After the REGN LDO is powered, the device runs input source detection through D+/D– lines. The bq25606 follows the USB Battery Charging Specification 1.2 (BC1.2) to detect input source (SDP/ DCP) and non-standard adapter through USB D+/D– lines. The bq25606 sets input current limit through D+/D– detection and ILIM pins.

8.3.2.3.1 D+/D– Detection Sets Input Current Limit in bq25606

The bq25606 contains a D+/D– based input source detection to set the input current limit at V_{BUS} plug-in. The D+/D– detection includes standard USB BC1.2 and non-standard adapter. When input source is plugged in, the device starts standard USB BC1.2 detections. The USB BC1.2 is capable to identify Standard Downstream Port (SDP) and Dedicated Charging Port (DCP). When the Data Contact Detection (DCD) timer expires, the non-standard adapter detection is applied to set the input current limit. The non-standard detection is used to distinguish vendor specific adapters (Apple and Samsung) based on their unique dividers on the D+/D– pins. If an adapter is detected as DCP, the input current limit is set at 2.4 A. If an adapter is detected as unknown, the input current limit is set by ILIM pin.

Feature Description (continued)

Table 1. Non-Standard Adapter Detection

Non-Standard Adapter	D+ Threshold	D– Threshold	Input Current Limit (A)
Divider 1	V_{D+} within V_{2P7_VTH}	V_{D-} within V_{2P0_VTH}	2.1
Divider 2	V_{D+} within V_{1P2_VTH}	V_{D-} within V_{1P2_VTH}	2
Divider 3	V_{D+} within V_{2P0_VTH}	V_{D-} within V_{2P7_VTH}	1
Divider 4	V_{D+} within V_{2P7_VTH}	V_{D-} within V_{2P7_VTH}	2.4

Table 2. Input Current Limit Setting from D+/D– Detection

D+/D– Detection	Input Current Limit (IILIM)
USB SDP (USB500)	500 mA
USB DCP	2.4 A
Divider 3	1 A
Divider 1	2.1 A
Divider 4	2.4 A
Divider 2	2 A
Unknown 5-V Adapter	Set by ILIM pin

8.3.2.4 Input Voltage Limit Threshold Setting (VINDPM Threshold)

The device's VINDPM is set at 4.3V. The device supports dynamic VINDPM tracking which tracks the battery voltage. The device's VINDPM tracks battery voltage with 200mV offset such that when $V_{BAT} + 200mV$ is greater than 4.3V, the VINDPM value is automatically adjusted to $V_{BAT} + 200mV$.

8.3.2.5 Converter Power-Up

After the input current limit is set, the converter is enabled and the HSFET and LSFET start switching. If battery charging is disabled, BATFET turns off. Otherwise, BATFET stays on to charge the battery.

The device provides soft-start when system rail is ramped up. When the system rail is below 2.2 V, the input current is limited to is to 200 mA. After the system rises above 2.2 V, the device limits input current to the value set by ILIM pin.

As a battery charger, the device deploys a highly efficient 1.5 MHz step-down switching regulator. The fixed frequency oscillator keeps tight control of the switching frequency under all conditions of input voltage, battery voltage, charge current and temperature, simplifying output filter design.

The device switches to PFM control at light load or when battery is below minimum system voltage setting or charging is disabled.

8.3.3 Boost Mode Operation From Battery

The device supports boost converter operation to deliver power from the battery to other portable devices through USB port. The maximum output current is up to 1.2 A. The boost operation can be enabled if the conditions are valid:

1. BAT above V_{OTG_BAT}
2. VBUS less than $BAT + V_{SLEEP}$ (in sleep mode)
3. Boost mode operation is enabled (OTG pin HIGH)
4. Voltage at TS (thermistor) pin is within acceptable range ($V_{BHOT} < V_{TS} < V_{BCOLD}$)
5. After 30-ms delay from boost mode enable

During boost mode, the VBUS output is 5.15 V and the output current can reach up to 1.2 A. The boost output is maintained when BAT is above V_{OTG_BAT} threshold.

When OTG is enabled, the device starts up with PFM and later transits to PWM to minimize the overshoot.

8.3.4 Standalone Power Management

8.3.5 Power Path Management

The device accommodates a wide range of input sources from USB, wall adapter, to car charger. The device provides automatic power path selection to supply the system (SYS) from input source (VBUS), battery (BAT), or both.

8.3.6 Battery Charging Management

The device charges 1-cell Li-Ion battery with up to 3.0-A charge current for high capacity tablet battery. The 19.5-mΩ BATFET improves charging efficiency and minimize the voltage drop during discharging.

8.3.6.1 Autonomous Charging Cycle

With battery charging is enabled (\overline{CE} pin is LOW), the device autonomously completes a charging cycle. The device default charging parameters are listed in [Table 3](#).

Table 3. Charging Parameter Default Setting

Default Mode	bq25606
Charging voltage	VSET controlled
Charging current	I _{CHG} controlled
Pre-charge current	5% of I _{CHG}
Termination current	5% of I _{CHG}
Temperature profile	JEITA
Safety timer	10 hours

A new charge cycle starts when the following conditions are valid:

- Converter starts
- Battery charging is enabled (\overline{CE} is low)
- No thermistor fault on TS
- No safety timer fault

The charger device automatically terminates the charging cycle when the charging current is below termination threshold, battery voltage is above recharge threshold, and device not is in DPM mode or thermal regulation. When a fully charged battery is discharged below recharge threshold, the device automatically starts a new charging cycle. After the charge is done, toggle \overline{CE} pin can initiate a new charging cycle.

The STAT output indicates the charging status: charging (LOW), charging complete or charge disable (HIGH) or charging fault (Blinking).

8.3.6.2 Charging Termination

The device terminates a charge cycle when the battery voltage is above recharge threshold, and the current is below termination current. After the charging cycle is completed, the BATFET turns off. The converter keeps running to power the system, and BATFET can turn on again to engage *Supplement Mode*.

8.3.6.3 Thermistor Qualification

The charger device provides a single thermistor input for battery temperature monitor.

8.3.6.4 JEITA Guideline Compliance During Charging Mode

To improve the safety of charging Li-ion batteries, JEITA guideline was released on April 20, 2007. The guideline emphasized the importance of avoiding a high charge current and high charge voltage at certain low and high temperature ranges.

To initiate a charge cycle, the voltage on TS pin must be within the VT1 to VT5 thresholds. If TS voltage exceeds the T1-T5 range, the controller suspends charging and waits until the battery temperature is within the T1 to T5 range.

At cool temperature (T1-T2), the charge current is reduced to 20% of programmed fast charge current. At warm temperature (T3-T5), the charge voltage is reduced to 4.1 V.

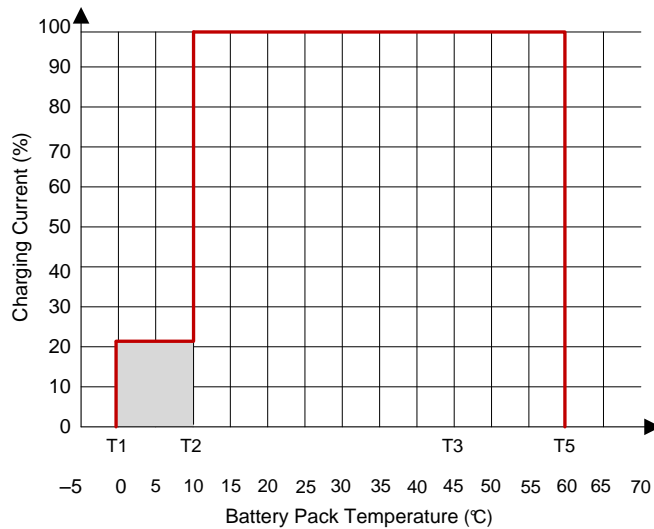

Figure 11. JEITA Profile: Charging Current

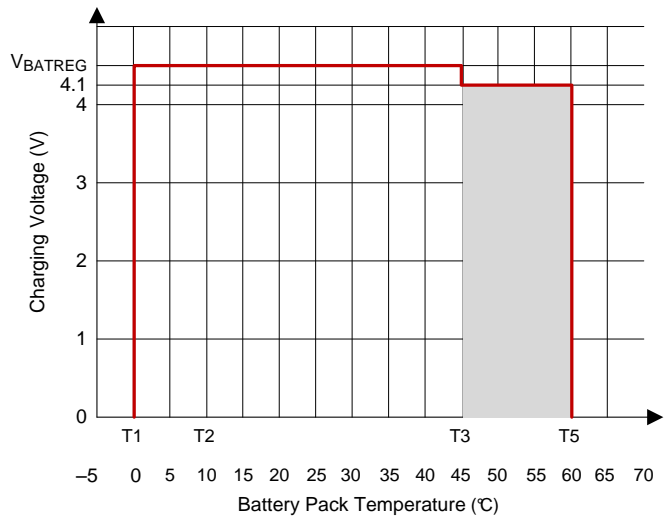

Figure 12. JEITA Profile: Charging Voltage

Equation 1 through Equation 2 describe updates to the resistor bias network.

$$RT2 = \frac{V_{REGN} \times RTH_{COLD} \times RTH_{HOT} \times \left(\frac{1}{VT1} - \frac{1}{VT5} \right)}{RTH_{HOT} \times \left(\frac{V_{REGN}}{VT5} - 1 \right) - RTH_{COLD} \times \left(\frac{V_{REGN}}{VT1} - 1 \right)} \quad (1)$$

$$RT1 = \frac{\left(\left(\frac{V_{REGN}}{VT1} \right) - 1 \right)}{\left(\frac{1}{RT2} \right) + \left(\frac{1}{RTH_{COLD}} \right)} \quad (2)$$

Select 0°C to 60°C range for Li-ion or Li-polymer battery:

- $RTH_{COLD} = 27.28 \text{ K}\Omega$
- $RTH_{HOT} = 3.02 \text{ K}\Omega$
- $RT1 = 5.23 \text{ K}\Omega$
- $RT2 = 30.9 \text{ K}\Omega$

8.3.6.5 Boost Mode Thermistor Monitor during Battery Discharge Mode

For battery protection during boost mode, the device monitors the battery temperature to be within the to thresholds. When temperature is outside of the temperature thresholds, the boost mode is suspended.

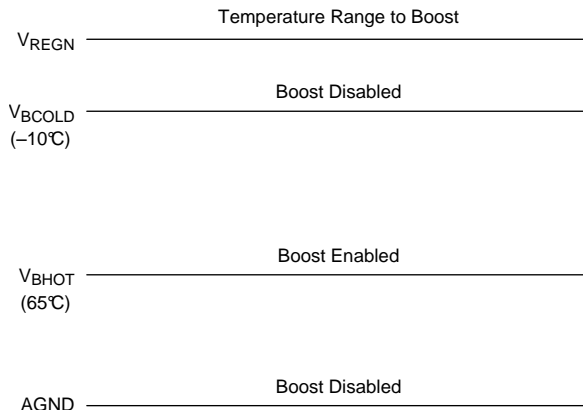

Figure 13. TS Pin Thermistor Sense Threshold in Boost Mode

8.3.6.6 Charging Safety Timer

The device has built-in safety timer to prevent extended charging cycle due to abnormal battery conditions. The safety timer is 2 hours when the battery is below $V_{BATLOWV}$ threshold and 10 hours when the battery is higher than $V_{BATLOWV}$ threshold.

During input voltage, current, JEITA cool or thermal regulation, the safety timer counts at half clock rate as the actual charge current is likely to be below the register setting. For example, if the charger is in input current regulation throughout the whole charging cycle, the safety timer will expire in 20 hours.

During the fault, timer is suspended. Once the fault goes away, fault resumes. If user stops the current charging cycle, and start again, timer gets reset.

8.3.6.7 Narrow VDC Architecture

The device deploys Narrow VDC architecture (NVDC) with BATFET separating system from battery. The minimum system voltage is set by SYS_Min bits. Even with a fully depleted battery, the system is regulated above the minimum system voltage.

When the battery is below minimum system voltage setting, the BATFET operates in linear mode (LDO mode), and the system is typically 180 mV above the minimum system voltage setting. As the battery voltage rises above the minimum system voltage, BATFET is fully on and the voltage difference between the system and battery is the VDS of BATFET.

When the battery charging is disabled and above minimum system voltage setting or charging is terminated, the system is always regulated at typically 50mV above battery voltage..

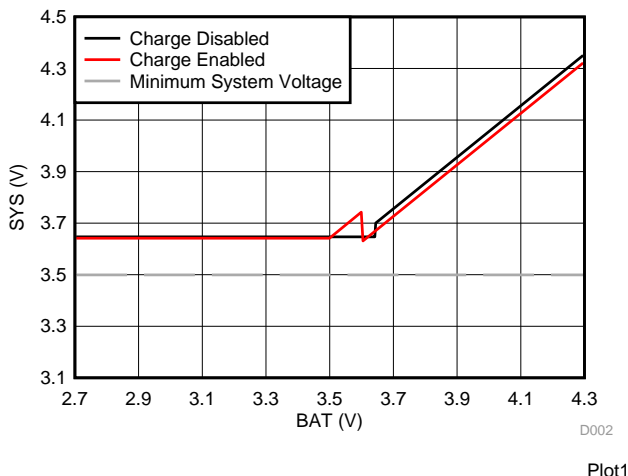

Figure 14. System Voltage vs Battery Voltage

8.3.6.8 Dynamic Power management

To meet maximum current limit in USB spec and avoid over loading the adapter, the device features Dynamic Power management (DPM), which continuously monitors the input current and input voltage. When input source is over-loaded, either the current exceeds the input current limit (IIDPM) or the voltage falls below the input voltage limit (VINDPM). The device then reduces the charge current until the input current falls below the input current limit and the input voltage rises above the input voltage limit.

When the charge current is reduced to zero, but the input source is still overloaded, the system voltage starts to drop. Once the system voltage falls below the battery voltage, the device automatically enters the supplement mode where the BATFET turns on and battery starts discharging so that the system is supported from both the input source and battery.

Figure 15 shows the DPM response with 9-V/1.2-A adapter, 3.2-V battery, 2.8-A charge current and 3.5-V minimum system voltage setting.

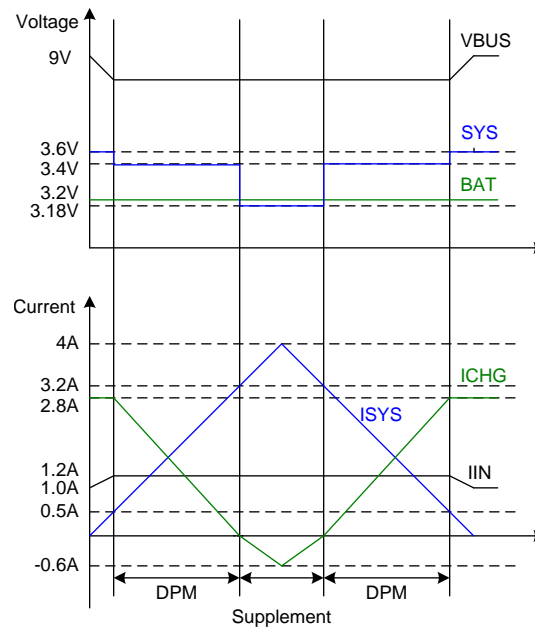

Figure 15. DPM Response

8.3.6.9 Supplement Mode

When the system voltage falls 180 mV ($V_{BAT} > V_{SYSMin}$) or 45 mV ($V_{BAT} < V_{SYSMin}$) below the battery voltage, the BATFET turns on and the BATFET gate is regulated the gate drive of BATFET so that the minimum BATFET VDS stays at 30 mV when the current is low. This prevents oscillation from entering and exiting the supplement mode.

As the discharge current increases, the BATFET gate is regulated with a higher voltage to reduce $R_{DS(on)}$ until the BATFET is in full conduction. At this point onwards, the BATFET VDS linearly increases with discharge current. Figure 16 shows the V-I curve of the BATFET gate regulation operation. BATFET turns off to exit supplement mode when the battery is below battery depletion threshold.

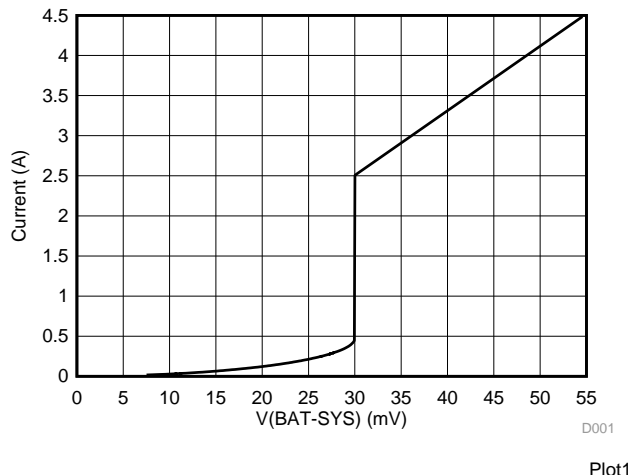

Figure 16. BAFET V-I Curve

8.3.7 Status Outputs ($\overline{\text{PG}}$, STAT)

8.3.7.1 Power Good indicator ($\overline{\text{PG}}$ Pin)

The $\overline{\text{PG}}$ pin goes LOW to indicate a good input source when:

- VBUS above $V_{\text{VBUS_UVLO}}$
- VBUS above battery (not in sleep)
- VBUS below $V_{\text{VAC_OV}}$ threshold
- VBUS above V_{VBUSMin} (typical 3.8 V) when I_{BADSRC} (typical 30 mA) current is applied (not a poor source)
- Completed *input Source Type Detection*

8.3.7.2 Charging Status indicator (STAT)

The device indicates charging state on the open drain STAT pin. The STAT pin can drive LED.

Table 4. STAT Pin State

CHARGING STATE	STAT INDICATOR
Charging in progress (including recharge)	LOW
Charging complete	HIGH
Sleep mode, charge disable	HIGH
Charge suspend (input overvoltage, TS fault, timer fault or system overvoltage) Boost Mode suspend (due to TS fault)	Blinking at 1 Hz

8.3.8 Protections

8.3.8.1 Input Current Limit

The device's ILIM pin is to program maximum input current when D+/D- detection identifies an unknown adaptor plugged in. The maximum input current is set by a resistor from ILIM pin to ground as:

$$I_{\text{INMAX}} = \frac{K_{\text{ILIM}}}{R_{\text{ILIM}}} \quad (3)$$

8.3.8.2 Voltage and Current Monitoring in Converter Operation

The device closely monitors the input and system voltage, as well as internal FET currents for safe buck and boost mode operation.

8.3.8.2.1 Voltage and Current Monitoring in Buck Mode

8.3.8.2.1.1 Input Overvoltage (ACOV)

If VAC exceeds V_{VAC_OV} , HSFET stops switching immediately.

8.3.8.2.1.2 System Overvoltage Protection (SYSOVP)

The charger device clamps the system voltage during load transient so that the components connect to system would not be damaged due to high voltage. SYSOVP threshold is 350 mV above minimum system regulation voltage when the system is regulate at V_{SYSMIN} . Upon SYSOVP, converter stops switching immediately to clamp the overshoot. The charger provides 30 mA discharge current to bring down the system voltage.

8.3.8.3 Voltage and Current Monitoring in Boost Mode

The device closely monitors the VBUS voltage, as well as RBFET and LSFET current to ensure safe boost mode operation.

8.3.8.3.1 VBUS Soft Start

When the boost function is enabled, the device soft-starts boost mode to avoid inrush current.

8.3.8.3.2 VBUS Output Protection

The device monitors boost output voltage and other conditions to provide output short circuit and overvoltage protection. The Boost build in accurate constant current regulation to allow OTG to adaptive to various types of load. If short circuit is detected on VBUS, the Boost turns off and retry 7 times. If retries are not successful, OTG is disabled.

8.3.8.3.3 Boost Mode Overvoltage Protection

When the VBUS voltage rises above regulation target and exceeds $VOTG_OVP$, the device stop switching.

8.3.8.4 Thermal Regulation and Thermal Shutdown

8.3.8.4.1 Thermal Protection in Buck Mode

The bq25606 monitors the internal junction temperature T_J to avoid overheat the chip and limits the IC surface temperature in buck mode. When the internal junction temperature exceeds thermal regulation limit (110°C), the device lowers down the charge current. During thermal regulation, the actual charging current is usually below the programmed battery charging current. Therefore, termination is disabled, the safety timer runs at half the clock rate.

8.3.8.4.2 Thermal Protection in Boost Mode

The device monitors the internal junction temperature to provide thermal shutdown during boost mode. When IC junction temperature exceeds T_{SHUT} (160°C), the boost mode is disabled and BATFET is turned off. When IC junction temperature is below $T_{SHUT}(160°C) - T_{SHUT_HYS}$ (30°C), the BATFET is enabled automatically to allow system to restore .

8.3.8.5 Battery Protection

8.3.8.5.1 Battery overvoltage Protection (BATOVP)

The battery overvoltage limit is clamped at 4% above the battery regulation voltage. When battery over voltage occurs, the charger device immediately disables charging.

8.3.8.5.2 Battery Over-Discharge Protection

When battery is discharged below $V_{BAT_DPL_FALL}$, the BATFET is turned off to protect battery from over discharge. To recover from over-discharge latch-off, an input source plug-in is required at VBUS. The battery is charged with I_{SHORT} (typically 100 mA) current when the $VBAT < V_{SHORT}$, or precharge current as set by 5% of ICHG when the battery voltage is between V_{SHORTZ} and V_{BAT_LOWV} .

8.3.8.5.3 System Over-Current Protection

When the system is shorted or significantly overloaded ($IBAT > IBATOP$) and the current exceeds BATFET overcurrent limit, the BATFET latches off. The BATFET latch can be reset with VBUS plug-in.

9 Application and Implementation

NOTE

information in the following applications sections is not part of the TI component specification, and TI does not warrant its accuracy or completeness. TI's customers are responsible for determining suitability of components for their purposes. Customers should validate and test their design implementation to confirm system functionality.

9.1 Application information

A typical application consists of the device configured as a stand-alone power path management device and a single cell battery charger for Li-Ion and Li-polymer batteries used in a wide range of smart phones and other portable devices. It integrates an input reverse-block FET (RBFET, Q1), high-side switching FET (HSFET, Q2), low-side switching FET (LSFET, Q3), and battery FET (BATFET Q4) between the system and battery. The device also integrates a bootstrap diode for the high-side gate drive.

9.2 Typical Application Diagram

Figure 17. Power Path Management Application

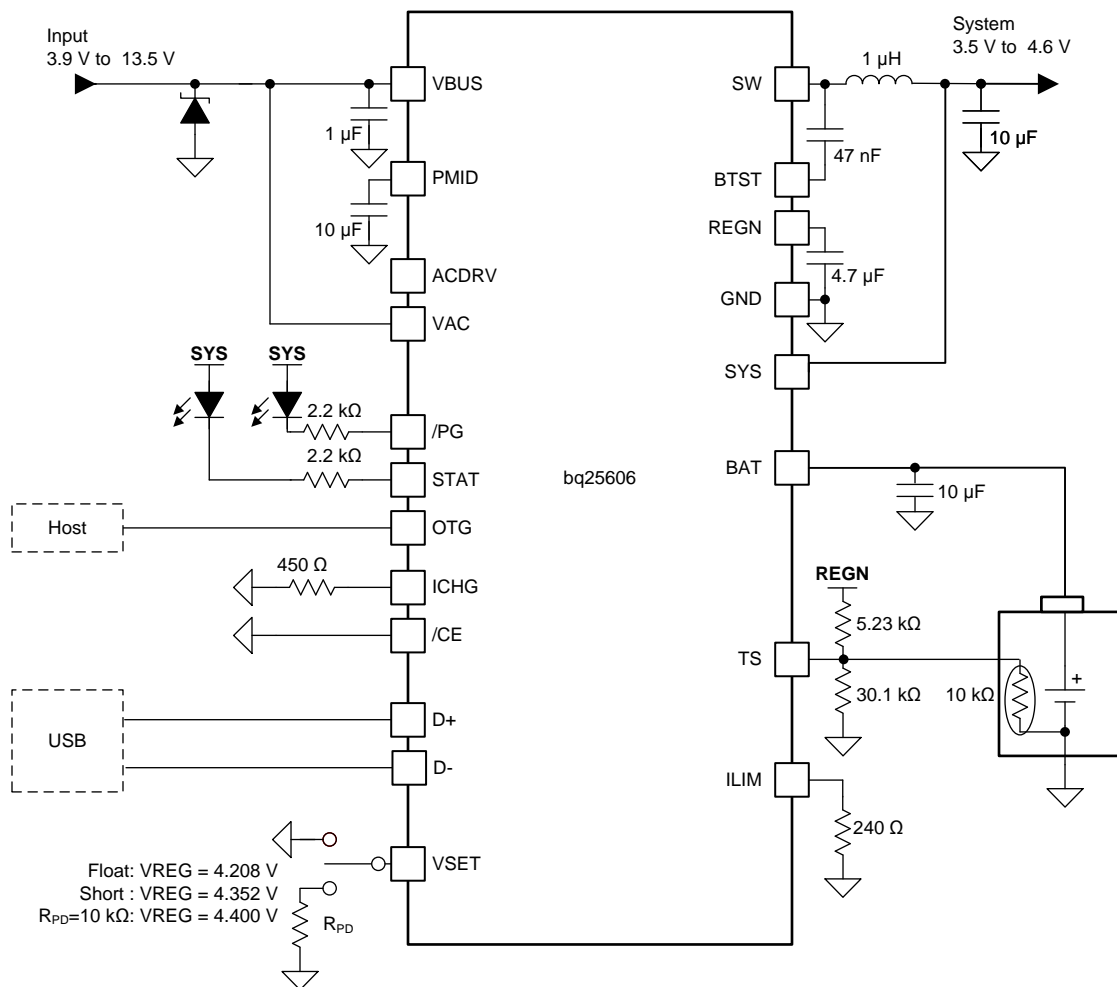

Figure 18. bq25606 Application Diagram

9.2.1 Design Requirements

9.2.2 Detailed Design Procedure

9.2.2.1 Inductor Selection

The 1.5-MHz switching frequency allows the use of small inductor and capacitor values to maintain an inductor saturation current higher than the charging current (I_{CHG}) plus half the ripple current (I_{RIPPLE}):

$$I_{SAT} \geq I_{CHG} + (1/2) I_{RIPPLE} \quad (4)$$

The inductor ripple current depends on the input voltage (V_{VBUS}), the duty cycle ($D = V_{BAT}/V_{VBUS}$), the switching frequency (f_s) and the inductance (L).

$$I_{RIPPLE} = \frac{V_{IN} \times D \times (1 - D)}{f_s \times L} \quad (5)$$

The maximum inductor ripple current occurs when the duty cycle (D) is 0.5 or approximately 0.5. Usually inductor ripple is designed in the range between 20% and 40% maximum charging current as a trade-off between inductor size and efficiency for a practical design.

Typical Application Diagram (continued)

9.2.2.2 Input Capacitor

Design input capacitance to provide enough ripple current rating to absorb input switching ripple current. The worst case RMS ripple current is half of the charging current when duty cycle is 0.5. If the converter does not operate at 50% duty cycle, then the worst case capacitor RMS current I_{CIN} occurs where the duty cycle is closest to 50% and can be estimated using [Equation 6](#).

$$I_{CIN} = I_{CHG} \times \sqrt{D \times (1 - D)} \quad (6)$$

Low ESR ceramic capacitor such as X7R or X5R is preferred for input decoupling capacitor and should be placed to the drain of the high-side MOSFET and source of the low-side MOSFET as close as possible. Voltage rating of the capacitor must be higher than normal input voltage level. A rating of 25-V or higher capacitor is preferred for 15 V input voltage. Capacitance of 22- μ F is suggested for typical of 3A charging current.

9.2.2.3 Output Capacitor

Ensure that the output capacitance has enough ripple current rating to absorb the output switching ripple current. [Equation 7](#) shows the output capacitor RMS current I_{COUT} calculation.

$$I_{COUT} = \frac{I_{RIPPLE}}{2 \times \sqrt{3}} \approx 0.29 \times I_{RIPPLE} \quad (7)$$

The output capacitor voltage ripple can be calculated as follows:

$$\Delta V_O = \frac{V_{OUT}}{8LCfs^2} \left(1 - \frac{V_{OUT}}{V_{IN}} \right) \quad (8)$$

At certain input and output voltage and switching frequency, the voltage ripple can be reduced by increasing the output filter LC.

The charger device has internal loop compensation optimized for >20 μ F ceramic output capacitance. The preferred ceramic capacitor is 10V rating, X7R or X5R.

9.3 Application Curves

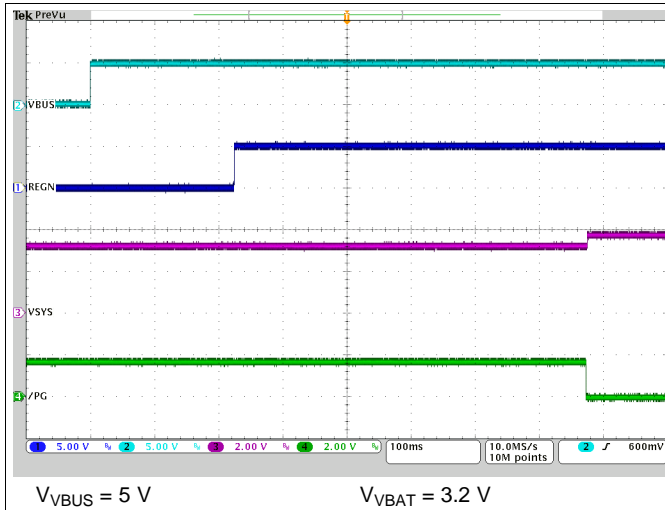

Figure 19. Power-Up with Charge Disabled

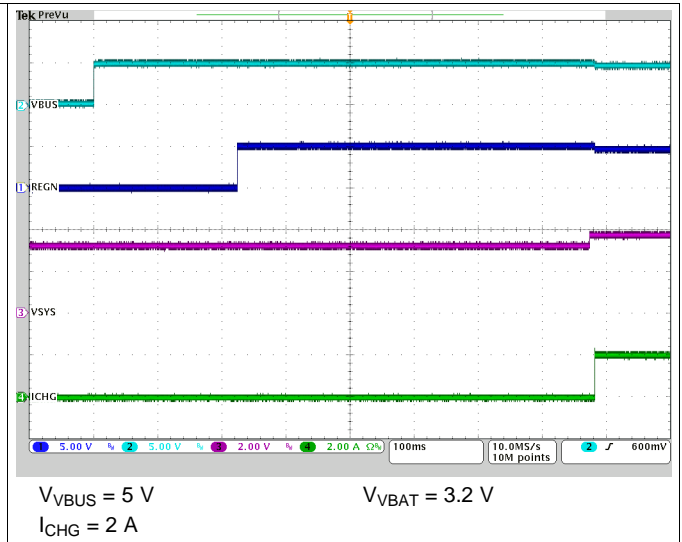

Figure 20. Power-Up with Charge Enabled

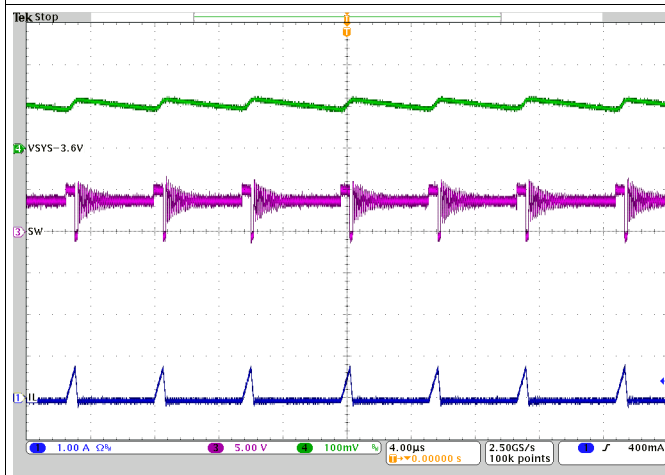

Figure 21. PFM Switching in Buck Mode

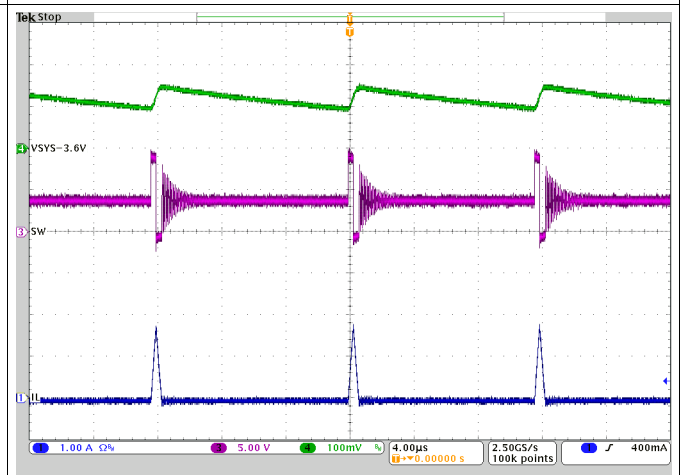
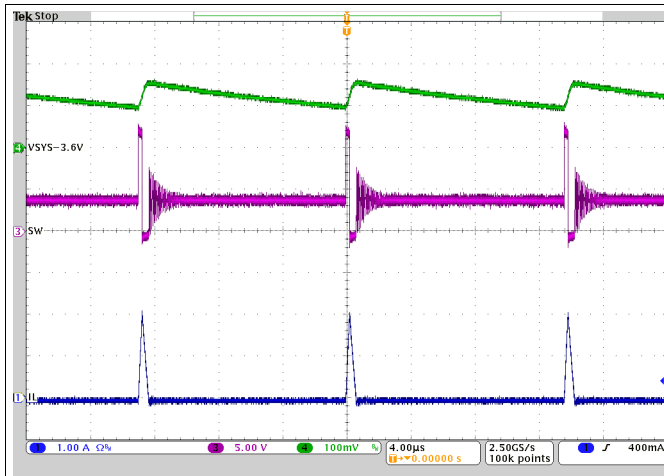

Figure 22. PFM Switching in Buck Mode

Application Curves (continued)



$V_{VBUS} = 12\text{ V}$
 $I_{SYS} = 50\text{ mA}$
 Charge Disabled

Figure 23. PFM Switching in Buck Mode

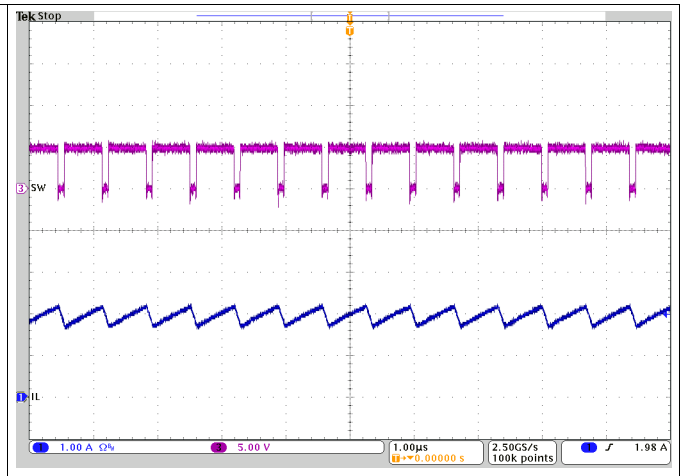

$V_{VBUS} = 5\text{ V}$
 $I_{CHG} = 2\text{ A}$
 $V_{VBAT} = 3.8\text{ V}$

Figure 24. PWM Switching in Buck Mode

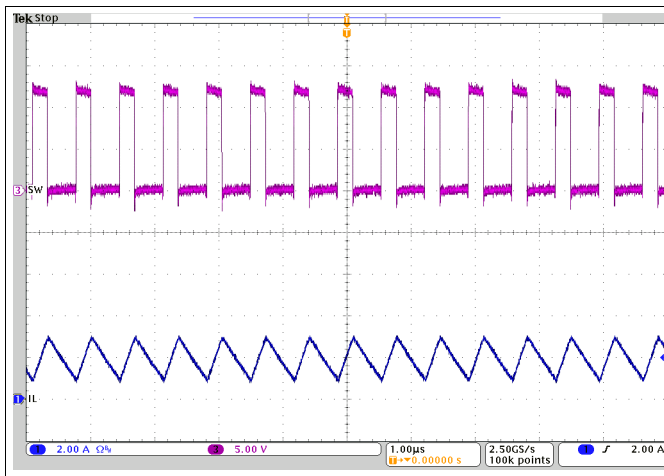

$V_{VBUS} = 12\text{ V}$
 $I_{CHG} = 2\text{ A}$
 $V_{VBAT} = 3.8\text{ V}$

Figure 25. PWM Switching in Buck mode

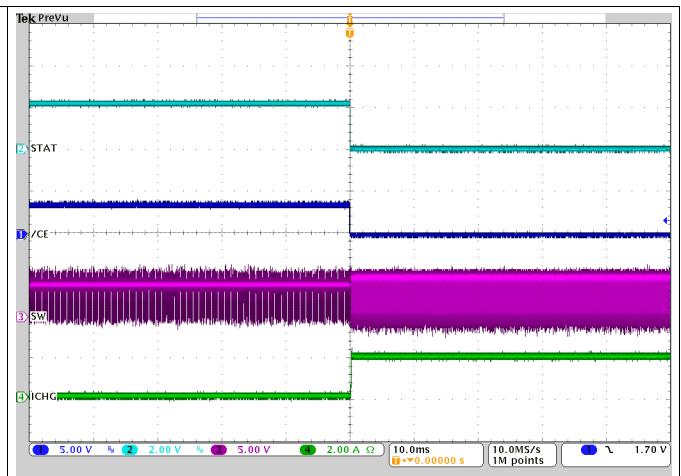

$V_{VBUS} = 5\text{ V}$
 $I_{CHG} = 2\text{ A}$
 $V_{VBAT} = 3.2\text{ V}$

Figure 26. Charge Enable

Application Curves (continued)



$V_{VBUS} = 5\text{ V}$
 $V_{VBAT} = 3.2\text{ V}$
 $I_{CHG} = 2\text{ A}$

Figure 27. Charge Disable

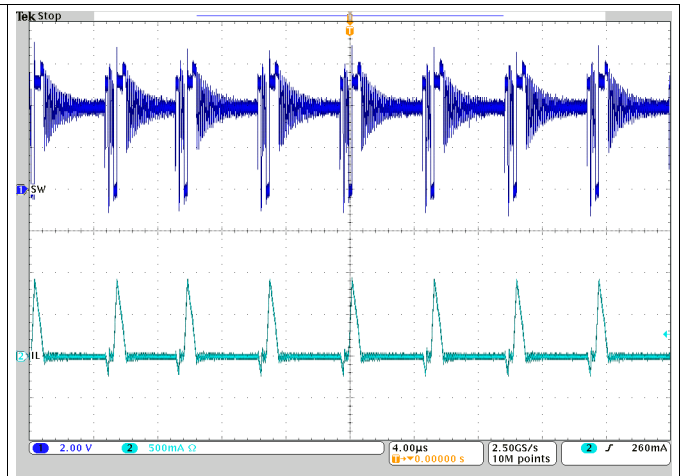

$V_{VBAT} = 4\text{ V}$
 $I_{LOAD} = 50\text{ mA}$

PFM Enabled

Figure 28. OTG Switching

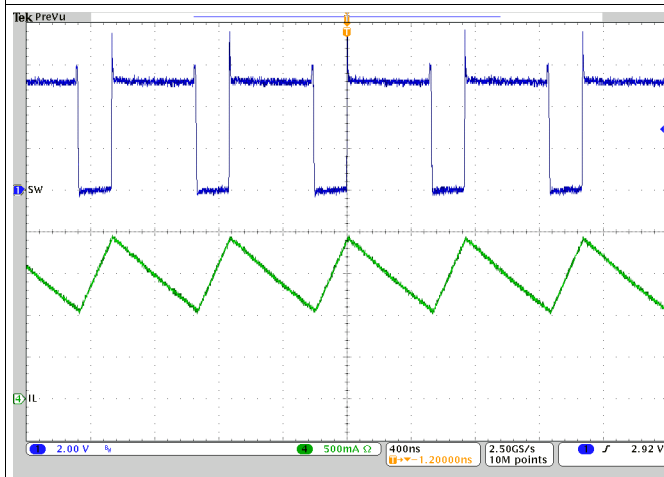

$V_{VBAT} = 4\text{ V}$
 $I_{LOAD} = 1\text{ A}$

PFM Enabled

Figure 29. OTG Switching

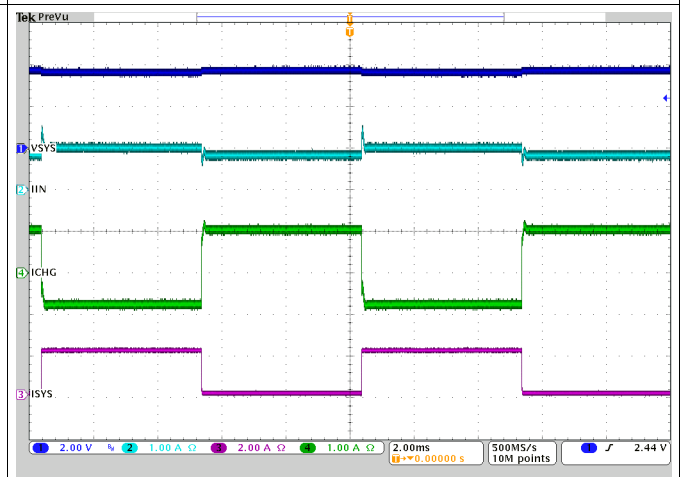

$V_{VBUS} = 5\text{ V}$
 I_{SYS} from 0 A to 2 A
 $V_{BAT} = 3.7\text{ V}$
 $I_{INDPM} = 1\text{ A}$
 $I_{CHG} = 1\text{ A}$

Figure 30. System Load Transient

Application Curves (continued)

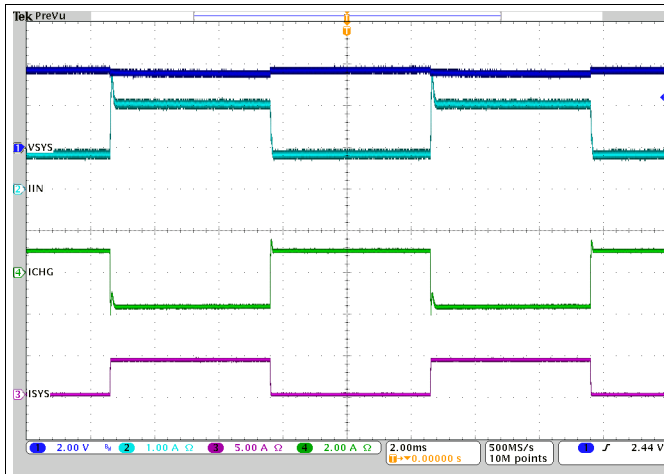

$V_{VBUS} = 5\text{ V}$
 $I_{INDPM} = 2\text{ A}$
 I_{SYS} from 0 A to 4 A
 $I_{CHG} = 1\text{ A}$
 $V_{BAT} = 3.7\text{ V}$

Figure 31. System Load Transient

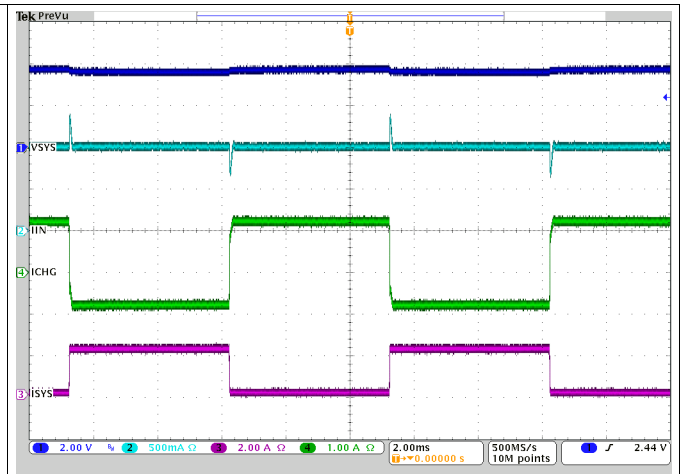

$V_{VBUS} = 5\text{ V}$
 $I_{INDPM} = 1\text{ A}$
 I_{SYS} from 0 A to 2 A
 $I_{CHG} = 2\text{ A}$
 $V_{BAT} = 3.7\text{ V}$

Figure 32. System Load Transient

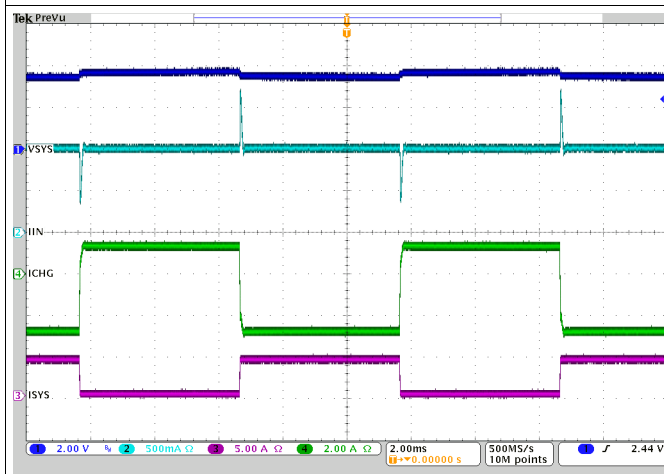

$V_{VBUS} = 5\text{ V}$
 $I_{INDPM} = 1\text{ A}$
 I_{SYS} from 0 A to 4 A
 $I_{CHG} = 2\text{ A}$
 $V_{BAT} = 3.7\text{ V}$

Figure 33. System Load Transient

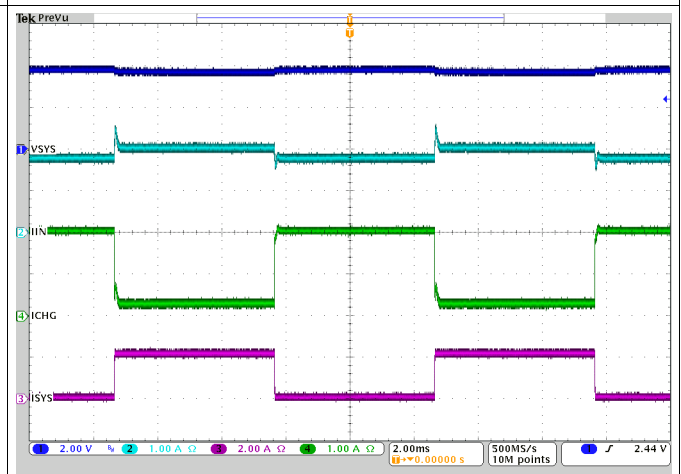

$V_{VBUS} = 5\text{ V}$
 $I_{INDPM} = 2\text{ A}$
 I_{SYS} from 0 A to 2 A
 $I_{CHG} = 2\text{ A}$
 $V_{BAT} = 3.7\text{ V}$

Figure 34. System Load Transient

Application Curves (continued)

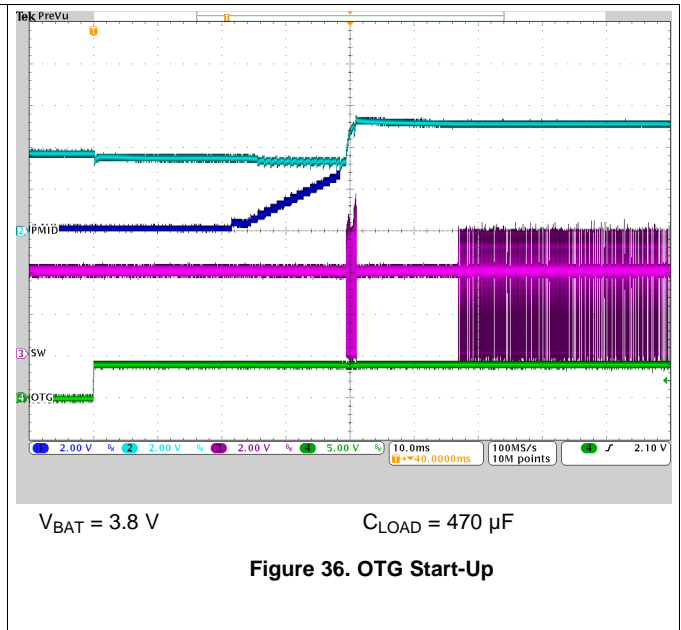
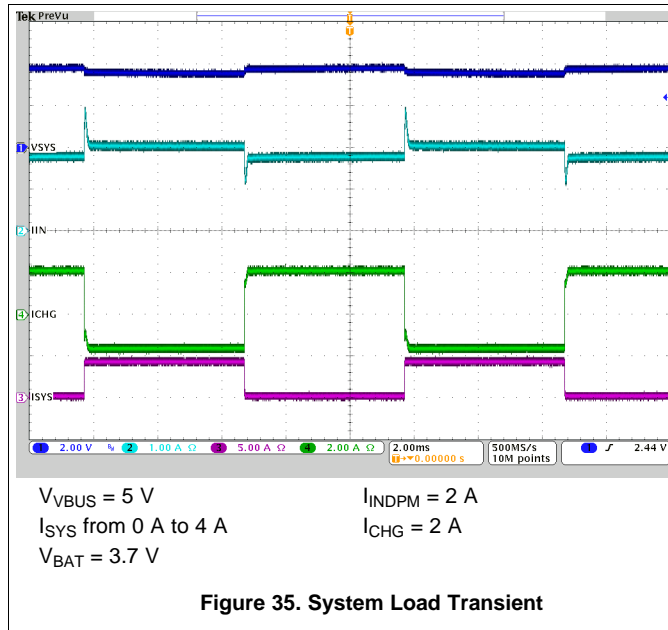

10 Power Supply Recommendations

in order to provide an output voltage on SYS, the bq25606 device requires a power supply between 3.9 V and 14.2 V input with at least 100-mA current rating connected to VBUS and a single-cell Li-Ion battery with voltage $> V_{BATUVLO}$ connected to BAT. The source current rating needs to be at least 3 A in order for the buck converter of the charger to provide maximum output power to SYS.

11 Layout

11.1 Layout Guidelines

The switching node rise and fall times should be minimized for minimum switching loss. Proper layout of the components to minimize high frequency current path loop (see [Figure 37](#)) is important to prevent electrical and magnetic field radiation and high frequency resonant problems. Follow this specific order carefully to achieve the proper layout.

1. Place input capacitor as close as possible to PMID pin and GND pin connections and use shortest copper trace connection or GND plane.
2. Place inductor input pin to SW pin as close as possible. Minimize the copper area of this trace to lower electrical and magnetic field radiation but make the trace wide enough to carry the charging current. Do not use multiple layers in parallel for this connection. Minimize parasitic capacitance from this area to any other trace or plane.
3. Put output capacitor near to the inductor and the device. Ground connections need to be tied to the IC ground with a short copper trace connection or GND plane.
4. Route analog ground separately from power ground. Connect analog ground and connect power ground separately. Connect analog ground and power ground together using thermal pad as the single ground connection point. Or using a 0- Ω resistor to tie analog ground to power ground.
5. Use single ground connection to tie charger power ground to charger analog ground. Just beneath the device. Use ground copper pour but avoid power pins to reduce inductive and capacitive noise coupling.
6. Place decoupling capacitors next to the IC pins and make trace connection as short as possible.
7. It is critical that the exposed thermal pad on the backside of the device package be soldered to the PCB ground. Ensure that there are sufficient thermal vias directly under the IC, connecting to the ground plane on the other layers.
8. Ensure that the number and sizes of vias allow enough copper for a given current path.

See the EVM user's guide [SLUUBL3](#) for the recommended component placement with trace and via locations. For the VQFN information, refer to [SCBA017](#) and [SLUA271](#).

11.2 Layout Example

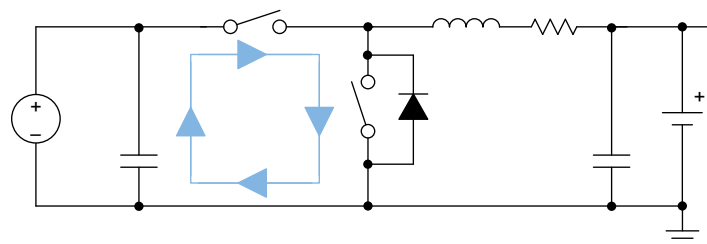

Figure 37. High Frequency Current Path

Layout Example (continued)

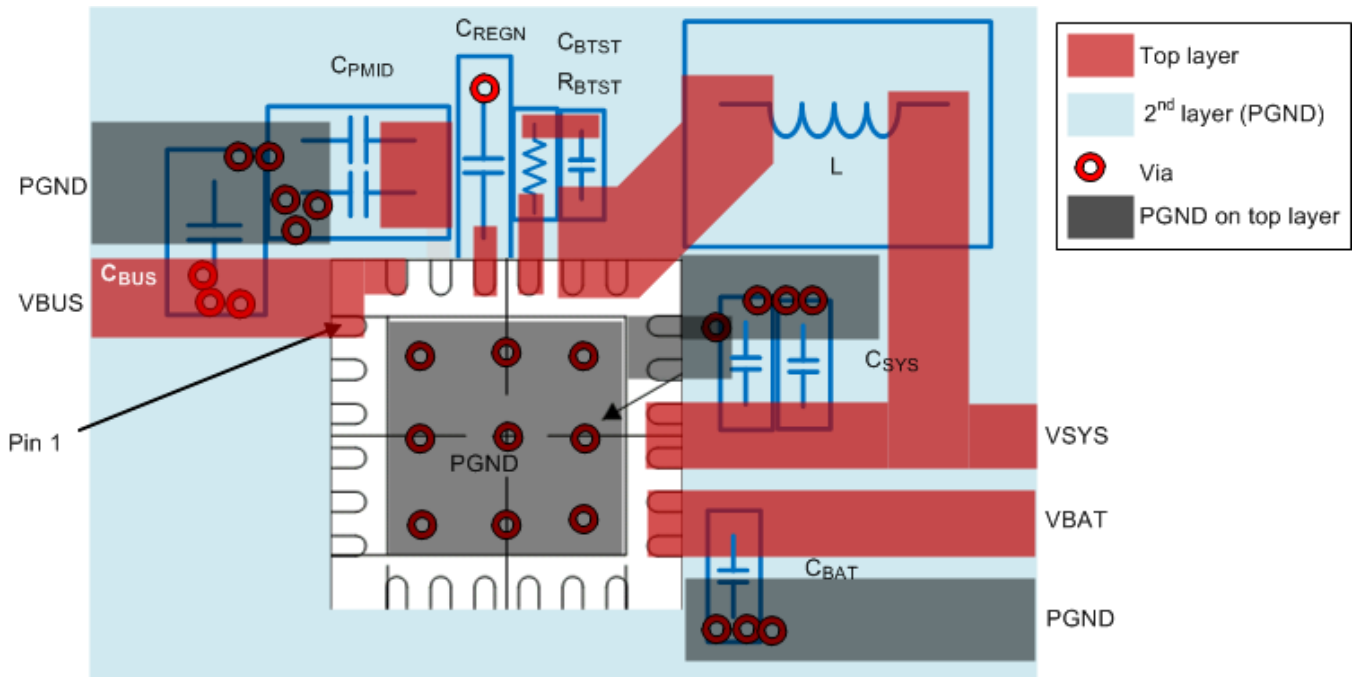

Figure 38. Layout Example

12 Device and Documentation Support

12.1 Documentation Support

12.1.1 Related Links

The table below lists quick access links. Categories include technical documents, support and community resources, tools and software, and quick access to sample or buy.

12.2 Community Resources

The following links connect to TI community resources. Linked contents are provided "AS IS" by the respective contributors. They do not constitute TI specifications and do not necessarily reflect TI's views; see TI's [Terms of Use](#).

TI E2E™ Online Community *TI's Engineer-to-Engineer (E2E) Community*. Created to foster collaboration among engineers. At e2e.ti.com, you can ask questions, share knowledge, explore ideas and help solve problems with fellow engineers.

Design Support *TI's Design Support* Quickly find helpful E2E forums along with design support tools and contact information for technical support.

12.3 Trademarks

E2E is a trademark of Texas Instruments.

WEBENCH is a registered trademark of Texas Instruments.

12.4 Electrostatic Discharge Caution



These devices have limited built-in ESD protection. The leads should be shorted together or the device placed in conductive foam during storage or handling to prevent electrostatic damage to the MOS gates.

12.5 Glossary

[SLYZ022](#) — *TI Glossary*.

This glossary lists and explains terms, acronyms, and definitions.

13 Mechanical, Packaging, and Orderable Information

The following pages include mechanical, packaging, and orderable information. This information is the most current data available for the designated devices. This data is subject to change without notice and revision of this document. For browser-based versions of this data sheet, refer to the left-hand navigation.

PACKAGING INFORMATION

Orderable Device	Status (1)	Package Type	Package Drawing	Pins	Package Qty	Eco Plan (2)	Lead/Ball Finish (6)	MSL Peak Temp (3)	Op Temp (°C)	Device Marking (4/5)	Samples
BQ25606RGER	ACTIVE	VQFN	RGE	24	3000	Green (RoHS & no Sb/Br)	CU NIPDAU	Level-2-260C-1 YEAR	-40 to 85	BQ25606	Samples
BQ25606RGET	ACTIVE	VQFN	RGE	24	250	Green (RoHS & no Sb/Br)	CU NIPDAU	Level-2-260C-1 YEAR	-40 to 85	BQ25606	Samples

(1) The marketing status values are defined as follows:

ACTIVE: Product device recommended for new designs.

LIFEBUY: TI has announced that the device will be discontinued, and a lifetime-buy period is in effect.

NRND: Not recommended for new designs. Device is in production to support existing customers, but TI does not recommend using this part in a new design.

PREVIEW: Device has been announced but is not in production. Samples may or may not be available.

OBsolete: TI has discontinued the production of the device.

(2) **RoHS:** TI defines "RoHS" to mean semiconductor products that are compliant with the current EU RoHS requirements for all 10 RoHS substances, including the requirement that RoHS substance do not exceed 0.1% by weight in homogeneous materials. Where designed to be soldered at high temperatures, "RoHS" products are suitable for use in specified lead-free processes. TI may reference these types of products as "Pb-Free".

RoHS Exempt: TI defines "RoHS Exempt" to mean products that contain lead but are compliant with EU RoHS pursuant to a specific EU RoHS exemption.

Green: TI defines "Green" to mean the content of Chlorine (Cl) and Bromine (Br) based flame retardants meet JS709B low halogen requirements of <=1000ppm threshold. Antimony trioxide based flame retardants must also meet the <=1000ppm threshold requirement.

(3) MSL, Peak Temp. - The Moisture Sensitivity Level rating according to the JEDEC industry standard classifications, and peak solder temperature.

(4) There may be additional marking, which relates to the logo, the lot trace code information, or the environmental category on the device.

(5) Multiple Device Markings will be inside parentheses. Only one Device Marking contained in parentheses and separated by a "~" will appear on a device. If a line is indented then it is a continuation of the previous line and the two combined represent the entire Device Marking for that device.

(6) Lead/Ball Finish - Orderable Devices may have multiple material finish options. Finish options are separated by a vertical ruled line. Lead/Ball Finish values may wrap to two lines if the finish value exceeds the maximum column width.

Important Information and Disclaimer:The information provided on this page represents TI's knowledge and belief as of the date that it is provided. TI bases its knowledge and belief on information provided by third parties, and makes no representation or warranty as to the accuracy of such information. Efforts are underway to better integrate information from third parties. TI has taken and continues to take reasonable steps to provide representative and accurate information but may not have conducted destructive testing or chemical analysis on incoming materials and chemicals. TI and TI suppliers consider certain information to be proprietary, and thus CAS numbers and other limited information may not be available for release.

In no event shall TI's liability arising out of such information exceed the total purchase price of the TI part(s) at issue in this document sold by TI to Customer on an annual basis.

TAPE AND REEL INFORMATION

QUADRANT ASSIGNMENTS FOR PIN 1 ORIENTATION IN TAPE

*All dimensions are nominal

Device	Package Type	Package Drawing	Pins	SPQ	Reel Diameter (mm)	Reel Width W1 (mm)	A0 (mm)	B0 (mm)	K0 (mm)	P1 (mm)	W (mm)	Pin1 Quadrant
BQ25606RGER	VQFN	RGE	24	3000	330.0	12.4	4.25	4.25	1.15	8.0	12.0	Q2
BQ25606RGET	VQFN	RGE	24	250	180.0	12.4	4.25	4.25	1.15	8.0	12.0	Q2

TAPE AND REEL BOX DIMENSIONS

*All dimensions are nominal

Device	Package Type	Package Drawing	Pins	SPQ	Length (mm)	Width (mm)	Height (mm)
BQ25606RGER	VQFN	RGE	24	3000	367.0	367.0	35.0
BQ25606RGET	VQFN	RGE	24	250	210.0	185.0	35.0

RGE 24

GENERIC PACKAGE VIEW

VQFN - 1 mm max height

PLASTIC QUAD FLATPACK - NO LEAD



Images above are just a representation of the package family, actual package may vary.
Refer to the product data sheet for package details.

4204104/H

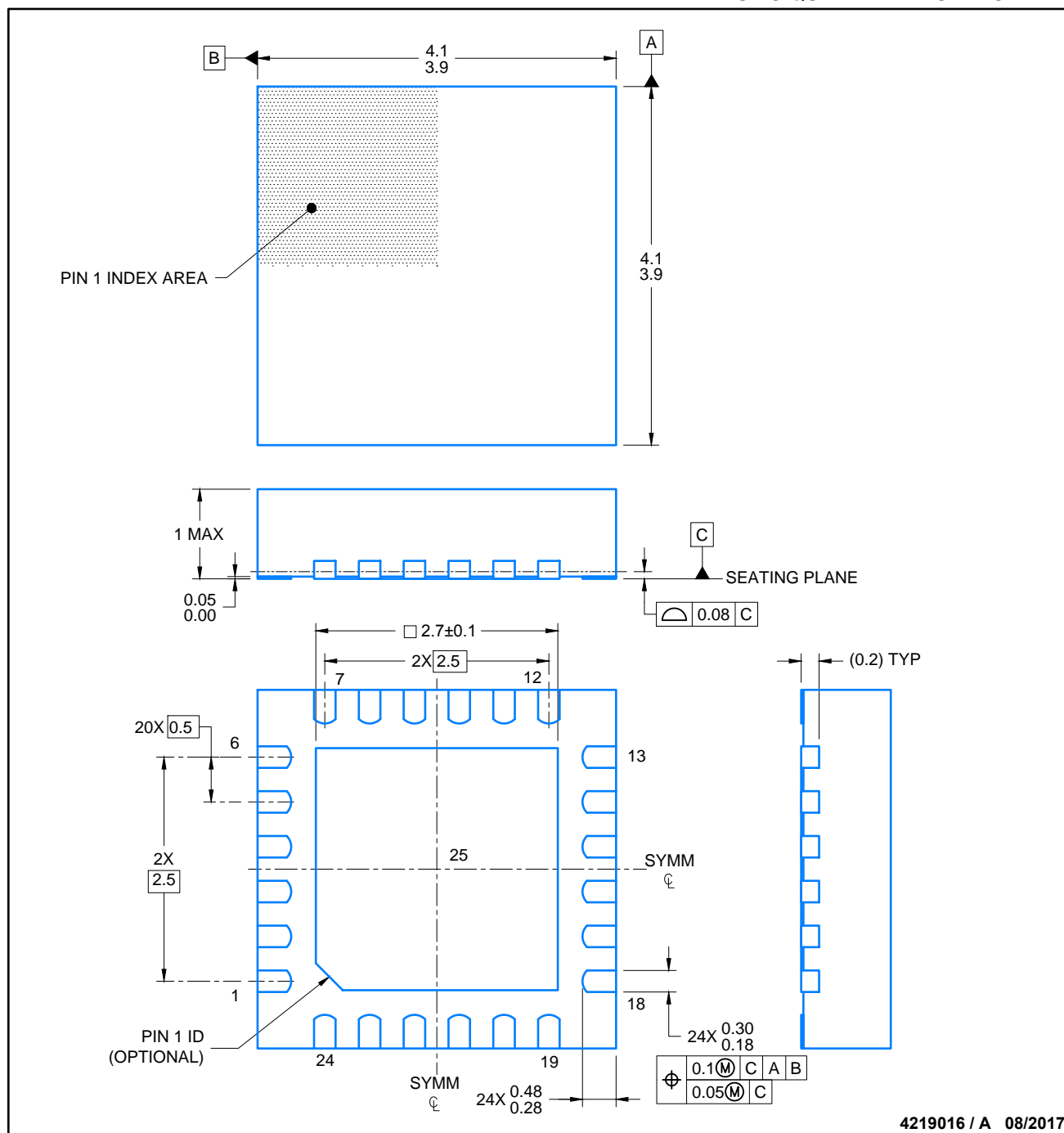

NOTES:

1. All linear dimensions are in millimeters. Any dimensions in parenthesis are for reference only. Dimensioning and tolerancing per ASME Y14.5M.
2. This drawing is subject to change without notice.
3. The package thermal pad must be soldered to the printed circuit board for thermal and mechanical performance.

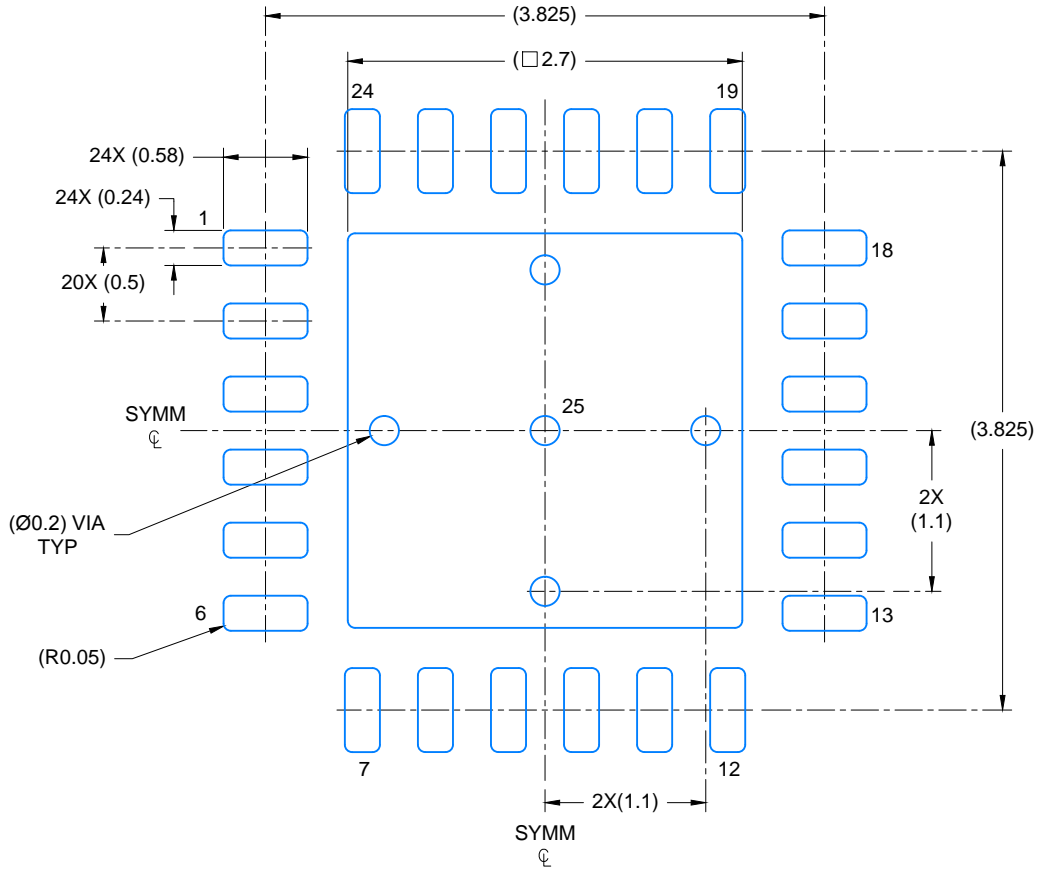

LAND PATTERN EXAMPLE
SCALE: 20X

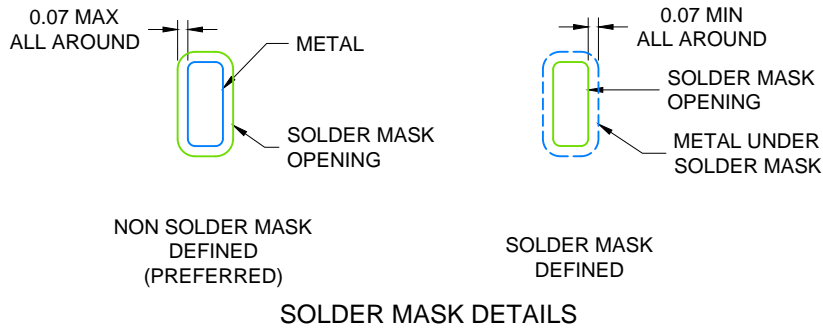

4219016 / A 08/2017

NOTES: (continued)

4. This package is designed to be soldered to a thermal pad on the board. For more information, see Texas Instruments literature number SLUA271 (www.ti.com/lit/slua271).
5. Solder mask tolerances between and around signal pads can vary based on board fabrication site.

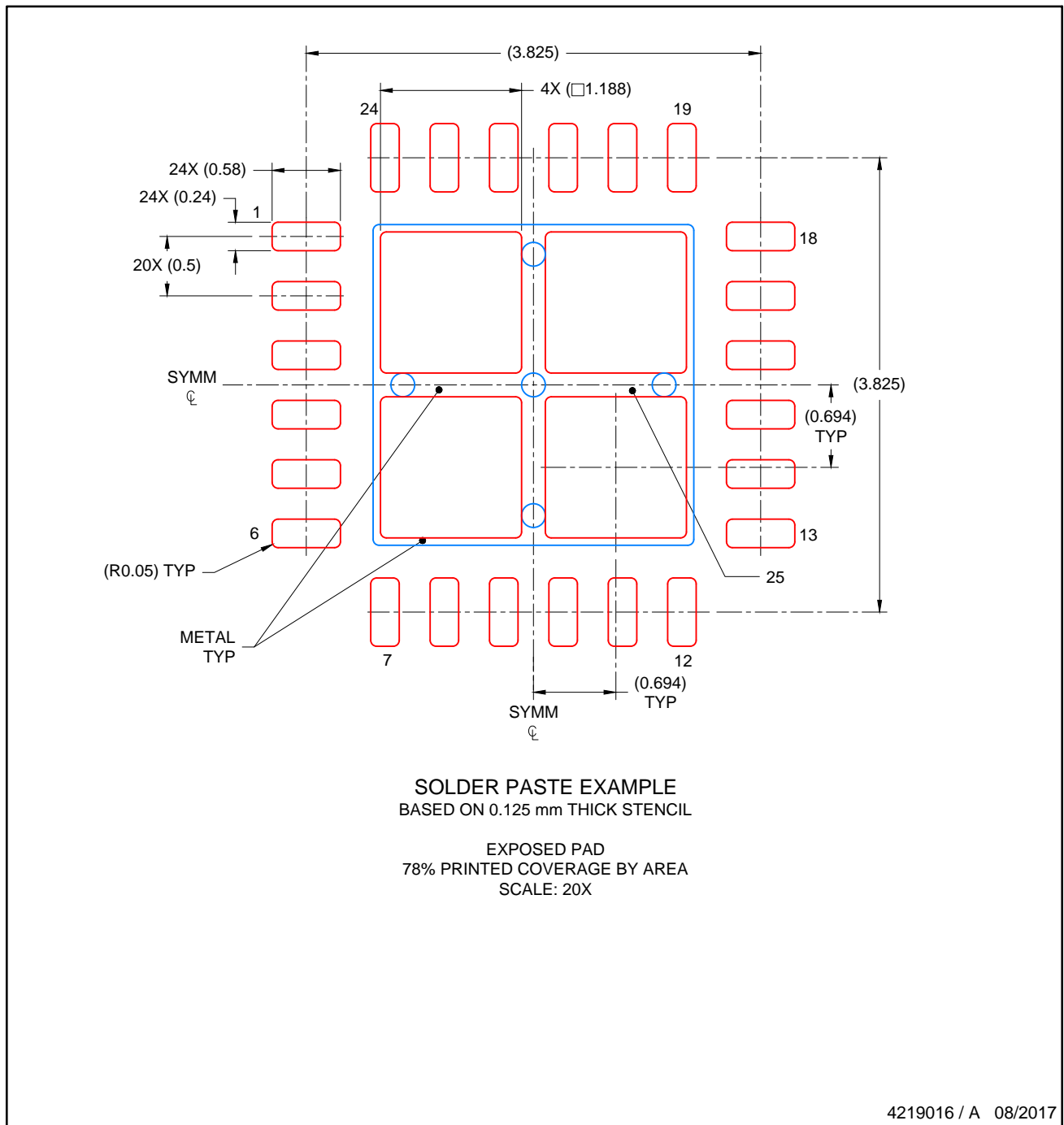

NOTES: (continued)

- 6. Laser cutting apertures with trapezoidal walls and rounded corners may offer better paste release. IPC-7525 may have alternate design recommendations..

IMPORTANT NOTICE AND DISCLAIMER

TI PROVIDES TECHNICAL AND RELIABILITY DATA (INCLUDING DATASHEETS), DESIGN RESOURCES (INCLUDING REFERENCE DESIGNS), APPLICATION OR OTHER DESIGN ADVICE, WEB TOOLS, SAFETY INFORMATION, AND OTHER RESOURCES "AS IS" AND WITH ALL FAULTS, AND DISCLAIMS ALL WARRANTIES, EXPRESS AND IMPLIED, INCLUDING WITHOUT LIMITATION ANY IMPLIED WARRANTIES OF MERCHANTABILITY, FITNESS FOR A PARTICULAR PURPOSE OR NON-INFRINGEMENT OF THIRD PARTY INTELLECTUAL PROPERTY RIGHTS.

These resources are intended for skilled developers designing with TI products. You are solely responsible for (1) selecting the appropriate TI products for your application, (2) designing, validating and testing your application, and (3) ensuring your application meets applicable standards, and any other safety, security, or other requirements. These resources are subject to change without notice. TI grants you permission to use these resources only for development of an application that uses the TI products described in the resource. Other reproduction and display of these resources is prohibited. No license is granted to any other TI intellectual property right or to any third party intellectual property right. TI disclaims responsibility for, and you will fully indemnify TI and its representatives against, any claims, damages, costs, losses, and liabilities arising out of your use of these resources.

TI's products are provided subject to TI's Terms of Sale (www.ti.com/legal/termsofsale.html) or other applicable terms available either on ti.com or provided in conjunction with such TI products. TI's provision of these resources does not expand or otherwise alter TI's applicable warranties or warranty disclaimers for TI products.

Mailing Address: Texas Instruments, Post Office Box 655303, Dallas, Texas 75265
Copyright © 2019, Texas Instruments Incorporated