

Four Output PCI-X and General Purpose Buffer

Features

- One input to four output buffer/driver
- General-purpose or PCI-X clock buffer
- Buffers all frequencies from DC to 140 MHz
- Output-to-output skew less than 100 ps
- Space-saving 8-pin TSSOP package
- 3.3 V operation
- 60 ps typical output-output skew

Functional Description

The CY2304NZ is a low-cost buffer designed to distribute high-speed clocks for PCI-X and other applications. The device operates at 3.3 V and outputs can run up to 140 MHz.

For a complete list of related documentation, click [here](#).

Function Table

Inputs		Outputs
BUF_IN	OE	Output [1:4]
L	L	L
H	L	L
L	H	L
H	H	H

Block Diagram

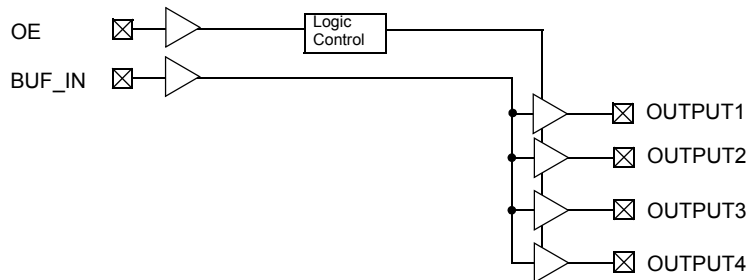

Pin Configuration

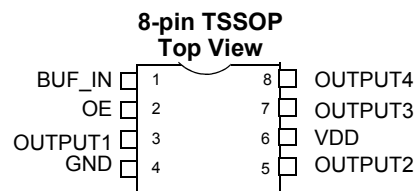

Pin Description

For CY2304NZ

Signal	Pin	Description
V _{DD}	6	3.3 V voltage supply
GND	4	Ground
BUF_IN	1	Input clock
OUTPUT [1:4]	3, 5, 7, 8	Outputs
OE	2	Input pin for output enable, active HIGH.

Maximum Ratings

Supply Voltage to Ground Potential -0.5 V to $V_{DD} + 0.5$ V
 DC Input Voltage -0.5 V to $V_{DD} + 0.5$ V

Storage Temperature -65 °C to +150 °C
 Max. Soldering Temperature (10 sec.) 260 °C
 Junction Temperature 150 °C

Operating Conditions

Parameter	Description	Min	Max	Unit
V_{DD}	Supply Voltage	3.0	3.6	V
T_A	Operating Temperature (Ambient Temperature)	-40	85	°C
C_L	Load Capacitance	-	25	pF
C_{IN}	Input Capacitance	-	7	pF
BUF_IN, OUTPUT [1:4]	Operating Frequency	DC	140	MHz
$t_{PU}^{[1]}$	Power-up time for all VDD's to reach minimum specified voltage (power ramps must be monotonic)	0.05	50	ms

Electrical Characteristics

Parameter	Description	Test Conditions	Min	Max	Unit
V_{IL}	Input LOW Voltage ^[2]		-	0.8	V
V_{IH}	Input HIGH Voltage ^[2]		2.0	-	V
I_{IL}	Input LOW Current	$V_{IN} = 0$ V	-5	5	μA
I_{IH}	Input HIGH Current	$V_{IN} = V_{DD}$	-5	5	μA
V_{OL}	Output LOW Voltage ^[3]	$I_{OL} = 24$ mA	-	0.8	V
		$I_{OL} = 12$ mA	-	0.55	V
V_{OH}	Output HIGH Voltage ^[3]	$I_{OH} = -24$ mA	2.0	-	V
		$I_{OH} = -12$ mA	2.4	-	V
I_{DD}	Supply Current	Unloaded outputs at 66.66 MHz	-	25	mA

Thermal Resistance

Parameter ^[4]	Description	Test Conditions	8-pin TSSOP	Unit
θ_{JA}	Thermal resistance (junction to ambient)	Test conditions follow standard test methods and procedures for measuring thermal impedance, in accordance with EIA/JESD51.	165	°C/W
θ_{JC}	Thermal resistance (junction to case)		33	°C/W

Notes

1. This operating condition guarantees skew and propagation delay.
2. BUF_IN input has a threshold voltage of $V_{DD}/2$.
3. Parameter is guaranteed by design and characterization. It is not 100% tested in production.
4. These parameters are guaranteed by design and are not tested.

Switching Characteristics

For Commercial and Industrial Temperature Devices which are characterized over the frequency range of 1 MHz to 140 MHz.

Parameter ^[5]	Name	Description	Min	Typ	Max	Unit
	Duty Cycle ^[6] = $t_2 \div t_1$	Measured at 1.5 V	40.0	50.0	60.0	%
t_3	Rise Time ^[6]	Measured between 0.8 V and 2.0 V	–	–	1.50	ns
t_4	Fall Time ^[6]	Measured between 0.8 V and 2.0 V	–	–	1.50	ns
t_5	Output to Output Skew ^[6]	All outputs equally loaded	–	60	100	ps
t_6	Propagation Delay, BUF_IN Rising Edge to OUTPUT Rising Edge ^[6]	Measured at $V_{DD}/2$	2.5	3.5	5	ns

Switching Waveforms

Figure 1. Duty Cycle Timing

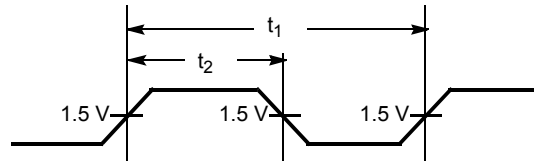

Figure 2. All Outputs Rise/Fall Time

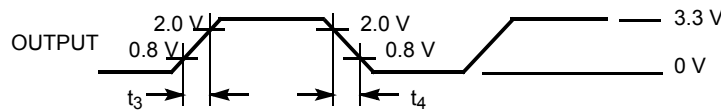

Figure 3. Output-Output Skew

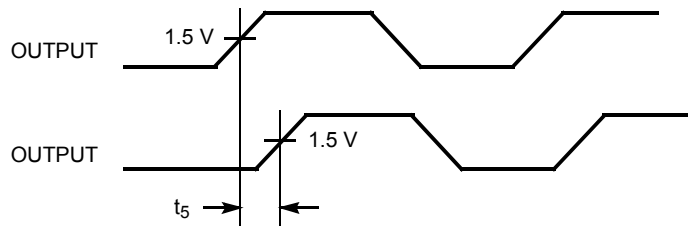
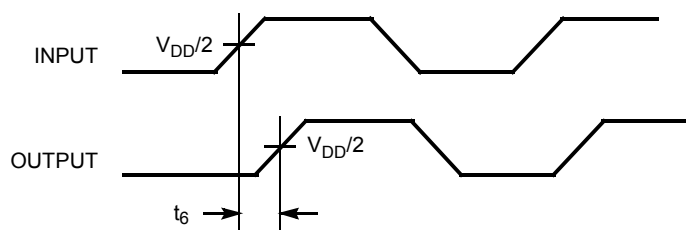

Figure 4. Input-Output Propagation Delay



Notes

- 5. All parameters specified with loaded outputs.
- 6. Parameter is guaranteed by design and characterization. It is not 100% tested in production.

Ordering Information

Ordering Code	Package Type	Operating Range
Standard		
CY2304NZZI-1	8-pin TSSOP	Industrial, -40 °C to 85 °C
CY2304NZZI-1T	8-pin TSSOP – Tape and Reel	Industrial, -40 °C to 85 °C
Pb-free		
CY2304NZZXC-1	8-pin TSSOP	Commercial, 0 °C to 70 °C
CY2304NZZXC-1T	8-pin TSSOP – Tape and Reel	Commercial, 0 °C to 70 °C
CY2304NZZXI-1	8-pin TSSOP	Industrial, -40 °C to 85 °C
CY2304NZZXI-1T	8-pin TSSOP – Tape and Reel	Industrial, -40 °C to 85 °C

Ordering Code Definitions

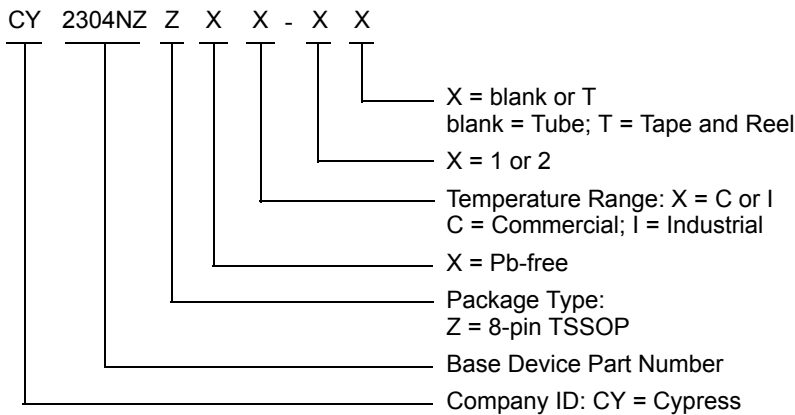

Package Diagram

Figure 5. 8-pin TSSOP (4.40 mm Body) Z08.173/ZZ08.173 Package Outline, 51-85093

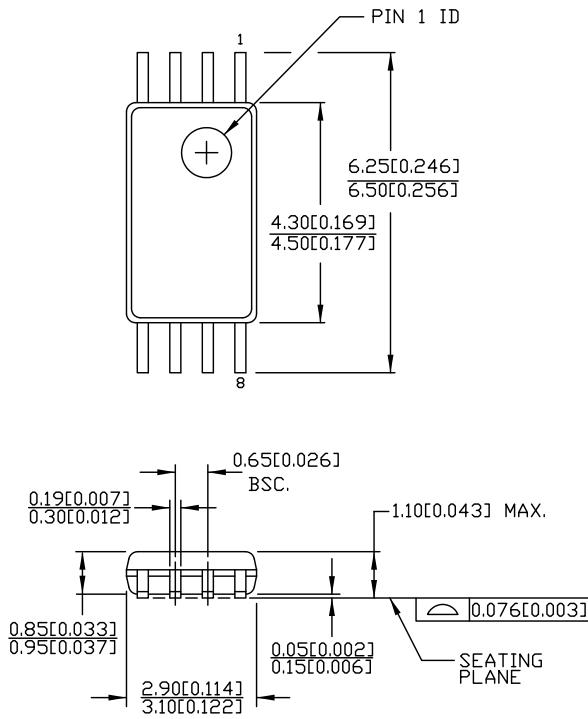

DIMENSIONS IN MM [INCHES] MIN. MAX.

REFERENCE JEDEC MO-153

PART #	
Z08.173	STANDARD PKG.
ZZ08.173	LEAD FREE PKG.

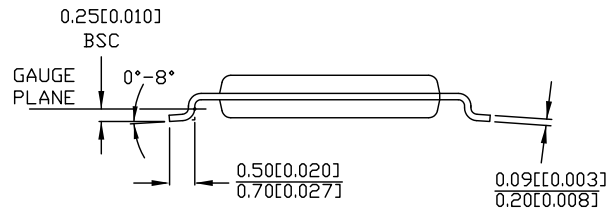

51-85093 *E

Acronyms

Acronym	Description
PCI	Peripheral Component Interconnect
TSSOP	Thin-Shrink Small Outline Package

Document Conventions

Units of Measure

Symbol	Unit of Measure
°C	degree Celsius
Hz	hertz
MHz	megahertz
μA	microampere
mA	milliampere
ms	millisecond
mV	millivolt
ns	nanosecond
Ω	ohm
%	percent
pF	picofarad
ps	picosecond
V	volt
W	watt

Document History Page

Document Title: CY2304NZ, Four Output PCI-X and General Purpose Buffer Document Number: 38-07099				
Rev.	ECN No.	Issue Date	Orig. of Change	Description of Change
**	111420	02/12/02	IKA	New data sheet.
*A	118610	09/25/02	HWT	Updated Ordering Information : Added Industrial Temperature Range in the Ordering Information.
*B	121820	12/14/02	RBI	Updated Operating Conditions : Added t_{PU} parameter and its details.
*C	291098	See ECN	RGL	Updated Switching Characteristics : Specified typical value for "Output to Output Skew" parameter. Updated Ordering Information : Added Lead-free Devices.
*D	2904623	04/05/10	CXQ	Updated Ordering Information (Removed inactive parts). Updated Package Diagram .
*E	3163624	02/05/2011	CXQ	Updated Maximum Ratings (Removed reference to "Except REF" and "REF" for DC Input Voltage spec). Added Ordering Code Definitions . Updated Package Diagram . Added Acronyms and Units of Measure . Updated to new template.
*F	3931498	04/08/2013	PURU	Updated Maximum Ratings : Removed "Static Discharge Voltage" and its related information. Updated Package Diagram : spec 51-85093 – Changed revision from *C to *D.
*G	4103402	08/23/2013	MNSB	Updated Operating Conditions : Added Note 1 and referred the same note in t_{PU} parameter. Updated to new template.
*H	4312848	03/18/2014	CINM	No technical updates. Completing Sunset Review.
*I	4578443	11/25/2014	AJU	Updated Functional Description : Added "For a complete list of related documentation, click here ." at the end. Updated Package Diagram : spec 51-85093 – Changed revision from *D to *E.
*J	4756553	05/06/2015	TAVA	Updated Switching Characteristics : Replaced "For Commercial and Industrial Temperature Devices" with "For Commercial and Industrial Temperature Devices which are characterized over the frequency range of 1 MHz to 140 MHz." for characterization.
*K	5258800	05/04/2016	PSR	Added Thermal Resistance . Updated to new template.

Sales, Solutions, and Legal Information

Worldwide Sales and Design Support

Cypress maintains a worldwide network of offices, solution centers, manufacturer's representatives, and distributors. To find the office closest to you, visit us at [Cypress Locations](#).

Products

ARM® Cortex® Microcontrollers	cypress.com/arm
Automotive	cypress.com/automotive
Clocks & Buffers	cypress.com/clocks
Interface	cypress.com/interface
Lighting & Power Control	cypress.com/powerpsoc
Memory	cypress.com/memory
PSoC	cypress.com/psoc
Touch Sensing	cypress.com/touch
USB Controllers	cypress.com/usb
Wireless/RF	cypress.com/wireless

PSoC® Solutions

[PSoC 1](#) | [PSoC 3](#) | [PSoC 4](#) | [PSoC 5LP](#)

Cypress Developer Community

[Forums](#) | [Projects](#) | [Video](#) | [Blogs](#) | [Training](#) | [Components](#)

Technical Support

cypress.com/support

© Cypress Semiconductor Corporation, 2002-2016. This document is the property of Cypress Semiconductor Corporation and its subsidiaries, including Spansion LLC ("Cypress"). This document, including any software or firmware included or referenced in this document ("Software"), is owned by Cypress under the intellectual property laws and treaties of the United States and other countries worldwide. Cypress reserves all rights under such laws and treaties and does not, except as specifically stated in this paragraph, grant any license under its patents, copyrights, trademarks, or other intellectual property rights. If the Software is not accompanied by a license agreement and you do not otherwise have a written agreement with Cypress governing the use of the Software, then Cypress hereby grants you a personal, non-exclusive, nontransferable license (without the right to sublicense) (1) under its copyright rights in the Software (a) for Software provided in source code form, to modify and reproduce the Software solely for use with Cypress hardware products, only internally within your organization, and (b) to distribute the Software in binary code form externally to end users (either directly or indirectly through resellers and distributors), solely for use on Cypress hardware product units, and (2) under those claims of Cypress's patents that are infringed by the Software (as provided by Cypress, unmodified) to make, use, distribute, and import the Software solely for use with Cypress hardware products. Any other use, reproduction, modification, translation, or compilation of the Software is prohibited.

TO THE EXTENT PERMITTED BY APPLICABLE LAW, CYPRESS MAKES NO WARRANTY OF ANY KIND, EXPRESS OR IMPLIED, WITH REGARD TO THIS DOCUMENT OR ANY SOFTWARE OR ACCOMPANYING HARDWARE, INCLUDING, BUT NOT LIMITED TO, THE IMPLIED WARRANTIES OF MERCHANTABILITY AND FITNESS FOR A PARTICULAR PURPOSE. To the extent permitted by applicable law, Cypress reserves the right to make changes to this document without further notice. Cypress does not assume any liability arising out of the application or use of any product or circuit described in this document. Any information provided in this document, including any sample design information or programming code, is provided only for reference purposes. It is the responsibility of the user of this document to properly design, program, and test the functionality and safety of any application made of this information and any resulting product. Cypress products are not designed, intended, or authorized for use as critical components in systems designed or intended for the operation of weapons, weapons systems, nuclear installations, life-support devices or systems, other medical devices or systems (including resuscitation equipment and surgical implants), pollution control or hazardous substances management, or other uses where the failure of the device or system could cause personal injury, death, or property damage ("Unintended Uses"). A critical component is any component of a device or system whose failure to perform can be reasonably expected to cause the failure of the device or system, or to affect its safety or effectiveness. Cypress is not liable, in whole or in part, and you shall and hereby do release Cypress from any claim, damage, or other liability arising from or related to all Unintended Uses of Cypress products. You shall indemnify and hold Cypress harmless from and against all claims, costs, damages, and other liabilities, including claims for personal injury or death, arising from or related to any Unintended Uses of Cypress products.

Cypress, the Cypress logo, Spansion, the Spansion logo, and combinations thereof, PSoC, CapSense, EZ-USB, F-RAM, and Traveo are trademarks or registered trademarks of Cypress in the United States and other countries. For a more complete list of Cypress trademarks, visit cypress.com. Other names and brands may be claimed as property of their respective owners.