

PCM-3350 Series

NS Geode 586-Level PC/104
CPU Module with SVGA/LCD/
LAN Interface

User's Manual

Copyright notice

This document is copyrighted, 2001, by Advantech Co., Ltd. All rights are reserved. The original manufacturer reserves the right to make improvements to the products described in this manual at any time without notice.

No part of this manual may be reproduced, copied, translated or transmitted in any form or by any means without the prior written permission of the original manufacturer. Information provided in this manual is intended to be accurate and reliable. However, the original manufacturer assumes no responsibility for its use, nor for any infringements upon the rights of third parties which may result from its use.

Acknowledgements

AMD is a trademark of Advanced Micro Devices, Inc.

Award is a trademark of Award Software International, Inc.

Cyrix is a trademark of Cyrix Corporation.

IBM, PC/AT, PS/2 and VGA are trademarks of International Business Machines Corporation.

Intel and Pentium are trademarks of Intel Corporation.

Microsoft Windows® is a registered trademark of Microsoft Corp.

RTL is a trademark of Realtek Semiconductor Co., Ltd.

C&T is a trademark of Chips and Technologies, Inc.

UMC is a trademark of United Microelectronics Corporation.

Winbond is a trademark of Winbond Electronics Corp.

STPC is a trademark of SGS Thomson Corp.

For more information on this and other Advantech products, please visit our website at: **<http://www.advantech.com>**

For technical support and service, please visit our support website at: **<http://www.advantech.com/support>**

This manual is for the PCM-3350P, PCM-3350F.

Part No. 2006335000

1st Edition Printed in Taiwan May 2001

Packing list

Before you begin installing your card, please make sure that the following materials have been shipped:

- 1 PCM-3350 All-in-one single board computer
- 1 Start-up manual
- CD-ROM or Disks for utility, drivers, and manual (in PDF format)
- 1 2.5" IDE flat cable, 44-pin to 44-pin (product no. 1701440350)
- 1 PS/2 keyboard & mouse cable (product no. 1700060202)
- 2 serial port cables (product no. 1700100250)
- 1 cable 6P - 6P (product no. 1703060053)
- 1 parallel cable (product no. 1700260250)
- 1 26-34 pin FDD cable converter (product no. 9681000044)
- 1 floppy cable, for 3.5" FDD only (product no. 1701340501)
- 1 FDD flat cable (product no. 1906000001)
- 1 VGA cable (product no. 1701160150)
- 1 LAN cable (product no. 1701100202)
- 1 warranty certificate

If any of these items are missing or damaged, contact your distributor or sales representative immediately.

Contents

Chapter 1	General Information	1
1.1	Introduction	2
1.2	Features	3
1.3	Specifications	4
	1.3.1 Standard SBC functions	4
	1.3.2 VGA function	4
	1.3.4 Ethernet function	5
	1.3.5 Solid state disk	5
	1.3.6 Mechanical and environmental	5
1.4	Board dimensions	6
Chapter 2	Installation	7
2.1	Connectors	8
2.2	Locating connectors	9
2.3	Safety precautions	10
2.4	Ethernet connector (CN1) (PCM-3350F/N only).....	10
	2.4.1 Ethernet connector (CN1).....	10
	2.4.2 Network boot.....	10
2.5	LCD display connector (CN2).....	10
2.6	Serial ports (CN3: COM1; CN4: COM2/RS-232; CN18: COM2/RS-422/485)	11
	2.6.1 RS-232 connection (COM1: CN3)	11
	2.6.2 RS-232/422/485 connection (COM2: CN4: RS-232; CN18: RS-422/485).....	11
2.7	EIDE HDD connector (CN5)	12
	2.7.1 Connecting the hard drive	12
2.8	PC/104 connector (CN6).....	12
2.9	Parallel port connector (CN7)	13
2.10	Backlight connector (CN8).....	13

2.11	VGA connector (CN9)	13
2.11.1	CRT display connector (CN9)	13
2.12	Main power (+5 V / +12 V) connector (CN11)	13
2.13	PS/2 keyboard/mouse connector (CN12)	14
2.14	FDD connector (CN14)	14
2.14.1	Connecting the floppy drive	14
2.15	CompactFlash™ socket (CN16)	15
2.16	USB connector (CN17)	15
2.17	Multifunction Jumpers (MJ1)	16
2.17.1	Auxiliary power connector (MJ1-A)	16
2.17.2	Fan connector (MJ1-B)	17
2.17.3	Reset button connector (MJ1-C)	17
2.17.4	IR connector (MJ1-D)	17
2.17.5	Watchdog timer configuration (MJ1-E)	17
2.18	SO DIMM socket (Slot1)	18
2.18.1	Installing SODIMMs	18

Chapter 3 Software Configuration **21**

3.1	Introduction	22
3.2	Utility CD disk	22
3.3	VGA display software configuration	22
3.4	Connections for two standard LCDs	24
3.4.1	Connections for Toshiba LTM10C042(640 x 480 TFT color LCD)	24
3.4.2	Connections for Toshiba LTM12C275A (800 x 600 TFT color LCD)	25

Chapter 4 Award BIOS Setup **27**

4.1	System test and initialization	28
4.1.1	System configuration verification	28
4.2	Award BIOS setup	29
4.2.1	Entering setup	29
4.2.2	Standard CMOS setup	30
4.2.3	BIOS features setup	31
4.2.4	Chipset features setup	32

4.2.5	Power management setup	33
4.2.6	PnP/PCI configuration	34
4.2.7	Integrated peripherals	35
4.2.8	Change password	36
4.2.9	Save & exit setup	37
4.2.10	Exit without saving	37
Chapter 5	PCI Bus Ethernet Interface	39
5.1	Introduction	40
5.2	Installation of Ethernet driver	40
5.2.2	Installation for Windows 98/2000	41
5.3	Further information	44
Chapter 6	SVGA Setup	45
6.1	Introduction	46
6.1.1	Chipset	46
6.1.2	Display memory	46
6.2	Installation of SVGA driver	46
6.2.1	Installation for Cyrix MediaGX Certified drivers for Windows 95/98. Insert the disk into the CD-ROM drive. ..	47
6.2.2	Installation for Windows NT	50
6.3	Further information	56
Appendix A	Programming the Watchdog Timer	57
A.1	Programming the watchdog timer	58
Appendix B	Installing PC/104 Modules	61
B.1	Installing PC/104 modules	62
Appendix C	Pin Assignments	65
C.1	Ethernet connector (CN1)	66
C.2	LCD connector (CN2)	67
C.3	COM1 connector (CN3)	68
C.4	COM2 connector (CN4)	68
C.5	EIDE hard drive connector (CN5)	69

C.6	PC/104 connector (CN6)	70
C.7	Parallel port connector (CN7)	70
C.8	Backlight connector (CN8)	71
C.9	VGA connector (CN9)	71
C.10	Main power (+5 V) connector (CN11)	72
C.11	PS/2 keyboard/mouse connector (CN12)	72
C.12	FDD connector (CN14)	73
C.13	CompactFlash™ socket (CN16)	74
C.14	COM2 connector for 422/485 (CN18)	76
C.15	Multifunction Jumper (MJ1)	76

Appendix D System Assignments 79

D.1	System I/O ports	80
D.2	DMA channel assignments	81
D.3	Interrupt assignments	82
D.4	1st MB memory map	83

Appendix E LCD Services 85

E.1	LCD services	86
-----	--------------------	----

Figures

Figure 1-1: PCM-3350 dimensions	6
Figure 2-1: Locating connectors (component side)	9
Figure 2-2: Locating connectors (solder side)	9
Figure 3-1: Contents of the PCM-3350 Series utility disk	22
Figure 3-2: BIOS VGA setup screen	23
Figure 4-1: BIOS setup program initial screen	29
Figure 4-2: CMOS setup screen	30
Figure 4-3: BIOS features setup	31
Figure 4-4: Chipset features setup	32
Figure 4-5: Power management setup	33
Figure 4-6: PnP/PCI configuration	34
Figure 4-7: Integrated peripherals	35
Figure B-1: PC/104 module mounting diagram	63
Figure B-2: PC/104 module dimensions (mm) (± 0.1)	63
Figure C-1: CompactFlash™ socket	75

Tables

Table 2-1: Connectors	8
Table 2-2: Serial port connections (COM1, COM2)	11
Table 2-3: Serial port default settings	12
Table B-1: PCM-3350 PC/104 connectors (CN6)	64
Table C-1: Ethernet connector (CN1)	66
Table C-2: LCD connector (CN2)	67
Table C-3: COM1 connector (CN3)	68
Table C-4: COM2 connector (CN4)	68
Table C-5: EIDE hard drive connector (CN5)	69
Table C-7: Parallel port connector (CN7)	70
Table C-9: VGA connector (CN11)	71
Table C-8: Backlight connector (CN8)	71
Table C-10: Main power (+5 V) connector (CN11)	72
Table C-11: PS/2 keyboard/mouse connector (CN12)	72
Table C-12: FDD connector (CN14)	73
Table C-13: CompactFlash™ socket (CN16)	74
Table C-14: COM2 connector for 422/485 (CN18)	76
Table C-15: MJ1-A, -5 V, -12 V input	76
Table C-16: MJ1-B, fan connector	76
Table C-18: MJ1-D, IR connector	77
Table C-19: MJ1-E, watchdog jumper	77
Table C-17: MJ1-C, reset button	77
Table D-1: System I/O ports	80
Table D-2: DMA channel assignments	81
Table D-3: Interrupt assignments	82
Table D-4: 1st MB memory map	83

CHAPTER 1

General Information

This chapter gives background information on the PCM-3350.

Sections include:

- Introduction
- Features
- Specifications
- Board dimensions

1.1 Introduction

The PCM-3350 is the ultimate cost-effective solution for limited space applications. It is a new NS Geode Biscuit PC with enhanced graphics function. It uses a NS CS5530A chipset which supports TFT LCDs. It offers all the functions of an AT-compatible industrial computers on a single board. The PCM-3350 comes with an embedded high-performance GX1-300 processor on-board. For maximum performance, the PCM-3350 Series also supports an SDRAM SODIMM socket that can accept up to 128 MB memory.

On-board features include an Ethernet interface, socket for Compact Flash Card, Enhanced IDE interface with up to Ultra DMA transfer protocol, one parallel port, two serial ports (RS-232 and RS-232/422/485) and a PS/2 keyboard/mouse interface. A SVGA/LCD display controller (LCD, and CRT displays) allows LCD screen resolutions up to 1024 x 768 and CRT resolutions up to 1280 x 1024 @ 16 colors.

The PCM-3350 complies with the "Green Function" standard and supports three types of power saving features: Normal, Doze, and Sleep modes.

The display type configuration is done through the software. A single Flash chip holds the system BIOS and the VGA BIOS. This minimizes the chip usage and eases configuration. You can change the display BIOS simply by programming the Flash chip.

If you need additional functions, the PCM-3350 has a PC/104 connector for future upgrades.

1.2 Features

- Ultra-compact size single board computer, smaller than a 3½" hard disk drive (96 mm x 90 mm)
- Onboard NS Geode GX1 300MHz CPU
- Up to 128 MB system memory, by way of SODIMM (SDRAM)
- Onboard VGA/18-bit LCD interface
- Supports CompactFlash™ card
- Built-in Enhanced IDE (AT bus) hard disk drive interface
- Onboard PS/2 keyboard/mouse connector
- Two serial ports (RS-232)
- Upgradeable through PC/104 module
- Green engine with sleep mode and low power consumption
- +5 V power supply (for CPU board), +12 V power supply (for PC/104, backlight)
- Onboard 10/100Base-T Ethernet interface

1.3 Specifications

1.3.1 Standard SBC functions

- **CPU:**
Embedded Low power NS Geode GX1-300 MHz processor
- **BIOS:** AWARD 256 KB Flash memory
- **System memory:** One 144-pin SODIMM socket accepts up to 128 MB SDRAM
- **Enhanced IDE interface:** Supports up to two EIDE devices. BIOS auto-detect, PIO Mode 3 or Mode 4 transfer, Ultra DMA33 mode (ATA-4) up to 33 MB/sec
- **FDD interface:** Supports up to two FDDs/ 2.5" FDD
- **Serial ports:** One serial RS-232 port, one serial RS-232/422/485 port
- **Parallel port:** One parallel port, supports SPP/EPP/ECP mode
- **Infrared port:** Shared with COM 2. Transfer rate up to 115 kbps
- **Keyboard/mouse connector:** Mini-DIN connector supports standard PS/2 keyboard and mouse
- **USB interface:** Two USB ports, USB 1.0 compliant
- **Power management:** Supports power saving modes including Normal/Standby/Suspend. APM 1.1 compliant
- **Watchdog timer:** 1.6 sec. intervals

1.3.2 VGA function

- **Chipset:** NS CS5530A
- **Display memory:** 1 ~ 4 MB share memory, set in BIOS
- **Display type:** Supports CRT and TFT LCDs. Able to display both CRT and flat panel simultaneously
- **Flat-panel display mode:** Panel resolution supports up to 1024 x 768 @ 18 bpp. Supports 18-bit TFT LCD panel

- **CRT display mode:** Non-interlaced CRT monitor resolutions up to 1024 x 768 @ 24 bpp

1.3.4 Ethernet function

- **Chipset:** Intel 82559 ER
- **Ethernet interface:** PCI 10/100 Mbps Ethernet. IEEE 802.3 U protocol compatible
- **Connection:** On-board 2 x 5 2.0 mm connector
- **I/O address switchless setting**
- **Built-in boot ROM**

1.3.5 Solid state disk

- Supports CompactFlash™ cards

1.3.6 Mechanical and environmental

- **Dimensions: (L x W):** 96 mm x 90 mm (3.77" x 3.54")
- **Weight:** .11 kg (.24 lb)
- **Operating temperature:** 0° ~ 60° C (32 ~ 140° F)
- **Storage temperature:** -40° ~ 85° C (-40 ~ 185° F)
- **Operating humidity:** 0% to 95% relative humidity, noncondensing
- **Power supply voltage:** + 5 V ± 5 %
- **Power requirements:** 2.0 A + 5 V, Max w/GX1-300 MHz CPU & 64 MB

1.4 Board dimensions

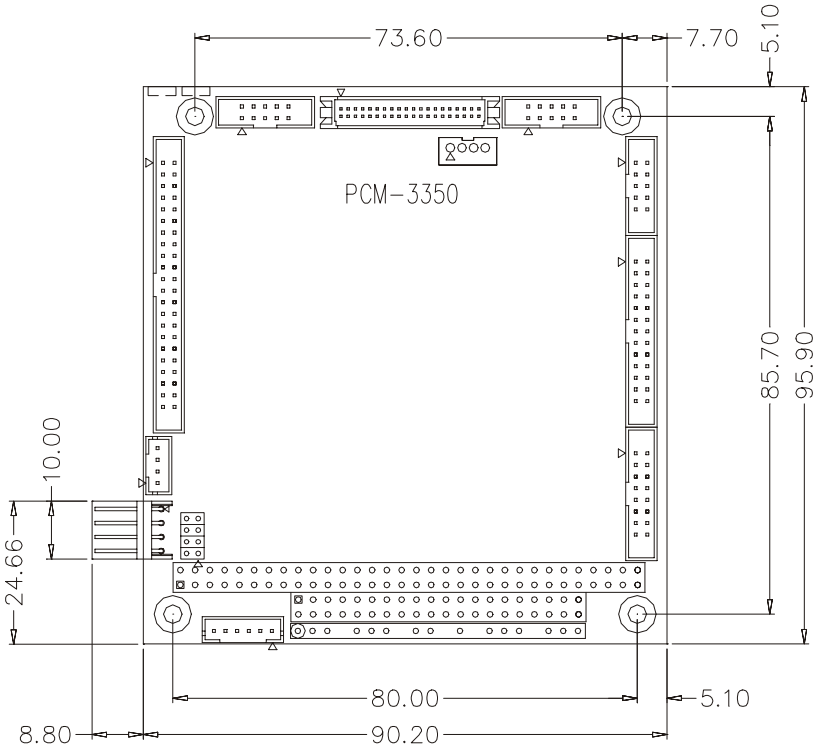

Figure 1-1: PCM-3350 dimensions

CHAPTER 2

Installation

This chapter tells how to set up the PCM-3350 hardware. It includes instructions on setting jumpers and connecting peripherals, switches and indicators. Make sure you read all the safety precautions before you begin the installation procedure.

2.1 Connectors

The board has a number of connectors that allow you to configure your system to suit your application.

The tables below shows the function of each of the board's connectors:

Table 2-1: Connectors

Label	Function
CN1	Ethernet connector
CN2	LCD connector
CN3	COM1 connector
CN4	COM2 connector
CN5	EIDE HDD connector
CN6	PC/104 connector
CN7	Parallel port connector
CN8	Backlight connector
CN9	VGA connector
CN11	Main power (+5 V) connector
CN12	PS/2 keyboard/mouse connector
CN14	FDD connector
CN16	CompactFlash™ socket
CN17	USB Connector
CN18	COM2 RS422/485 connector
MJ1	Multifunction Jumper
Slot 1	SODIMM socket

2.2 Locating connectors

Warning: *Make sure you use the correct component side. Improper installation can cause serious damage to your hardware!*

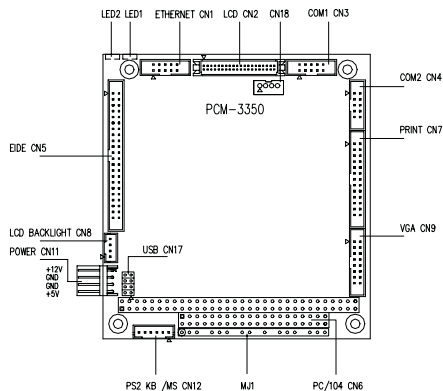

Figure 2-1: Locating connectors (component side)

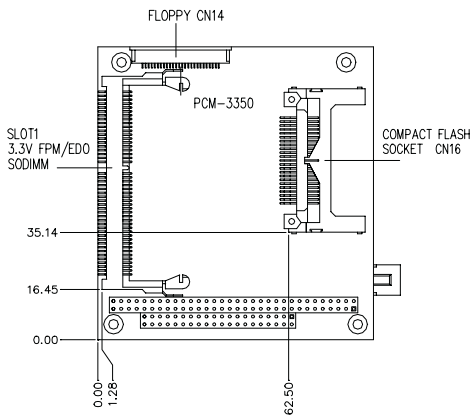



Figure 2-2: Locating connectors (solder side)

2.3 Safety precautions

Warning!  Always completely disconnect the power cord from your board whenever you are working on it. Do not make connections while the power is on, because sensitive electronic components can be damaged by a sudden rush of power.

Caution!  Always ground yourself to remove any static charge before touching the board. Modern electronic devices are very sensitive to static electric charges. Use a grounding wrist strap at all times. Place all electronic components on a static-dissipative surface or in a static-shielded bag when they are not in the chassis.

2.4 Ethernet connector (CN1) (PCM-3350F/N only)

The PCM-3350F/N is equipped with a high performance 32-bit PCI-bus Fast Ethernet interface which is fully compliant with IEEE 802.3u 100/10Base-T specifications. It is supported by all major network operating systems.

2.4.1 Ethernet connector (CN1)

10/100Base-T connects to the PCM-3350F/N via an adapter cable to the 10-pin 2 mm connector.

2.4.2 Network boot

The network boot feature is built into the BIOS. It can be enabled or disabled in the chipset setup of the CMOS configuration. Refer to "BIOS Setting" in Chapter 4 for more information.

2.5 LCD display connector (CN2)

CN2 is a 40-pin dual-in-line header and is used to connect an LCD display.

2.6 Serial ports (CN3: COM1; CN4: COM2/RS-232; CN18: COM2/RS-422/485)

The PCA-3350F offers two serial ports: COM1 in RS-232 and COM2 (CN4: RS-232, CN18:RS-422/485). Refer to CMOS "Integrated Peripheral" for RS-232, 422 or 485 settings. These ports let you connect to serial devices (mouse, printers, etc.) or a communication network.

You can select the address for each port (for example, 3F8H [COM1], 2F8H [COM2]) or disable each port. Use the BIOS Advanced Setup program, which is covered in Chapter 4.

The card mounting bracket holds the serial port connector for the one port. The parallel port and serial port adapter kit (supplied with the card) holds the connector for the other port. This lets you connect and disconnect cables after you install the card. The DB-9 connector on the bottom of the bracket is the first RS-232 port, COM1. The DB-9 connector on the adapter kit is the second serial port, COM2.

Table 2-2: Serial port connections (COM1, COM2)

Connector	Function
COM1	RS-232
COM2	RS-232/422/485

2.6.1 RS-232 connection (COM1: CN3)

Different devices implement the RS-232 standard in different ways. If you are having problems with a serial device, be sure to check the pin assignments for the connector.

2.6.2 RS-232/422/485 connection (COM2: CN4: RS-232; CN18: RS-422/485)

COM2 is an RS-232/422/485 serial port. You can select one of these functions via BIOS, as detailed in Chapter 4.

The IRQ and address range for both ports are fixed. However, if you wish to disable the port or change these parameters later, you can do

this in the system BIOS setup. The table below shows the settings for the PCA-3350F Series' board's ports:

Table 2-3: Serial port default settings

Port	Address	Interrupt	Default
COM1	3F8, 3E8	IRQ4	3F8
COM2	2F8, 2E8	IRQ3	2F8

2.7 EIDE HDD connector (CN5)

The built-in Enhanced IDE (Integrated Device Electronics) controller supports up to two IDE devices, including CD-ROM drives, tape backup drives, a large hard disk drive and other IDE devices.

2.7.1 Connecting the hard drive

Connecting drives is done in a daisy-chain fashion. It requires one or two cables, depending on the drive size. All necessary cables are included in your PCM-3350 package. 1.8" and 2.5" drives need a 1 x 44-pin to 2 x 44-pin flat-cable connector. 3.5" drives need a 1 x 44-pin to 2 x 40-pin connector.

Wire number 1 on the cable is red or blue, and the other wires are gray.

1. Connect one end of the cable to CN5. Make sure that the red (or blue) wire corresponds to pin 1 on the connector, which is labeled on the board (on the right side).
2. Plug the other end of the cable into the Enhanced IDE hard drive, with pin 1 on the cable corresponding to pin 1 on the hard drive. Unlike floppy drives, IDE hard drives can connect to either end of the cable. If you install two drives, you will need to set one as the master and one as the slave by using jumpers on the drives. If you install just one drive, set it as the master.

2.8 PC/104 connector (CN6)

Refer to Appendix B in this manual.

2.9 Parallel port connector (CN7)

Normally, the parallel port is used to connect the card to a printer. The PCM-3350 includes a multi-mode (ECP/EPP/SPP) parallel port. It is accessed via CN7, a 26-pin flat-cable connector.

You will need an adapter cable if you use a traditional DB-25 connector. The adapter cable should have a 26-pin connector on one end and a DB-25 connector on the other.

The parallel port interrupt channel is designated as IRQ7.

2.10 Backlight connector (CN8)

The LCD inverter is connected to CN8 via a 4-pin connector to provide +12 V power to the LCD display.

2.11 VGA connector (CN9)

The PCM-3350 board's SVGA interface can facilitate conventional CRT displays. The card has a connector to support CRT VGA monitors.

2.11.1 CRT display connector (CN9)

CN9 is a 16-pin, pin head housing connector. Please use the VGA cable (provided with your kit) to convert the pin head housing connector into a connector for conventional CRT displays.

Detailed information on pin assignments for CRT display connector CN9 is given in Appendix C.

2.12 Main power (+5 V / +12 V) connector (CN11)

This supplies main power to the PCM-3350 (+5 V), and also 12 V power to the backlight connector.

2.13 PS/2 keyboard/mouse connector (CN12)

The PCM-3350 board provides a pin head keyboard connector, which supports both a keyboard and a PS/2 style mouse. In most cases, especially in embedded applications, a keyboard is not used. If the keyboard is not present, the standard PC/AT BIOS will report an error or failure during the power-on self test (POST) after resetting the PC. The PCM-3350 board's BIOS standard setup menu allows you to select "Absent/Present" for your keyboard under the Advanced CMOS Setup section. This allows non-keyboard operation in embedded system applications without the system halting during the POST. When "PS/2 mouse support" is enabled, your PS/2 mouse is automatically detected by the system.

2.14 FDD connector (CN14)

You can attach one 3.5" floppy drive to the the PCM-3350's onboard controller. This is useful for notebooks, for example.

A daisy-chain drive cable converter (part no. 9681000044) is required for a single floppy system. A 34-pin flat-cable connector is fitted on one end of the cable converter, while the other end has one floppy disk drive connector. It consists of a 34-pin flat-cable connector (for the 3½" drives).

2.13.1 Connecting the floppy drive

1. Plug the 34-pin flat-cable connector into the cable converter. Make sure that the red wire corresponds to pin 1 on the connector.
2. Attach the appropriate connector at the other end of the cable to the floppy drive(s). You can use only one connector in the set. The set at the other end (after the twist in the cable) connects to the A: drive.

When connecting a 3½" floppy drive, you may have some difficulties in determining which pin is number one. Look for a number on the circuit board indicating pin number one. In addition, you should check if the connector on the floppy drive has an extra slot. If the slot is up,

pin number one should be on the right. Please refer to any documentation that came with the drive for more information.

If your cable needs to be custom made, you can find the pin assignments for the board's connector in Appendix C.

2.15 CompactFlash™ socket (CN16)

The PCM-3350 is equipped with a CompactFlash™ Type I disk socket on the solder side, which supports the IDE interface CompactFlash disk card. The socket itself is specially designed to prevent any incorrect installation of the CompactFlash disk card. When installing or removing the CompactFlash disk card, please make sure that the system power is off.

The CompactFlash™ disk card is defaulted as the E disk drive in your PC system. To fit the Advantech CFC into the PCM-3350, simply plug it into the designated connector. It will only fit when the red triangle on the CFC is aligned with the triangle on the connector. The card will not fit any other way (do NOT use excessive force).

2.16 USB connector (CN17)

The PCM-3350F board provides two USB (Universal Serial Bus) interfaces, which give complete plug and play and also hot attach/detach for up to 127 external devices. The USB interfaces comply with USB specification rev. 1.0 and are fuse protected.

The USB interfaces are accessed through a 8-pin flat-cable connector, CN17. The adapter cable has a 8-pin connector on one end and a USB connector on the bracket.

The USB interfaces can be disabled in the system BIOS setup.

2.17 Multifunction Jumpers (MJ1)

Multifunction jumpers (MJ1)

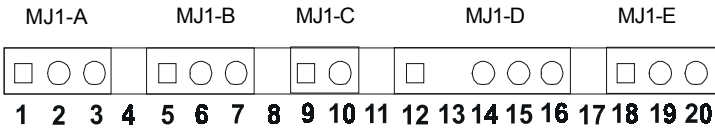

MJ1 Assign	Pins	Function	Notes
MJ1-A	1-3	-5 V, -12 V input	Pin1: -5 V Pin2: GND Pin3: -12 V
MJ1-B	5-7	Fan connect	Pin5: +5 V Pin6: GND Pin7: +12 V
MJ1-C	9-10	System reset button	open: normal closed: reset
MJ1-D	12-16	IR connect	Pin12: Vcc Pin13: NC Pin14: Receive Pin15: GND Pin16: Transmit
MJ1-E	18-20	Watchdog connect	Pin 18-19: IRQ11 Pin 19-20: reset

2.17.1 Auxiliary power connector (MJ1-A)

Supplies secondary power to peripherals that require -5 V and -12 V.

2.17.2 Fan connector (MJ1-B)

The PCM-3350 is equipped with a low power dissipation GX1 CPU. With only a heat sink, the PCM-3350 will operate normally at temperatures up to 60° C. At temperatures above 60° C, a fan is recommended. A CPU fan power supply connector is provided (+5 V input) in addition to the CPU power supply.

This provides power supply to the optional CPU cooling fan. This connector is only available when +5 V power is supplied to the board.

Warning! Before making the connection, make sure that the voltage is absolutely correct and matched with the correct connector.

2.17.3 Reset button connector (MJ1-C)

If you install a reset button, it should be a single pole switch rated at 5 V. Momentarily pressing the button will activate a reset.

For reset button pin assignments, please see Appendix C.

2.17.4 IR connector (MJ1-D)

This connector supports the optional wireless infrared transmitting and receiving module. This module mounts on the system case. You must configure the setting through BIOS setup.

2.17.5 Watchdog timer configuration (MJ1-E)

An onboard watchdog timer reduces the chance of disruptions which EMP (electro-magnetic pulse) interference can cause. This is an invaluable protective device for standalone or unmanned applications. Setup involves two jumpers and running the control software (refer to Appendix A).

When the watchdog timer is enabled and the CPU shuts down, the watchdog timer will automatically either reset the system or generate an interrupt on IRQ11, depending on jumper MJ1-E settings.

2.18 SO DIMM socket (Slot1)

You can install anywhere from 8 MB to 128 MB of onboard SDRAM memory using 8, 16, 32 or 128 MB 144-pin SODIMMs (Small Outline Dual Inline Memory Modules).

2.18.1 Installing SODIMMs

Note: *The modules can only fit into a socket one way. Their gold pins must point down into the SODIMM socket.*

The procedure for installing SODIMMs appears below. Please follow these steps carefully.

SO DIMM installation

1. Make sure that all power supplies to the system are switched off.
2. Install the SODIMM card. Install the SODIMM so that its gold pins point down into the SODIMM socket.
3. Slip the SODIMM into the socket at a 45 degree angle and carefully fit the bottom of the card against the connectors.
4. Gently push the SODIMM into a perpendicular position until the clips on the ends of the SODIMM sockets snap into place.
5. Check to ensure that the SODIMM is correctly seated and all connector contacts touch. The SODIMM should not move around in its socket.

Important: *Only use standard form SODIMM memory modules (as shown in the diagram below). Standardized dimensions ensure a proper fit. Check with your memory supplier about the SODIMM modules you will use.*

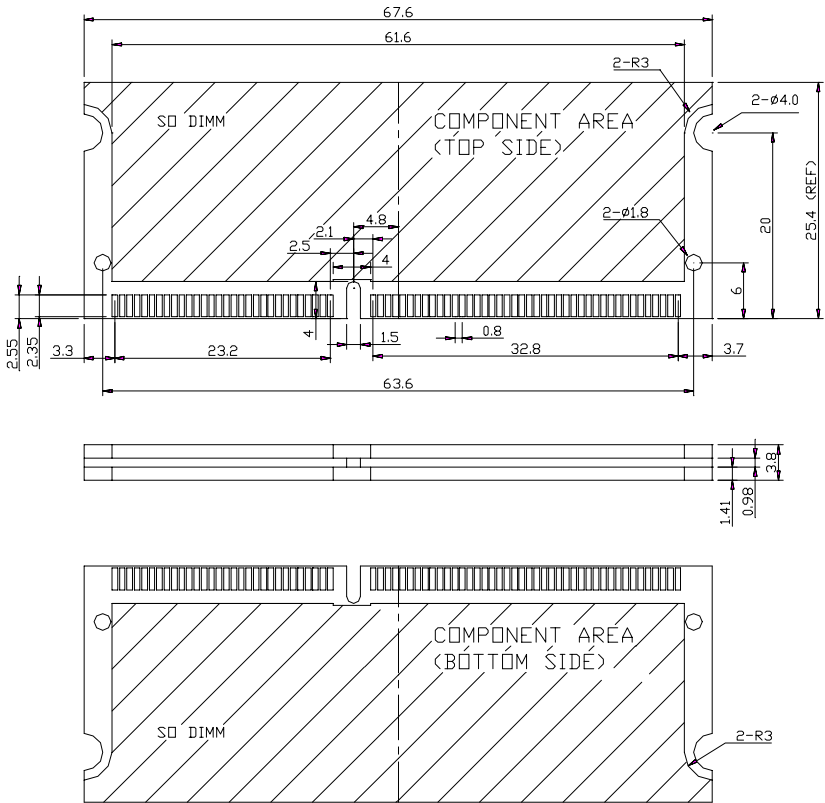

CHAPTER 3

Software Configuration

This chapter details the software configuration information. It shows you how to configure the card to match your application requirements. Award system BIOS is covered in Chapter 4.

Sections include:

- LCD display configuration
- Connections for two standard LCDs

3.1 Introduction

The PCM-3350 system BIOS and custom drivers are located in a 256 KB, 32-pin Flash ROM device, designated U17. A single Flash chip holds the system BIOS and VGA BIOS. The display type can be configured via software. This method minimizes the number of chips and eases configuration. You can change the display BIOS simply by reprogramming the Flash chip.

3.2 Utility CD disk

The PCM-3350 is supplied with a software utility on CD-ROM. This disk contains the necessary file for setting up the VGA display. Directories and files on the disk are as follows:

```
├── AWDFLASH.EXE
├── CBROM.EXE
└── 3350Vxxx.BIN
```

Figure 3-1: Contents of the PCM-3350 Series utility disk

AWDFLASH.EXE

This program allows you to update the BIOS Flash ROM.

3350110.BIN

This binary file contains the system BIOS.

CBROM.EXE

This program allows you to combine your own VGA BIOS with system BIOS (3350V110.BIN).

3.3 VGA display software configuration

The PCM-3350 on-board VGA/LCD interface supports an 18-bit TFT LCD, flat panel displays and traditional analog CRT monitors. The interface can drive CRT displays with resolutions up to 1024 x 768 in 24 bpp. It is also capable of driving color panel displays with resolutions of 1024 x 768 in 18 bpp. The LCD type is configured completely via the software utility, so you do not have to set any jumpers. Configure the LCD type as follows:

1. Apply power to the PCM-3350 Series with a color TFT display attached. This is the default setting for the PCM-3350 series. Make sure that the AWDFLASH.EXE and *.BIN files are located in the working drive.

Note: *Make sure that you do not run AWDFLASH.EXE while your system is operating in EMM386 mode.*

2. At the prompt, type AWDFLASH.EXE and press <Enter>. The VGA configuration program will then display the following:

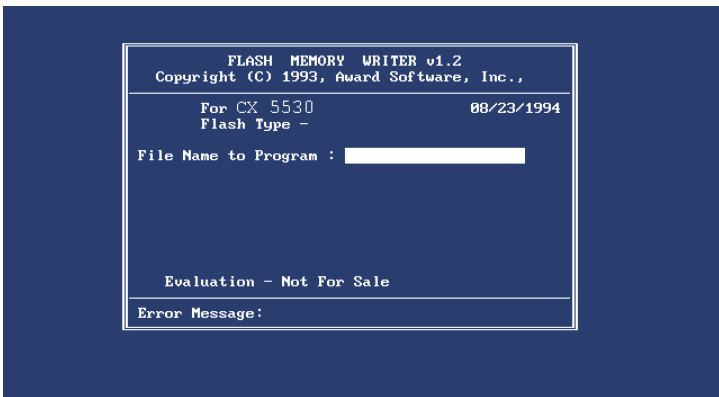

Figure 3-2: BIOS VGA setup screen

3. At the prompt, type in the BIN file which supports your display. When you are sure that you have entered the file name correctly press <Enter>. The screen will ask “Do you want to save?” If you wish to continue press Y. If you change your mind or have made a mistake press N.
4. If you decide to continue, the screen will issue a prompt which will then ask “Are you sure to program (Y/N)?” If you wish to continue, press Y. Press N to exit the program.

The new VGA configuration will then write to the ROM BIOS chip. This configuration will remain the same until you run the AWDFLASH.EXE program and change the settings.

3.4 Connections for two standard LCDs

3.4.1 Connections for Toshiba LTM10C042(640 x 480 TFT color LCD)

Table 3-1: Connections for Toshiba LTM10C042

LTM10C042		PCM-3350 Series CN 2	
Pin	Name	Pin	Name
1	GND	3	GND
2	CLK	35	SHFCLK
3	GND	4	GND
4	R0	27	PD12
5	R1	28	PD13
6	R2	29	PD14
7	GND	8	GND
8	R3	30	PD15
9	R4	31	PD16
10	R5	32	PD17
11	GND	33	GND
12	G0	19	PD6
13	G1	20	PD7
14	G2	21	PD8
15	GND	33	GND
16	G3	22	PD9
17	G4	23	PD10
18	G5	24	PD11
19	GND	34	GND
20	ENAB	37	M
21	GND	34	GND
22	B0	11	PD0
23	B1	12	PD1
24	B2	13	PD2
25	GND	39	GND
26	B3	14	PD3
27	B4	15	PD4
28	B5	16	PD5
29	GND	39	GND
30	VDD	5	+5 V
31	VDD	6	+5 V

3.4.2 Connections for Toshiba LTM12C275A (800 x 600 TFT color LCD)

Table 3-2: Connections for Toshiba LTM12C275A

LTM12C275A		PCM-3350 Series CN 2	
Pin	Name	Pin	Name
1	GND	3	GND
2	NCLK	35	SHFCLK
3	NC	-	NC
4	NC	-	NC
5	GND	4	GND
6	R0	27	PD12
7	R1	28	PD13
8	R2	29	PD14
9	R3	30	PD15
10	R4	31	PD16
11	R5	32	PD17
12	GND	8	GND
13	G0	19	PD6
14	G1	20	PD7
15	G2	21	PD8
16	G3	22	PD9
17	G4	23	PD10
18	G5	24	PD11
19	GND	33	GND
20	B0	11	PD0
21	B1	12	PD1
22	B2	13	PD2
23	B3	14	PD3
24	B4	15	PD4
25	B5	16	PD5
26	ENAB	37	M/DE
27	GND	34	GND
28	VCC	5	+5 V
29	VCC	6	+5 V
30	GND	39	GND

CHAPTER 4

Award BIOS Setup

This chapter describes how to set BIOS configuration data.

4.1 System test and initialization

These routines test and initialize board hardware. If the routines encounter an error during the tests, you will either hear a few short beeps or see an error message on the screen. There are two kinds of errors: fatal and non-fatal. The system can usually continue the boot up sequence with non-fatal errors. Non-fatal error messages usually appear on the screen along with the following instructions:

```
press <F1> to RESUME
```

Write down the message and press the F1 key to continue the bootup sequence.

4.1.1 System configuration verification

These routines check the current system configuration against the values stored in the board's CMOS memory. If they do not match, the program outputs an error message. You will then need to run the BIOS setup program to set the configuration information in memory.

There are three situations in which you will need to change the CMOS settings:

1. You are starting your system for the first time
2. You have changed the hardware attached to your system
3. The CMOS memory has lost power and the configuration information has been erased.

The PCM-3350 CMOS memory has an integral lithium battery backup. The battery backup should last ten years in normal service, but when it finally runs down, you will need to replace the complete unit.

4.2 Award BIOS setup

Award's BIOS ROM has a built-in Setup program that allows users to modify the basic system configuration. This type of information is stored in battery-backed CMOS RAM so that it retains the Setup information when the power is turned off.

4.2.1 Entering setup

Power on the computer and press immediately. This will allow you to enter Setup.

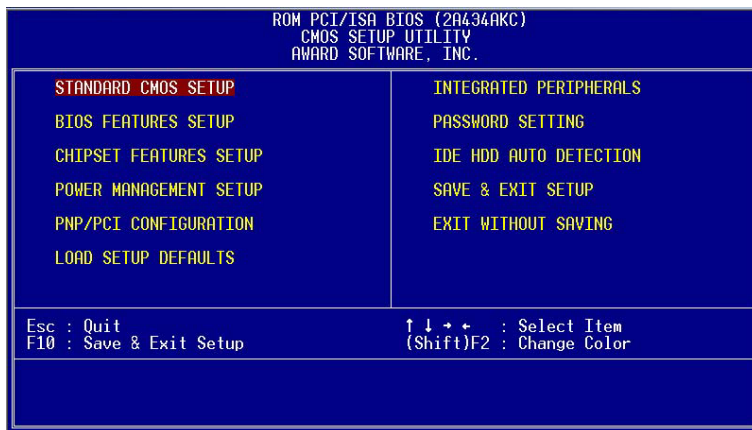

Figure 4-1: BIOS setup program initial screen

4.2.2 Standard CMOS setup

When you choose the STANDARD CMOS SETUP option from the INITIAL SETUP SCREEN menu, the screen shown below is displayed. This standard Setup Menu allows users to configure system components such as date, time, hard disk drive, floppy drive and display. Once a field is highlighted, on-line help information is displayed in the left bottom of the Menu screen.

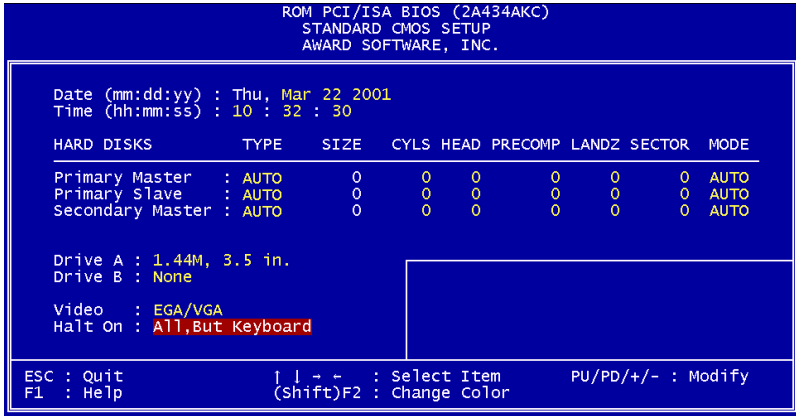

Figure 4-2: CMOS setup screen

4.2.3 BIOS features setup

By choosing the BIOS FEATURES SETUP option from the INITIAL SETUP SCREEN menu, the screen below is displayed. This sample screen contains the manufacturer's default values for the PCM-3350.

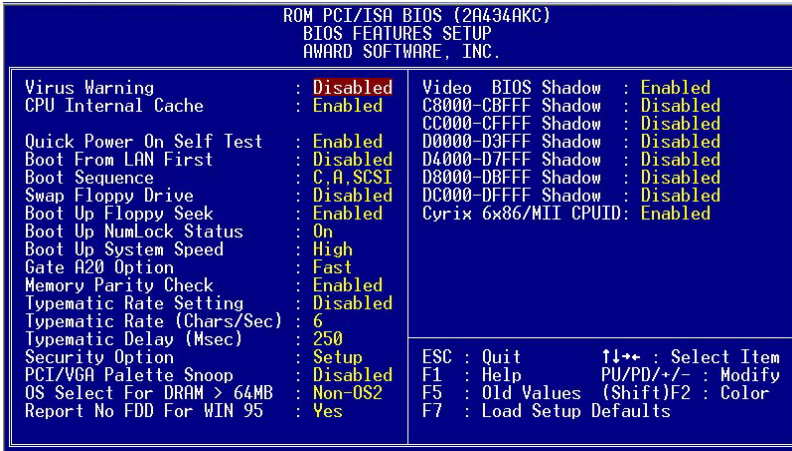

Figure 4-3: BIOS features setup

4.2.4 Chipset features setup

By choosing the CHIPSET FEATURES SETUP option from the INITIAL SETUP SCREEN menu, the screen below is displayed. This sample screen contains the manufacturer's default values for the PCM-3350.

```
ROM PCI/ISA BIOS (2A434AKC)
CHIPSET FEATURES SETUP
AWARD SOFTWARE, INC.

SDRAM CAS latency Time : 3 T
SDRAM Clock Ratio Div By : 3

16-bit I/O Recovery (CLK): 5
8-bit I/O Recovery (CLK): 5

USB Controller : Enabled
USB Legacy Support : Disabled

ESC : Quit          ||-- : Select Item
F1  : Help         PU/PD/+/- : Modify
F5  : Old Values  (Shift)F2 : Color
F7  : Load Setup Defaults
```

Figure 4-4: Chipset

4.2.5 Power management setup

By choosing the POWER MANAGEMENT SETUP option from the INITIAL SETUP SCREEN menu, the screen below is displayed.

This sample screen contains the manufacturer's default values for the PCM-3350.

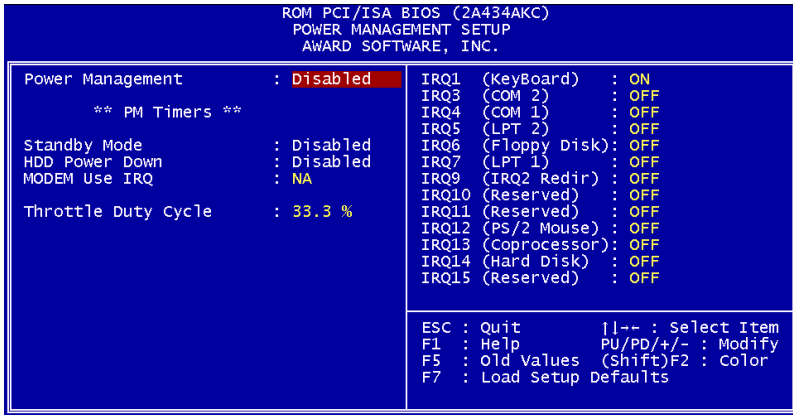

Figure 4-5: Power management setup

4.2.6 PnP/PCI configuration

By choosing the PnP/PCI CONFIGURATION option from the Initial Setup Screen menu, the screen below is displayed. This sample screen contains the manufacturer's default values for the PCM-3350.

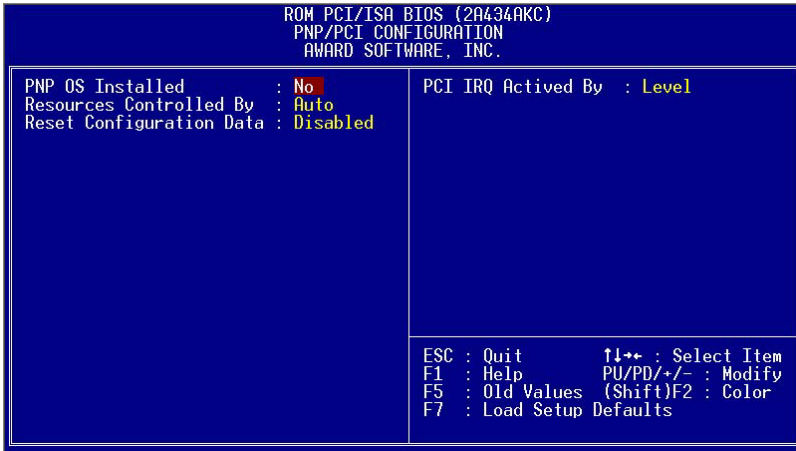

Figure 4-6: PnP/PCI configuration

4.2.7 Integrated peripherals

By choosing the INTEGRATED PERIPHERALS option from the INITIAL SETUP SCREEN menu, the screen below is displayed. This sample screen contains the manufacturer's default values for the PCM-3350. The PANEL TYPE by default supports a 18-bit 640 x 480 TFT LCD panel display.

ROM PCI/ISA BIOS (2A434AKC)			
INTEGRATED PERIPHERALS			
AWARD SOFTWARE, INC.			
IDE HDD Block Mode	: Enabled	IR IRQ Select	: IRQ11
Primary IDE Channel	: Enabled	Onboard Parallel Port	:
Master Drive PIO Mode	: Auto	Parallel Port Mode	:
Slave Drive PIO Mode	: Auto	ECP Mode Use DMA	: 3
Secondary IDE Channel	: Enabled	EPP Mode Select	: EPP1.9
Master Drive PIO Mode	: Auto	Multiple Monitor Support	: No Onboard
IDE Primary Master UDMA	: Auto	Video Memory Size	: 2.5 M
IDE Primary Slave UDMA	: Auto	Flat Panel Status	: Enabled
IDE Secondary Master UDMA	: Auto	Flat Panel Resolution	: 640x480
Onboard Speaker	: Enabled		
Onboard PCI Lan Chip	: Enabled		
KBC input clock	: 8 MHz		
Onboard FDC Controller	: Enabled		
Onboard Serial Port 1	: 3F8/IRQ4		
Onboard Serial Port 2	:		
Serial Port 2 Mode	: RS232	ESC : Quit]-- : Select Item
Onboard IR Controller	:	F1 : Help	PU/PD/+/- : Modify
IR Address Select	: 2E8H	F5 : Old Values (Shift)F2 : Color	
IR Mode	:	F7 : Load Setup Defaults	
IR Transmittiion delay	: Enabled		

Figure 4-7: Integrated peripherals

4.2.8 Change password

To change the password, choose the PASSWORD SETTING option from the Setup main menu and press <Enter>.

1. If the CMOS is bad or this option has never been used, a default password is stored in the ROM. The screen will display the following messages:

Enter Password:

Press <Enter>.

2. If the CMOS is good or this option has been used to change the default password, the user is asked for the password stored in the CMOS. The screen will display the following message:

Confirm Password:

Enter the current password and press <Enter>.

3. After pressing <Enter> (ROM password) or the current password (user-defined), you can change the password stored in the CMOS. The password can be at most eight (8) characters long.

Remember - to enable this feature, you must first select either Setup or System in the BIOS FEATURES SETUP.

4.2.9 Save & exit setup

If you select this option and press <Enter>, the values entered in the setup utilities will be recorded in the chipset's CMOS memory. The microprocessor will check this every time you turn your system on and compare this to what it finds as it checks the system. This record is required for the system to operate.

4.2.10 Exit without saving

Selecting this option and pressing <Enter> lets you exit the Setup program without recording any new values or changing old ones.

CHAPTER 5

PCI Bus Ethernet Interface

This chapter provides information on Ethernet configuration.

- Introduction
- Installation of Ethernet driver for Windows 98/NT/2000
- Further information

5.1 Introduction

The PCM-3350 is equipped with a high performance 32-bit Ethernet chipset which is fully compliant with IEEE 802.3 100 Mbps CSMA/CD standards. It is supported by major network operating systems. It is also both 100Base-T and 10Base-T compatible.

The network boot feature can be utilized by incorporating the boot ROM image files for the appropriate network operating system. The boot ROM BIOS files are combined with system BIOS, which can be enabled/disabled in the BIOS setup.

5.2 Installation of Ethernet driver

Before installing the Ethernet driver, note the procedures below. You must know which operating system you are using in your PCM-3350 Series, and then refer to the corresponding installation flow chart. Then just follow the steps described in the flow chart. You will quickly and successfully complete the installation, even if you are not familiar with instructions for MS-DOS or Windows.

Note: The windows illustrations in this chapter are examples only. You must follow the flow chart instructions and pay attention to the instructions which then appear on your screen.

5.2.2 Installation for Windows 98/2000

1. a. Select "Start", "Settings", "Control Panel".
b. Double click "Network".



2. a. Click "Add" and prepare to install network functions.

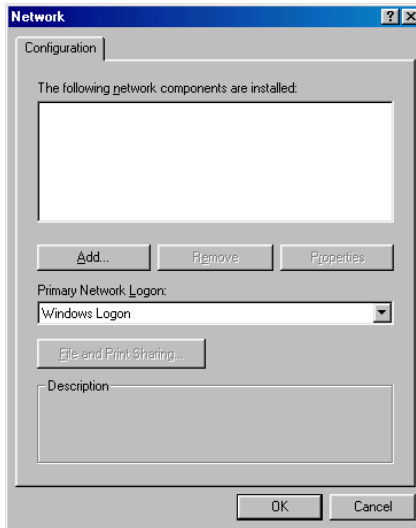

3. a. Select the "Adapter" item to add the Ethernet card.

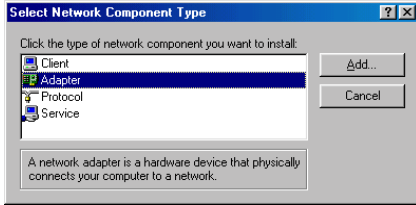

4. a. Click "Have Disk" to install the driver

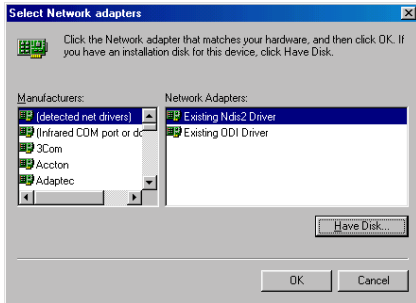

5. a. Insert the CD into the D:\drive
b. Fill in "D:\PC104\3350\LAN\82559ER\W9x&w2k"
c. Click "OK"

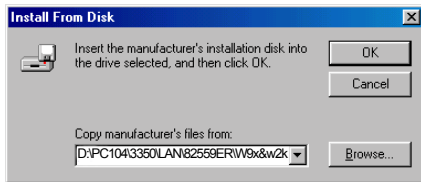

6. a. Choose the "82559ER" item.
b. Click "OK".

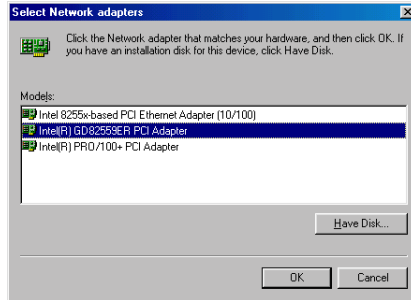

7. a. Make sure the configurations of relative items are set correctly.
b. Click "OK" to reboot.

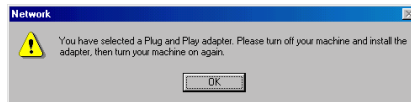

Note: *The correct path for Windows NT is:
"D:\PC104\3350\LAN\82559ER\WinNT"*

5.3 Further information

Realtek website: www.Realtek.com

Advantech websites: www.advantech.com
www.advantech.com.tw

CHAPTER 6

SVGA Setup

- Introduction
- Installation of SVGA driver for Windows 95/98/NT

6.1 Introduction

The PCM-3350 Series has an on-board LCD/VGA interface. The specifications and features are described as follows:

6.1.1 Chipset

The PCM-3350 uses an NS CS5530A chipset for its VGA controller. It supports many popular 18-bit LCD displays and conventional analog CRT monitors. The VGA BIOS supports LCD. In addition, it also supports interlaced and non-interlaced analog monitors (color and monochrome VGA) in high-resolution modes while maintaining complete IBM VGA compatibility. Digital monitors (i.e. MDA, CGA, and EGA) are NOT supported. Multiple frequency (multisync) monitors are handled as if they were analog monitors.

6.1.2 Display memory

With 1 ~ 4 MB share memory, the VGA controller can drive CRT displays or color panel displays with resolutions up to 1024 x 768 at 64 K colors. The display memory can be expanded to 4 MB in BIOS for true-color resolution of 1024 x 768.

6.2 Installation of SVGA driver

Complete the following steps to install the SVGA driver. Follow the procedures in the flow chart that apply to the operating system that you are using within your PCM-3350.

Important: The following windows illustrations are examples only. You must follow the flow chart instructions and pay attention to the instructions which then appear on your screen.

Note 1: The CD-ROM drive is designated as "D:" throughout this chapter.

Note 2: <Enter> means pressing the "Enter" key on the keyboard.

Note 3: When you are using a CRT display, please make sure that your flat panel resolution settings (in the BIOS setup) are the same as your VGA resolution settings (in Windows). Otherwise your display may behave strangely.

6.2.1 Installation for Cyrix MediaGX Certified drivers for Windows 95/98. Insert the disk into the CD-ROM drive.

1. Select "Start" then "Run".
2. Type the correct path for the driver (like the example below)
"D:\PC104\3350\VGA\Win9xc_40"
3. Click "OK"

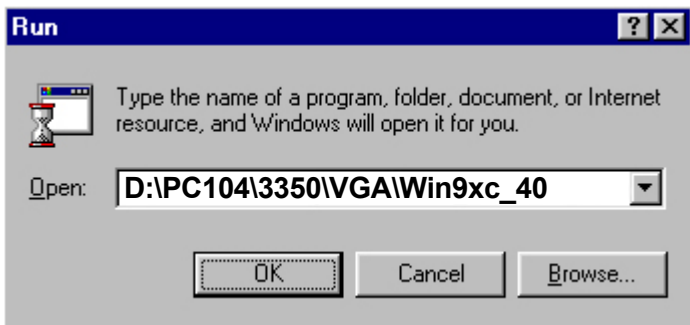

2. Click "Finish" to continue.

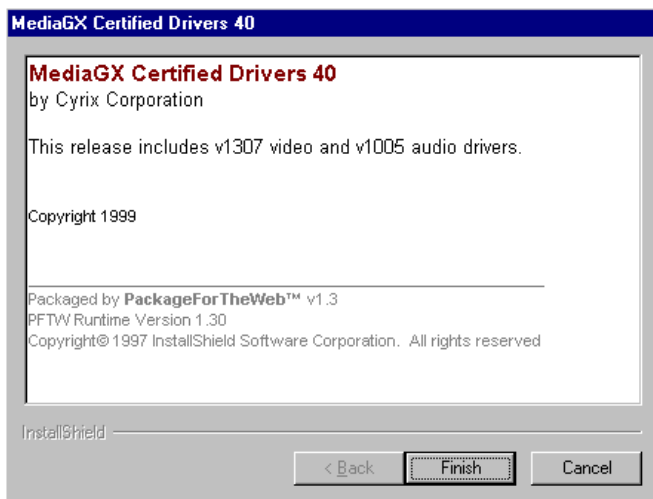

3. Click "Next" to proceed to the next step. Click "Yes" after you read the license agreement.



4. Follow the instructions which appear on the screen.



5. Insert the Win95/98 CD-ROM into the CD-ROM drive. Type the correct path for the Win9x source file.



6. Choose "Yes", then click "Finish" to restart the computer.



6.2.2 Installation for Windows NT

- Select "Start", "Settings" then "Control Panel" to get to the screen below.
 - Double click on the "Display" icon.



- Choose the "Settings" selection.
 - Click the "Display Type" button.

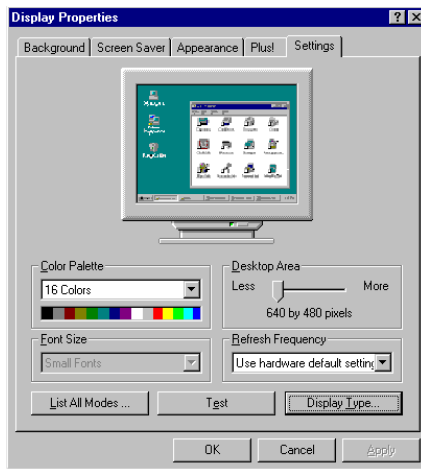

3. Press the "Change..." button.

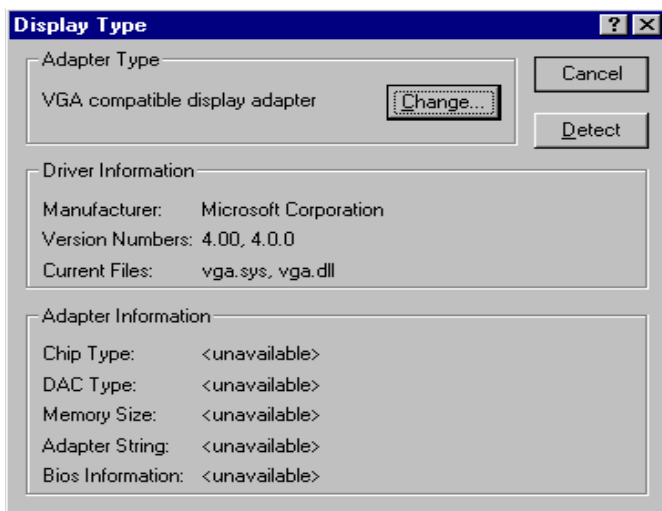

4. Click on the "Have Disk..." button

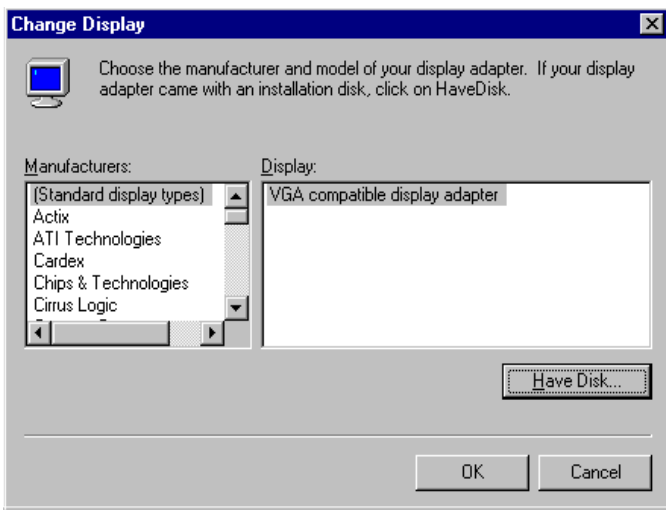

5. a. Insert the disk into the CD-ROM drive.
b. Type "D:\PC104\3350\VGA\WINNT\VGA.110"
c. Press "OK".

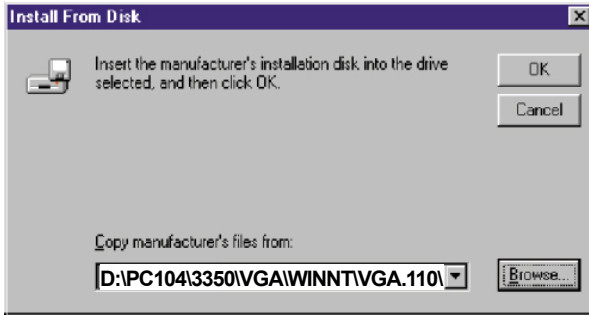

6. a. Select the highlighted item.
b. Press "OK".

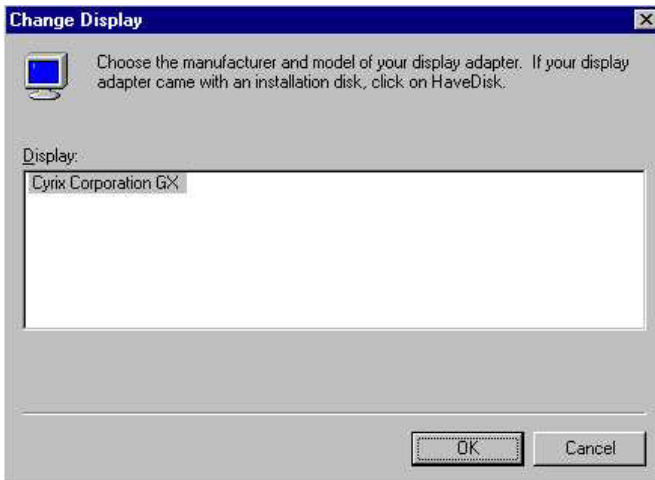

7. Press "Yes" to proceed.

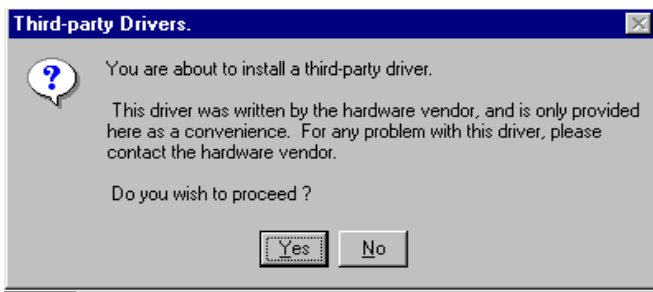

8. Press "OK" to reboot.

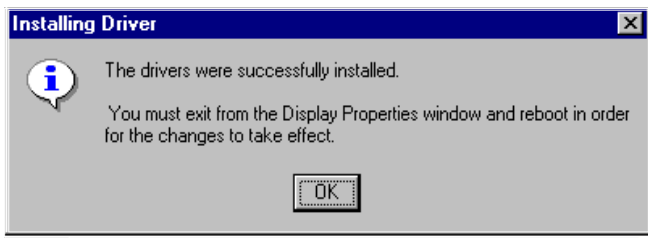

9. a. Repeat Step 1 in this manual, select the "Settings" label.
- b. Adjust the resolution and color.
- c. Click "Test" to see the results.
- d. Click "OK" to save the settings.

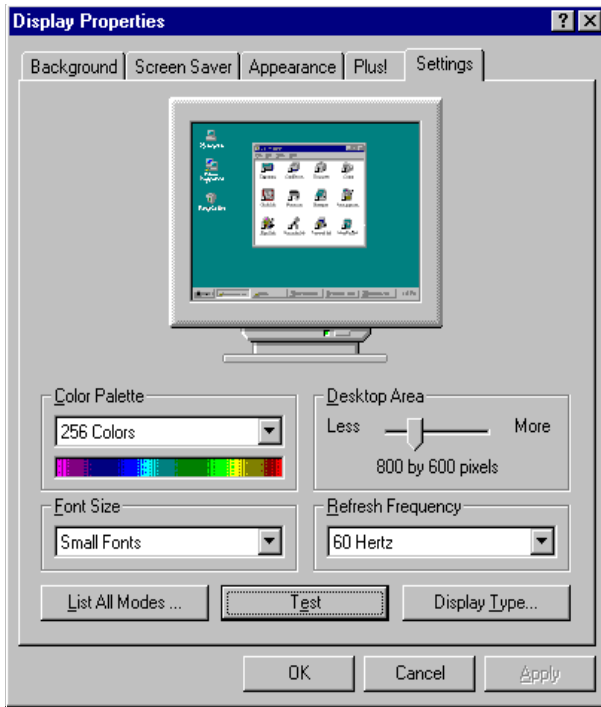

6.3 Further information

For further information about the PCI/SVGA installation in your PCM-3350, including driver updates, troubleshooting guides and FAQ lists, visit the following web resources:

Cyrix web site: **www.national.com**

Advantech web sites: **www.advantech.com**
www.advantech.com.tw

Programming the Watchdog Timer

The PCM-3350 is equipped with a watchdog timer that resets the CPU or generates an interrupt if processing comes to a standstill for any reason. This feature ensures system reliability in industrial standalone or unmanned environments.

A.1 Programming the watchdog timer

The default configuration of the timer is enabled with system reset.

To enable the watchdog timer, you must make a program which **writes 1 to I/O port address 443 (hex)** at regular intervals. The first time your program reads the port, it enables the watchdog timer. After that, your program must **write 1 to port 443** at time intervals of less than 1.6 seconds. Otherwise, the watchdog timer will activate and reset the CPU. When you want to disable the watchdog timer, your program should **write 0 to port 443**.

If CPU processing comes to a standstill because of EMI or a software problem, your program's signals to I/O port address 443 of the timer will be interrupted. The timer will then automatically reset the CPU, and data processing will continue normally.

You must make your program so that it **writes 1 to I/O port 443** at an interval shorter than the timer's preset interval. The timer's intervals have a tolerance of $\pm 30\%$, so you should program an instruction that will refresh the timer about every second.

The following example shows how you might program the watchdog timer in BASIC:

```
10      REM  Watchdog timer example program
20      X=Out &H443,1 REM  Enable and refresh the
      watchdog
30      GOSUB 1000 REM  Task #1, takes 1 second to
      complete
40      X=Out &H443,1 REM  Refresh the watchdog
50      GOSUB 2000 REM  Task #2, takes 1 second to
      complete
60      X=Out &H443,0 REM  Disable the watchdog
70      END
1000     REM  Subroutine #1, takes 1 second to complete
      .
      .
      .
1070     RETURN
2000     REM  Subroutine #2, takes 1 second to complete
      .
      .
      .
2090     RETURN
```

APPENDIX

B

Installing PC/104 Modules

This appendix gives instructions for installing PC/104 modules.

B.1 Installing PC/104 modules

The PCM-3350's PC/104 connectors give you the flexibility to attach PC/104 modules.

Installing these modules on the PCM-3350 is quick and simple. The following steps show how to mount the PC/104 modules:

1. Remove the PCM-3350 from your system paying particular attention to the safety instructions already mentioned above.
2. Make any jumper or link changes required to the CPU card now. Once the PC/104 module is mounted you may have difficulty in accessing these.
3. Normal PC/104 modules have male connectors and mount directly onto the main card. (Refer to the diagram on the following page.)
4. Mount the PC/104 module onto the CPU card by pressing the module firmly but carefully onto the mounting connectors.
5. Secure the PC/104 module onto the CPU card using the four mounting spacers and screws.

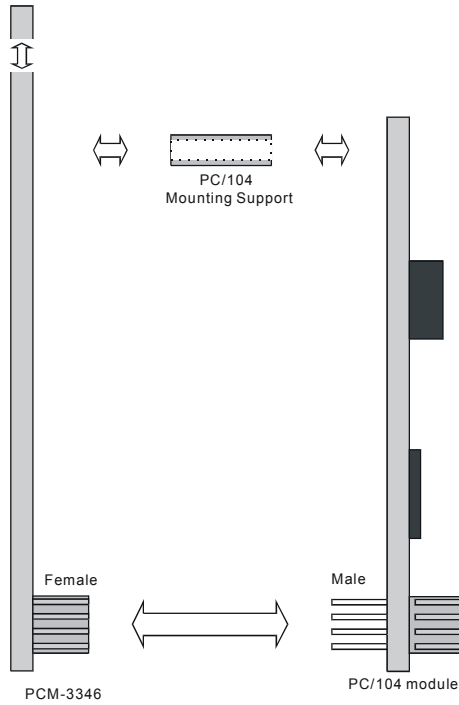

Figure B-1: PC/104 module mounting diagram

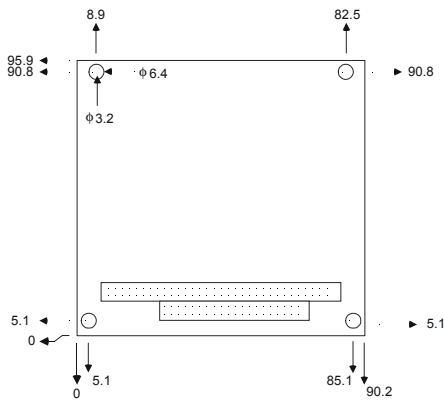

Figure B-2: PC/104 module dimensions (mm) (± 0.1)

Table B-1: PCM-3350 PC/104 connectors (CN6)

Pin Number	Signal (CN6)		Signal (CN6)	
	Row A	Row B	Row C	Row D
0	—	—	0 V	0 V
1	IOCHCHK*	0 V	SBHE*	MEMCS16*
2	SD7	RESETDRV	LA23	IOCS16*
3	SD6	+5 V	LA22	IRQ10
4	SD5	IRQ9	LA21	IRQ11
5	SD4	-5 V	LA20	IRQ12
6	SD3	DRQ2	LA19	IRQ15
7	SD2	-12 V	LA18	IRQ14
8	SD1	ENDXFR*	LA17	DACK0*
9	SD0	+12 V	MEMR*	DRQ0
10	IOCHRDY	N/C	MEMW*	DACK5*
11	AEN	SMEMW*	SD8	DRQ5
12	SA19	SMEMR*	SD9	DACK6*
13	SA18	IOW*	SD10	DRQ6
14	SA17	IOR*	SD11	DACK7*
15	SA16	DACK3*	SD12	DRQ7
16	SA15	DRQ3	SD13	+5 V
17	SA14	DACK1*	SD14	MASTER*
18	SA13	DRQ1	SD15	0 V
19	SA12	REFRESH*	KEY	0 V
20	SA11	SYSCLK	—	—
21	SA10	IRQ7	—	—
22	SA9	IRQ6	—	—
23	SA8	IRQ5	—	—
24	SA7	IRQ4	—	—
25	SA6	IRQ3	—	—
26	SA5	DACK2*	—	—
27	SA4	TC	—	—
28	SA3	BALE	—	—
29	SA2	+5 V	—	—
30	SA1	OSC	—	—
31	SA0	0 V	—	—
32	0 V	0 V	—	—

* low active

Pin Assignments

This appendix contains information of a detailed or specialized nature. It includes:

- Ethernet connector
- LCD connector
- COM1 connector
- COM2 connector
- EIDE HDD connector
- PC/104 connector
- Parallel port connector
- Backlight connector
- VGA connector
- Main power (+5 V) connector
- PS/2 keyboard/mouse connector
- FDD connector
- USB connector
- Multifunction connector
- CompactFlash™ socket

C.1 Ethernet connector (CN1)

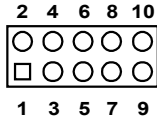

Table C-1: Ethernet connector (CN1)

Pin	Signal	Pin	Signal
1	Vcc (+5 V)	2	ACTLED-
3	RX+	4	RX-
5	LILED-	6	GND
7	NC	8	GND
9	TX+	10	TX-

C.2 LCD connector (CN2)

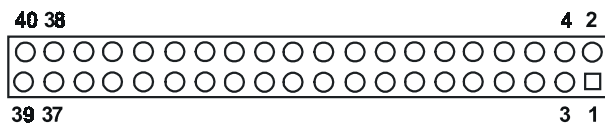

Table C-2: LCD connector (CN2)

Pin	Signal	Pin	Signal
1	VDDSAFE +5 V	2	VDDSAFE +5 V
3	GND	4	GND
5	VDDSAFE +3.3 V	6	VDDSAFE +3.3 V
7	NC	8	GND
9	P0	10	P1
11	P2	12	P3
13	P4	14	P5
15	P6	16	P7
17	P8	18	P9
19	P10	20	P11
21	P12	22	P13
23	P14	24	P15
25	P16	26	P17
27	P18	28	P19
29	P20	30	P21
31	P22	32	P23
33	GND	34	GND
35	SHIFT CLOCK	36	FLM (FIRST LINE MARKER)
37	M (DISPLAY ENABLE)	38	LP (LATCH PULSE)
39	ENABKL	40	ENAVEE

Note: The model number of the CN2 socket is DF13A-40DP-1.25V (Hirose Electric Co., Ltd.)

C.3 COM1 connector (CN3)

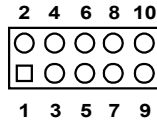

Table C-3: COM1 connector (CN3)

Pin	Signal	Pin	Signal
1	RLSD	2	DSR
3	RX	4	RTS
5	TX	6	CTS
7	DTR	8	RI
9	GND	10	NC

C.4 COM2 connector (CN4)

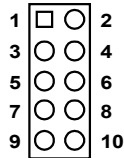
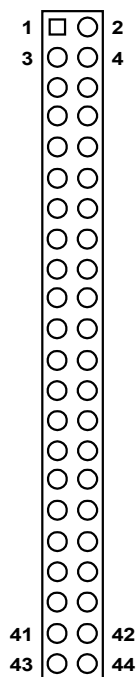

Table C-4: COM2 connector (CN4)

Pin	Signal	Pin	Signal
1	RLSD	2	DSR
3	RX	4	RTS
5	TX	6	CTS
7	DTR	8	RI
9	GND	10	NC

C.5 EIDE hard drive connector (CN5)

Table C-5: EIDE hard drive connector (CN5)



Pin	Signal	Pin	Signal
1	*RESET	2	GND
3	D7	4	D8
5	D6	6	D9
7	D5	8	D10
9	D4	10	D11
11	D3	12	D12
13	D2	14	D13
15	D1	16	D14
17	D0	18	D15
19	GND	20	NC
21	DRQ	22	GND
23	*IOW	24	GND
25	*IOR	26	GND
27	IOCHRDY	28	GND
29	*DACK	30	GND
31	IRQ	32	NC
33	SA1	34	NC
35	SA 0	36	SA2
37	*HDCS1	38	*HDCS3
39	NC	40	GND
41	Vcc	42	Vcc
43	GND	44	NC

* low active

C.6 PC/104 connector (CN6)

For details on PC/104 connectors, please refer to Appendix B.

C.7 Parallel port connector (CN7)

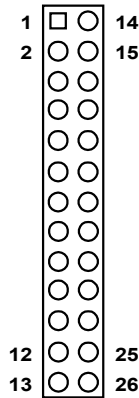

Table C-7: Parallel port connector (CN7)

Pin	Signal	Pin	Signal
1	*STROBE	14	AFD
2	PD0	15	ERROR
3	PD1	16	INIT
4	PD2	17	SLIN
5	PD3	18	GND
6	PD4	19	GND
7	PD5	20	GND
8	PD6	21	GND
9	PD7	22	GND
10	ACKNOWLEDGE	23	GND
11	BUSY	24	GND
12	PE (PAPER EMPTY)	25	GND
13	SLCT	26	N/C

* low active

C.8 Backlight connector (CN8)

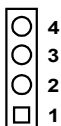

Table C-8: Backlight connector (CN8)

Pin	Signal
1	+12 V
2	GND
3	BACKLIGHT ENABLE
4	N/C

C.9 VGA connector (CN9)

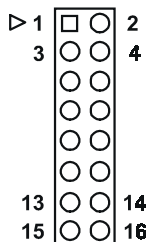

Table C-9: VGA connector (CN11)

Pin	Signal	Pin	Signal
1	RED_OUT	2	VCC_VGA
3	GREEN_OUT	4	GND
5	BLUE-OUT	6	N/C
7	N/C	8	D2C_DATA
9	GND	10	HS
11	GND	12	VS
13	GND	14	D2C_CLOCK
15	GND	16	N/C

C.10 Main power (+5 V) connector (CN11)

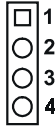

Table C-10: Main power (+5 V) connector (CN11)

Pin	Signal
1	+12 V
2	GND
3	GND
4	Vcc (+5)

C.11 PS/2 keyboard/mouse connector (CN12)

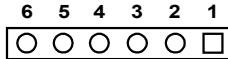

Table C-11: PS/2 keyboard/mouse connector (CN12)

Pin	Signal
1	PS/2 KB CLOCK
2	PS/2 KB DATA
3	PS/2 MOUSE CLOCK
4	GND
5	Vcc
6	PS/2 MOUSE DATA

C.12 FDD connector (CN14)

Table C-12: FDD connector (CN14)

Pin	Signal
1	Vcc (5 V)
2	INDEX
3	Vcc (5 V)
4	DRIVE SELECT 0
5	Vcc (5 V)
6	DISK CHANGE
7	NC
8	NC (READY)
9	NC (HD OUT)
10	MOTOR ON
11	NC
12	DIRECTION SELECT
13	NC (1.6 MB IN)
14	STEP
15	GND
16	WRITE DATA
17	GND
18	WRITE GATE
19	GND
20	TRACK 00
21	GND
22	WRITE PROTECT
23	GND
24	READ DATA
25	GND
26	SIDE SELECT

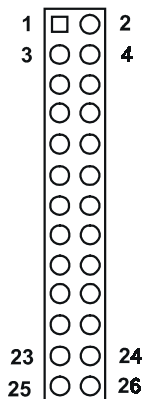

* low active

C.13 CompactFlash™ socket (CN16)

Table C-13: CompactFlash™ socket (CN16)

Pin	Signal	Pin	Signal
1	GND	2	D03
3	D04	4	D05
5	D06	6	D07
7	*CS0	8	A10
9	*ATA SEL	10	A09
11	A08	12	A07
13	+5 V	14	A06
15	A05	16	A04
17	A03	18	A02
19	A01	20	A00
21	D00	22	D01
23	D02	24	*IOCS16
25	*CD2	26	*CD1
27	D11	28	D12
29	D13	30	D14
31	D15	32	*CS1
33	*VS1	34	*IORD
35	*IOWR	36	*WE
37	INTRQ	38	+5 V
39	*CSEL	40	*VS2
41	*RESER	42	IORDY
43	*INPACK	44	*REG
45	*DASP	46	*PDIAG
47	D08	48	D09
49	D10	50	GND

* low active

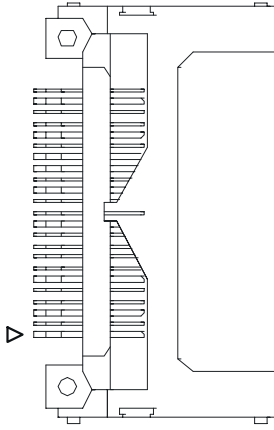

Figure C-1: CompactFlash™ socket

C.14 COM2 connector for 422/485 (CN18)

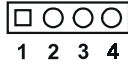

Table C-14: COM2 connector for 422/485 (CN18)

Pin	Signal
1	RXD - 485
2	RXD + 485
3	TXD + 485
4	TXD - 485

C.15 Multifunction Jumper (MJ1)

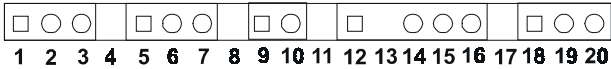

Table C-15: MJ1-A, -5 V, -12 V input

Pin	Signal
1	-5 V
2	GND
3	-12 V

Table C-16: MJ1-B, fan connector

Pin	Signal
5	+5 V
6	GND
7	+12 V

Table C-17: MJ1-C, reset button

Pin	Signal
9	*system reset
10	GND

Table C-18: MJ1-D, IR connector

Pin	Signal
12	+5 V
13	NC
14	Receive
15	GND
16	Transmit

Table C-19: MJ1-E, watchdog jumper

Pin	Signal
18	*IRQ11
19	Watchdog signal
20	*system reset

*low active

APPENDIX **D**

System Assignments

- System I/O ports
- DMA channel assignments
- Interrupt assignments
- 1st MB memory map

D.1 System I/O ports

Table D-1: System I/O ports

Addr. range (Hex)	Device
000-01F	DMA controller
020-021	Interrupt controller 1, master
022-023	Chipset address
040-05F	8254 timer
060-06F	8042 (keyboard controller)
070-07F	Real-time clock, non-maskable interrupt (NMI) mask
080-09F	DMA page register,
0A0-0BF	Interrupt controller 2
0C0-0DF	DMA controller
0F0	Clear math co-processor
0F1	Reset math co-processor
0F8-0FF	Math co-processor
170- 178	2nd fixed disk for CompactFlash
1F0-1F8	1st fixed disk
200-207	Game I/O
278-27F	Reserved
2F8-2FF	Serial port 2
300-31F	Ethernet**
360-36F	Reserved
378-37F	Parallel printer port 1 (LPT1)
380-38F	SDLC, bisynchronous 2
3A0-3AF	Bisynchronous 1
3B0-3BF	Monochrome display and printer adapter (LPT1)
3C0-3CF	Reserved
3D0-3DF	Color/graphics monitor adapter
3F0-3F7	Diskette controller
3F8-3FF	Serial port 1
443	Watchdog timer

** default setting

D.2 DMA channel assignments

Table D-2: DMA channel assignments

Channel	Function
0	Available
1	Available
2	Floppy disk (8-bit transfer)
3	Parallel**
4	Cascade for DMA controller 1
5	Available
6	Available
7	Available

** Parallel port DMA default setting: DMA 3

Parallel port DMA select: DMA 1, 3

D.3 Interrupt assignments

Table D-3: Interrupt assignments

Interrupt#	Interrupt source
NMI	Parity error detected
IRQ 0	Interval timer
IRQ 1	Keyboard
IRQ 2	Interrupt from controller 2 (cascade)
IRQ 3	Serial communication port 2
IRQ 4	Serial communication port 1
IRQ 5	Available
IRQ 6	Diskette controller (FDC)
IRQ 7	Parallel port 1 (print port)
IRQ 8	Real-time clock
IRQ 9	Reserve
IRQ 10	Available
IRQ 11	Reserved for watchdog timer
IRQ 12	PS/2 mouse
IRQ 13	INT from co-processor
IRQ 14	Preliminary IDE
IRQ 15	Secondary IDE for CompactFlash

USB and Ethernet IRQ is automatically set by the system

D.4 1st MB memory map

Table D-4: 1st MB memory map

Addr. range (Hex)	Device
F000h - FFFFh	System ROM
E000 - EFFF	Unused
CC00 - DFFF	available
C800 - CBFF	Ethernet ROM*
C000h - C7FFh	VGA BIOS
B800h - BFFFh	CGA/EGA/VGA text
B000h - B7FFh	Reserved for graphic mode usage
A000h - AFFFh	EGA/VGA graphics
0000h - 9FFFh	Base memory

* default setting

LCD Services

This appendix contains information of a detailed or specialized nature. It includes information about 18-bit TFT LCD interfaces.

E.1 LCD services

LCD screens are very popular on Advantech's CPU cards, biscuit PCs and POS series products, such as the PCA-6135/6145/6153, and PCA-6751/PCA-6751V. "Lighting" LCDs is virtually impossible without technical expertise. Advantech provides LCD lighting and integration services to assist our customers in setting up their systems. Advantech's LCD lighting guide explains how to make connections between LCD interfaces and LCD panels, as well as how to control contrast, brightness, V_{EE} source, LCD inverter and all other factors that affect the successful installation of LCD panels.

The following information details our LCD lighting services:

- a) This policy is only valid for Advantech products that include LCD support
- b) The customer should send the following LCD components for service:
 - DC-AC inverter and cable (i.e. connector with/without wires) and data sheet
 - LCD flat panel and cable (connector with/without wires) and complete data sheet
- c) Advantech will normally charge the customer a deposit. The deposit will be refunded when servicing exceeds a minimum volume
- d) The customer must sign the agreement and fax it to us prior to sending the LCD package. Advantech reserves the right to refuse service if the customer cannot provide the required documents and auxiliary parts
- e) Advantech will supply a BIOS file and connection cable to the customer upon completing the service
- f) A minimum of seven working days is required for completion of service, starting from receipt of the LCD package by Advantech

For the 18-bit TFT display support list, please contact our customer service department for more detailed information and service files. See our web site at: **<http://www.advantech.com/support>**