



**WTC6212BSI Inductive touch switch chip of twelve-channel electric capacitance
Specification (V1.5)
Fast Browsing**

Model distinction	Standard substance: WTC6212BSI Have low-consumption version of sleep mode:WTC6212BSI-L
Number of keys	4-12 keys
Technical principle	Capacitive to digital conversion technology
Key response mode	Single key mode, only one key can be operated at a time
Dimension of key sense element	Minimum 3mm ×3mm, maximum 30mm ×30mm, to be determined according to actual demand and panel thickness
Spacing of key sense element	Minimum spacing 0.5mm, to be determined according to actual demand
Shape of key sense element	Arbitrary polygon, rotundity or ellipse, either panel with hole in the middle or hollow panel (optional)
Material of key sense element	PCB copper coil, sheet metal, flat-top cylinder spring, conductive rubber, conductive ink, ITO layer of conductive glass, etc.
Requirements for PCB	Single-sided PCB and double-sided PCB
Panel material	Insulating materials, such as organic glass, ordinary glass, tempered glass, plastic, wood timber, paper, ceramics and stone
Panel thickness	0 – 20 mm
Adjustment method of key sensitivity	Key sensitivity can be adjusted by changing value of base capacitance CSEL.
Effective touch response time	Less than 100 ms
Water resistance	Watering or spraying water on the panel will not cause malfunction of keys; when flooded or with water accumulation, no abnormal response occurs by touching the panel.
RFI resistance	Effectively suppress RFI (radio frequency interference) caused when GSM cell phone is used to make a call or answer a call next to the panel or a talk proceeds next to the panel over high-power walkie-talkie.
Operating voltage range	WTC6212BSI: 3.3V-5.5V WTC6212BSI-L: 2.2V-5.5V
Operating temperature range	–40°C—+85°C
Data transmission interface	BCD interface (8421 code)
Storage temperature range	–50°C—+125C
Chip sealing mode	SSOP24(150MIL)
Typical application	Various home appliances, security equipment, communication equipment, industrial control equipment & instruments, entertainment equipment, medical equipment, sport facilities, toy,etc.



Table of Contents

1. Product Introduction.....3

 1.1. Product Overview.....3

 1.2. Technical Principle.....3

 1.3. High production efficiency.....3

 1.4. Adapt to different thickness panels.....3

 1.5. Chip Package Type.....3

2. Technical Features and Parameters.....3

 2.1. Technical Features.....3

 2.1.1. Simple Peripheral Circuits, and A Few Peripheral Components.....3

 2.1.2. Debugging-free Production and Excellent Long-time Working Stability.....4

 2.1.3. The user can use the compact keyboard of smaller spacing.....4

 2.1.4. Excellent Water Resistance.....4

 2.1.5. Excellent Electromagnetic Immunity.....4

 2.1.6. Unique Line Length Self-correction Function.....4

 2.1.7. Compliance with Industrial Application Specifications & Requirements.....5

 2.2 Technical Parameters.....5

3. Typical Application.....5

4. Definitions of WTC6212BSI Pins.....5

5. Output Display.....6

 5.1. Sequence diagram of BCD interface output.....6

 5.2. The real list of BCD output.....7

6. Peripheral Circuit and Precautions.....8

 6.1. Peripheral Circuit.....8

 6.2. Peripheral Circuit.....8

7. Sensitivity Setting.....8

 7.1. Selection of Suitable Capacitor CSEL.....8

 7.2. Area of sense element.....9

 7.3. The software fine adjustment of sensitivity.....9

 7.4. The method of sensitivity set by software.....9

 7.5. Factory setting sensitivity initial value of WTC6212BSI.....10

8. WTC6212BSI Power Supply.....10

 8.1 DC Voltage Stabilizer.....10

 8.2. Placement of Voltage Stabilizer Component.....11

 8.3. Grounding.....11

 8.4. Precautions for High Noise Condition.....11

 8.5. Power Filter.....11

 8.6. Use of +5V Power Supply of the Host.....11

9. Low-power version WTC6212BSI-L.....12

10. WTC6212BSI used capacitive sensors.....12

 10.1.The material and shape of the capacitive sensors.....12

 10.2. The area of the sense element.....13

 10.3. Connection between Capacitive Sensor and Panel.....13

 10.4. The common elastic connection methods are:.....13

 10.5. Requirements for sense element and Panel Contact Surface.....14

 10.6. The connection between the induction disc and the input pin of the induction disc of IC.....14

11. Processing of Vacant Sensor Channel.....14

12. Package Dimension Drawing of WTC6212BSI.....14



WTC6212BSI Inductive touch switch chip of twelve-channel electric capacitance

Specification (V1.5)

1. Product Introduction

1.1. Product Overview

WTC6212BSI series touch sensing IC is an integrated circuit designed to achieve human touch interface. It can replace the mechanical light touch key to realize waterproof and dustproof, seal isolation, with strong and artistic operation interface. A WTC6212BSI can achieve 4 to 12 independent keys. The user can use it flexibly according to the needs.

1.2. Technical Principle

WTC6212BSI uses the change of capacitance on the 16 bit high precision of CDC (digital capacitance transducer) IC detection induction disk (capacitance sensor) to identify the touch action of the human finger. The data of CDC output is processing by the embedded RISC CPU with efficient and reliable algorithms. Outward output BCD encoding to indicate the key action.

1.3. High production efficiency.

It is only needed to adjust one capacitor Csel that can change the sensitivity of all channels, and high production efficiency.

1.4. Adapt to different thickness panels

Through selecting the appropriate Csel capacitance value, appropriately adjusting the sense element can make WTC6212BSI to adapt the insulation panel of the different thickness of 0-20mm.

1.5. Chip Package Type

WTC6212BSI is packaged with standard 24PIN SSOP24A(150mil).

2. Technical Features and Parameters

2.1. Technical Features

2.1.1. Simple Peripheral Circuits, and A Few Peripheral Components



With independently designed special test circuit, self-calibration circuit and RISC processor integrated inside the IC, there are a few peripheral components.

2.1.2. Debugging-free Production and Excellent Long-time Working Stability

Calibration is not necessary for the system after the set value for capacitor Csel of sensitivity is determined. The system can automatically overcome the interference caused by electrostatic discharge, electromagnetic interference, temperature variation and accumulation of moisture and pollutants on the surface, and provide good precision and operation consistency in various environments, so the product can suffer long-distance transportation and be used in various environments. The unique compensation algorithm and high-strength anti-interference design can guarantee no occurrence of malfunction during long-time work of the product.

2.1.3. The user can use the compact keyboard of smaller spacing

The adjacent key suppression function can prevent the adjacent keys from the faulty action. That is when the same finger touches two or more than two keys, only the finger occupies the key which the area is largest that can make the response, and the key which the relatively small area is occupied by finger is suppressed and not making the response. If the finger occupies two or more than two keys at the same area, these keys do not make the response. The minimum clearance of the key can reach 0.5mm

2.1.4. Excellent Water Resistance

The special waterproof design is used for it. The keyboard not only can be splash proof, flood water proof, but also can be normal use after completely flooded, is different from the general induction at present which when the splashing water, flood water of key panel, it is easily getting false action and is unresponsive after waterlogging, or is occurring false action after pressing it by finger.

2.1.5. Excellent Electromagnetic Immunity

When applying to home apparatuses and ordinary application products, the user may get good immunity to radio frequency signals by using single-sided PCB, and easily resist the interference of most of radio frequency sources including GSM cell phone to the sensitive keys.

When applying to military and other special situations, it is suggested that double-sided PCB should be designed according to the layout requirements provided by us.

2.1.6. Unique Line Length Self-correction Function

It is common for the current similar products on the market that, the sensitivity largely differs according to the length of line from sensing key to IC pin. Our original line length self-correction technology can automatically correct such difference. The user can obtain almost uniform sensitivity for all keys of the whole sense element without complex adjustment.



2.1.7. Compliance with Industrial Application Specifications & Requirements

More reliable performance and wider application range is available for users.

2.2 Technical Parameters

Operating voltage: WTC6212BSI: 3.3V<Vcc<5.5V WTC6212BSI-L: 2.2V<Vcc<5.5V

Output voltage range: GND<Vout<Vcc

Sensing thickness (insulating medium): 0-20mm

Response time of effective touch: Less than 100ms

Operating temperature: -40°C—+85°C

Storage temperature: -50°C—+125°C

3. Typical Application

Be applicable to various kitchen apparatuses, audio and video devices, air conditioners, sanitary electrical apparatuses, lights and switches, security equipment, instruments, portable player, mobile phones, electronic toys and learning machines.

4. Definitions of WTC6212BSI Pins

WTC6212BSI pin configuration diagram is shown in the figure 1 below :

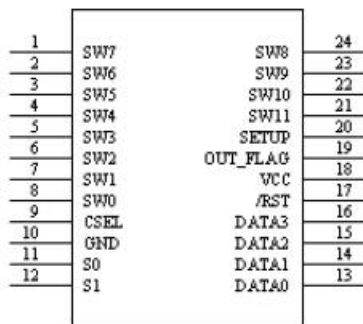

Figure 1

Table 1: the definitions of WTC6212BSI pins



Pin No.	Pin Name	Usage	Function Description
1	SW7	I	Capacitive sensor (key sense element) interface 7
2	SW6	I	Capacitive sensor (key sense element) interface 6
3	SW5	I	Capacitive sensor (key sense element) interface 5
4	SW4	I	Capacitive sensor (key sense element) interface 4
5	SW3	I	Capacitive sensor (key sense element) interface 3
6	SW2	I	Capacitive sensor (key sense element) interface 2
7	SW1	I	Capacitive sensor (key sense element) interface 1
8	SW0	I	Capacitive sensor (key sense element) interface 0
9	CSEL	I	Capacitor interface for adjusting the sensitivity
10	GND	I	Power ground
11	S0	I	The S0 must be connected to VCC usefully for the internal test foot
12	S1	I	The S1 must be connected to VCC usefully for the internal test foot
13	DATA0	I/O	BCD code output and sensitivity fine adjustment input
14	DATA1	I/O	BCD code output and sensitivity fine adjustment input
15	DATA2	I/O	BCD code output and sensitivity fine adjustment input
16	DATA3	I/O	BCD code output and sensitivity fine adjustment input
17	/RST	I	Chip reset pin
18	VCC	I	positive power supply output
19	OUT_FL AG	O	Key state indicator: 1 indicates that the key has no effective touch; 0 indicates that there is a key pressed
20	SETUP	I	The symbol of sensitivity fine adjustment input: setting 0 indicates that the sensitivity is input and set by the user; when setting 1, it indicates that IC normally performs the test work.
21	SW11	I	Capacitive sensor (key sense element) interface 11
22	SW10	I	Capacitive sensor (key sense element) interface 10
23	SW9	I	Capacitive sensor (key sense element) interface 9
24	SW8	I	Capacitive sensor (key sense element) interface 8

5. Output Display

5.1. Sequence diagram of BCD interface output

When the effective touch occurred on the induction disk is detected, the WTC6212BSI outputs the BCD code of the corresponding induction disk in 200ms, so that the user MCU can process it. The OUT_FLAG foot indicates the state of the key; 1 indicates that the key has no effective touch, and 0 indicates that it has a key pressed. The sequential relationship between the OUT_FLAG and BCD code output feet (DATA3 ~ DATA0) is shown in Figure 2

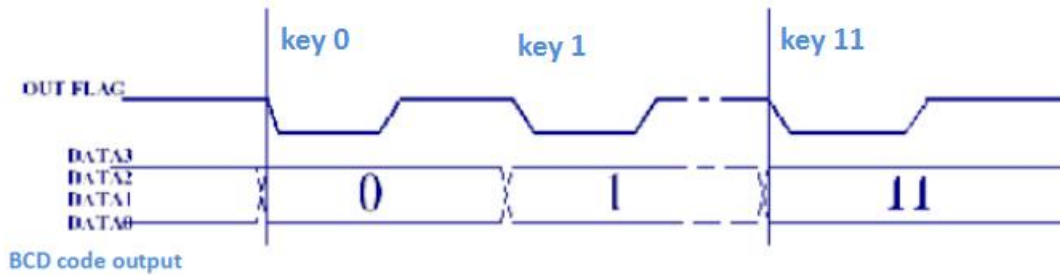

Figure 2: Sequence diagram of key output

5.2. The real list of BCD output

Output	Input	OUT_FLAG	Key value			
			DATA3	DATA2	DATA1	DATA0
	Electrifying	H	H	H	H	H
SW0	Touch	L	L	L	L	L
	Leave	H	---	---	---	---
SW1	Touch	L	L	L	L	H
	Leave	H	---	---	---	---
SW2	Touch	L	L	L	H	L
	Leave	H	---	---	---	---
SW3	Touch	L	L	L	H	H
	Leave	H	---	---	---	---
SW4	Touch	L	L	H	L	L
	Leave	H	---	---	---	---
SW5	Touch	L	L	H	L	H
	Leave	H	---	---	---	---
SW6	Touch	L	L	H	H	L
	Leave	H	---	---	---	---
SW7	Touch	L	L	H	H	H
	Leave	H	---	---	---	---
SW8	Touch	L	H	L	L	L
	Leave	H	---	---	---	---
SW9	Touch	L	H	L	L	H
	Leave	H	---	---	---	---
SW10	Touch	L	H	L	H	L
	Leave	H	---	---	---	---
SW11	Touch	L	H	L	H	H
	Leave	H	---	---	---	---

The "one" in the table indicates that after the finger leaves, before touching the next key, the electrical level of DATA0~DATA2 is kept the touch last time, and the key value of the key is unchanged.

6. Peripheral Circuit and Precautions

6.1. Peripheral Circuit

The peripheral circuit of WTC6212BSI is simple and requires only a small amount of resistance.

Figure 3 is the application circuit diagram of WTC6212BSI working under the 12 keys mode

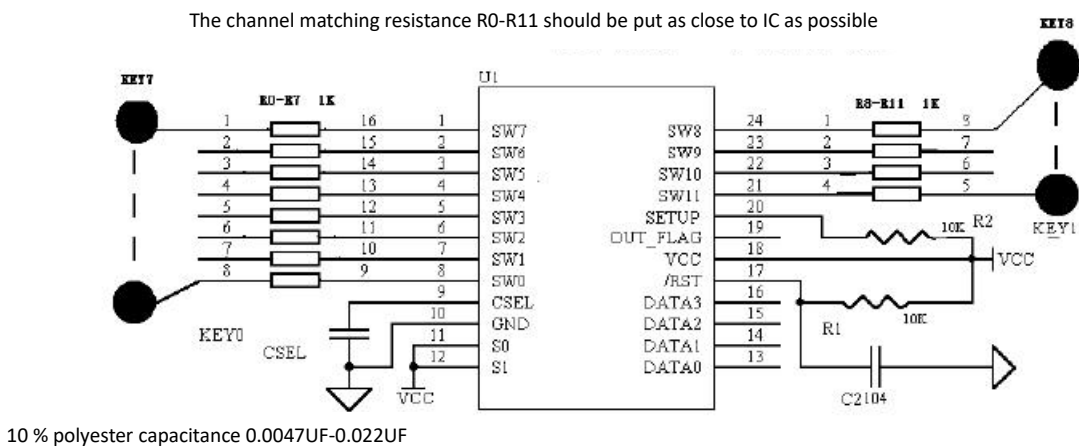

Figure 3: WTC6212BSI Application Schematic Diagram

6.2. Peripheral Circuit

The key component is capacitor CSEL for adjusting the sensitivity and 1K resistance group for measuring the matched impedance of circuit. CSEL should use 10%-precision polyester capacitor, capacitor **made of NOP material** or capacitor **made of X7R material**. 1K resistance group can provide you with the best and most stable measurement effect, and **CSEL and matched resistance shall be placed as close as possible to IC at PCB layout.**

7. Sensitivity Setting

The sensitivity setting of WTC6212BSI enables the user to use isolated media of various thicknesses to implement reliable and flexible touch function.

The sensitivity of WTC6212BSI is set by the double setting of soft and hardware.

7.1. Selection of Suitable Capacitor CSEL

The user can select the appropriate capacitance Csel according to the own use case. The larger the separation medium is, the larger the Csel capacity is. It is generally recommended to choose the appropriate capacitance between 0.0047UF and 0.022UF from large to small.

It is recommends that it is best to use the A 5 % precision polyester capacitor with a small temperature coefficient for Csel. 10 percent accuracy of polyester capacitance can also be used. If needing use of patch capacitors, 10% or higher precision NPO material or X7R capacitance needs to be used.

7.2. Area of sense element

Increasing the area of the induction disc is beneficial to improve the penetration ability of touch sensing. Increase the sensitivity.

7.3. The software fine adjustment of sensitivity

After determining the value of Csel, the software sensitivity setting can be used to make the fine adjustment, to ensure that it can achieve good results without having to make the refined adjustment to Csel.

WTC6212BSI provides level 16 software sensitivity adjustment of 15~0. The higher the level is, the more sensitive the key is.

7.4. The method of sensitivity set by software

After the user MCU has set the sensitivity series with the BCD code interface, the SETUP leg will be set low and 2MS will be maintained. After receiving the data, WTC6212BSI will set the OUT FLAG low, and send the received data from the DATA3~DATA0, so that the user MCU can confirm whether the setting is successful. After MCU confirms that the setting is success, the SETUP will be restored to high level. WTC6212BSI uses the new set sensitivity series to work.

Sequence diagram of sensitivity setting Show in Figure 4.

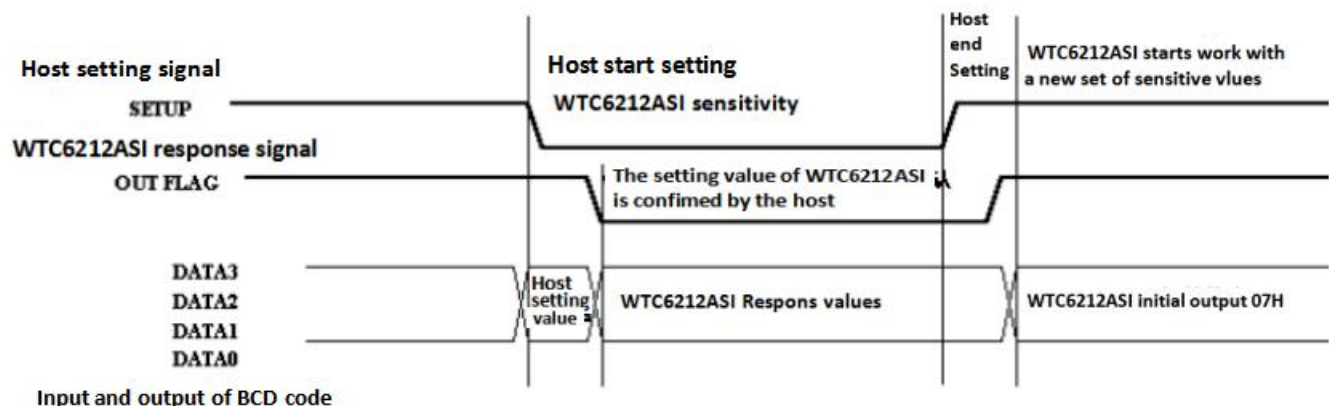

Figure 4: Sequence diagram of sensitivity setting

7.5. Factory setting sensitivity initial value of WTC6212BSI

The factory setting sensitivity initial value of WTC6212BSI is 10. The user also does not use the software sensitivity adjustment function and only uses the original factory setting and only makes the Csel adjustment.

8. WTC6212BSI Power Supply

8.1 DC Voltage Stabilizer

WTC6212BSI measures small change in capacitance, so it is required that the power ripple and noise should be small and the external strong interference involved from power supply shall be avoided. Particularly when it is applied to induction cooker and microwave oven, the external interference and voltage leap must be effectively isolated, and the power supply must have high stability. Figure 6 is the interface circuit of WTC6212BSI and 8051. It is suggested that the voltage stabilizing circuit constituted by 78L05 as shown in the figure 4 should be adopted. The capacity of C2 will affect the discharge time after power failure. The large capacity requires a longer reset time. In the circle, it is the recommended values. The different applications can be flexibly adjusted. Figure 6 is the power supply voltage circuit

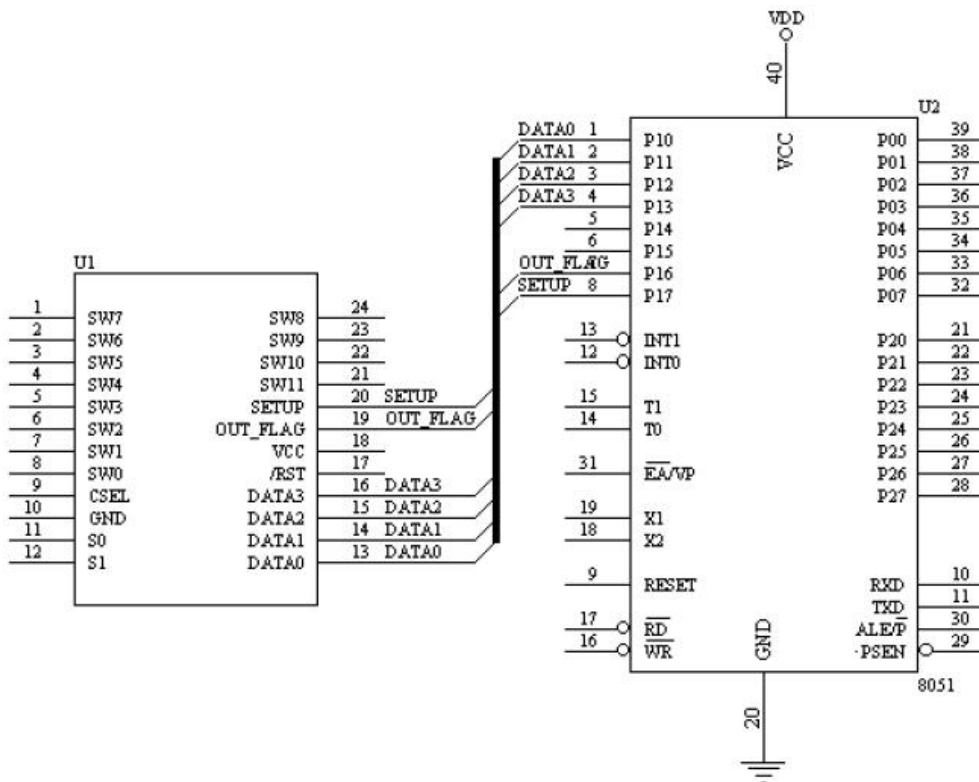

Figure 6: The interface circuit of WTC6212BSI and 8051

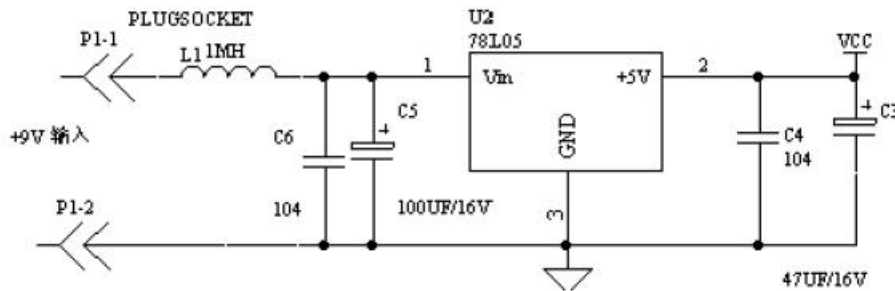

Figure 6: Voltage regulator circuit

8.2. Placement of Voltage Stabilizer Component

At PCB LAYOUT, such 78L05 power component must be close to WTC6212BSI Vcc pin.

78L05, peripheral components and WTC6212BSI must be placed on the same circuit board centrally, to put an end to the noises caused by overlong power connection line.

8.3. Grounding

The common ground of the components as shown in the figure shall be separately connected into an independent group and then it shall be connected to the common ground of the whole machine from one point of it. (Use one point of star shape to connect the ground)

8.4. Precautions for High Noise Condition

In case of application in a high-noise environment, up and down overlapped placement shall be avoided between high-voltage (220V), high-current, and high-frequency-operation main board and the touch circuit board. If such overlapped placement is unavoidable, try to keep far away from high-voltage, high-current components area or add shield on the main board.

8.5. Power Filter

When typesetting in PCB, it is recommended to reserve the inductor L1 (1MH) welding disc, but the general and the non-special applications do not need this inductance. The users can also cancel it.

When inputting 78L05 power supply, it needs to pay attention to ripple size. Please don't make the trough of ripple wave lower than DC 9V.

8.6. Use of +5V Power Supply of the Host

If the user directly uses 5V power supply of the main engine, it needs adding the power supply filter circuit in the front of the power supply of the modules or sensing power chips as shown in the figure. The requirement for PCB layout is the same as the above circuit

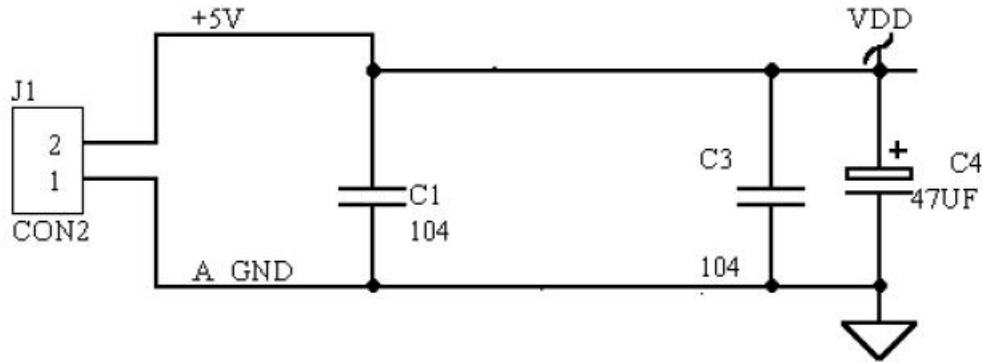

The analog and digital powers of circuit shall be connected separately to the ground in Y-connection method.

The capacitors shall be arranged in the sequence indicated in the schematic diagram and shall not be arranged arbitrarily.

Figure 7: Power Filter Circuit

Precautions:

The above circuit should connect the 104 capacitors and electrolytic capacitors of the filter circuit according to the order in the chart, and 104 capacitors should be in front of the electrolytic capacitance that can better suppresses the high frequency noise.

9. Low-power version WTC6212BSI-L

Under the situation that the touch button has not been touched in 38 seconds, the WTC6212BSI-L will automatically enter the sleep mode. During hibernation, the chip will continue to detect the input channels of each key. Once there is key being operated, the chip will be awakened and go into normal working mode. During hibernation, the static current is lower than 18uA. This low-power version chip WTC6212BSI-L can satisfy the design requirement of touch sensitive key on the electronic product of the battery power supply.

10. WTC6212BSI used capacitive sensors

10.1.The material and shape of the capacitive sensors

The capacitive sensors can be any type of conductor, but certain flat surface should be ensured. It is recommended to use a round metal sheet or other conductor with a diameter greater than 10mm. The commonly used induction disks are copper foil, spring, thin film line and ITO glass, etc. on the PCB plate etc.

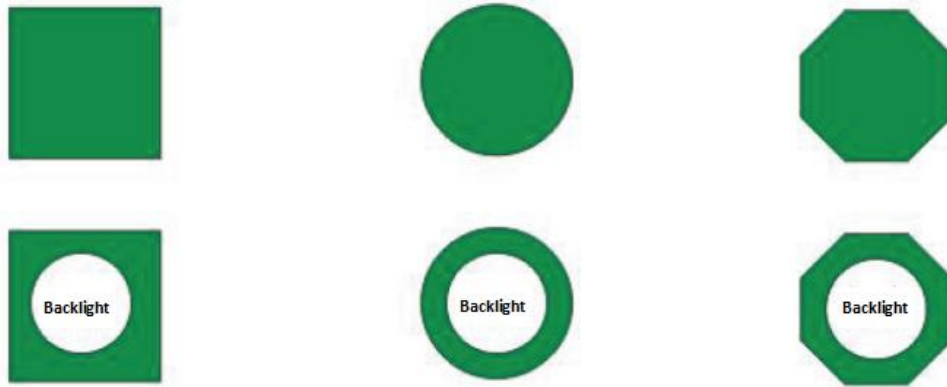

The key sense element can be solid or hollow rectangle, circle or polygon.

Figure 8: PCB Copper Foil sense element

10.2. The area of the sense element

Under the general condition, the area of the induction disk can be between 3mmX3mm~30mmX30mm, and the area of each induction disk should be kept the same, to ensure the same sensitivity.

10.3. Connection between Capacitive Sensor and Panel

The capacitive sensor shall cling to glass and other insulated panel, and elastic connection shall apply between them.

10.4. The common elastic connection methods are:

The common elastic connection methods are:

Use the sense element with spring

Use cylindrical conductive rubber to conduct elastic connection

Paste the sense element onto the panel with imported super double-sided glue, and the double-sided glue layer cannot be too thick.



Figure 9: Spring sense element



10.5. Requirements for sense element and Panel Contact Surface

The surface of the induction plate must be levelled off, and is no clearance between the panels, If the contact surface is not able to implement the sealing adhesive, the Conductive silicone grease and other gel sealing are needed to be used for it, to ensure that the junction surface with the panel is no air gap.

10.6. The connection between the induction disc and the input pin of the induction disc of IC

The connection between the capacitance sensor and the pins of WTC6212BSI should be short and thin as far as possible (0.1~0.3mm width). It is best that WTC6212BSI can be placed on the keypad and that the back and around 0.5 mm of the connection is not placed other circuit, to ensure that the sensor has good sensitivity and to avoid false triggering.

11. Processing of Vacant Sensor Channel

WTC6212BSI at least must use four touch keys, to ensure the steady operation of the chip. When it applies to the situation of less than 12 keys, SW11~SW0 will have the empty unused sensor input channel. The empty input channel only needs a simple suspending in midair, and the empty input channel cannot be added any pull-up or pull-down resistance.

If the user must use four or less sensitive keys, please be sure to contact us for the corresponding technical support.

12. Package Dimension Drawing of WTC6212BSI

Symbol	Dimensions in mil		
	Min.	Nom.	Max.
A	228	—	244
B	150	—	157
C	8	—	12
C'	335	—	346
D	54	—	60
E	—	25	—
F	4	—	10
G	22	—	28
H	7	—	10
α	0°	—	8°

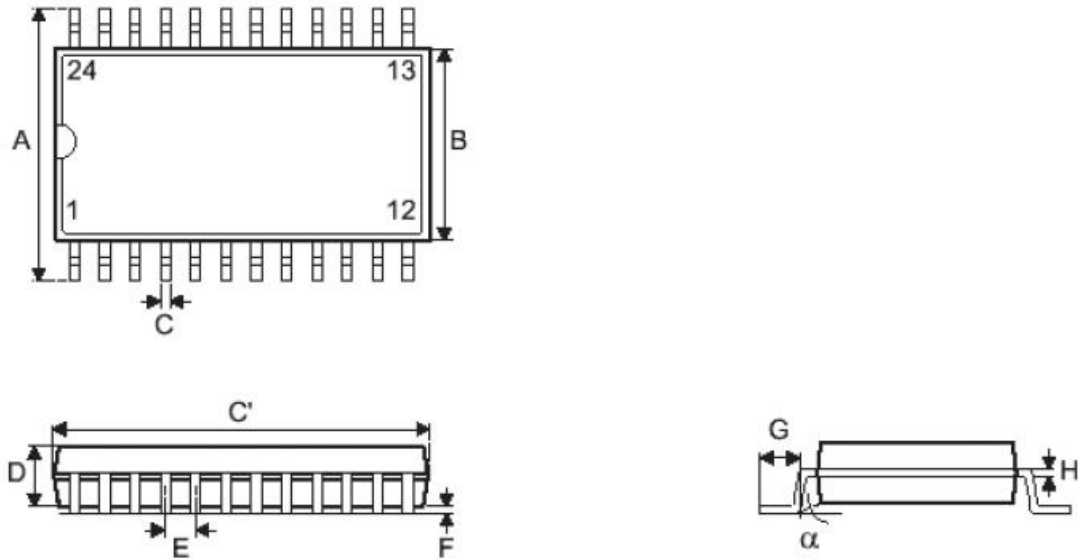

Figure 10: Package Dimension Drawing of WTC6212BSI