

μA7392 DC Motor Speed Control Circuit

Linear Division Special Functions

Description

The μA7392 is designed for precision, closed loop, motor speed control systems. It regulates the speed of capstan drive motors in automotive and portable tape players and is useful in a variety of industrial and military control applications, e.g., floppy disc drive systems and data cartridge drive systems. The device is constructed using the Fairchild Planar Epitaxial process.

The μA7392 compares actual motor speed to an externally presettable reference voltage. The motor speed is determined by frequency to voltage conversion of the input signal provided by the tachometer generator. The result of the comparison controls the duty cycle of the pulse width modulated switching motor drive output stage to close the system's negative feedback loop.

Thermal and over voltage shutdown are included for self-protection, and a stall-timer feature allows the motor to be protected from burn out during extended mechanical jams.

- Precision Performance
- High Current Performance
- Wide Range Tachometer Input
- Thermal Shutdown, Over Voltage And Stall Protection
- Internal Regulator
- Wide Supply Voltage Range 6.3 V To 16 V

Absolute Maximum Ratings

Storage Temperature Range	
Ceramic DIP	-65°C to +175°C
Molded DIP	-65°C to +150°C
Operating Temperature Range	
	-40°C to +85°C
Lead Temperature	
Ceramic DIP (soldering, 60 s)	300°C
Molded DIP (soldering, 10 s)	265°C
Internal Power Dissipation ¹⁻³	
14L-Ceramic DIP	1.36 W
14L-Molded DIP	1.04 W
Supply Voltage (V+), V ₉ , V ₁₀ , V ₁₁	
	24 V
Regulator Output Current, I ₈	
	15 mA
Voltage Applied to Lead 6 (Tachometer Pulse Timing)	
	7.0 V

Connection Diagram 14-Lead DIP (Top View)

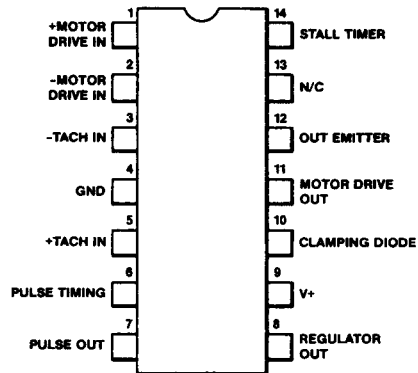

CD01290F

Order Information

Device Code	Package Code	Package Description
μA7392DV	6A	Ceramic DIP
μA7392PV	9A	Molded DIP

Voltage Applied Between Leads 3 and 5 (Tachometer Inputs)	±6.0 V
Continuous Current through Leads 11 and 12 (Motor Drive Output ON)	0.3 A
Repetitive Surge Current through Leads 11 and 12 (Motor Drive ON)	1.0 A
Repetitive Surge Current through Leads 10 and 11 (Motor Drive OFF)	0.3 A

Notes

1. T_{J Max} = 150°C for the Molded DIP, and 175°C for the Ceramic DIP.
2. Ratings apply to ambient temperature at 25°C. Above this temperature, derate the 14L-Ceramic DIP at 9.1 mW/°C, the 14L-Molded DIP at 8.3 mW/°C.
3. Internally Limited.

Block Diagram

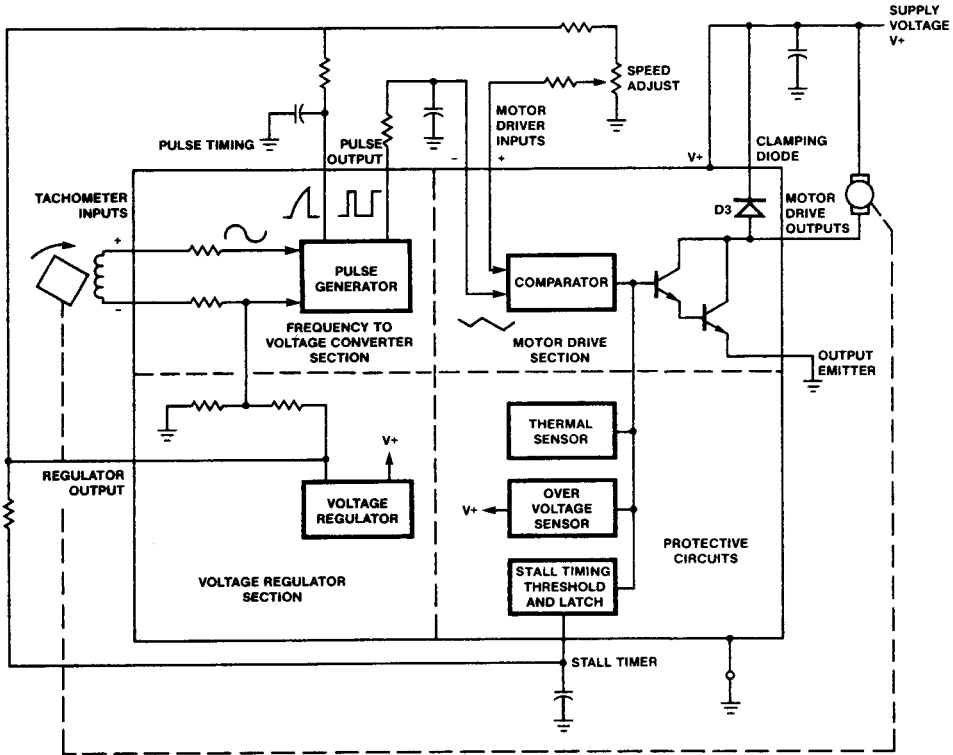

EO00540F

μA7392

Electrical Characteristics $T_A = 25^\circ\text{C}$, $V_+ = 14.5\text{ V}$, unless otherwise specified.

Symbol	Characteristic	Condition	Min	Typ	Max	Unit
Voltage Regulator Section (Test Circuit 1)						
I_{CC}	Supply Current	Excluding Current into Lead 11		7.5	10	mA
V_{Reg}	Regulator Output Voltage		4.5	5.0	5.5	V
$LINE_{Reg}$	Regulator Output Line Regulation (ΔV_B)	$V_+ = 10\text{ V to }16\text{ V}$		6.0	20	mV
		$V_+ = 6.3\text{ V to }16\text{ V}$		12	50	
$LOAD_{Reg}$	Regulator Output Load Regulation (ΔV_B)	I_B from 10 mA to 0		40		mV
Frequency to Voltage Converter Section (Test Circuit 2)						
V_{IN}	Tachometer (-) Input Bias Voltage			2.4		V
I_{IN}	Tachometer (+) Input Bias Current	$V_5 = V_3$		1.0	10	μA
V_{DIFF}	Tachometer Input Positive Threshold	$(V_5 - V_3)$	10	25	50	mV _{p-p}
V_{HY}	Tachometer Input Hysteresis		20	50	100	mV _{p-p}
R	Pulse Timing ON Resistance	$V_6 = 1.0\text{ V}$		300	500	Ω
V_{TH}	Pulse Timing Switch Threshold		45	50	55	% V_B
t_r	Output Pulse Rise Time			0.3		μs
t_f	Output Pulse Fall Time			0.1		μs
$V_{Sat-LOW}$	Pulse Output LOW Saturation (V_7)			0.13	0.25	V
V_{Sat-HI}	Pulse Output HIGH Saturation ($V_8 - V_7$)			0.12	0.2	V
I_{Source}	Pulse Output HIGH Source Current	$V_7 = 1.0\text{ V}$	-340	-260	-180	μA
SVS	Frequency-to-Voltage Conversion Supply Voltage Stability ¹	$V_{FV} = 0.25 V_8^2$ $V_+ = 10\text{ V to }16\text{ V}$		0.1		%
TS	Frequency-to-Voltage Conversion Temperature Stability ³	$V_{FV} = 0.25 V_8^2$ $T_A = -40^\circ\text{C to }+85^\circ\text{C}$		0.3		%
Motor Drive Section						
V_{IO}	Input Offset Voltage				20	mV
I_{IB}	Input Bias Current			0.1	10	μA
CMR	Common Mode Range		0.8		2.5	V
V_{SAT}	Motor Drive Output Saturation	$I_{11} = 300\text{ mA}$		1.3	2.0	V
I_{LEAK}	Motor Drive Output Leakage	$V_{11} = V_{10} = 16\text{ V}$			5.0	μA
I_D	Flyback Diode Leakage	$V_{10} = 16\text{ V}, V_{11} = 0\text{ V}$			30	μA

μA7392 (Cont.)

Electrical Characteristics T_A = 25°C, V₊ = 14.5 V, unless otherwise specified.

Symbol	Characteristic	Condition	Min	Typ	Max	Unit
V _D	Flyback Diode Clamp Voltage	I ₁₁ = 300 mA Motor Drive Output OFF		1.1	1.3	V

Protective Circuits

J-T°C	Thermal Shutdown Junction Temperature ⁴			160		°C
Over Voltage	Overvoltage Shutdown ⁴		18	21	24	V
V _{TH}	Stall Timer Threshold Voltage ⁵		2.5	2.9	3.5	V
I _{TH}	Stall Timer Threshold Current ⁵			0.3	3.0	μA

Notes

1. Frequency-to-voltage conversion, supply voltage stability is defined as:

$$\frac{V_{FV}(16\text{ V})}{V_g(16\text{ V})} - \frac{V_{FV}(10\text{ V})}{V_g(10\text{ V})} \div \frac{V_{FV}(14.5\text{ V})}{V_g(14.5\text{ V})} \times 100\%$$

2. V_{FV} is the integrated DC output voltage from the pulse generator (Lead 7)

3. Frequency-to-voltage conversion temperature stability is defined as:

$$\frac{V_{FV}(85^\circ\text{C})}{V_g(85^\circ\text{C})} - \frac{V_{FV}(-40^\circ\text{C})}{V_g(-40^\circ\text{C})} \div \frac{V_{FV}(25^\circ\text{C})}{V_g(25^\circ\text{C})} \times 100\%$$

4. Motor Drive circuitry is disabled when these limits are exceeded. If the condition continues for the duration set by the external stall timer components, the circuit is latched off until reset by temporarily opening the power supply input line.
5. If stall timer protection is not required, lead 14 should be grounded.

Typical Performance Curves

Overvoltage Shutdown Voltage vs Junction Temperature

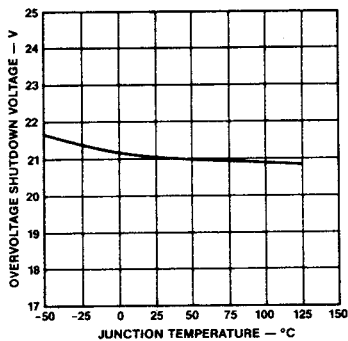

PC08340F

Stall Timer Threshold Voltage vs Junction Temperature

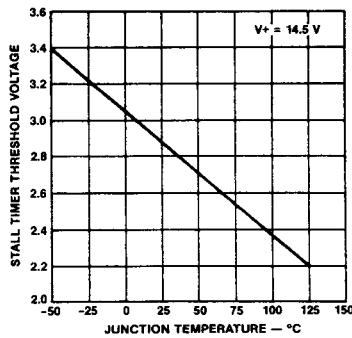

PC08350F

Stall Timer Threshold Current vs Junction Temperature

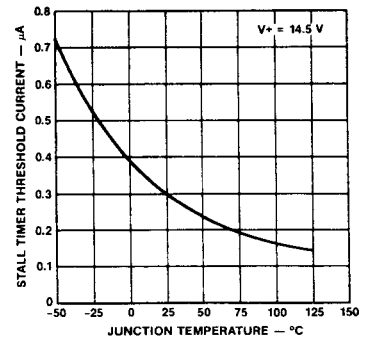

PC08360F

Typical Performance Curves (Cont.)

Supply Current vs Supply Voltage

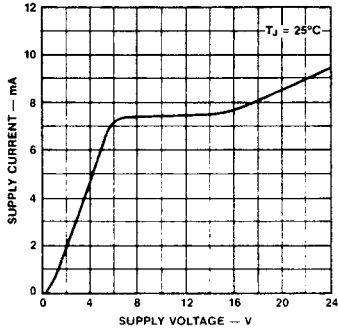

PC06370F

Regulator Output Voltage vs Supply Voltage

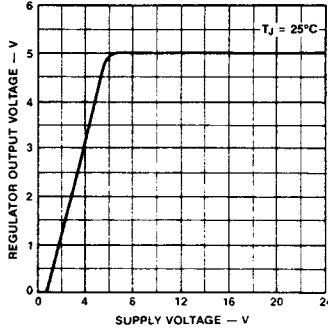

PC06380F

Regulator Output Voltage vs Junction Temperature

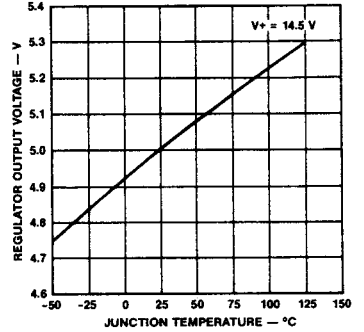

PC06390F

Tachometer Input Hysteresis vs Junction Temperature

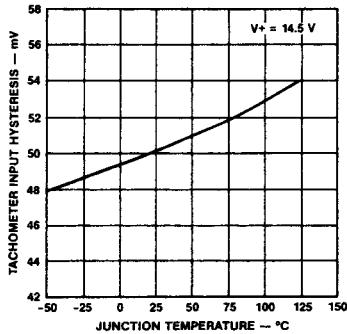

PC08400F

Flyback Diode Current (D3) vs Flyback Diode Voltage

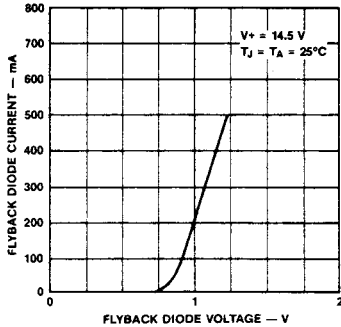

PC08410F

Motor Drive Output ON Current vs Motor Drive Output ON Voltage

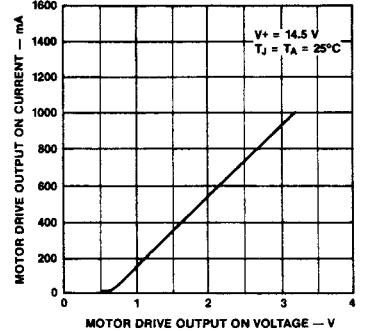

PC08420F

Motor Drive Output ON Voltage vs Ambient Temperature

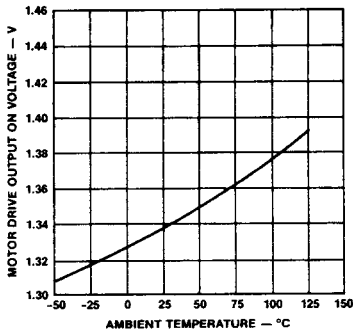

PC08430F

Test Circuits

Test Circuit 1

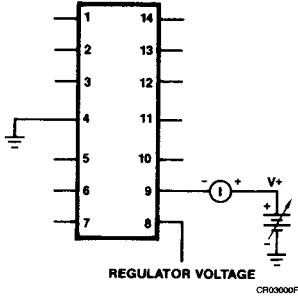

Test Circuit 2

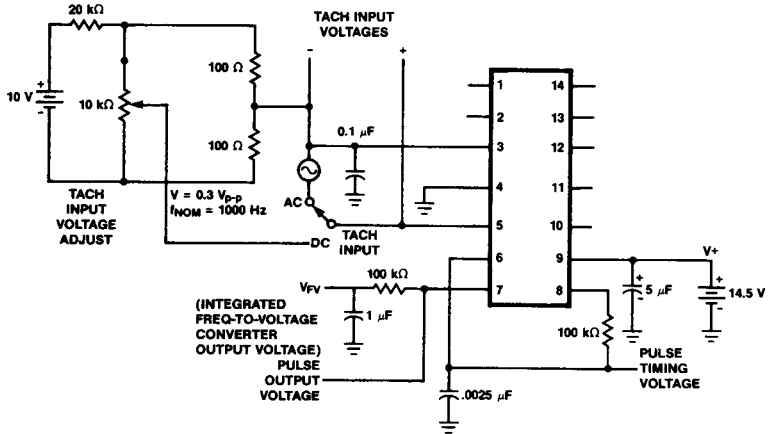

Typical Application Using Magnetic Tachometer

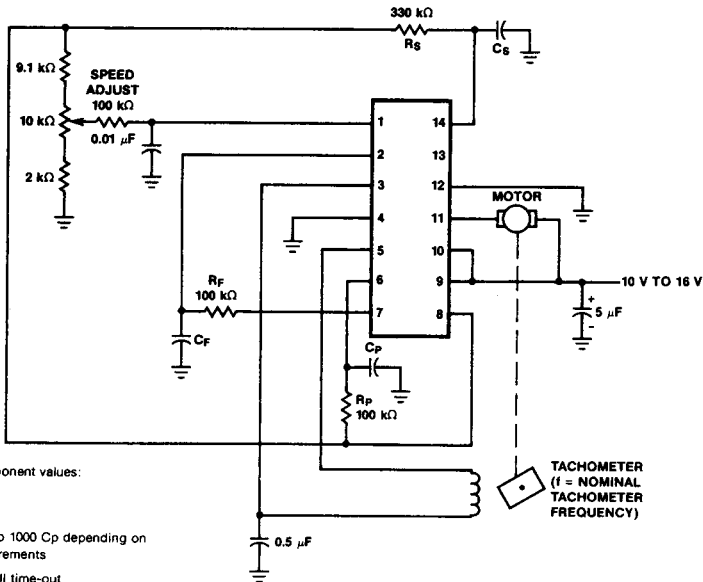

Typical component values:

$$C_p = \frac{1}{4 R_{PF}}$$

$C_F = 10 C_p$ to 1000 C_p depending on system requirements

$$C_S = \frac{2 \times \text{stall time-out}}{R_S}$$

$$R_{Motor} \geq 5 \Omega$$

CR03020F