

Features

- Wide Input Voltage Range 4.5V to 52V
- 52V / 0.9Ω Internal Power MOSFET
- 600mA Peak Output Current
- Up to 90% Efficiency
- 1.25MHz (HT7463A) and 550kHz (HT7463B) Fixed Operating Frequency
- Ultra Low Shutdown Current < 1μA
- Output Short Circuit Protection
- Thermal Shutdown Protection
- Package Type: 6-pin SOT23

General Description

The HT7463A/B is a current mode buck converter. With a wide input range from 4.5V to 52V, the HT7463A/B is suitable for a wide range of applications such as power conditioning from unregulated sources. Having a low internal switch typical RDSON value of 0.9Ω, the device has a good operating typical efficiency value of 85% and the added advantage of reduced junction temperature. The operating frequency is fixed at 1250/550kHz for the HT7463A/HT7463B respectively. The HT7463A allows the use of small external components while still being able to have low output voltage ripple.

Applications

- Power Meters
- Distribution Power Systems
- Battery Chargers
- Pre-Regulator for Linear Regulators

Application Circuit

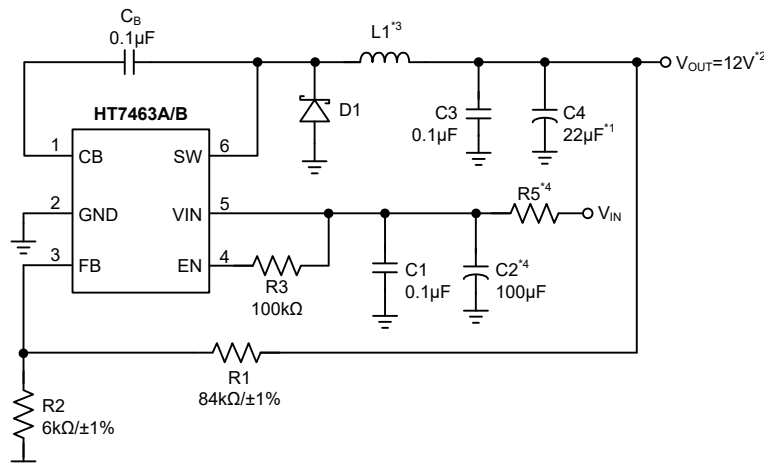

Note: *1. C4=330μF is recommended to achieve 1% output ripple requirement.

*2. Set R1=84kΩ and R2=6kΩ for VOUT =12V application.

*3. Typically recommended that L1=22μH for HT7463A and L1=47μH for HT7463B. Electromagnetic interference situation suggest L1=100μH or more.

*4. R5 and C2 values can refer to the Input Voltage Rising Time.

Block Diagram

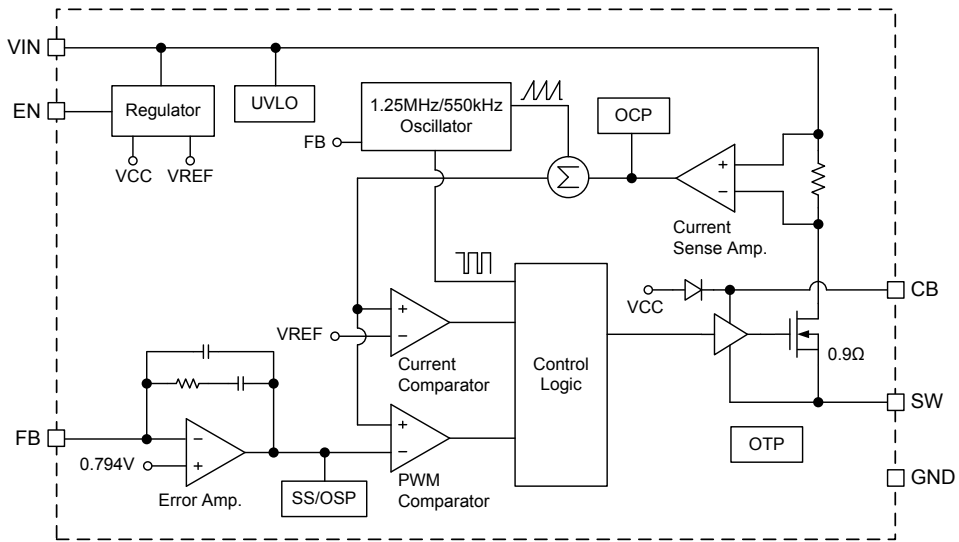

Pin Assignment

SOT23-6

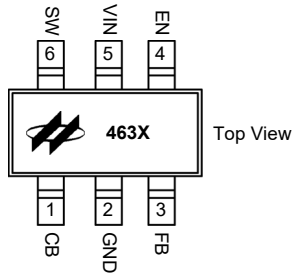

X means A(1.25MHz)/or B(550kHz)

Pin Description

Pin Order	Name	Type	Pin Description
1	CB	I/O	SW FET gate bias voltage. Connect the boot capacitor between CB and SW
2	GND	G	Ground terminal
3	FB	I	Feedback pin: Set feedback voltage divider ratio with $V_{OUT} = V_{FB} (1+(R1/R2))$
4	EN	I	EN pin should be connected to VIN pin by a resistor
5	VIN	P	Power supply
6	SW	O	Power FET output

Absolute Maximum Ratings

Parameter	Value	Unit
VIN and SW	-0.3 to +55	V
EN	-0.3 to (VIN+0.3)	V
CB above SW voltage	+5.5	V
FB	-0.3 to +5.0	V
Operating Temperature Range	-40 to +85	°C
Maximum Junction Temperature	+150	°C
Storage Temperature Range	-60 to +150	°C
Lead Temperature (Soldering 10sec)	+300	°C
ESD Susceptibility	Human Body Model	2000
	Machine Model	200
Junction-to-Ambient Thermal Resistance, θ_{JA}	220	°C/W
Junction-to-Case Thermal Resistance, θ_{JC}	110	°C/W

Recommended Operating Range

Parameter	Value	Unit
VIN	4.5 to 52	V
SW and EN	Up to 52	V

Note that Absolute Maximum Ratings indicate limitations beyond which damage to the device may occur. Recommended Operating Ratings indicate conditions for which the device is intended to be functional, but do not guarantee specified performance limits.

Electrical Characteristics

 $V_{IN}=12V$ and $T_a=+25^{\circ}C$, unless otherwise specified

Symbol	Parameter	Test Condition	Min	Typ	Max	Unit
Supply Voltage						
V_{IN}	Input Voltage	V_{IN}	4.5	—	52	V
I_{CC}	Quiescent Current	$V_{EN}=2.5V, V_{FB}=1V$	—	0.7	1	mA
I_{OFF}	Shutdown Current	$V_{EN}=0V$	—	0.1	1	μA
Buck Converter						
V_{OUT}	Output Voltage ^(Note)	—	1.0	—	$0.9 \times V_{IN}$	V
f_{SW}	Switching Frequency	HT7463A, $V_{FB}=0.6V$	1000	1250	1500	kHz
		HT7463B, $V_{FB}=0.6V$	440	550	660	kHz
F_{FB}	Fold-back Frequency	HT7463A, $V_{FB}=0V$	90	105	—	kHz
		HT7463B, $V_{FB}=0V$	90	105	—	kHz
D_{MAX}	Maximum Duty Cycle	HT7463A	—	90	—	%
		HT7463B	—	95	—	%
$T_{ON(min)}$	Minimum ON-Time	—	—	100	—	ns
$R_{DS(on)}$	Switch-ON Resistance	$V_{EN}=2.5V$	—	0.9	—	Ω
$I_{SW(off)}$	SW Leakage Current	$V_{EN}=0V, V_{SW}=0V, V_{IN}=52V$	—	0.1	1	μA
V_{FB}	Feedback Voltage	$4.5V \leq V_{IN} \leq 52V$	0.778	0.794	0.81	V
$I_{FB(leak)}$	Feedback Leakage Current	$V_{FB}=3V$	—	—	0.1	μA
I_{EN}	EN Input Current	$V_{EN}=0V$	—	0.1	—	μA
		$V_{EN}=52V$	—	16	—	μA
V_{IH}	EN High Voltage Threshold	$4.5V \leq V_{IN} \leq 52V$	2.3	—	—	V
V_{IL}	EN Low Voltage Threshold	$4.5V \leq V_{IN} \leq 52V$	—	—	0.9	V
Protections						
V_{UVLO+}	Input Supply Turn ON Level	UVLO+	—	—	4.2	V
V_{UVLO-}	Input Supply Turn OFF Level	UVLO-	3.4	—	—	V
I_{OCP}	Over Current Protection Threshold	—	—	1	—	A
T_{SHD}	Thermal Shutdown Threshold	OTP	—	150	—	$^{\circ}C$
T_{REC}	Thermal Recovery Temperature	—	—	125	—	$^{\circ}C$

Note: 1. MIN Output Voltage is restricted by Minimum ON-Time, 100ns.

2. MAX Output Voltage is restricted by Maximum Duty Cycle and Switch-ON Resistance.

3. The selection use of the HT7463A/HT7463B can refer to the Recommended Operating Area.

Typical Performance Characteristics

$V_{IN}=18V$, $V_{OUT}=12.5V$, $L=15/22\mu H$ for HT7463A and $L=33/47\mu H$ for HT7463B, $T_A=25^\circ C$, unless otherwise noted

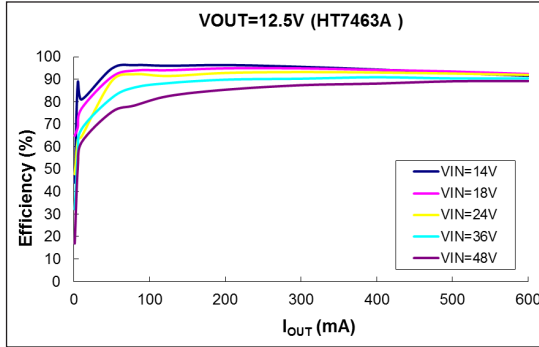

Efficiency vs. Load (HT7463A, $V_{OUT}=12.5V$)

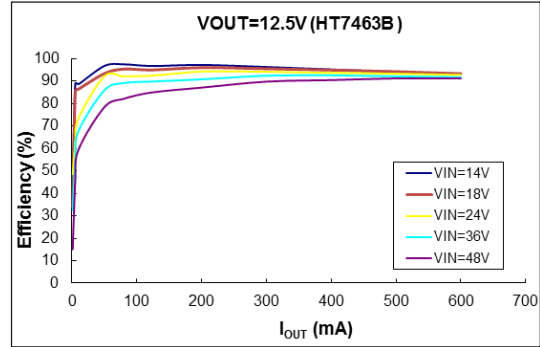

Efficiency vs. Load (HT7463B, $V_{OUT}=12.5V$)

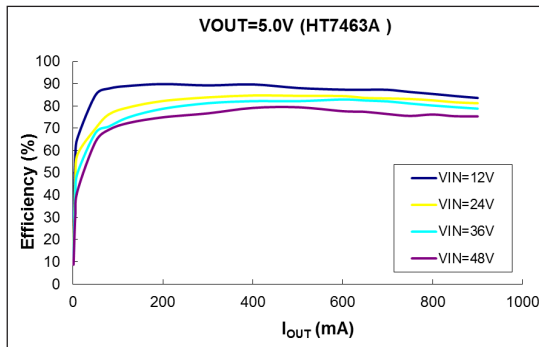

Efficiency vs. Load (HT7463A, $V_{OUT}=5.7V$)

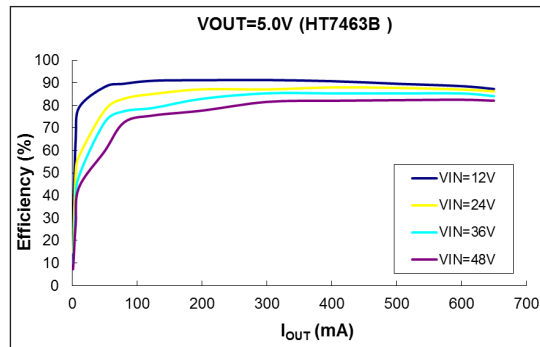

Efficiency vs. Load (HT7463B, $V_{OUT}=5.7V$)

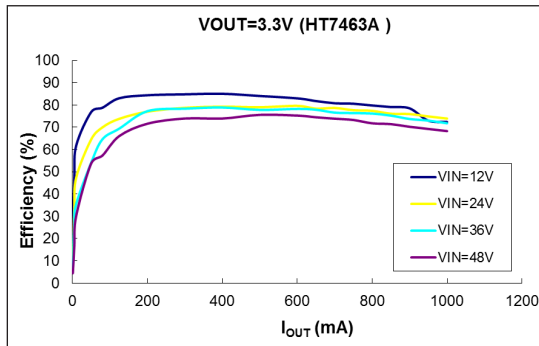

Efficiency vs. Load (HT7463A, $V_{OUT}=3.3V$)

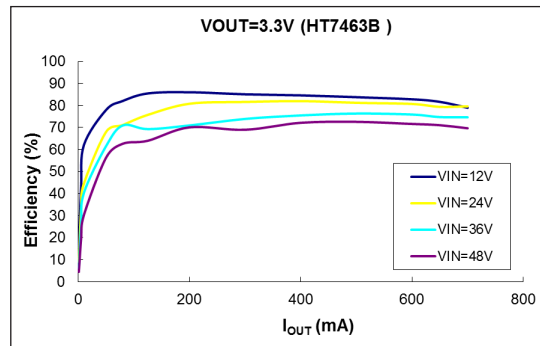

Efficiency vs. Load (HT7463B, $V_{OUT}=3.3V$)

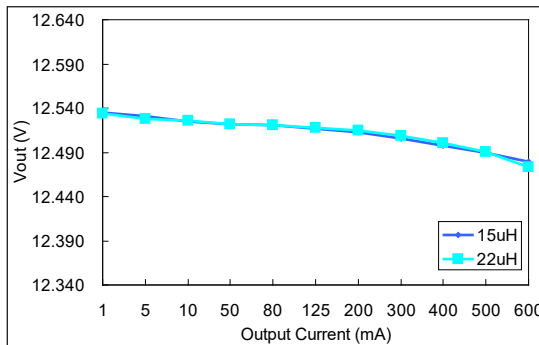

Load Regulation (HT7463A, $V_{OUT}=12.5V$)

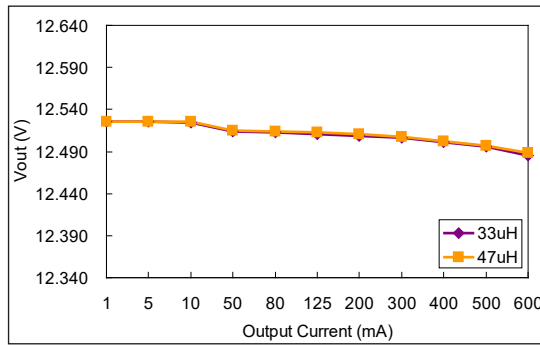

Load Regulation (HT7463B, $V_{OUT}=12.5V$)

Typical Performance Characteristics (Continued)

$V_{IN}=18V$, $V_{OUT}=12.5V$, $L=22\mu H$ for HT7463A and $L=47\mu H$ for HT7463B, $T_A=25^\circ C$, unless otherwise noted

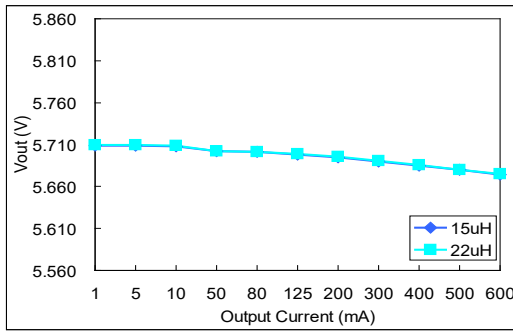

Load Regulation (HT7463A, $V_{OUT}=5.7V$)

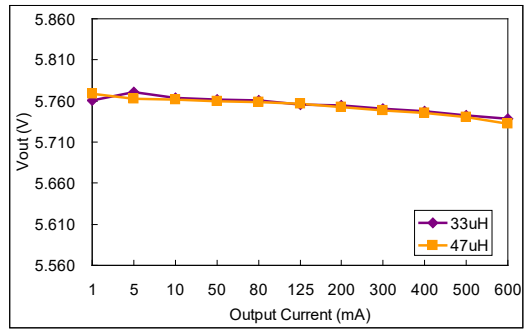

Load Regulation (HT7463B, $V_{OUT}=5.7V$)

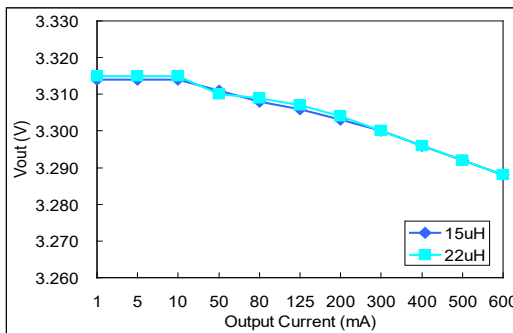

Load Regulation (HT7463A, $V_{OUT}=3.3V$)

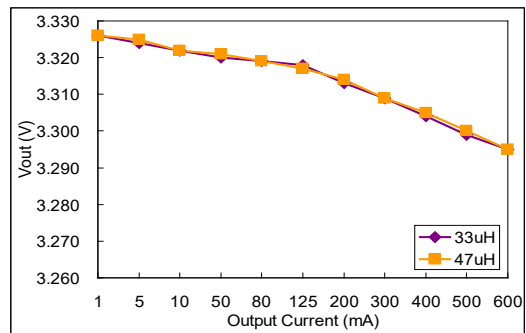

Load Regulation (HT7463B, $V_{OUT}=3.3V$)

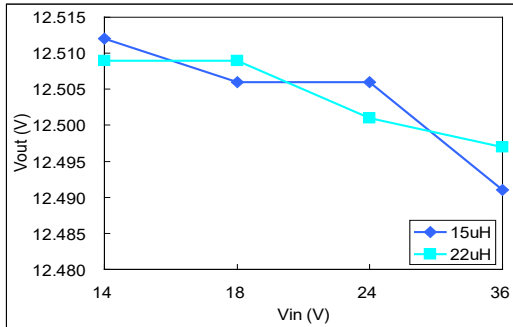

Line Regulation (HT7463A, $V_{OUT}=12.5V$, $I_{OUT}=300mA$)

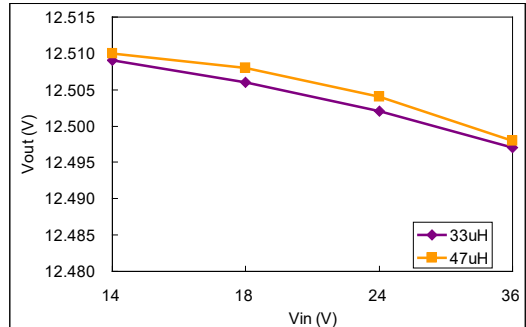

Line Regulation (HT7463B, $V_{OUT}=12.5V$, $I_{OUT}=300mA$)

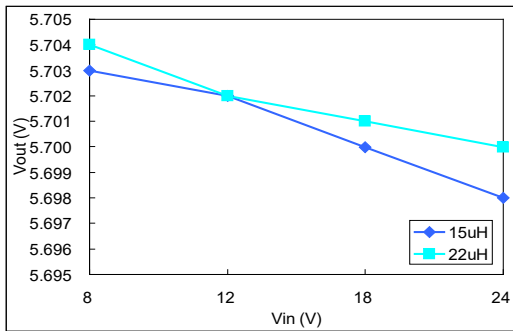

Line Regulation (HT7463A, $V_{OUT}=5.7V$, $I_{OUT}=300mA$)

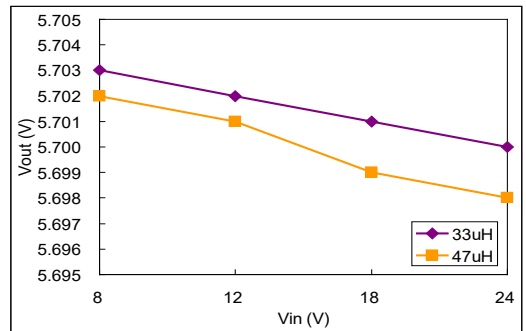

Line Regulation (HT7463B, $V_{OUT}=5.7V$, $I_{OUT}=300mA$)

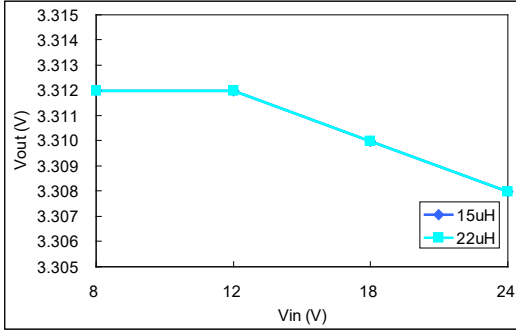

Line Regulation (HT7463A, V_{OUT}=3.3V, I_{OUT}=300mA)

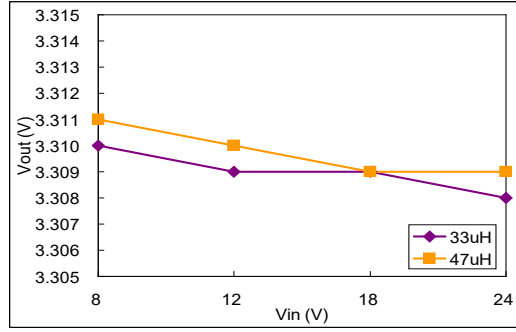

Line Regulation (HT7463B, V_{OUT}=3.3V, I_{OUT}=300mA)

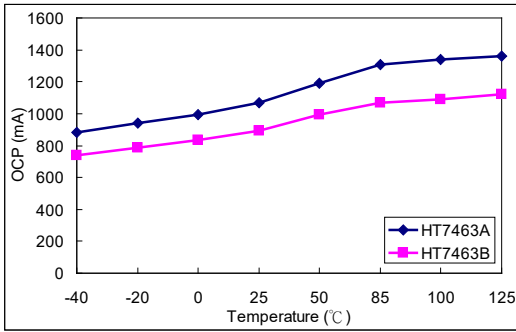

IOCP vs. TEMP (HT7463A and HT7463B)

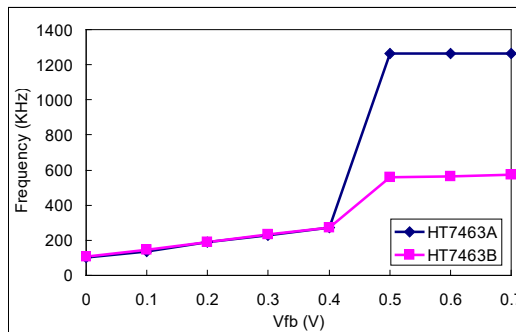

f_{sw} vs. VFB (HT7463A and HT7463B)

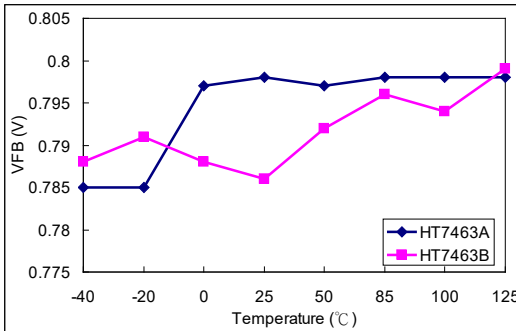

VFB vs. TEMP (HT7463A and HT7463B)

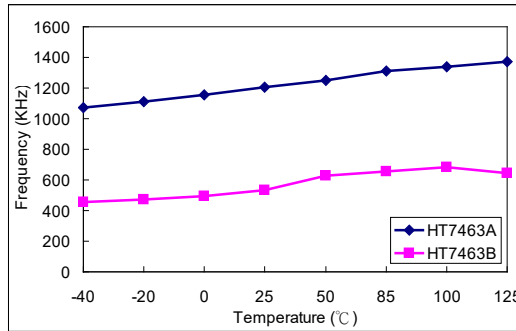

f_{sw} vs. TEMP (HT7463A and HT7463B)

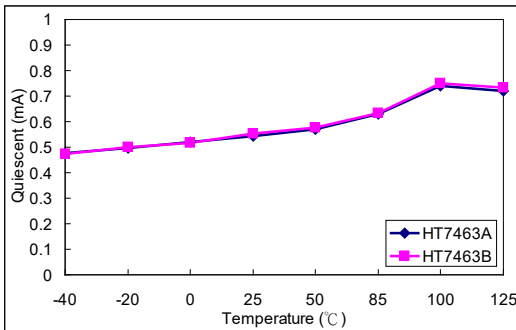

ICC vs. TEMP (HT7463A and HT7463B)

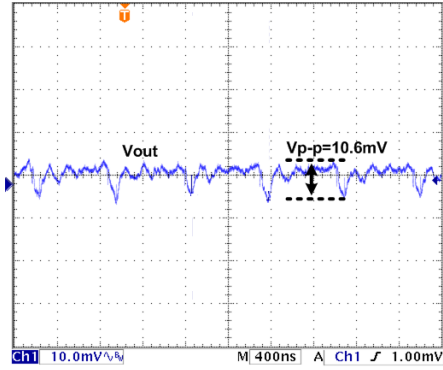

Output Ripple (HT7463A, $I_{OUT}=400mA$)

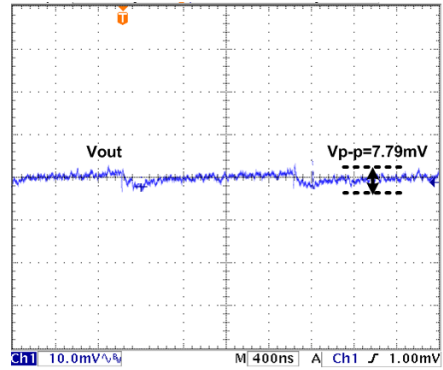

Output Ripple (HT7463B, $I_{OUT}=400mA$)

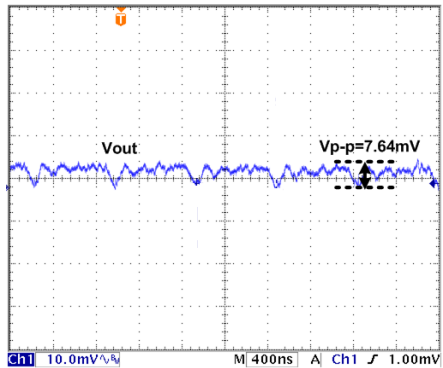

Output Ripple (HT7463A, $I_{OUT}=125mA$)

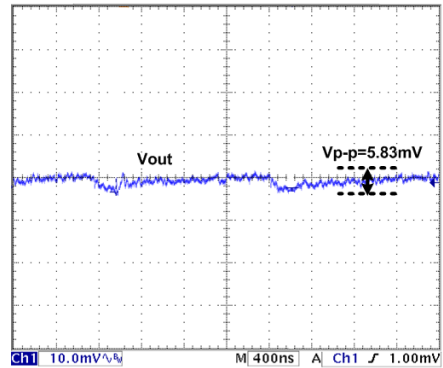

Output Ripple (HT7463B, $I_{OUT}=125mA$)

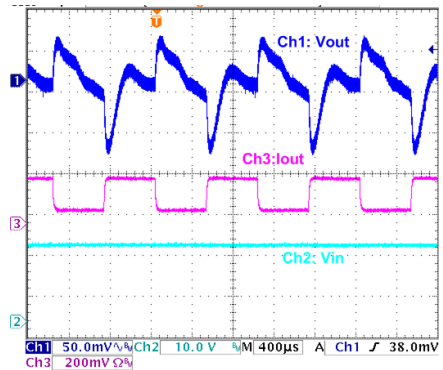

Load Transient (HT7463A, $I_{OUT}=50mA$ to $200mA$)

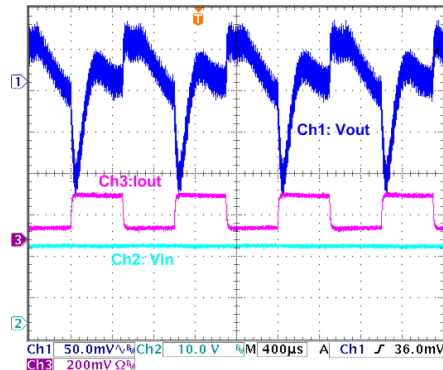

Load Transient (HT7463B, $I_{OUT}=50mA$ to $200mA$)

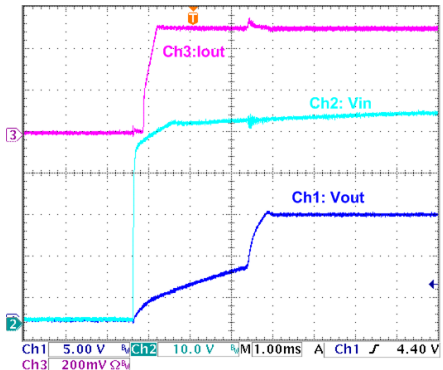

Power Up (HT7463A, $V_{IN}=52V$, $I_{OUT}=500mA$)

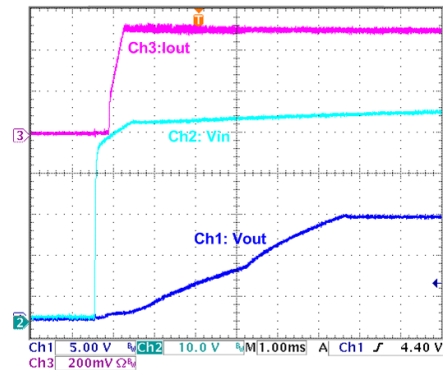

Power Up (HT7463B, $V_{IN}=52V$, $I_{OUT}=500mA$)

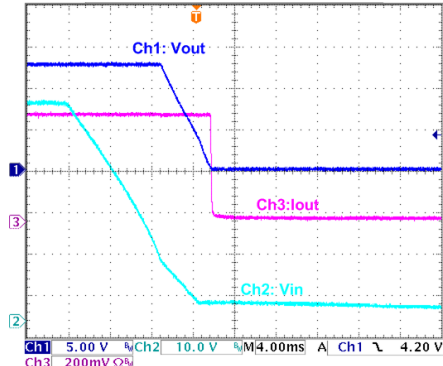

Power Down (HT7463A, $V_{IN}=52V$, $I_{OUT}=500mA$)

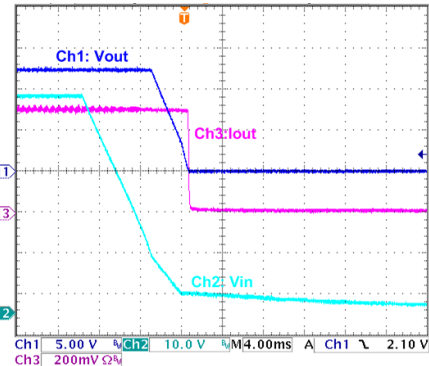

Power Down (HT7463B, $V_{IN}=52V$, $I_{OUT}=500mA$)

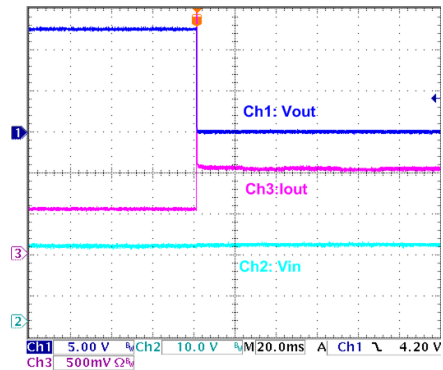

Output Short (HT7463A, $I_{OUT}=500mA$)

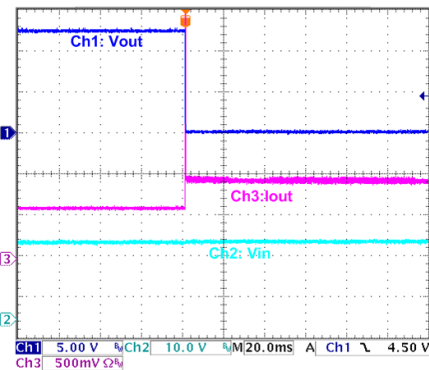

Output Short (HT7463B, $I_{OUT}=500mA$)

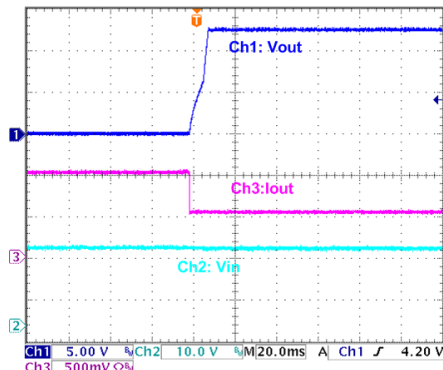

Short Recovery (HT7463A, $I_{OUT}=500mA$)

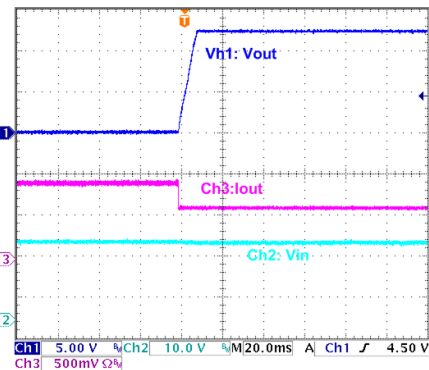

Short Recovery (HT7463B, $I_{OUT}=500mA$)

Functional Description

Output Voltage Setup

The external resistor divider sets the output voltage, for details see the Application Circuit. The feedback resistor, R1, also sets the feedback loop bandwidth with the internal compensation capacitor. R2 is calculated using the following equation:

$$R2 = R1 / ((V_{OUT} / 0.794V) - 1) \Omega$$

Protection Features

The devices include dedicated protection circuitry which is fully active during normal operation for full device protection. The thermal shutdown circuitry turns off power to the device when the die temperature reaches excessive levels. The UVLO comparator protects the power device during supply power startup and shutdown to prevent operation at voltages less than the minimum input voltage. The HT7463A/B also features a shutdown mode decreasing the supply current to approximately 0.1μA.

Recommended Operating Area

The recommended operating area is related to the frequency, minimum on time, minimum off time, over current and stability. The selection of the HT7463A/HT7463B can be implemented by referring the following Recommended Operating Area figure according to input/output voltage requirements. For example, if the input voltage is 30V and the output voltage is 5V, $V_{OUT}/V_{IN} = 5V/30V = 16.67\%$, refer to the figure below, Y-axis V_{IN} is 30V, HT7463B is recommended. If the input voltage minus the output voltage is lower than 2.5V and no load, refer to Component Selection for Low input & No-load to adjust the feedback resistor value.

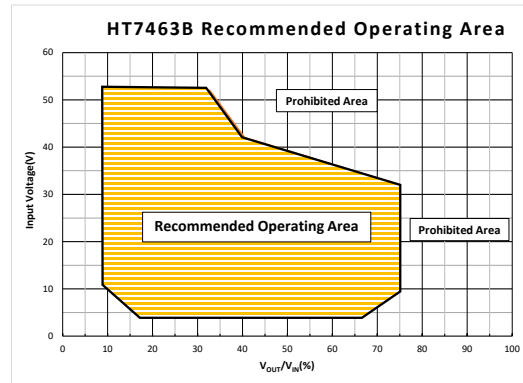
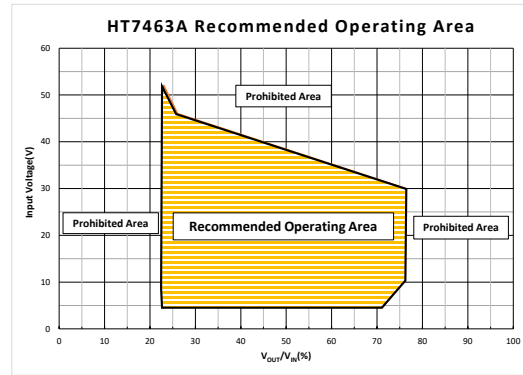

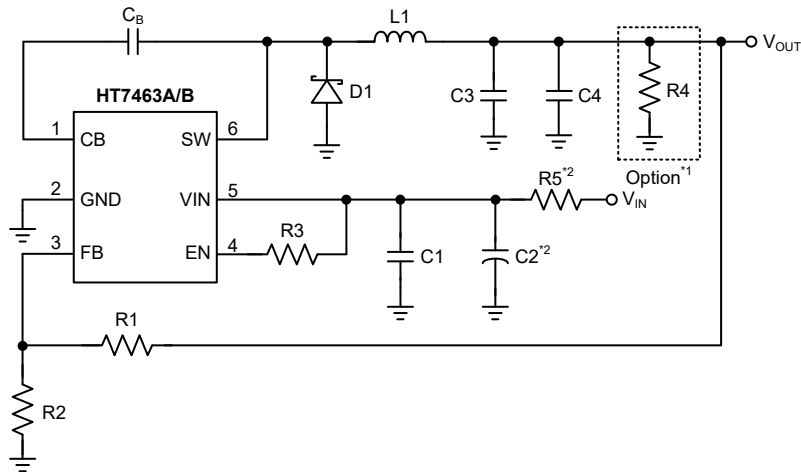
Recommended Component Values

Note: 1. Add a dummy load R4 in order to keep stability when input voltage is lower than 5.0V and no load. Please refer to component selection for low input voltage and no load description below.

2. R5 and C2 values can refer to the Input Voltage Rising Time.

Component Recommended Values

V _{OUT} (V)	Package	R1 (kΩ)	R2 (kΩ)
3.3	SMD 0603	51 (±1%)	16 (±1%)
5.0		82 (±1%)	15 (±1%)
12.5		91 (±1%)	6.2 (±1%)

Reference	Package	Description	Part Number	Mfgr.
C1,C3	SMD 0603	CAP 0.1μF/50V	GRM188R71H104JA93D	Murata
C2	DIP	68μF/63V	LGK Series	Liket Corp
C4	DIP	47μF/25V	LGK Series	Liket Corp
CB	SMD 0603	CAP 0.1μF/50V	GRM188R71M104K9	Murata
L1	5.8mm×5.2mm×4.5mm	HT7463A: 15μH/22μH	GS54-150K / GS54-220K	Gang Song
		HT7463B: 33μH/47μH	GS54-330K / GS54-470K	
D1	DO-214AC	Schottky Rectifier	SS16	Fairchild
R3	SMD 0603	100kΩ(±1%)	—	—

Frequency Fold-back Function

The devices include a frequency fold-back function to prevent situations of over current when the output is shorted. It efficiently reduces overheating even if the output is shorted. This function is implemented by changing the switching frequency according to the feedback voltage, V_{FB} . When the output node is shorted, the device will reduce the frequency to 105kHz for the HT7463A/HT7463B respectively resulting in a clamped input current. The HT7463A/HT7463B operates at a frequency of 1250/550kHz under normal conditions and the feedback voltage is about 0.794V.

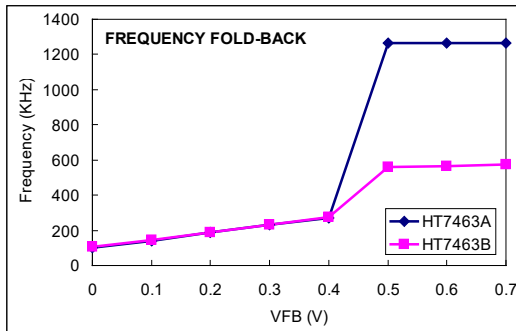

EN Pin Setting

For the HT7463A/B to start up correctly, the EN pin should be connected to VIN pin by R3 resistor. R3 recommended value is 0Ω~200kΩ.

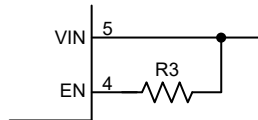

Input Voltage Rising Time

For the application input voltage rising time, the slew rate must be greater than 30mV/μs. When the input voltage rising time is too sharp, the R5 and C2 suggested values are as follows. C2 is recommended to use ceramic capacitors for a low ESR and small temperature coefficient. The EN pin is short connected to the VIN pin.

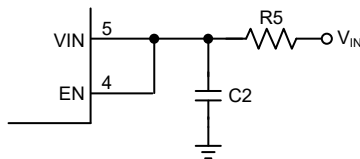

V_{IN}	R5 Resistance Value	C2 Capacitance Value
7V~15V	2.5Ω	>44μF
15V~26V	5Ω	>44μF
>26V	5Ω	>68μF

I_{OUT}	R5 Recommended Package
<100mA	SMD 0805 (1/8W)
>100mA	SMD 2512 (1W)

Component Selection Guide

Inductor

Use an inductor with a DC current rating at least 25% percent higher than the maximum load current for most applications. The DC resistance of the inductor is a key parameter affecting efficiency. With regard to efficiency, the inductor's DC resistance should be less than 200mΩ. For most application, the inductor value can be calculated from the following equation.

$$L = \frac{V_{out} \times (V_{IN} - V_{out})}{V_{IN} \times I_{ripple} \times f_{sw}}$$

A higher value of ripple current reduces the inductance value, but increases the conductance loss, core loss, and current stress for the inductor and switch devices. A suggested choice is for the inductor ripple current to be 30% of the maximum load current.

If some electromagnetic interference situation, suggest inductor value 100μH or more.

Input Capacitor

A low ESR ceramic capacitor (CIN) is needed between the VIN pin and GND pin. Use ceramic capacitors with X5R or X7R dielectrics for their low ESRs and small temperature coefficients. For most applications, a 2.2μF- 10μF capacitor will suffice.

Output Capacitor

The selection of COUT is driven by the maximum allowable output voltage ripple. Use ceramic capacitors with X5R or X7R dielectrics for their low ESR characteristics. Capacitors in the range of 22μF to 100μF are a good starting point with an ESR of 0.1Ω or less.

330μF is recommended to achieve 1% output ripple requirement.

Schottky Diode

The breakdown voltage rating of the diode should be higher than the maximum input voltage. The current rating for the diode should be equal to the maximum output current to ensure the best reliability in most applications. In this case it is possible to use a diode with a lower average current rating, however the peak current rating should be higher than the maximum load current.

Bootstrap Capacitor

A 0.1μF ceramic capacitor or larger is recommended for the bootstrap capacitor. Generally a 0.1μF to 1μF value can be used to ensure sufficient gate drive for the internal switches and a consistently low R_{DS(ON)}.

Component Selection for Low-input Voltage & No-load

When the input voltage is lower than 5.0V and no load, in order to keep stability, two methods listed below can be used.

Reduce the low-side feedback resistor to 0.8KΩ. The recommended value is listed below.

V _{OUT} (V)	Package	R1 (kΩ)	R2 (kΩ)
3.3	SMD 0603	2.5 (±1%)	0.8 (±1%)

Add a dummy load R3. The value is calculated by the following equation.

$$R3 = V_{OUT}/0.001\Omega$$

Layout Consideration Guide

To reduce problems with conducted noise, there are some important points to consider regarding the PCB layout.

- Ensure all feedback connections are short and direct. Place the feedback resistors and compensation components as close to the FB pin as possible.
- The input bypass capacitor must be placed close to the VIN pin.
- The inductor, schottky diode and output capacitor trace should be as short as possible to reduce conducted and radiated noise and increase overall efficiency.
- Keep the power ground connection as short and wide as possible.

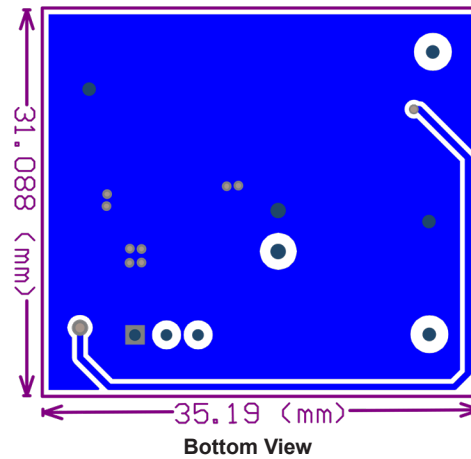
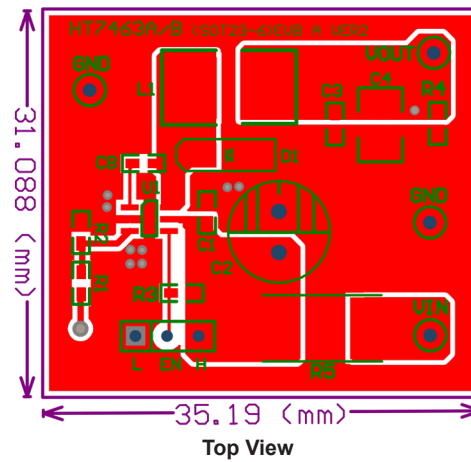

Thermal Considerations

The maximum power dissipation depends on the thermal resistance of the IC package, the PCB layout, the rate of the surrounding airflow and the difference between the junction and ambient temperature. The maximum power dissipation can be calculated by the following formula:

$$P_{D(MAX)} = (T_{J(MAX)} - T_A) / \theta_{JA}$$

where $T_{J(MAX)}$ is the maximum junction temperature, T_A is the ambient temperature and θ_{JA} is the junction-to-ambient thermal resistance of the IC package (220°C/W for 6-pin SOT23)

For maximum operating rating conditions, the maximum junction temperature is 150°C. However, it is recommended that the maximum junction temperature does not exceed 125°C in normal operation to maintain reliability. The derating curve for maximum power dissipation is as follows:

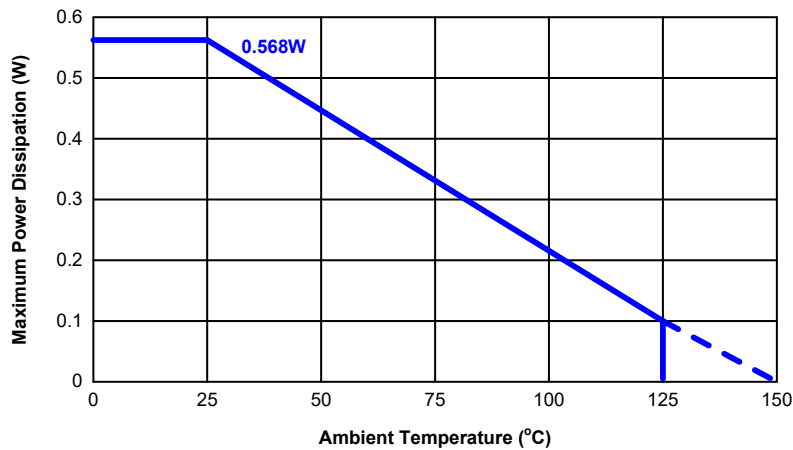

Package Information

Note that the package information provided here is for consultation purposes only. As this information may be updated at regular intervals users are reminded to consult the [Holtek website](#) for the latest version of the [Package/Carton Information](#).

Additional supplementary information with regard to packaging is listed below. Click on the relevant section to be transferred to the relevant website page.

- Package Information (include Outline Dimensions, Product Tape and Reel Specifications)
- The Operation Instruction of Packing Materials
- Carton information

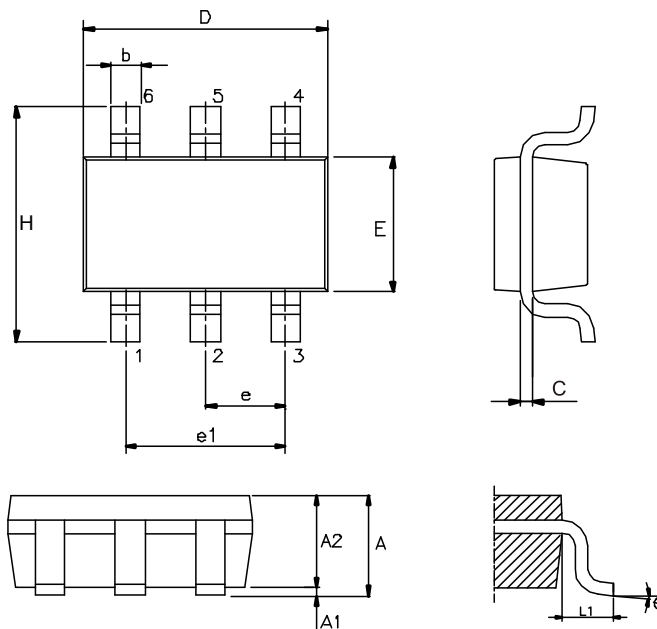
6-pin SOT23 Outline Dimensions

Symbol	Dimensions in inch		
	Min.	Nom.	Max.
A	—	—	0.057
A1	—	—	0.006
A2	0.035	0.045	0.051
b	0.012	—	0.020
C	0.003	—	0.009
D	—	0.114 BSC	—
E	—	0.063 BSC	—
e	—	0.037 BSC	—
e1	—	0.075 BSC	—
H	—	0.110 BSC	—
L1	—	0.024 BSC	—
theta	0°	—	8°

Symbol	Dimensions in mm		
	Min.	Nom.	Max.
A	—	—	1.45
A1	—	—	0.15
A2	0.90	1.15	1.30
b	0.30	—	0.50
C	0.08	—	0.22
D	—	2.90 BSC	—
E	—	1.60 BSC	—
e	—	0.95 BSC	—
e1	—	1.90 BSC	—
H	—	2.80 BSC	—
L1	—	0.60 BSC	—
theta	0°	—	8°

Copyright© 2022 by HOLTEK SEMICONDUCTOR INC.

The information provided in this document has been produced with reasonable care and attention before publication, however, Holtek does not guarantee that the information is completely accurate and that the applications provided in this document are for reference only. Holtek does not guarantee that these explanations are appropriate, nor does it recommend the use of Holtek's products where there is a risk of personal hazard due to malfunction or other reasons. Holtek hereby declares that it does not authorize the use of these products in life-saving, life-sustaining or critical equipment. Holtek accepts no liability for any damages encountered by customers or third parties due to information errors or omissions contained in this document or damages encountered by the use of the product or the datasheet. Holtek reserves the right to revise the products or specifications described in the document without prior notice. For the latest information, please contact us.