

HW Series – 22mm IEC Style Global Pushbuttons

Key features:

- Locking lever removable contact blocks
- Finger-safe IP20 contacts as standard, other terminal styles available
- Tamperproof construction
- All E-stops meet EN418 and are compliant with SEMI S2 standards
- Worldwide approvals
- Easy to assemble
- Choice of black plastic or metallic front bezels
- Incandescent or LED illumination
- Transformer or full voltage
- Slow make double break self cleaning contacts



HW: The Best Engineered Switch in the World

IDEC's HW switches are "The best engineered switch in the world" for a reason. Carrying the CE mark, UL, CSA, CCC (Chinese), and TUV approvals, these switches are designed for use in almost any part of the world.

lights, selector switches, and emergency stop switches.

All switches also incorporate mechanically keyed safety locking levers, ensuring correct installation and maintaining safety in high-vibration applications.

Complete with finger-safe contact blocks offering IP20 protection, these 7/8" (22mm) switches include illuminated and non-illuminated pushbuttons, pilot



File No. E68961



File No. LR92374



Registration No. R9551089 (E-stops)
 Registration No. R50054316 (Dual Pushbuttons)
 Registration No. J9650511 (Pilot Lights)
 Registration No. J9551458 (all other switches)









TÜV Rheinland
 Certificate No.
 2005010305145656



Specifications

| | | |
|--------------|---------------------------------------------------------------------------------|----------------------------------------------------------------------------------------------------------------------------------------------------------------|
| Electrical | Rated Operational Characteristics | AC-15: A600 or Ue = 250V, Ie = 3A (NO, NC, NO-EM, NC-LB) DC-13: P600 or Ue = 125V, Ie = 1.1A (NO, NC) DC-13: Q600 or Ue = 125V, Ie = 0.9A (NO-EM, NC-LB) |
| | Maximum Inrush Current | 40 A (40 ms) |
| | Rated Insulation Voltage | 600V |
| | Rated Switching Over-Voltage | Less than 4kV, conforming to IEC60947-1 |
| | Rated Impulse Withstanding Voltage | 4kV for contact circuit, 2.5kV for lamp circuit |
| | Rated Thermal Current | 10 Amp |
| | Minimum Switching Capacity | 5 mA at 3V AC/DC |
| | Electrical Reliability | MTBF < 1 fault for 10 million operation cycles (3V DC, 5mA) |
| Lamp Ratings | Incandescent: 1 W LEDs: 6V/17mA max, 12V & 24V/11mA max, 120 & 240V/10mA max | |

| | | | | | | | | | |
|----------------------------------|-----------------------------------------------------------------------------------------|-------------------------------------------------------------------------------------------------------------------------------------------------------------------------------------------------------------------------------------------------------------------------------------------------------------------------------------------------------------------------------------------------------------------------------------------------------------------------------------------------------------------------------------------------------------------------------------------------------------------------------------------------------------------------------------------------------------|------------------------------------------------------|-----|-----|------|------|----------------------|----|
| Mechanical | Contact Operation | Slow break NC or NO, self-cleaning | | | | | | | |
| | Positive Action Operation (Emergency Stops with NC contacts) | 5.5mm to 10mm travel to latch, 45N minimum force to latch 10mm maximum travel, 1,800 operations per hour maximum for a Pushlock Turn Reset 900 operations per hour maximum for a Push-Pull | | | | | | | |
| | Operating Force | Flush and extended pushbuttons—with 1NO or 1NC contact: 6.2±2N (momentary), 7.0±2N (maintained) Additional contacts—1NO or 1NC: +3.2N (momentary), + 3.3N (maintained) | | | | | | | |
| | Recommended Terminal Torque | 0.8 N m (7.1 in lb.) | | | | | | | |
| | Applicable Wire Size | Minimum 1 x 22 AWG, max. 2 x 14 AWG or 1 x 12 AWG | | | | | | | |
| | Contact Resistance | Initial contact resistance of 50mΩ or less | | | | | | | |
| | Contact Gap | 4mm (NO and NC), 2mm (NO-EM and NC-LB) | | | | | | | |
| | Horsepower Rating | Reference Value: 1/4 HP @ 120V (1Ø non-reversing), 1HP @ 240V (3Ø non-reversing) | | | | | | | |
| | Contact Material | Silver (gold plated contacts available - contact IDEC) | | | | | | | |
| | Operating Temperature | Operation: -25 to +50°C (without freezing), Storage: -40 to +70°C (without freezing) | | | | | | | |
| Vibration Resistance | 10 to 55Hz, 98m/sec ² (10G) conforming to IEC6068-2-6 | | | | | | | | |
| Shock Resistance | 980m/sec ² (100G) conforming to IEC6068-2-7 | | | | | | | | |
| Mechanical Life | Momentary pushbuttons: 5,000,000 (900 operations per hour), All other switches: 500,000 | | | | | | | | |
| Conforming to Standards | EN60947-1, EN60947-5-1, VDE0660-200, UL508, CSA C22-2 No.14 | | | | | | | | |
| Standards & Approvals | Approvals |  File No. E68961  File No. LR92374   Registration No. R9551089 (E-stops) Registration No. R50054316 (Dual Pushbuttons) Registration No. J9650511 (Pilot Lights) Registration No. J9551458 (all other switches)  TÜV Rheinland Certificate No. 2005010305145656 | | | | | | | |
| | Electric Shock Protection | Class 0 conforming to IEC60536 | | | | | | | |
| | Degree of Protection (conforming to IEC60529) (conforming to NEMA ICS6-110) | IP65 (from front of the panel) IP20 (Type HW-F contact block) NEMA 1, 2, 3, 3R, 3S, 4, 4X, 5, 12, 13 (from front of panel) | | | | | | | |
| | Pollution Degree (conforming to IEC60947-1) | 3 for switches not using a transformer, 2 for switches using a transformer | | | | | | | |
| | External Short-Circuit Protection | 10A 250V fuse conforming to IEC60269-1 | | | | | | | |
| Terminal Referencing | Conforming to CENELEC EN50005 | | | | | | | | |
| Contact Ratings | Pushbuttons | Contact Block | | | | | | Type HW-C/HW-F /HW-G | |
| | Illuminated Pushbuttons | Rated Insulation Voltage | 600V | | | | | | |
| | Selector Switches | Rated Continuous Current | 10A | | | | | | |
| | Illuminated Selector Switches Pushbutton Selectors | Contact Ratings by Utilization Category IEC 60947-5-1 | AC-15 (A600) DC-13 (P600) | | | | | | |
| Characteristics | Operational Voltage | | 24V | 48V | 50V | 110V | 220V | 440V | |
| | Operational Current | AC 50/60 Hz | AC-12 Control of resistive loads & solid state loads | 10A | — | 10A | 10A | 6A | 2A |
| | | | AC-15 Control of electromagnetic loads (> 72VA) | 10A | — | 7A | 5A | 3A | 1A |
| | | DC | DC-12 Control of resistive loads & solid state loads | 8A | 5A | — | 2.2A | 1.1A | — |
| | | | DC-13 Control of electromagnets | 5A | 2A | — | 1.1A | 0.6A | — |

 For dimensions, see page 601.

LED Lamp Ratings (LSTD Type)

| Model | | | LSTD-6② | LSTD-1② | LSTD-2② | LSTD-H2② | LSTD-M4② |
|------------------------|---------|-------------------|--------------------------------------------------------------------------------------------------------------|----------------|----------------|-------------|-------------|
| Lamp Base | | | BA9S/13 | | | | |
| Rated Voltage | | | 6V AC/DC | 12V AC/DC | 24V AC/DC | 120V AC | 240V AC |
| Voltage Range | | | 6V AC/DC ±10% | 12V AC/DC ±10% | 24V AC/DC ±10% | 120V AC ±5% | 240V AC ±5% |
| Current Draw | AC | A, R, W: G, S: | 17mA 8mA | 11mA | 11mA | 10mA | 10mA |
| | DC | A, R, W: G, S: | 14mA 5.5mA | 10mA | 10mA | — | — |
| Color Code | | | A (amber), G (green), R (red), S (blue), W (white) | | | | |
| Lamp Base Color | | | Same as illumination color | | | | |
| Voltage Marking | | | Die stamped on the base | | | | |
| Life (reference value) | | | Approx. 50,000 hours (The luminance reduces to 50% the initial intensity when used on complete DC.) | | | | |
| Internal Circuit | A, R, W | | | | | | |
| | A, R, W | | | | | | |
| | G, S | | | | | | |
| | | | <ul style="list-style-type: none"> LED Chip Protection Diode Zener Diode | | | | |

In place of ②, specify the Lens/LED Color Code.

Switches & Pilot Devices

Signaling Lights

Relays & Sockets

Timers

Contactors

Terminal Blocks

Circuit Breakers

Non-Illuminated Round Pushbuttons (Assembled)



| Function | Contacts | Round Flush | | Round Extended | |
|------------|---------------|------------------|------------------|------------------|------------------|
| | | Plastic Bezel | Metal Bezel | Plastic Bezel | Metal Bezel |
| Momentary | Operator Only | <i>HW1B-M1-①</i> | <i>HW4B-M1-①</i> | <i>HW1B-M2-①</i> | <i>HW4B-M2-①</i> |
| | 1NO | HW1B-M1F10-① | HW4B-M1F10-① | HW1B-M2F10-① | HW4B-M2F10-① |
| | 1NC | HW1B-M1F01-① | HW4B-M1F01-① | HW1B-M2F01-① | HW4B-M2F01-① |
| | 1NO-1NC | HW1B-M1F11-① | HW4B-M1F11-① | HW1B-M2F11-① | HW4B-M2F11-① |
| | 2NO | HW1B-M1F20-① | HW4B-M1F20-① | HW1B-M2F20-① | HW4B-M2F20-① |
| | 2NC | HW1B-M1F02-① | HW4B-M1F02-① | HW1B-M2F02-① | HW4B-M2F02-① |
| | 2NO-2NC | HW1B-M1F22-① | HW4B-M1F22-① | HW1B-M2F22-① | HW4B-M2F22-① |
| Maintained | Operator Only | <i>HW1B-A1-①</i> | <i>HW4B-A1-①</i> | <i>HW1B-A2-①</i> | <i>HW4B-A2-①</i> |
| | 1NO | HW1B-A1F10-① | HW4B-A1F10-① | HW1B-A2F10-① | HW4B-A2F10-① |
| | 1NC | HW1B-A1F01-① | HW4B-A1F01-① | HW1B-A2F01-① | HW4B-A2F01-① |
| | 1NO-1NC | HW1B-A1F11-① | HW4B-A1F11-① | HW1B-A2F11-① | HW4B-A2F11-① |
| | 2NO | HW1B-A1F20-① | HW4B-A1F20-① | HW1B-A2F20-① | HW4B-A2F20-① |
| | 2NC | HW1B-A1F02-① | HW4B-A1F02-① | HW1B-A2F02-① | HW4B-A2F02-① |
| | 2NO-2NC | HW1B-A1F22-① | HW4B-A1F22-① | HW1B-A2F22-① | HW4B-A2F22-① |

① Button Color Code

| Color | Code |
|--------|------|
| Black | B |
| Green | G |
| Red | R |
| Blue | S |
| White | W |
| Yellow | Y |
| Gray | N* |

*Gray available for round flush only.



1. In place of ①, specify the Button Color Code from table below.
2. For nameplates and accessories, see page 596 and 599.
3. For dimensions, see page 601.
4. For contact assembly part numbers, see page 600.
5. All assembled part numbers in catalog include standard, fingersafe (HW-F...) contacts.
6. Assembled units with spring-up terminals (HW-G...) can be ordered by removing an "F" from the part number (Ex. HW1B-M1F11-R becomes HW1B-M111-R).
7. Operator only models include operator plus button.
8. Additional contact configurations available (up to 6 total contacts).

Part Number Structure

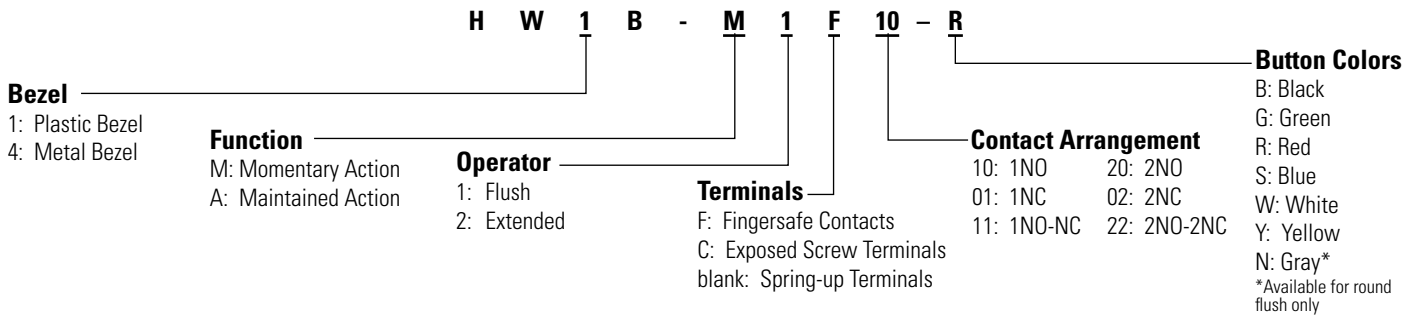

Non-Illuminated Round Pushbuttons (Replacement Parts)

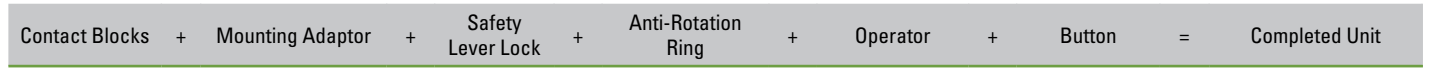

Contact Blocks

| Style | Contacts | 1NO | 1NC |
|-------|----------------------------|----------------------|----------------------|
| | Standard Fingersafe (IP20) | HW-F10 | HW-F01 |
| | | HW-F10R (early make) | HW-F01R (late break) |
| | Spring-Up Terminal | HW-G10 | HW-G01 |
| | | HW-G10R (early make) | HW-G01R (late break) |
| | Exposed Screw Terminal | HW-C10 | HW-C01 |
| | | HW-C10R (early make) | HW-C01R (late break) |
| | Dummy Block | TW-DB | |

Contact Block Mounting Adaptor

| Style | Part Number |
|-------|-------------|
| | HW-CB2C |

- 1. Used to mount contact blocks to operator.
- 2. IDEC strongly recommends using the safety lever lock to prevent heavy vibration or maintenance personnel from inadvertently unlocking contacts.

Anti-Rotation Ring

| Style | Part Number |
|-------|-------------|
| | HW9Z-RL |

Use with notched panel cutout to prevent unit rotation.

Operators

| Style | Plastic Bezel | Metal Bezel | |
|-------|---------------|-------------|---------|
| | Momentary | HW1B-M0 | HW4B-M0 |
| | Maintained | HW1B-A0 | HW4B-A0 |

Safety Lever Lock

| Style | Part Number |
|-------|-------------|
| | HW9Z-LS |

Buttons

| Style | Part Number |
|--------------------|-------------|
| Round Flush | HW1A-B1-⓪ |
| Round Extended | HW1A-B2-⓪ |

1. In place of ⓪, specify the Button Color Code from table.

⓪ Button Color Code

| Color | Code | Color | Code |
|-------|------|--------|------|
| Black | B | White | W |
| Green | G | Yellow | Y |
| Red | R | Gray | N* |
| Blue | S | | |

*Gray available for round flush only.

Non-Illuminated Mushroom Head Pushbuttons (Assembled)



| Function | Contacts | ø29mm Mushroom Head | | ø40mm Mushroom Head | |
|------------|----------------------|---------------------|------------------|---------------------|------------------|
| | | Plastic Bezel | Metal Bezel | Plastic Bezel | Metal Bezel |
| Momentary | <i>Operator Only</i> | HW1B-M3-① | HW4B-M3-① | HW1B-M4-① | HW4B-M4-① |
| | 1NO | HW1B-M3F10-① | HW4B-M3F10-① | HW1B-M4F10-① | HW4B-M4F10-① |
| | 1NC | HW1B-M3F01-① | HW4B-M3F01-① | HW1B-M4F01-① | HW4B-M4F01-① |
| | 1NO-1NC | HW1B-M3F11-① | HW4B-M3F11-① | HW1B-M4F11-① | HW4B-M4F11-① |
| | 2NO | HW1B-M3F20-① | HW4B-M3F20-① | HW1B-M4F20-① | HW4B-M4F20-① |
| | 2NC | HW1B-M3F02-① | HW4B-M3F02-① | HW1B-M4F02-① | HW4B-M4F02-① |
| | 2NO-2NC | HW1B-M3F22-① | HW4B-M3F22-① | HW1B-M4F22-① | HW4B-M4F22-① |
| Maintained | <i>Operator Only</i> | HW1B-A3-① | HW4B-A3-① | HW1B-A4-① | HW4B-A4-① |
| | 1NO | HW1B-A3F10-① | HW4B-A3F10-① | HW1B-A4F10-① | HW4B-A4F10-① |
| | 1NC | HW1B-A3F01-① | HW4B-A3F01-① | HW1B-A4F01-① | HW4B-A4F01-① |
| | 1NO-1NC | HW1B-A3F11-① | HW4B-A3F11-① | HW1B-A4F11-① | HW4B-A4F11-① |
| | 2NO | HW1B-A3F20-① | HW4B-A3F20-① | HW1B-A4F20-① | HW4B-A4F20-① |
| | 2NC | HW1B-A3F02-① | HW4B-A3F02-① | HW1B-A4F02-① | HW4B-A4F02-① |
| | 2NO-2NC | HW1B-A3F22-① | HW4B-A3F22-① | HW1B-A4F22-① | HW4B-A4F22-① |



| Function | Contacts | ø60mm Mushroom Head |
|-----------|----------------------|---------------------|
| | | Plastic Bezel |
| Momentary | <i>Operator Only</i> | HW1B-M5-①* |
| | 1NO | HW1B-M5F10-①* |
| | 1NC | HW1B-M5F01-①* |
| | 1NO-1NC | HW1B-M5F11-①* |
| | 2NO | HW1B-M5F20-①* |
| | 2NC | HW1B-M5F02-①* |
| | 2NO-2NC | HW1B-M5F22-①* |

① Button Color Code

| Color | Code |
|--------|------|
| Black | B |
| Green | G |
| Red | R |
| Blue | S |
| White | W |
| Yellow | Y |



1. In place of ①, specify the Button Color Code from table.
2. *60mm mushroom available only in red, green, black, and yellow.
3. For nameplates and accessories, see page 596 and 599.
4. For dimensions, see page 601.
5. For contact assembly part numbers, see page 600.
6. All assembled part numbers in catalog include standard fingersafe (HW-F...) contacts.
7. Assembled units with spring-up terminals (HW-G...) can be ordered by removing an "F" from the part number (Ex. HW1B-M1F11-R becomes HW1B-M111-R).
8. Units with exposed screw terminals (HW-C...) must be ordered as sub-components.
9. Operator only models include operator plus button.
10. Additional contact configurations available (up to 6 total contacts).

Part Number Structure

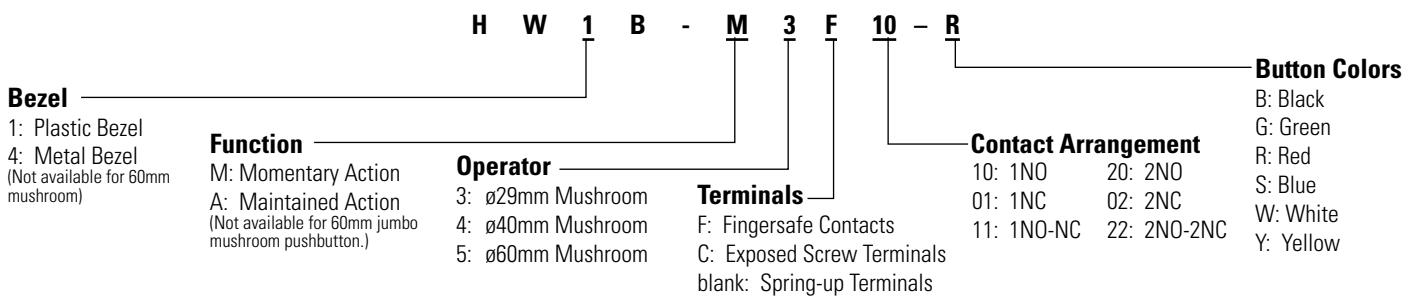

Non-Illuminated Mushroom Head Pushbuttons (Replacement Parts)

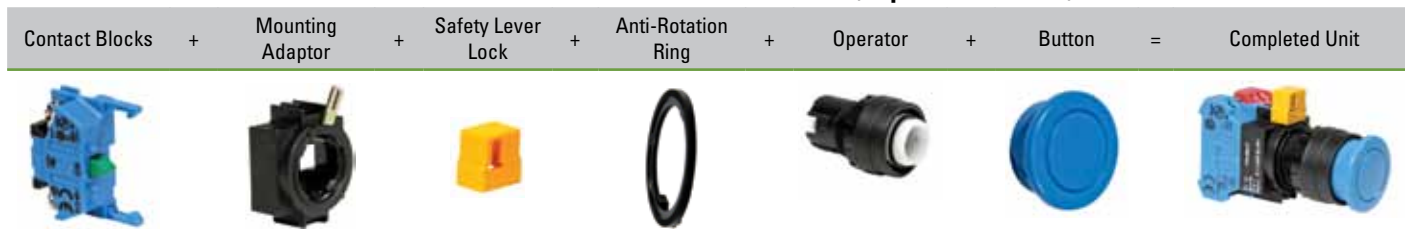

Contact Blocks

| Style | Contacts | 1NO | 1NC |
|-------|----------------------------|----------------------|----------------------|
| | Standard Fingersafe (IP20) | HW-F10 | HW-F01 |
| | | HW-F10R (early make) | HW-F01R (late break) |
| | Spring-Up Terminal | HW-G10 | HW-G01 |
| | | HW-G10R (early make) | HW-G01R (late break) |
| | Exposed Screw Terminal | HW-C10 | HW-C01 |
| | | HW-C10R (early make) | HW-C01R (late break) |
| | Dummy Block | TW-DB | |

Contact Block Mounting Adaptor

| Style | Part Number |
|-------|-------------|
| | HW-CB2C |

- 1. Used to mount contact blocks to operator.
- 2. IDEC strongly recommends using the safety lever lock to prevent heavy vibration or maintenance personnel from inadvertently unlocking contacts.

Safety Lever Lock

| Style | Part Number |
|-------|-------------|
| | HW9Z-LS |

Anti-Rotation Ring

| Appearance | Part Number |
|------------|-------------|
| | HW9Z-RL |

Operators

| Style | Plastic Bezel | Metal Bezel | |
|----------------------------------|---------------|-------------|----------|
| ø29mm Mushroom ø40mm Mushroom | Momentary | HW1B-M0L | HW4B-M0L |
| | Maintained | HW1B-A0L | HW4B-A0L |
| ø60mm Jumbo Mushroom | Momentary | HW1B-M5-⊙* | - |

- 1. *60mm mushroom operator includes non-removable button (available in red, black, green and yellow only).
- 2. For nameplates and accessories, see page 596 and 599.
- 3. For dimensions, see page 601.

Buttons

| Style | Part Number |
|--------------------|-------------|
| ø29mm Mushroom Cap | HW1A-B3-⊙ |
| | |
| ø40mm Mushroom Cap | HW1A-B4-⊙ |
| | |

- 1. In place of ⊙, specify the Button Color Code from table.

⊙ Button Color Code

| Color | Code | Color | Code |
|-------|------|--------|------|
| Black | B | Blue | S |
| Green | G | White | W |
| Red | R | Yellow | Y |

- HW1B-M5 available only in black, red, green and yellow.

Non-Illuminated Square Pushbuttons (Assembled)



| Function | Contacts | Square Flush | Square Extended |
|------------|----------------------|------------------|------------------|
| | | Plastic Bezel | Plastic Bezel |
| Momentary | <i>Operator Only</i> | HW2B-M1-① | HW2B-M2-① |
| | 1NO | HW2B-M1F10-① | HW2B-M2F10-① |
| | 1NC | HW2B-M1F01-① | HW2B-M2F01-① |
| | 1NO-1NC | HW2B-M1F11-① | HW2B-M2F11-① |
| | 2NO | HW2B-M1F20-① | HW2B-M2F20-① |
| | 2NC | HW2B-M1F02-① | HW2B-M2F02-① |
| | 2NO-2NC | HW2B-M1F22-① | HW2B-M2F22-① |
| Maintained | <i>Operator Only</i> | HW2B-A1-① | HW2B-A2-① |
| | 1NO | HW2B-A1F10-① | HW2B-A2F10-① |
| | 1NC | HW2B-A1F01-① | HW2B-A2F01-① |
| | 1NO-1NC | HW2B-A1F11-① | HW2B-A2F11-① |
| | 2NO | HW2B-A1F20-① | HW2B-A2F20-① |
| | 2NC | HW2B-A1F02-① | HW2B-A2F02-① |
| | 2NO-2NC | HW2B-A1F22-① | HW2B-A2F22-① |

① Button Color Code

| Color | Code |
|--------|------|
| Black | B |
| Green | G |
| Red | R |
| Blue | S |
| White | W |
| Yellow | Y |



1. In place of ①, specify the Button Color Code from table.
2. For nameplates and accessories, see page 596 and 599.
3. For dimensions, see page 601.
4. For contact assembly part numbers, see page 600.
5. Square pushbuttons available in plastic bezel only.
6. All assembled part numbers in catalog include standard fingersafe (HW-F...) contacts.
7. Assembled units with spring-up terminals (HW-G...) can be ordered by removing an "F" from the part number (Ex. HW2B-M1F11-R becomes HW1B-M111-R).
8. Units with exposed screw terminals (HW-C...) must be ordered as sub-components.
9. Operator only model includes operator and button.
10. Additional contact configurations available (up to 6 total contacts).

Part Number Structure

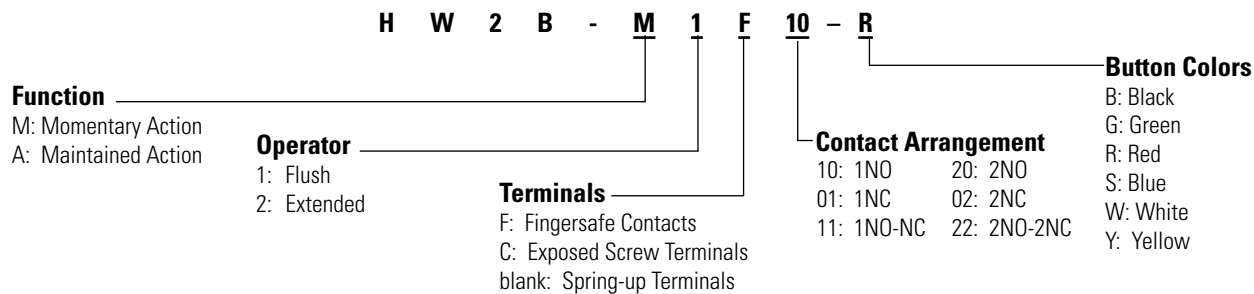

Non-Illuminated Square Pushbuttons (Replacement Parts)

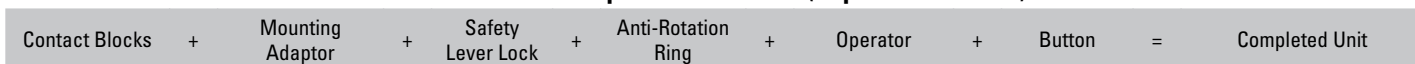

Contact Blocks

| Style | Contacts | 1NO | 1NC |
|-------|----------------------------|----------------------|----------------------|
| | Standard Fingersafe (IP20) | HW-F10 | HW-F01 |
| | | HW-F10R (early make) | HW-F01R (late break) |
| | Spring-Up Terminal | HW-G10 | HW-G01 |
| | | HW-G10R (early make) | HW-G01R (late break) |
| | Exposed Screw Terminal | HW-C10 | HW-C01 |
| | | HW-C10R (early make) | HW-C01R (late break) |
| | Dummy Block | TW-DB | |

Contact Block Mounting Adaptor

| Style | Part Number |
|-------|-------------|
| | HW-CB2C |

- 1. Used to mount contact blocks to operator.
- 2. IDEC strongly recommends using the safety lever lock to prevent heavy vibration or maintenance personnel from inadvertently unlocking contacts.

Safety Lever Lock

| Style | Part Number |
|-------|-------------|
| | HW9Z-LS |

Anti-Rotation Ring

| Appearance | Part Number |
|------------|-------------|
| | HW9Z-RL |

- Use with notched panel cutout to prevent unit rotation.

Operators

| Style | Plastic Bezel |
|---------------------------|-----------------------|
| Square Flush Extended | Momentary HW2B-M0 |
| | Maintained HW2B-A0 |

- 2. For nameplates and accessories, see pages 596 and 599.
- 3. For dimensions, see page 601.

Buttons

| Style | Part Number |
|---------------------|-------------|
| Square Flush | HW2A-B1-⓪ |
| Square Extended | HW2A-B2-⓪ |

- 1. In place of ⓪, specify the Button Color Code from table.

⓪ Button Color Code

| Color | Code | Color | Code |
|-------|------|--------|------|
| Black | B | Blue | S |
| Green | G | White | W |
| Red | R | Yellow | Y |

Part Number Structure

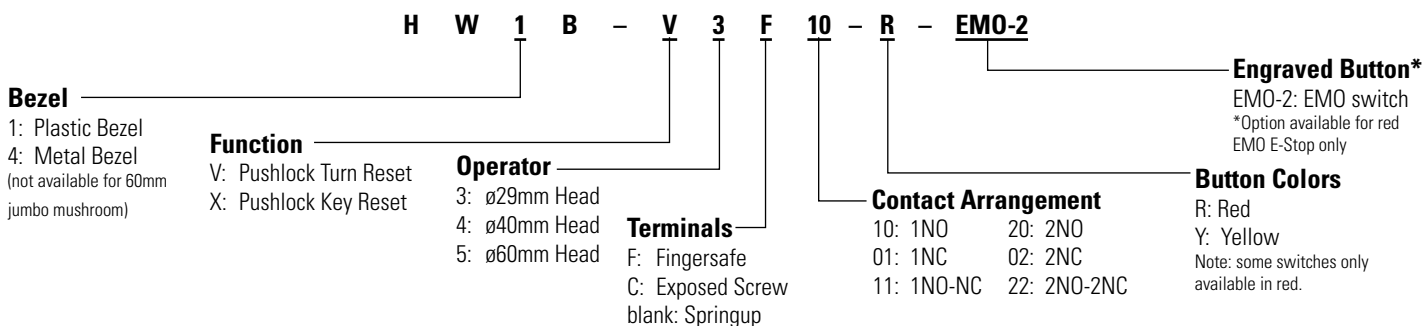

Non-Illuminated E-Stop Pushbuttons (Replacement Parts)

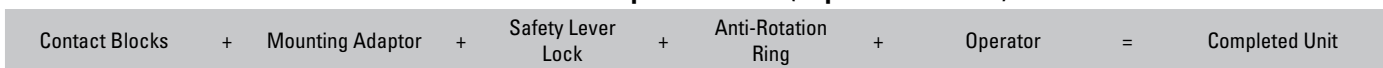

Contact Blocks

| Style | Contacts | 1NO | 1NC |
|-------|----------------------------|----------------------|----------------------|
| | Standard Fingersafe (IP20) | HW-F10 | HW-F01 |
| | | HW-F10R (early make) | HW-F01R (late break) |
| | Spring-Up Terminal | HW-G10 | HW-G01 |
| | | HW-G10R (early make) | HW-G01R (late break) |
| | Exposed Screw Terminal | HW-C10 | HW-C01 |
| | | HW-C10R (early make) | HW-C01R (late break) |
| | Dummy Block | TW-DB | |

Safety Lever Lock

| Style | Part Number |
|-------|-------------|
| | HW9Z-LS |

Anti-Rotation Ring

| Appearance | Part Number |
|------------|-------------|
| | HW9Z-RL |

Use with notched panel cutout to prevent unit rotation.

Operators

| Style | Plastic | | Metal |
|-----------------------------------------|---------|----------------|----------------|
| ø29mm Head Pushlock Turn Reset | red | HW1B-V3R | HW4B-V3R |
| | yellow | HW1B-V3Y | HW4B-V3Y |
| ø40mm Head Pushlock Turn Reset | red | HW1B-V4R | HW4B-V4R |
| | yellow | HW1B-V4Y | HW4B-V4Y |
| ø40mm Head EMO Pushlock Turn Reset* | | HW1B-V4R-EMO-2 | HW4B-V4R-EMO-2 |
| ø40mm Head Pushlock Key Reset* | | HW1B-X4R | HW4B-X4R |
| ø60mm Head Pushlock Turn Reset* | | HW1B-V5R | - |

1. *Available in red only.
2. All E-Stop buttons are not removable from the operator.

Contact Block Mounting Adaptor

| Style | Part Number |
|-------|-------------|
| | HW-CB2C |

- 1. Used to mount contact blocks to operator.
- 2. IDEC strongly recommends using the safety lever lock to prevent heavy vibration or maintenance personnel from inadvertently unlocking contacts.