



Automation for a Changing World

Delta Human Machine Interface DOP-B Series



www.delta.com.tw/ia

 **DELTA**
Smarter. Greener. Together.

One Touch Gives You Limitless Possibilities

Meets Customer Needs. Satisfies a Variety of Applications. Provides Multiple Functions.

Energy Saving and Environmental Automation

All models are equipped with LED backlights which provide energy-efficient lighting that is made without mercury, reduces energy use and CO2 emissions, and protects the environment.

A Wide Range of Options

Three serial communication interfaces (RS-232/RS-485/RS-422), USB disk, Ethernet, audio output, SD card and more are supported for various applications.

Powerful Controller Drivers Support

Not just Delta industrial automation products, but more than 30 brands, and over 100 models of PLCs or controllers can be connected for effortless communication and versatile operation.

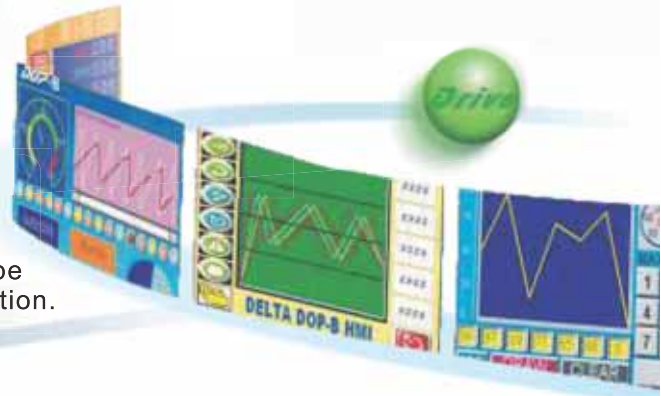

Motion

Best Performance

Human M

Beautiful Display



Beneficial Features

Capabilities with HMI

Functions. Creates the Ultimate FA Equipment.

High Quality and Full-Color Display

A full 65,536-color display is available on all models. With a whole new 2D drawing technique, the screen resolution is enhanced for more realistic images and for more colorful and vivid displays.



Specifications

B03 High Resolution Widescreen

Model Name	Display Size	Display Type	Resolution	ROM	Ethernet	USB Host	USB Client	Memory Card	Audio Output
DOP-B03S211	4.3-inch	65536 Colors TFT	480x272	128MB	N/A	v1.1 * 1	V2.0 * 1	N/A	N/A
DOP-B03E211	4.3-inch	65536 Colors TFT	480x272	128MB	10/100 Base-T	v1.1 * 1	V2.0 * 1	N/A	N/A

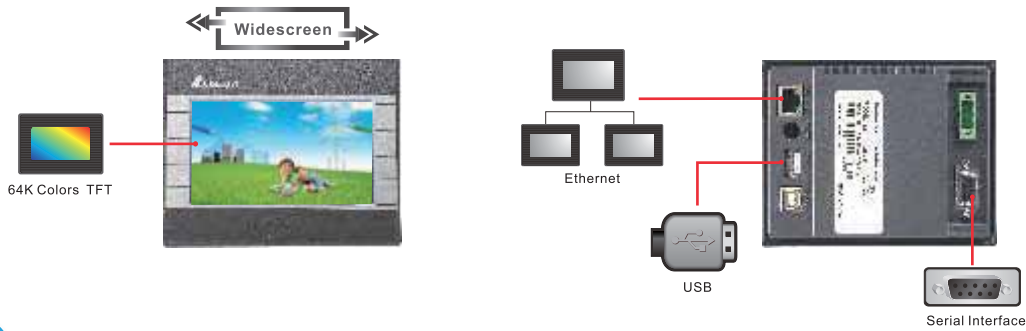

B05 Standard

Model Name	Display Size	Display Type	Resolution	ROM	Ethernet	USB Host	USB Client	Memory Card	Audio Output
DOP-B05S111	5.6-inch	65536 Colors TFT	320x234	128 MB	N/A	v1.1 * 1	v2.0 * 1	N/A	N/A

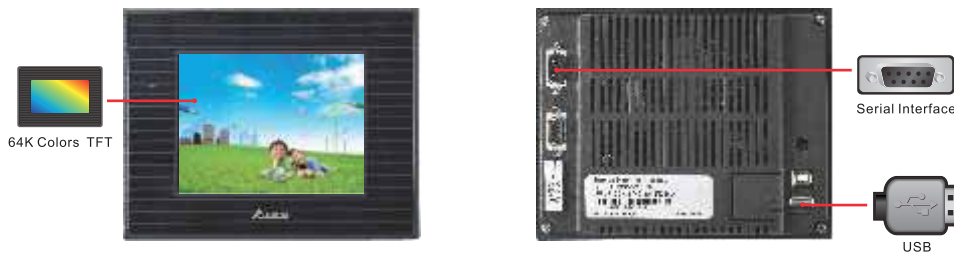

B07 High Resolution Widescreen

Model Name	Display Size	Display Type	Resolution	ROM	Ethernet	USB Host	USB Client	Memory Card	Audio Output	Function Key	Delta Professional Integration Function
DOP-B07S411	7-inch	65536 Colors TFT	800x480	128MB	N/A	v1.1 * 1	V2.0 * 1	N/A	N/A	N/A	N/A
DOP-B07S401K	7-inch	65536 Colors TFT	800x480	128MB	N/A	v1.1 * 1	V2.0 * 1	N/A	N/A	8	N/A
DOP-B07S411K	7-inch	65536 Colors TFT	800x480	128MB	N/A	v1.1 * 1	V2.0 * 1	N/A	N/A	8	N/A
DOP-B07S415	7-inch	65536 Colors TFT	800x480	128MB	N/A	v1.1 * 1	V2.0 * 1	SD	N/A	N/A	N/A
DOP-B07E415	7-inch	65536 Colors TFT	800x480	128MB	10/100 Base-T	v1.1 * 1	V2.0 * 1	SD	YES	N/A	N/A
DOP-B07PS415	7-inch	65536 Colors TFT	800x480	128MB	N/A	v1.1 * 1	V2.0 * 1	SD	N/A	N/A	YES

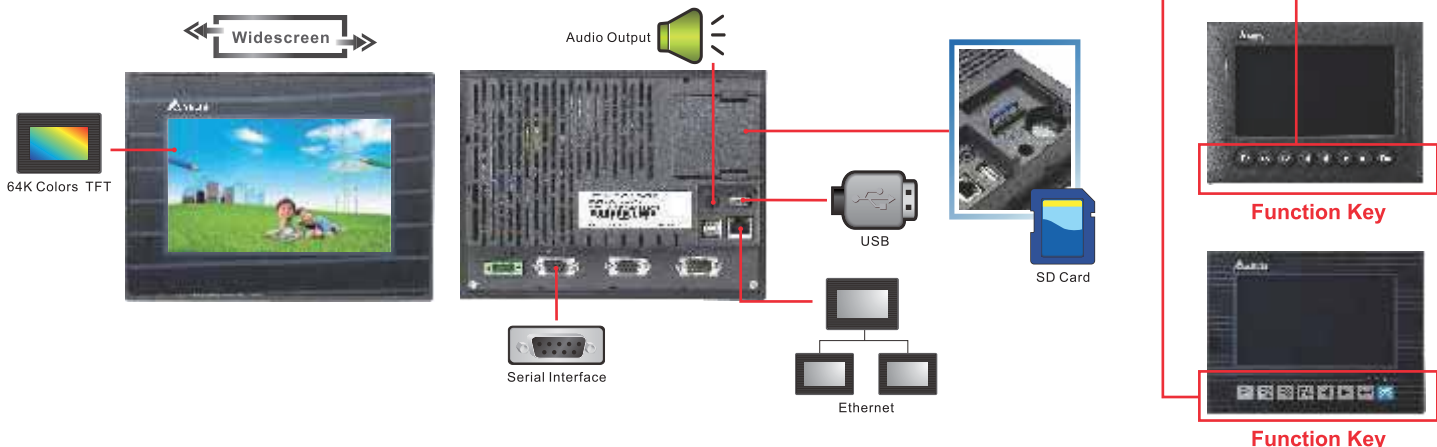

B07 High Resolution

Model Name	Display Size	Display Type	Resolution	ROM	Ethernet	USB Host	USB Client	Memory Card	Audio Output	Delta Professional Integration Function
DOP-B07S515	7-inch	65536 Colors TFT	800x600	128MB	N/A	v1.1 * 1	V2.0 * 1	SD	N/A	N/A
DOP-B07E515	7-inch	65536 Colors TFT	800x600	128MB	10/100 Base-T	v1.1 * 1	V2.0 * 1	SD	YES	N/A
DOP-B07PS515	7-inch	65536 Colors TFT	800x600	128MB	N/A	v1.1 * 1	V2.0 * 1	SD	N/A	YES

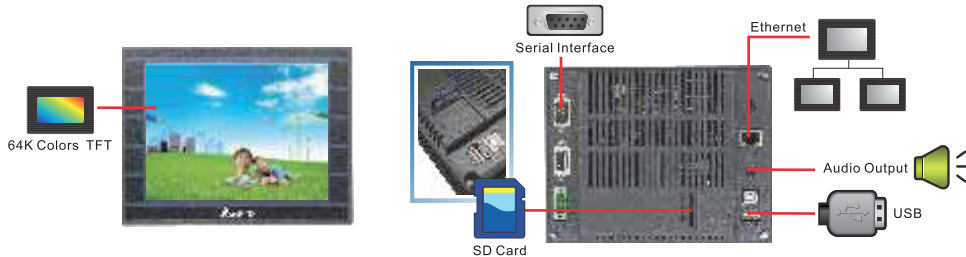

B08 High Resolution

Model Name	Display Size	Display Type	Resolution	ROM	Ethernet	USB Host	USB Client	Memory Card	Audio Output
DOP-B08S515	8-inch	65536 Colors TFT	800x600	128MB	N/A	v1.1 * 1	V2.0 * 1	SD	N/A
DOP-B08E515	8-inch	65536 Colors TFT	800x600	128MB	10/100 Base-T	v1.1 * 1	V2.0 * 1	SD	YES

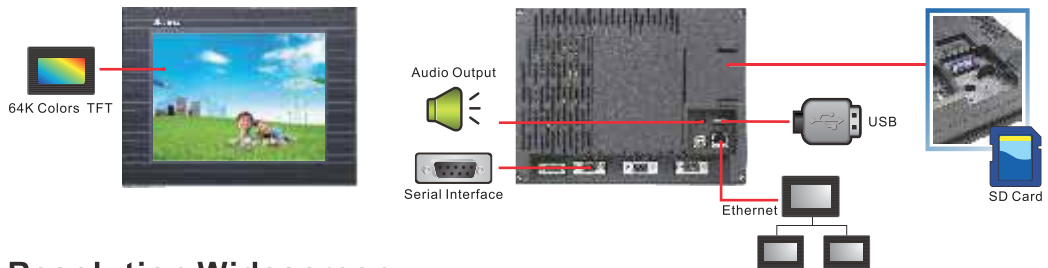

B10 High Resolution Widescreen

Model Name	Display Size	Display Type	Resolution	ROM	Ethernet	USB Host	USB Client	Memory Card	Audio Output
DOP-B10S411	10.1-inch	65536 Colors TFT	800x480	128MB	N/A	v1.1 * 1	V2.0 * 1	N/A	N/A
DOP-B10S615	10.1-inch	65536 Colors TFT	1024x600	128MB	N/A	v1.1 * 1	V2.0 * 1	SD	N/A
DOP-B10E615	10.1-inch	65536 Colors TFT	1024x600	128MB	10/100 Base-T	v1.1 * 1	V2.0 * 1	SD	YES

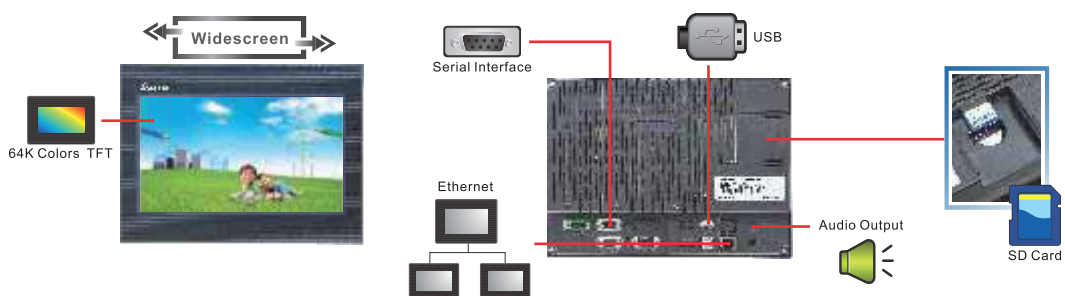

B10 High Resolution

Model Name	Display Size	Display Type	Resolution	ROM	Ethernet	USB Host	USB Client	Memory Card	Audio Output
DOP-B10S511	10.4-inch	65536 Colors TFT	800x600	128MB	N/A	v1.1 * 1	V2.0 * 1	N/A	N/A
DOP-B10E515	10.4-inch	65536 Colors TFT	800x600	128MB	10/100 Base-T	v1.1 * 1	V2.0 * 1	SD	YES

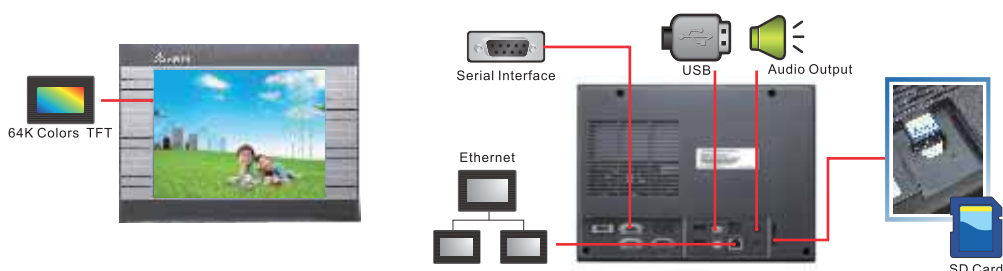



High Quality Display



65,536-color high quality TFT display offers more realistic and vivid images to capture and visualize system and manufacturing processes more quickly.

Audio Output Interface



Supports built-in amplified speaker using 3.5mm stereo mini jack

- In case of errors, an alarm alerts users via an audio message in real time.

▶ As the broadcast of alarms is triggered by the corresponding bit, the alarm messages can be played and output in different sound files by setting values of word registers.



D100	Sound Files	Audio Messages
1	A.wav	Overcurrent
2	B.wav	Overvoltage
3	C.wav	Overload

Supports Various Peripherals via USB Hub

Slave (USB-type B)

! Compatible with Windows Vista / Windows 7



Screen data can be transferred rapidly via USB connection.



Up to 480Mbps high-speed data transfer via USB v2.0



PLC Programming Software: WPLSoft

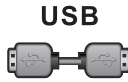
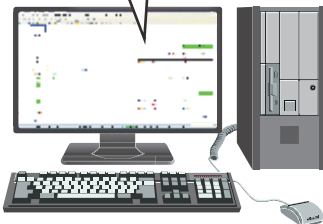

USB



RS-232



*Supports Delta DVP series PLC only.

Using bypass function, enable monitoring functions and modify PLC programs directly via USB connection.

Master (USB-type A)

Various peripherals can be connected via USB Hub.



USB Hub

Up to 5 peripherals can be connected simultaneously.



Keyboard

Mouse

USB Flash Drive

Barcode Reader

Printer

Supports printers compatible with PictBridge.

SD Card / USB Disk Versatile Storage Interface

- Exploiting the convenience of SD card and USB disk, screen data transfer and collection can be quickly performed and the storage capacities of HMI can be easily increased. No need to worry about data capacity of excessive history and recipe data.
- SD card and USB disk are in FAT32 format, fully compatible with Microsoft Windows and allow filenames that exceed eight characters in length.



The recipe data can be saved in CSV format and easily edited on an external PC in Excel to effectively save PLC memory.



History and alarm information can also be saved in CSV format and stored to the SD card / USB disk.

- Multiple project screen data can be saved in SD card / USB disk simultaneously and transferred to HMI. No need to connect to PC.
- The data saved in SD card / USB disk can be encrypted and the number of copies can be limited to protect the programs from unauthorized use.

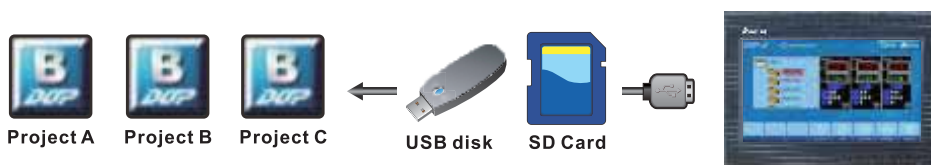

- PLC ladder diagrams can be transferred and backup via SD card / USB disk even in a location where an external PC is not available.
- SD card / USB disk are capable of storing several PLC ladder diagrams.

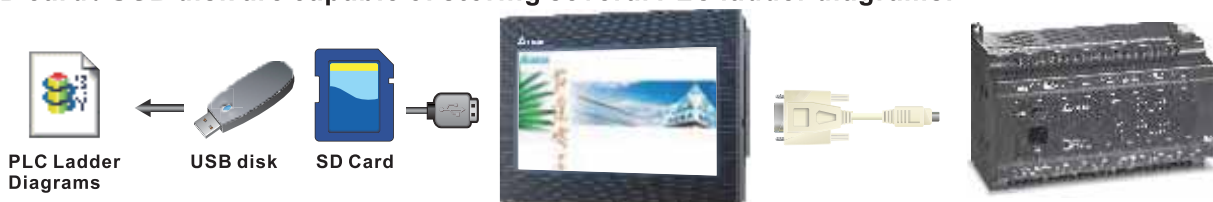

Support Delta DVP series PLC only.



Multilingual Display

Up to 16 languages are available. No need to redesign the screen data! A benefit for marketing the equipment to manufacturers and end users around the world.

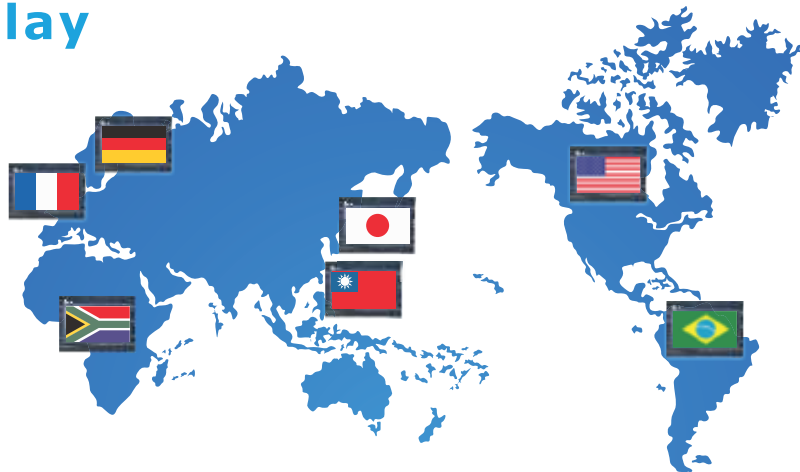

Multilingual editing on a PC in Excel

	D	E	F	G
1	Chinese	English	Japanese	Spanish
2	星期日	SUN	日曜日	Domingo
3	星期一	MON	月曜日	Lunes
4	星期二	TUE	火曜日	Martes
5	星期三	WED	水曜日	Miércoles
6	星期四	THR	木曜日	Jueves
7	星期五	FRI	金曜日	Viernes
8	星期六	SAT	土曜日	Sábado

Password Settings

Provide 8 levels of passwords to set user security to prevent improper use. Only the security level that is equal to or higher than the current setting can use the element.

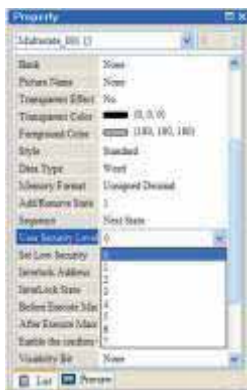

Element Invisible Function

The element on the screen can be hidden by triggering the corresponding bit.



Provides Diverse Communication Interfaces

Easy to communicate with more than 30 brands of PLCs/Controllers

All DOP-B series models support RS-232/485/422 communication interfaces and over 20 different PLC/Controller drivers. With the aid of an Ethernet interface, it is possible to use four communication interfaces at the same time, easily connecting to various industrial automation devices for a complete communication network link managed by Delta's new DOP-B series.

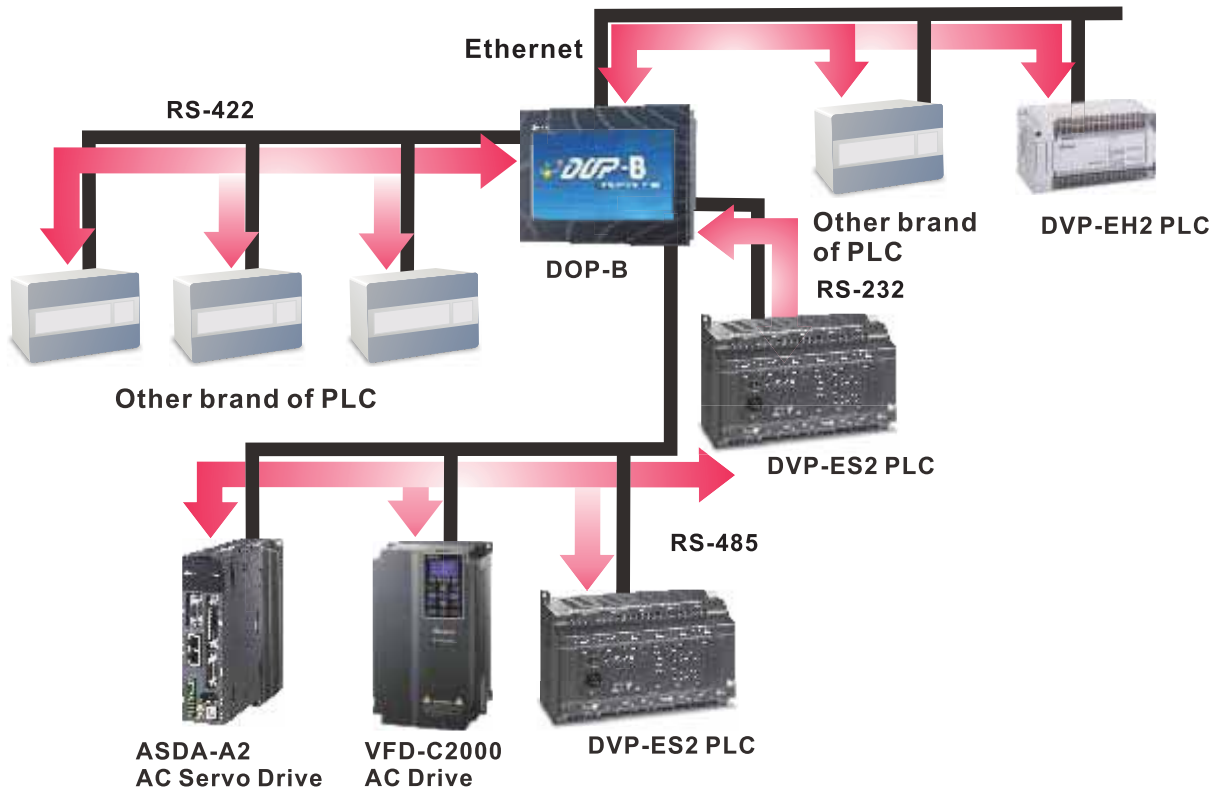

Ethernet Ubiquitous High Speed Communication

Ethernet Upload and Download

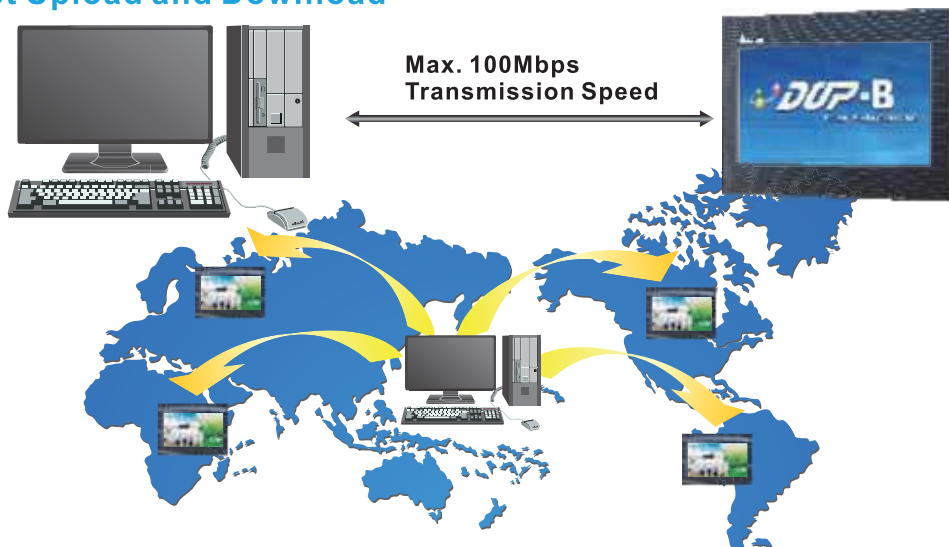

Easy to maintain and upgrade programs no matter where you are in the world.

Best Solution for Network Monitoring

Using an Ethernet connection can easily establish an N:N communication link and create the desired communication network according to different application requirements.

The DOP-B series HMI can use the IFD9506 Ethernet communication module, which is able to switch Ethernet and RS-485 interfaces quickly, to connect Delta's AC servo drive, AC motor drive, temperature controller and other industrial automation products via the Ethernet and control the entire network for a complete and ultimate network monitoring solution.

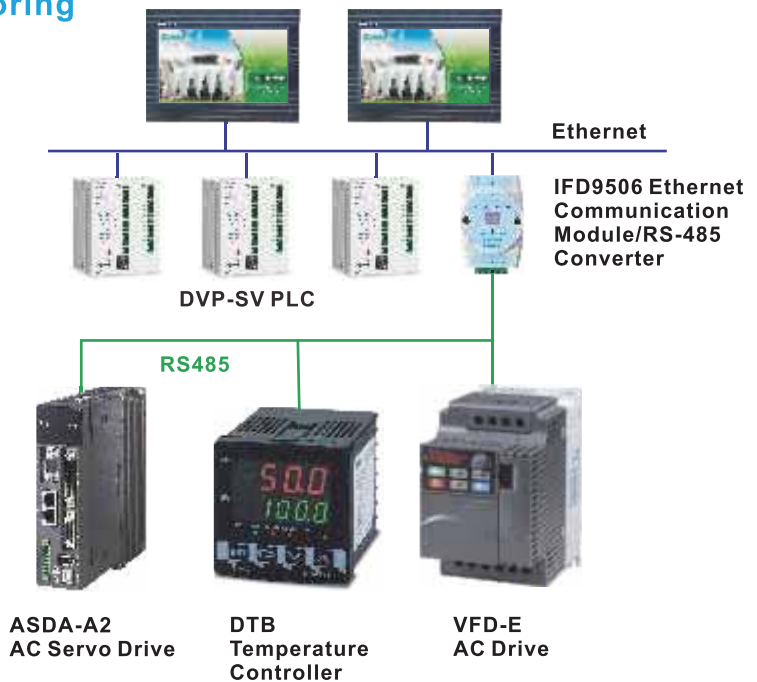

Delta Professional Integration Function: Electronic Cam (E-Cam) Curve Table

- Supports ASDA-A2 series servo drives
- A personal computer is not required. Electronic cam curves can be generated on HMI and downloaded to the ASDA-A2 series servo drive directly.



Supports E-Cam table macro for making E-Cam curve on HMI

- Auto rotary shear with sealing zone
- Indirect printing
- Auto rotary shear – cos compensation

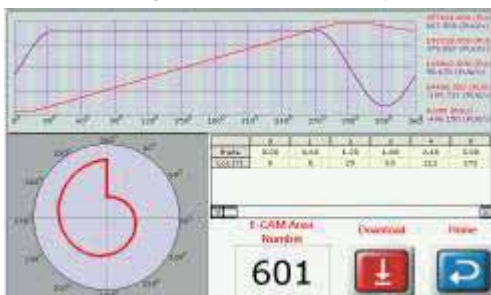

Supports cubic curve manual creation

File Name	Theta	Acc	Const. Speed	Type
20120307	0	25	90	Cubic Curve
20120221_152917	0	55	0	Const. Acc
20120217_184259	180	247	360	Cubic Curve
		99	0	Const. Speed
				N/A

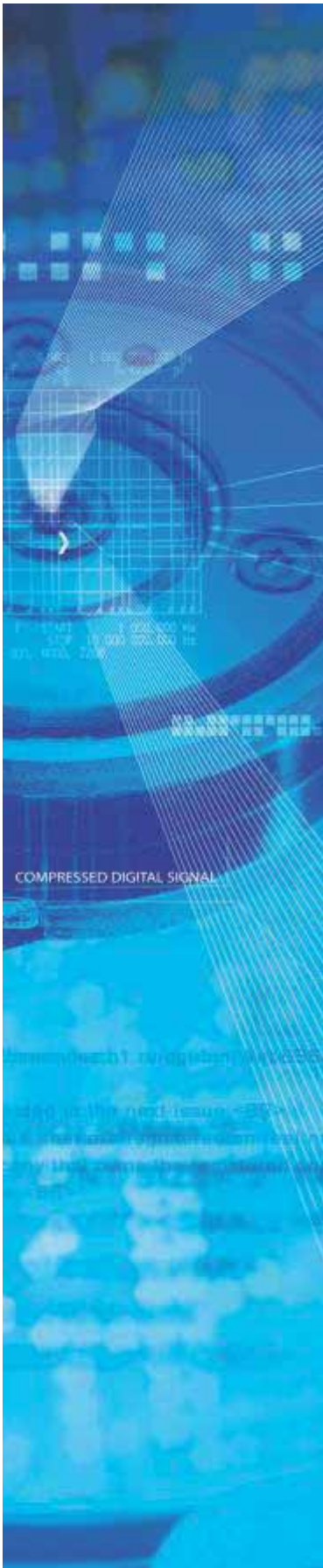

DOPSoft

The all new and upgraded configuration software provides a user-friendly operator interface. Make editing easier than ever of design.

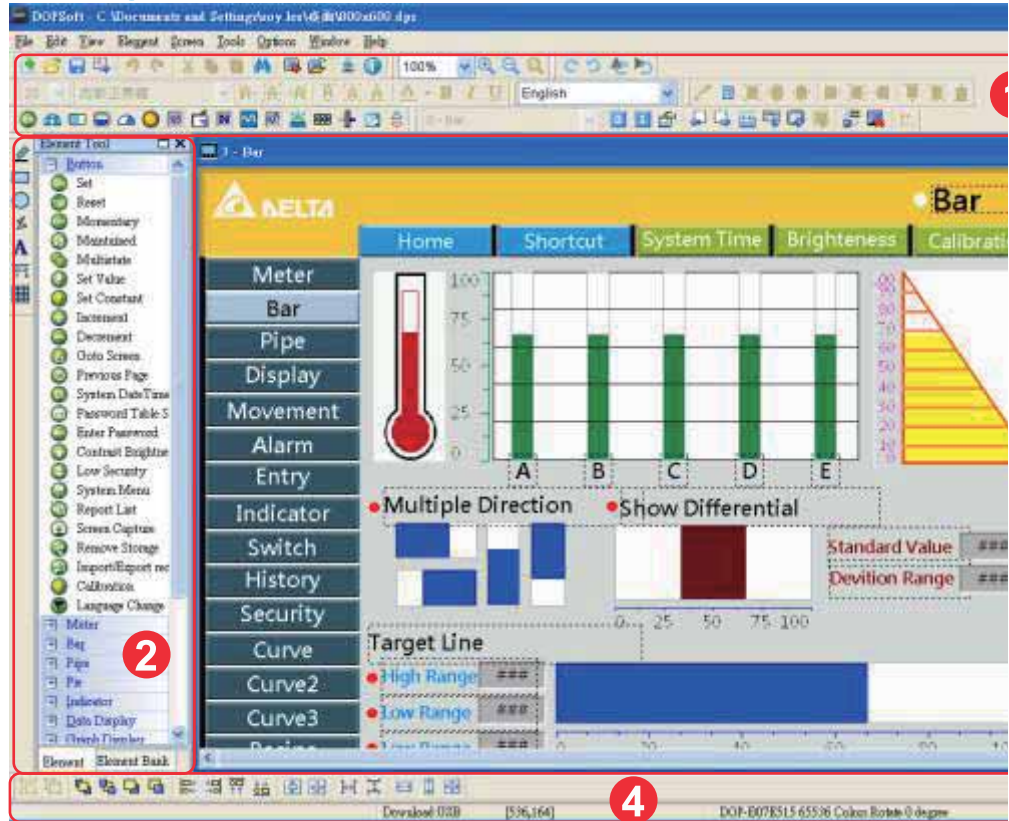

1) Toolbar

Actions such as edit, save, upload and compile can be executed easily just by clicking the attractive and easy-to-see icons on the toolbar.

2) Element Tool Window

The Element Tool window provides a wide variety of element icons for selection. Use the mouse to select the desired element icon and drag it onto the work place to create a new element.

3) Output Window

The Output Window displays all the editing actions and output messages when the compile function is enabled. Once an error occurs, the error messages are displayed in Output Window as well.

4) Layout Toolbar

The Layout Toolbar offers Bring to Front, Send to Bottom, Align, Across/Down Space Evenly, Make Same Size and other functions for the benefit of creating intricate and beautiful elements.

5) Property Table

The Property Table displays the element property settings for each element.

Picture

Newly designed attractive elements



complete functions and a
er with a whole new level

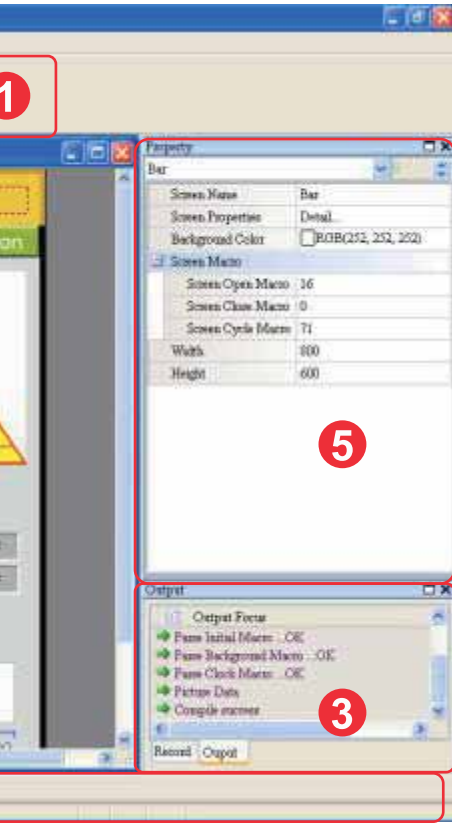

Convenient Screen Data Conversion

Compatible with the existing Screen Editor software, the project file created by Screen Editor can be easily upgraded and converted to DOPSoft format.

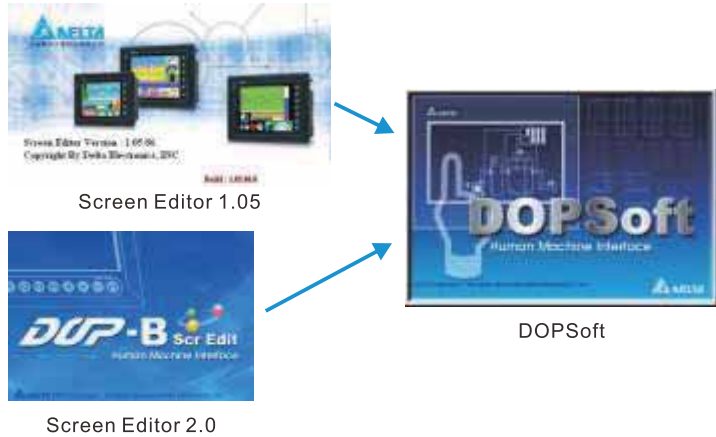

The screen data can be converted to different models even if the display size is not the same. The same project can be applied on different models.



* After the screen data is converted, it still needs to confirm the element position, text size and other settings.

re Bank

igned picture bank offers more colorful and
elements.



Minimum System Requirements of DOPSoft

Hardware / Software	System Requirements
CPU	Pentium4 1.6GHz or greater is recommended
Memory	2G MB and above is recommended
Hard Disk	Capacity: 400MB and above
Monitor	Supports resolution: 800 x 600 or higher full-color display.
Printer	Printer compatible with Windows 2000 Windows XP / Windows Vista / Windows 7
Operating System	Windows 2000 / Windows XP Windows Vista / Windows 7

* Users can download the DOPSoft configuration software and the user manual at Delta's website via the following link: <http://www.delta.com.tw/ia>

Solution for Constructing a Network between Office and Production Site via Ethernet

eServer Data Collection Software

eServer lets you transfer production information and history data directly from production site to a PC in the office via Ethernet.

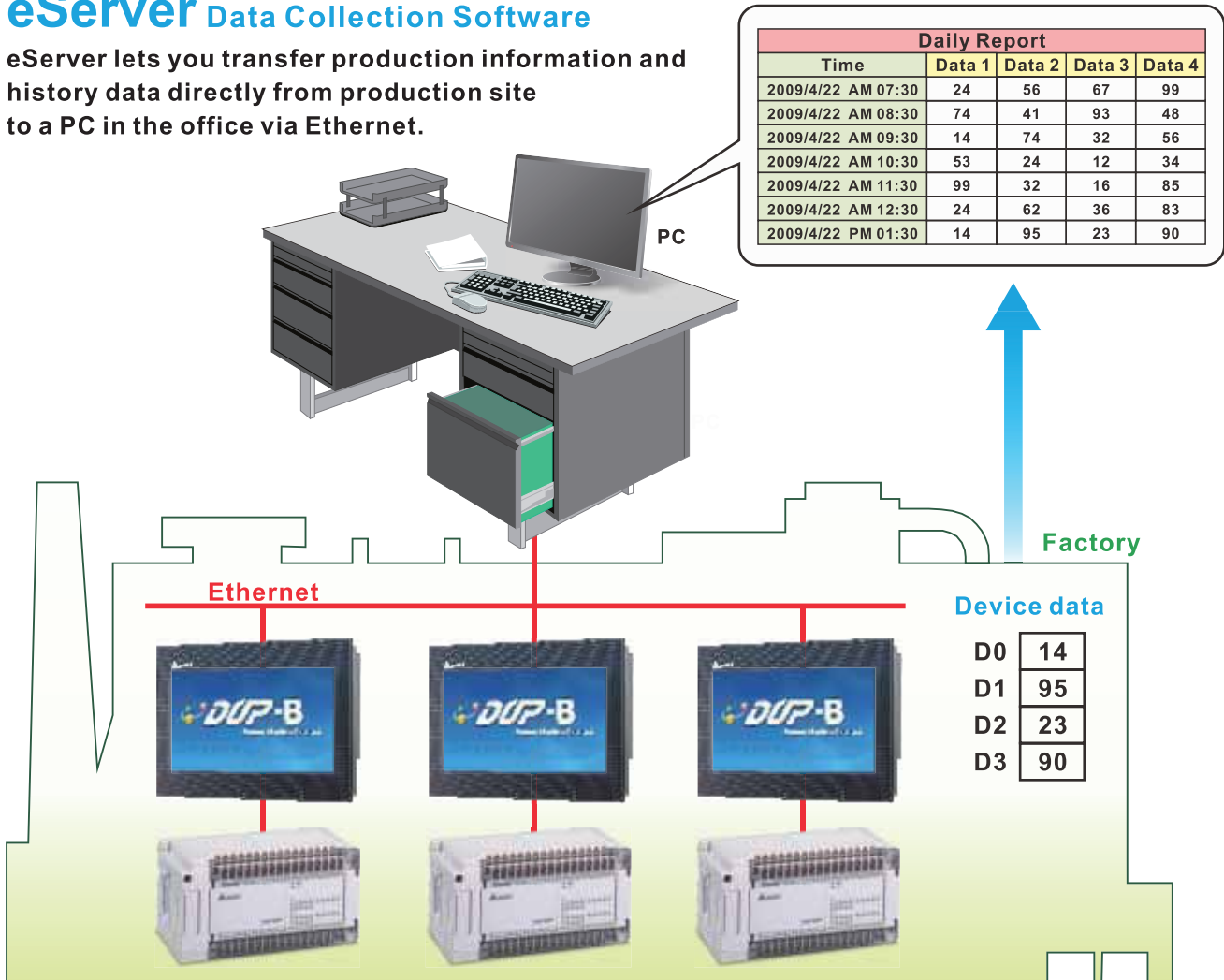

1) Excel Sampling Data

- Collected data can be saved in user-defined Excel files according to purpose and to easily create production reports.
- If the formulas in the Excel file are set in advance, the production data, i.e. defective rate, average working hours and capacity utilization rate, and more can be calculated in real time while production data is recorded.
- Production data can be saved in daily reports, weekly reports and monthly reports, and more automatically under different settings.

2) Database Sampling Data

- Users can access any database via ODBC (Open Database Connectivity) interface.

3) Recipe Data Transfer

- Users can transfer and backup the recipe data via eServer easily.

eRemote Remote Control Software

eRemote lets you view and monitor the same screen shown on the HMI at the production site, and control the manufacturing process via Ethernet. No matter where you are, remote control is easily accomplished.

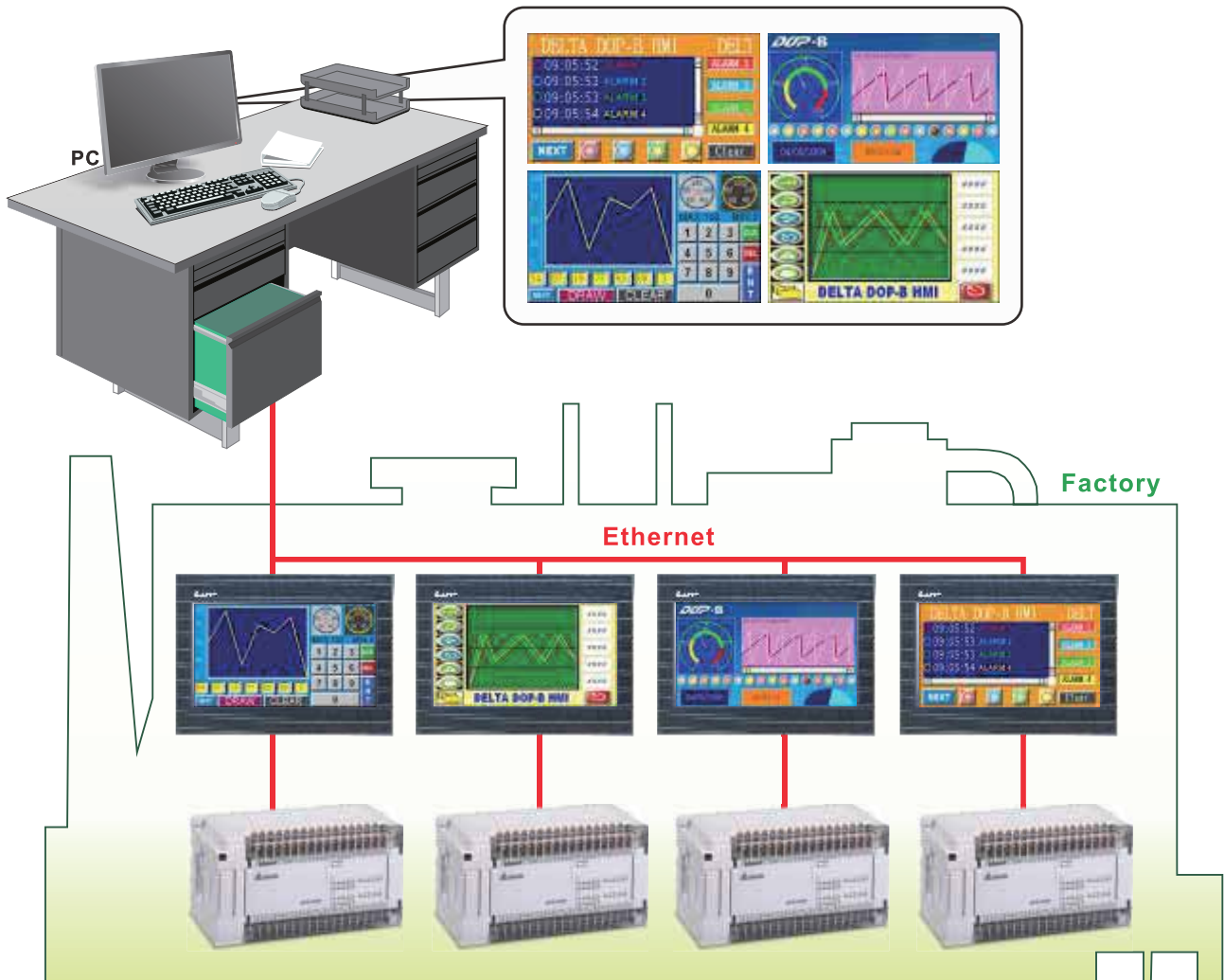

Minimum System Requirements for eServer / eRemote

Hardware / Software	System Requirements
CPU	Pentium 4, 1.6GHz or greater is recommended
Memory	2G MB and above is recommended
Hard Disk	Capacity: 100MB and above
Monitor	Supports resolution: 1024 x 768 or higher full-color display.
Printer	Printer compatible with Windows 2000 / Windows XP / Windows Vista / Windows 7
Operating System	Windows 2000 / Windows XP / Windows Vista / Windows 7

* Users can download the eServer / eRemote software and the user manual at Delta's website via the following link:
<http://www.delta.com.tw/ia>



Dimensions Units: mm (inches)

● DOP-B03S(E)211

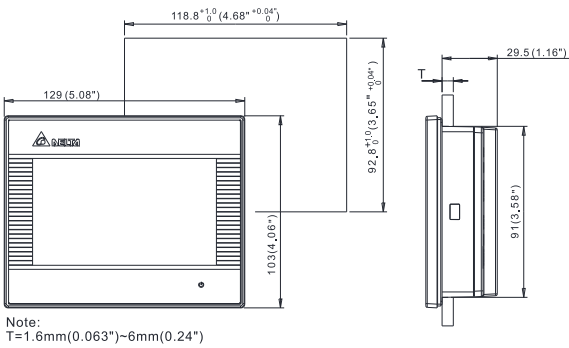

● DOP-B05S111

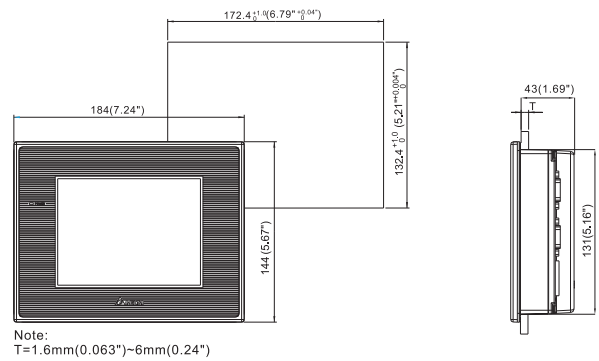

● DOP-B07S401K / DOP-B07S411(K) DOP-B07S(E)415 / DOP-B07PS415

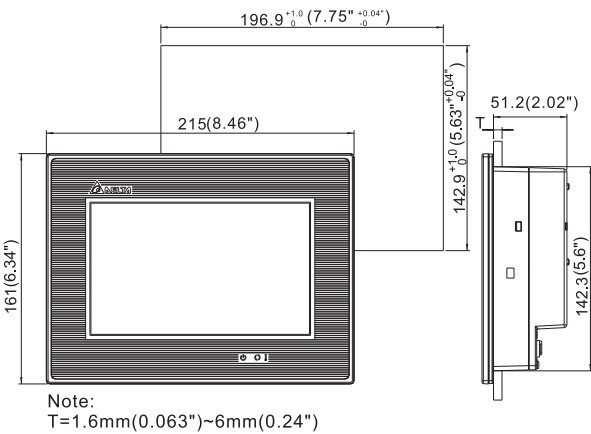

● DOP-B07S(E)515 / DOP-B07PS515

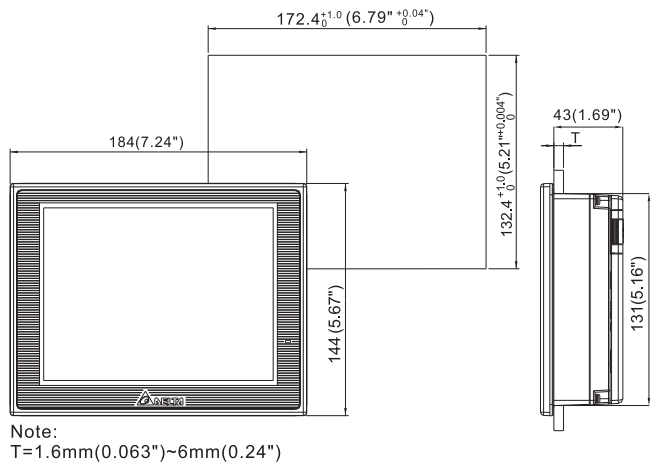

Optional Accessories

Model Name	Description
DOP-CA232DP	DOP-CA232DP: RS-232 Communication Cable for DVP Series PLC (Female Socket)
DVPACAB2A30	DVPACAB2A30: RS-232 Communication Cable for DVP Series PLC (Male Socket)
DOP-CAUSBAB	DOP-CAUSBAB: USB Communication Cable



● **DOP-B08S(E)515**

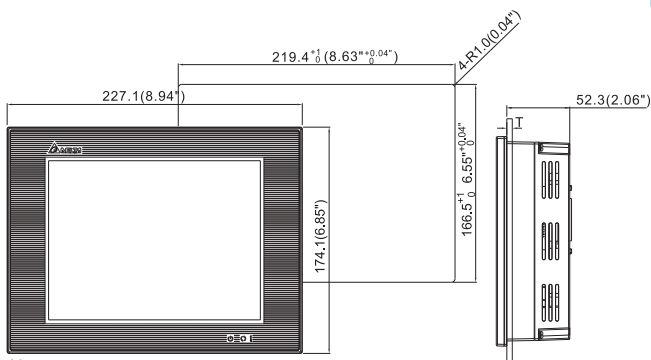

Note:
T=1.6mm(0.06")~5.0mm(0.19")

● **DOP-B10S411**
DOP-B10S(E)615

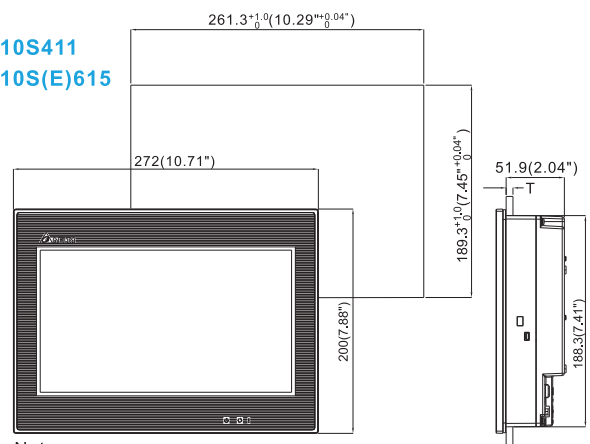

Note:
T=1.6mm(0.063")~6mm(0.24")

● **DOP-B10S511**
DOP-B10E515

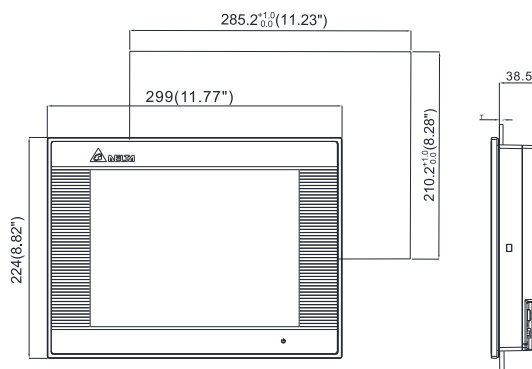

Note:
T=1.6mm(0.063")~6mm(0.24")

Ordering Information

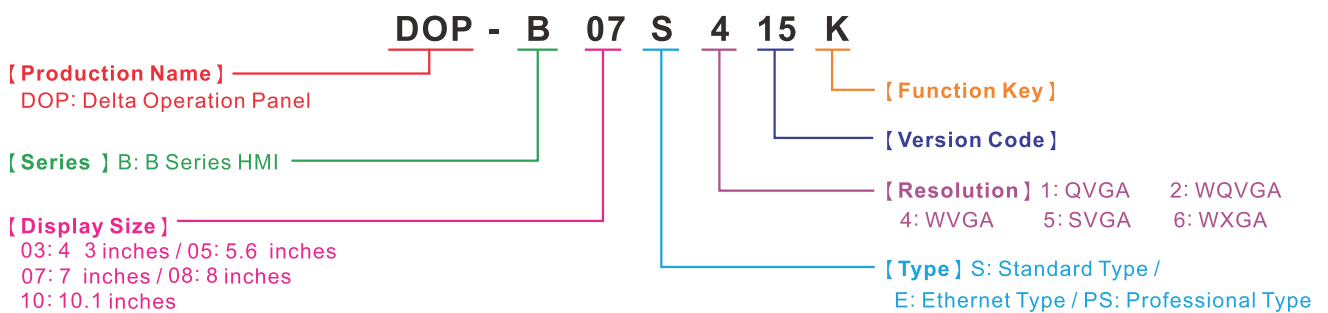

Specifications

MODEL		DOP-B03S211	DOP-B03E211	DOP-B05S111	DOP-B07S411	DOP-B07S401K DOP-B07S411K	DOP-B07S415 DOP-B07PS415	DOP-B07E415	
LCD MODULE	Display Type	4.3" TFT LCD (65536 colors)		5.6" TFT LCD (65536 colors)	7" Widescreen TFT LCD (65536 colors)				
	Resolution	480 x 272 pixels		320 x 234 pixels	800 x 480 pixels				
	Backlight	LED Back Light (less than 20,000 hours half-life at 25°C) ^(Note 1)							
	Display Size	95.04 x 53.856mm	113.28 x 84.70mm		154.08 x 85.92mm	152.4 x 91.44mm			
Operating System		Delta Real Time OS							
MCU		32-bit RISC Micro-controller							
Flash ROM		Flash ROM 128 MB(OS System: 30MB / Backup: 16MB / User Application: 82MB)							
SDRAM		64Mbytes							
Backup Memory		16Mbytes							
Sound Effect Output	Buzzer	Multi-Tone Frequency (2K ~ 4K Hz) / 85dB							
	AUX	N/A	N/A	N/A	N/A	N/A	N/A	Stereo output	
Ethernet Interface		N/A	IEEE 802.3, IEEE 802.3u 10/100 Mbps Auto-sensing (has built-in isolated power circuit) ^(Note 3)	N/A	N/A	N/A	N/A	IEEE 802.3, IEEE 802.3u 10/100 Mbps Auto-sensing (has built-in isolated power circuit) ^(Note 3)	
Memory Card		N/A	N/A	N/A	N/A	N/A	SD card (support SDHC)		
USB		1 USB Host ^(Note 2) Ver 1.1 / 1 USB Client Ver 2.0							
Serial COM Port	COM1	RS-232 (Supports hardware flow control) / RS-485		RS-232 (supports hardware flow control)					
	COM2	RS-422 / RS-485		RS-232 / RS-485			RS-232 / RS-422 RS-485	RS-232 / RS-422 RS-485 (has built-in isolated power circuit) ^(Note 3)	
	COM3	N/A		RS-422 / RS-485			RS-232 / RS-422 RS-485	RS-232 / RS-422 RS-485 (has built-in isolated power circuit) ^(Note 3)	
Function Key		N/A			8	N/A			
Perpetual Calendar (RTC)		Built-in							
Cooling Method		Natural air circulation							
Safety Approval		CE / UL ^(Note 4) / KCC ^(Note 4)							
Waterproof Degree		IP65 / NEMA4							
Operation Voltage ^(Note 5)		DC +24V(-10% ~ +15%) (please use isolated power supply)							DC +24V (-10% ~ +15%) (has built-in isolated power circuit) ^(Note 3)
Voltage Endurance		AC500V for 1 minute (between charging DC24 terminal and FG terminals)							
Power Consumption ^(Note 5)		2.64W	2.64W	3.0W	4W	4W	5W	7.5W	
Backup Battery		3V lithium battery CR2032 x 1							
Backup Battery Life		It depends on the temperature used and the conditions of usage, about 3 years or more at 25°C							
Operation Temp		0°C ~ 50°C							
Storage Temp		-20°C ~ +60°C							
Ambient Humidity		10% ~ 90% RH [0 ~ 40°C], 10% ~ 55% RH [41 ~ 50°C], Pollution Degree 2							
Vibration / Shock		IEC 61131-2 compliant 5Hz ~ 8.3Hz = Continuous: 3.5mm, 8.3Hz ~ 150Hz = Continuous: 1.0g IEC 60068-2-27 compliant 15g peak for 11 ms duration, X, Y, Z directions for 6 times							
Dimensions (W) x (H) x (D) mm		129 x 103 x 39	129 x 103 x 39	184 x 144 x 50	215 x 161 x 50	215 x 161 x 50	215 x 161 x 50	215 x 161 x 50	
Panel Cutout (W) x (H) mm		118.8x 92.8	118.8x 92.8	172.4 x 132.4	196.9 x 142.9	196.9 x 142.9	196.9 x 142.9	196.9 x 142.9	
Weight		Approx. 230g	Approx. 264g	Approx. 670g	Approx. 820g	Approx. 820g	Approx. 970g	Approx. 970g	

1) The half-life of backlight is defined as original luminance being reduced by 50% when the maximum driving current is supplied to HMI.

2) USB Host port can provide up to 5V/500mA of power.

3) The isolated power circuit can withstand a 1500V voltage peak for 1 minute.

4) Some models are in the process of application for UL and KCC certification. For more information, please consult our distributors.

5) The value of the power consumption indicates the electrical power consumed by HMI with no peripheral devices connected. To ensure normal operation, it is recommended using a power supply with a capacity 1.5 ~ 2 times the value of the power consumption.

6) Users can download the DOPSoft, the program editor of Delta HMI products and the user manual via the following link:

<http://www.delta.com.tw/ia>

7) The content of this catalogue may be revised without prior notice. Please consult our distributors or download the most updated version at

<http://www.delta.com.tw/ia>

DOP-B07S515	DOP-B07PS515	DOP-B07E515	DOP-B08S515	DOP-B08E515	DOP-B10S511	DOP-B10E515	DOP-B10S411	DOP-B10S615	DOP-B10E615
7" TFT LCD (65536 colors)			8" TFT LCD (65536 colors)		10.4" TFT LCD (65536 colors)		10.1" Widescreen TFT LCD (65536 colors)		
800 x 600 pixels							800 x 480 pixels	1024 x 600 pixels	
LED Back Light (less than 10,000 hours half-life at 25°C) ^(Note 1)									
141 x 105.75mm			162 x 121.5mm		211.2 x 158.4mm		219.6 x 131.76mm	226 x 128.7mm	
Delta Real Time OS									
32-bit RISC Micro-controller									
Flash ROM 128 MB(OS System: 30MB / Backup: 16MB / User Application: 82MB)									
64Mbytes									
16Mbytes									
Multi-Tone Frequency (2K ~ 4K Hz) / 85dB									
N/A	N/A	Stereo output	N/A	Stereo output	N/A	Stereo output	N/A	N/A	Stereo output
N/A	N/A	IEEE 802.3, IEEE 802.3u	N/A	IEEE 802.3, IEEE 802.3u	N/A	IEEE 802.3, IEEE 802.3u	N/A	N/A	IEEE 802.3, IEEE 802.3u
		10/100 Mbps Auto-sensing (has built-in isolated power circuit) ^(Note 3)		10/100 Mbps Auto-sensing (has built-in isolated power circuit) ^(Note 3)		10/100 Mbps Auto-sensing (has built-in isolated power circuit) ^(Note 3)			10/100 Mbps Auto-sensing (has built-in isolated power circuit) ^(Note 3)
SD card (support SDHC)					N/A	SD card (support SDHC)	N/A	SD card (support SDHC)	
1 USB Host ^(Note 2) Ver 1.1 / 1 USB Client Ver 2.0									
RS-232 (supports hardware flow control)									
RS-232 / RS-422 / RS-485		RS-232 / RS-422 RS-485 (has built-in isolated power circuit) ^(Note 3)	RS-232 / RS-422 / RS-485		RS-232 / RS-485 (has built-in isolated power circuit) ^(Note 3)			RS-232 / RS-422 / RS-485 (has built-in isolated power circuit) ^(Note 3)	
RS-232 / RS-422 / RS-485		RS-232 / RS-422 RS-485 (has built-in isolated power circuit) ^(Note 3)	RS-232 / RS-422 RS-485	RS-232 / RS-422 / RS-485 (has built-in isolated power circuit) ^(Note 3)					
N/A									
Built-in									
Natural air circulation									
CE / UL ^(Note 4) / KCC ^(Note 4)									
IP65 / NEMA4									
DC +24V (-10% ~ +15%) (please use isolated power supply)	DC +24V (-10% ~ +15%) (has built-in isolated power circuit) ^(Note 3)	DC +24V (-10% ~ +15%) (please use isolated power supply)	DC +24V (-10% ~ +15%) (has built-in isolated power circuit) ^(Note 3)	DC +24V (-10% ~ +15%) (has built-in isolated power circuit) ^(Note 3)					
AC500V for 1 minute (between charging DC24 terminal and FG terminals)									
7.68W	7.68W	7.68W	5.2W	7.8W	6.1W	9.6W	6.6W	12W	12W
3V lithium battery CR2032 x 1									
It depends on the temperature used and the conditions of usage, about 3 years or more at 25°C									
0°C ~ 50°C									
-20°C ~ +60°C									
10% ~ 90% RH [0 ~ 40°C], 10% ~ 55% RH [41 ~ 50°C], Pollution Degree 2									
IEC 61131-2 compliant 5Hz ~ 8.3Hz = Continuous: 3.5mm, 8.3Hz ~ 150Hz = Continuous: 1.0g IEC 60068-2-27 compliant 15g peak for 11 ms duration, X, Y, Z directions for 6 times									
184 x 144 x 50	184 x 144 x 50	184 x 144 x 50	227.1 x 174.1 x 61	227.1 x 174.1 x 61	299 x 224 x 51.1	299 x 224 x 51.1	272 x 200 x 61	272 x 200 x 61	272 x 200 x 61
172.4 x 132.4	172.4 x 132.4	172.4 x 132.4	219.4 x 166.5	219.4 x 166.5	285.2 x 210.2	285.2 x 210.2	261.3 x 189.3	261.3 x 189.3	261.3 x 189.3
Approx. 800g	Approx. 800g	Approx. 800g	Approx. 1226g	Approx. 1228g	Approx. 1700g	Approx. 1700g	Approx. 1520g	Approx. 1520g	Approx. 1520g

1) The half-life of backlight is defined as original luminance being reduced by 50% when the maximum driving current is supplied to HMI.

2) USB Host port can provide up to 5V/500mA of power.

3) The isolated power circuit can withstand a 1500V voltage peak for 1 minute.

4) Some models are in the process of application for UL and KCC certification. For more information, please consult our distributors.

5) The value of the power consumption indicates the electrical power consumed by HMI with no peripheral devices connected. To ensure normal operation, it is recommended using a power supply with a capacity 1.5 ~ 2 times the value of the power consumption.

6) Users can download the DOPSoft, the program editor of Delta HMI products and the user manual via the following link:

<http://www.delta.com.tw/ia>

7) The content of this catalogue may be revised without prior notice. Please consult our distributors or download the most updated version at

<http://www.delta.com.tw/ia>



Smarter. Greener. Together.

Industrial Automation Headquarters

Delta Electronics, Inc.

Taoyuan Technology Center
No.18, Xinglong Rd., Taoyuan City,
Taoyuan County 33068, Taiwan
TEL: 886-3-362-6301 / FAX: 886-3-371-6301

Asia

Delta Electronics (Jiangsu) Ltd.

Wujiang Plant 3
1688 Jiangxing East Road,
Wujiang Economic Development Zone
Wujiang City, Jiang Su Province,
People's Republic of China (Post code: 215200)
TEL: 86-512-6340-3008 / FAX: 86-769-6340-7290

Delta Greentech (China) Co., Ltd.

238 Min-Xia Road, Pudong District,
Shanghai, P.R.C.
Post code : 201209
TEL: 86-21-58635678 / FAX: 86-21-58630003

Delta Electronics (Japan), Inc.

Tokyo Office
2-1-14 Minato-ku Shibadaimon,
Tokyo 105-0012, Japan
TEL: 81-3-5733-1111 / FAX: 81-3-5733-1211

Delta Electronics (Korea), Inc.

1511, Byucksan Digital Valley 6-cha, Gasan-dong,
Geumcheon-gu, Seoul, Korea, 153-704
TEL: 82-2-515-5303 / FAX: 82-2-515-5302

Delta Electronics Int'l (S) Pte Ltd

4 Kaki Bukit Ave 1, #05-05, Singapore 417939
TEL: 65-6747-5155 / FAX: 65-6744-9228

Delta Electronics (India) Pvt. Ltd.

Plot No 43 Sector 35, HSIDC
Gurgaon, PIN 122001, Haryana, India
TEL : 91-124-4874900 / FAX : 91-124-4874945

Americas

Delta Products Corporation (USA)

Raleigh Office
P.O. Box 12173, 5101 Davis Drive,
Research Triangle Park, NC 27709, U.S.A.
TEL: 1-919-767-3800 / FAX: 1-919-767-8080

Delta Greentech (Brasil) S.A

Sao Paulo Office
Rua Itapeva, 26 - 3º andar Edificio Itapeva One-Bela Vista
01332-000-São Paulo-SP-Brazil
TEL: +55 11 3568-3855 / FAX: +55 11 3568-3865

Europe

Deltronics (The Netherlands) B.V.

Eindhoven Office
De Witbogt 15, 5652 AG Eindhoven, The Netherlands
TEL: 31-40-2592850 / FAX: 31-40-2592851

*We reserve the right to change the information in this catalogue without prior notice.