



Is Now Part of



**ON Semiconductor®**

To learn more about ON Semiconductor, please visit our website at  
[www.onsemi.com](http://www.onsemi.com)

ON Semiconductor and the ON Semiconductor logo are trademarks of Semiconductor Components Industries, LLC dba ON Semiconductor or its subsidiaries in the United States and/or other countries. ON Semiconductor owns the rights to a number of patents, trademarks, copyrights, trade secrets, and other intellectual property. A listing of ON Semiconductor's product/patent coverage may be accessed at [www.onsemi.com/site/pdf/Patent-Marking.pdf](http://www.onsemi.com/site/pdf/Patent-Marking.pdf). ON Semiconductor reserves the right to make changes without further notice to any products herein. ON Semiconductor makes no warranty, representation or guarantee regarding the suitability of its products for any particular purpose, nor does ON Semiconductor assume any liability arising out of the application or use of any product or circuit, and specifically disclaims any and all liability, including without limitation special, consequential or incidental damages. Buyer is responsible for its products and applications using ON Semiconductor products, including compliance with all laws, regulations and safety requirements or standards, regardless of any support or applications information provided by ON Semiconductor. "Typical" parameters which may be provided in ON Semiconductor data sheets and/or specifications can and do vary in different applications and actual performance may vary over time. All operating parameters, including "Typicals" must be validated for each customer application by customer's technical experts. ON Semiconductor does not convey any license under its patent rights nor the rights of others. ON Semiconductor products are not designed, intended, or authorized for use as a critical component in life support systems or any FDA Class 3 medical devices or medical devices with a same or similar classification in a foreign jurisdiction or any devices intended for implantation in the human body. Should Buyer purchase or use ON Semiconductor products for any such unintended or unauthorized application, Buyer shall indemnify and hold ON Semiconductor and its officers, employees, subsidiaries, affiliates, and distributors harmless against all claims, costs, damages, and expenses, and reasonable attorney fees arising out of, directly or indirectly, any claim of personal injury or death associated with such unintended or unauthorized use, even if such claim alleges that ON Semiconductor was negligent regarding the design or manufacture of the part. ON Semiconductor is an Equal Opportunity/Affirmative Action Employer. This literature is subject to all applicable copyright laws and is not for resale in any manner.

**N-Channel Logic Level Power MOSFET  
50V, 16A, 47 mΩ**

These are N-Channel logic level power MOSFETs manufactured using the MegaFET process. This process, which uses feature sizes approaching those of LSI integrated circuits gives optimum utilization of silicon, resulting in outstanding performance. They were designed for use with logic level (5V) driving sources in applications such as programmable controllers, switching regulators, switching converters, motor relay drivers and emitter switches for bipolar transistors. This performance is accomplished through a special gate oxide design which provides full rated conductance at gate biases in the 3V to 5V range, thereby facilitating true on-off power control directly from logic circuit supply voltages.

Formerly developmental type TA09871.

**Ordering Information**

PART NUMBER	PACKAGE	BRAND
RFD16N05LSM9A	TO-252AA	RFD16N05LSM

**Features**

- 16A, 50V
- $r_{DS(ON)} = 0.047\Omega$
- UIS SOA Rating Curve (Single Pulse)
- Design Optimized for 5V Gate Drives
- Can be Driven Directly from CMOS, NMOS, TTL Circuits
- SOA is Power Dissipation Limited
- Nanosecond Switching Speeds
- Linear Transfer Characteristics
- High Input Impedance
- Majority Carrier Device
- Related Literature
  - TB334 "Guidelines for Soldering Surface Mount Components to PC Boards"

**Symbol**

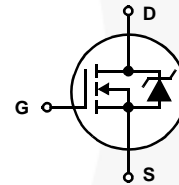

**Packaging**

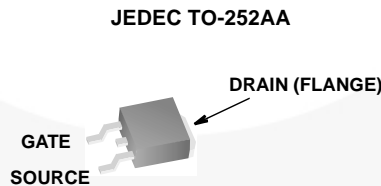

# RFD16N05LSM

## Absolute Maximum Ratings $T_C = 25^\circ\text{C}$ , Unless Otherwise Specified

	RFD16N05LSM9A	UNITS
Drain to Source Voltage (Note 1) . . . . .	50	V
Drain to Gate Voltage ( $R_{GS} = 20k\Omega$ ) (Note 1) . . . . .	50	V
Continuous Drain Current . . . . .	16	A
Pulsed Drain Current (Note 3) . . . . .	45	A
Gate to Source Voltage . . . . .	$\pm 10$	V
Maximum Power Dissipation . . . . .	60	W
Derate Above $25^\circ\text{C}$ . . . . .	0.48	$\text{W}/^\circ\text{C}$
Operating and Storage Temperature . . . . .	-55 to 150	$^\circ\text{C}$
Maximum Temperature for Soldering		
Leads at 0.063in (1.6mm) from Case for 10s . . . . .	300	$^\circ\text{C}$
Package Body for 10s, See Techbrief 334 . . . . .	260	$^\circ\text{C}$

CAUTION: Stresses above those listed in "Absolute Maximum Ratings" may cause permanent damage to the device. This is a stress only rating and operation of the device at these or any other conditions above those indicated in the operational sections of this specification is not implied.

NOTE:

1.  $T_J = 25^\circ\text{C}$  to  $125^\circ\text{C}$ .

## Electrical Specifications $T_C = 25^\circ\text{C}$ , Unless Otherwise Specified

PARAMETER	SYMBOL	TEST CONDITIONS	MIN	TYP	MAX	UNITS	
Drain to Source Breakdown Voltage	$BV_{DSS}$	$I_D = 250\text{mA}$ , $V_{GS} = 0\text{V}$ , Figure 10	50	-	-	V	
Gate to Threshold Voltage	$V_{GS(TH)}$	$V_{GS} = V_{DS}$ , $I_D = 250\text{mA}$ , Figure 9	1	-	2	V	
Zero Gate Voltage Drain Current	$I_{DSS}$	$V_{DS} = 40\text{V}$ , $V_{GS} = 0\text{V}$	-	-	1	$\mu\text{A}$	
		$T_C = 150^\circ\text{C}$	-	-	50	$\mu\text{A}$	
Gate to Source Leakage Current	$I_{GSS}$	$V_{GS} = \pm 10\text{V}$ , $V_{DS} = 0\text{V}$	-	-	100	nA	
Drain to Source On Resistance (Note 2)	$r_{DS(ON)}$	$I_D = 16\text{A}$ , $V_{GS} = 5\text{V}$	-	-	0.047	$\Omega$	
		$I_D = 16\text{A}$ , $V_{GS} = 4\text{V}$	-	-	0.056	$\Omega$	
Turn-On Time	$t_{(ON)}$	$V_{DD} = 25\text{V}$ , $I_D = 8\text{A}$ , $V_{GS} = 5\text{V}$ , $R_{GS} = 12.5\Omega$ Figures 15, 16	-	-	60	ns	
Turn-On Delay Time	$t_{d(ON)}$		-	14	-	ns	
Rise Time	$t_r$		-	30	-	ns	
Turn-Off Delay Time	$t_{d(OFF)}$		-	42	-	ns	
Fall Time	$t_f$		-	14	-	ns	
Turn-Off Time	$t_{(OFF)}$		-	-	-	100	ns
Total Gate Charge	$Q_g(TOT)$	$V_{GS} = 0\text{V}$ to $10\text{V}$	$V_{DD} = 40\text{V}$ , $I_D = 16\text{A}$ , $R_L = 2.5\Omega$ Figures 17, 18	-	-	80	nC
Gate Charge at 5V	$Q_g(5)$	$V_{GS} = 0\text{V}$ to $5\text{V}$		-	-	45	nC
Threshold Gate Charge	$Q_g(TH)$	$V_{GS} = 0\text{V}$ to $1\text{V}$		-	-	3	nC
Thermal Resistance Junction to Case	$R_{\theta JC}$		-	-	2.083	$^\circ\text{C}/\text{W}$	
Thermal Resistance Junction to Ambient	$R_{\theta JA}$		-	-	100	$^\circ\text{C}/\text{W}$	

## Source to Drain Diode Specifications

PARAMETER	SYMBOL	TEST CONDITIONS	MIN	TYP	MAX	UNITS
Source to Drain Diode Voltage	$V_{SD}$	$I_{SD} = 16\text{A}$	-	-	1.5	V
Diode Reverse Recovery Time	$t_{rr}$	$I_{SD} = 16\text{A}$ , $dI_{SD}/dt = 100\text{A}/\mu\text{s}$	-	-	125	ns

NOTES:

2. Pulse Test: Pulse Width  $\leq 300\text{ms}$ , Duty Cycle  $\leq 2\%$ .
3. Repetitive Rating: Pulse Width limited by max junction temperature.

Typical Performance Curves Unless Otherwise Specified

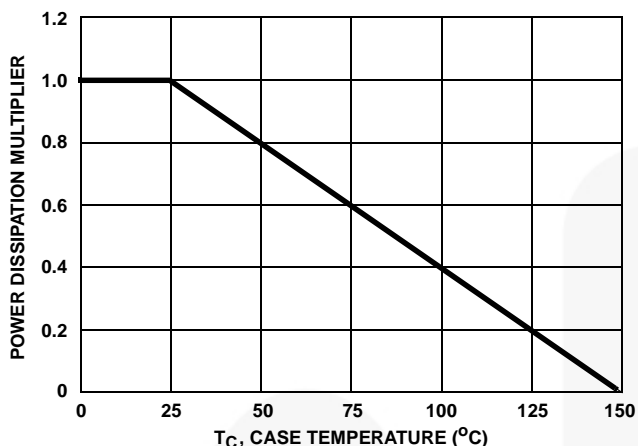

FIGURE 1. NORMALIZED POWER DISSIPATION vs CASE TEMPERATURE

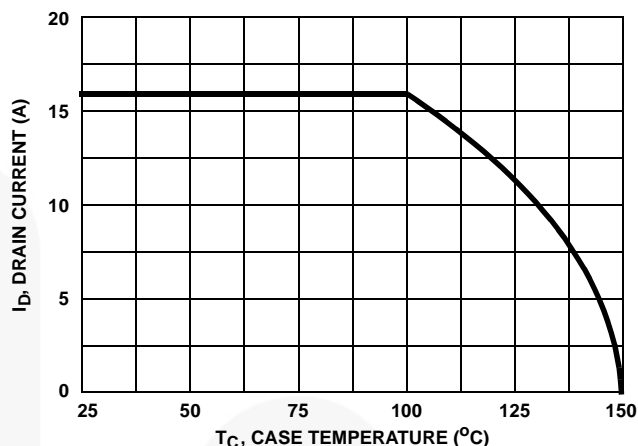

FIGURE 2. MAXIMUM CONTINUOUS DRAIN CURRENT vs CASE TEMPERATURE

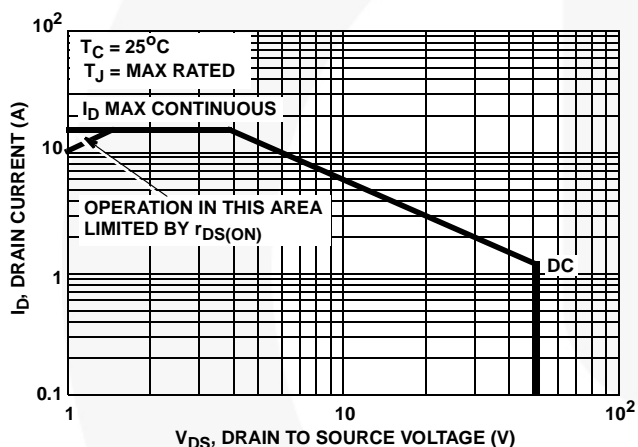

FIGURE 3. FORWARD BIAS SAFE OPERATING AREA

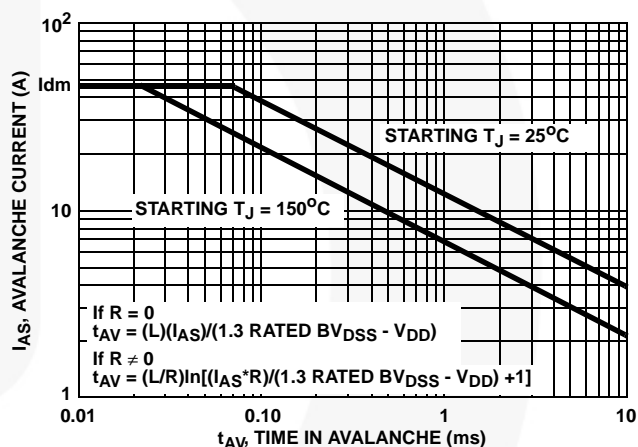

FIGURE 4. UNCLAMPED INDUCTIVE SWITCHING SOA (SINGLE PULSE UIS SOA)

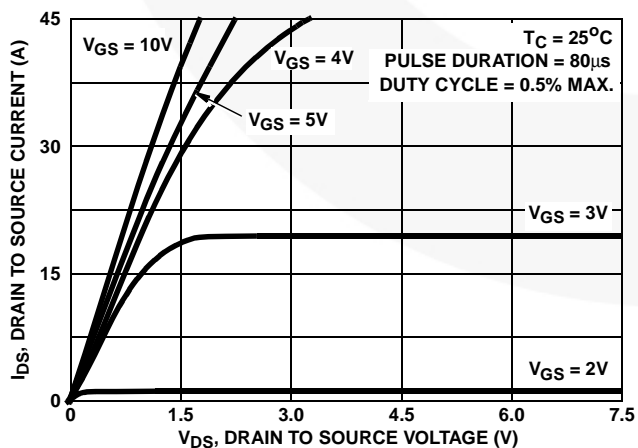

FIGURE 5. SATURATION CHARACTERISTICS

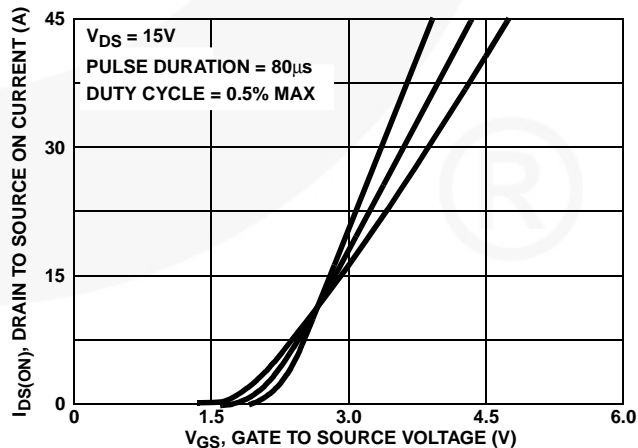

FIGURE 6. TRANSFER CHARACTERISTICS

Typical Performance Curves Unless Otherwise Specified (Continued)

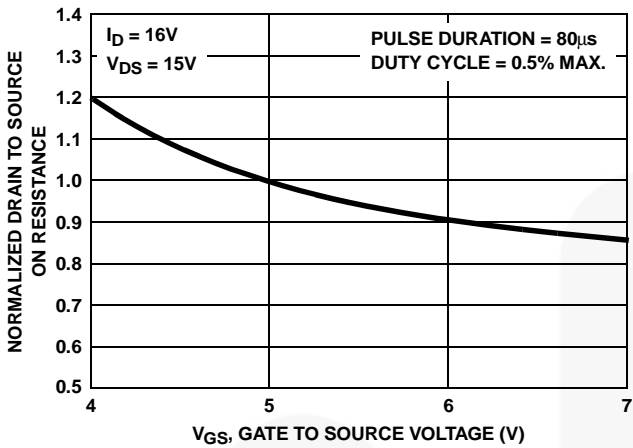

FIGURE 7. DRAIN TO SOURCE ON RESISTANCE vs GATE VOLTAGE AND DRAIN CURRENT

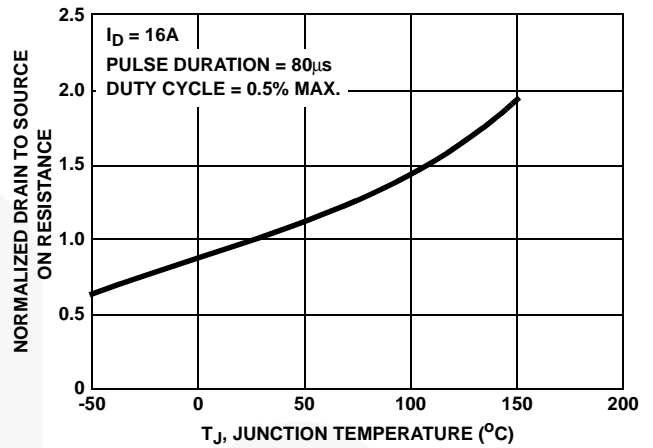

FIGURE 8. NORMALIZED DRAIN TO SOURCE ON RESISTANCE vs JUNCTION TEMPERATURE

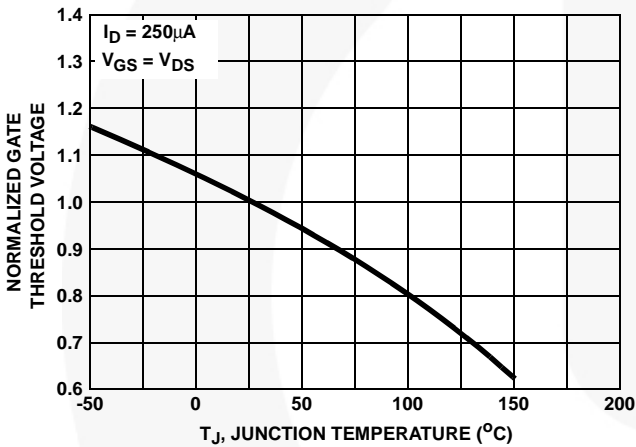

FIGURE 9. NORMALIZED GATE THRESHOLD vs JUNCTION TEMPERATURE

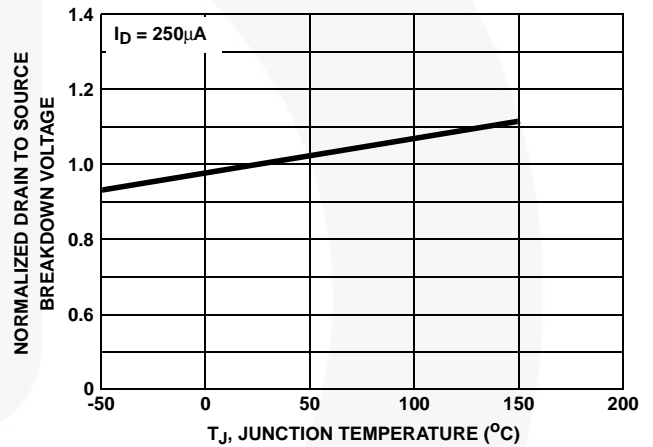

FIGURE 10. NORMALIZED DRAIN TO SOURCE BREAKDOWN VOLTAGE vs JUNCTION TEMPERATURE

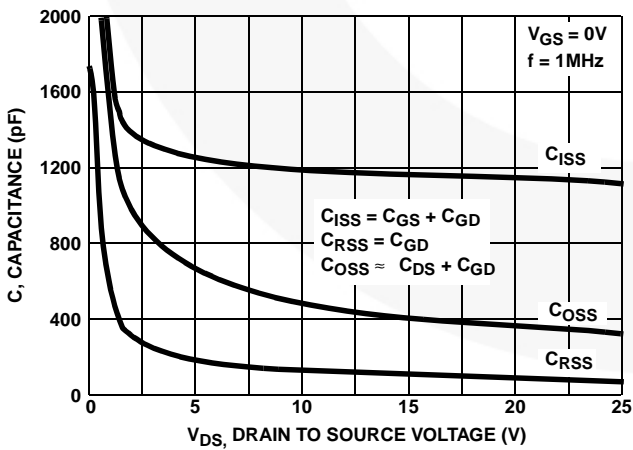

FIGURE 11. CAPACITANCE vs DRAIN TO SOURCE VOLTAGE

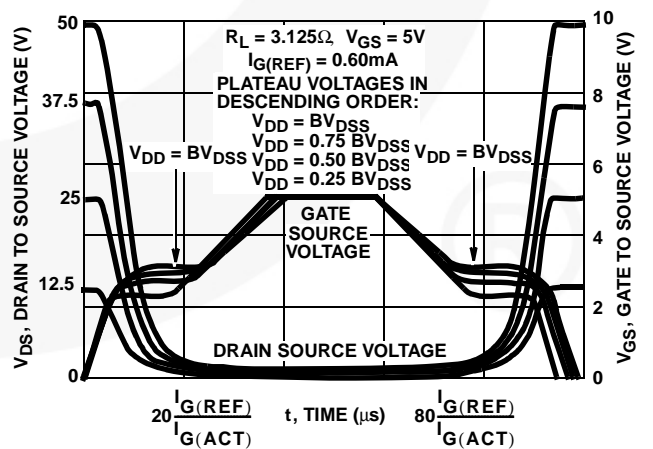

FIGURE 12. NORMALIZED SWITCHING WAVEFORMS FOR CONSTANT GATE CURRENT

Test Circuits and Waveforms

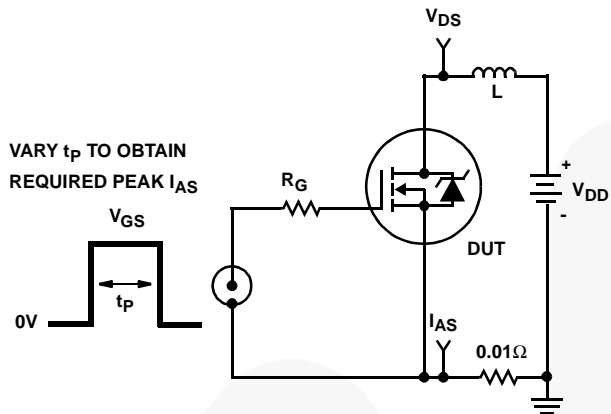

FIGURE 13. UNCLAMPED ENERGY TEST CIRCUIT

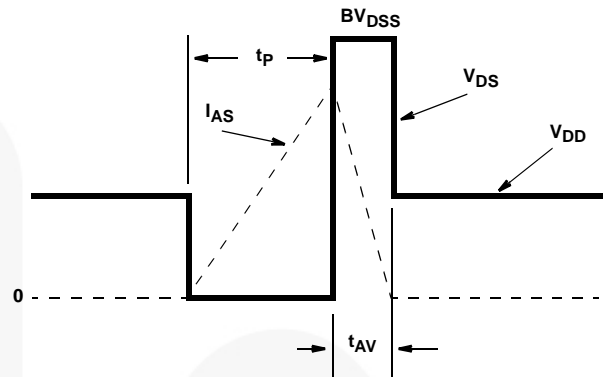

FIGURE 14. UNCLAMPED ENERGY WAVEFORMS

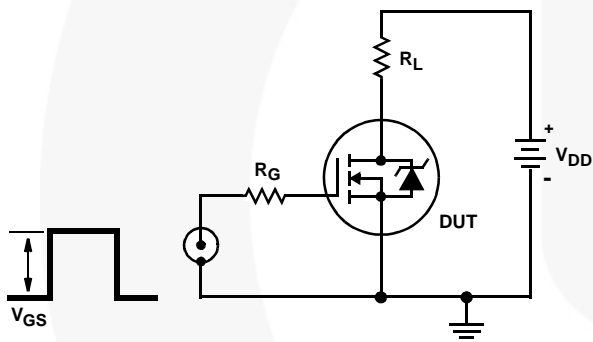

FIGURE 15. SWITCHING TIME TEST CIRCUIT

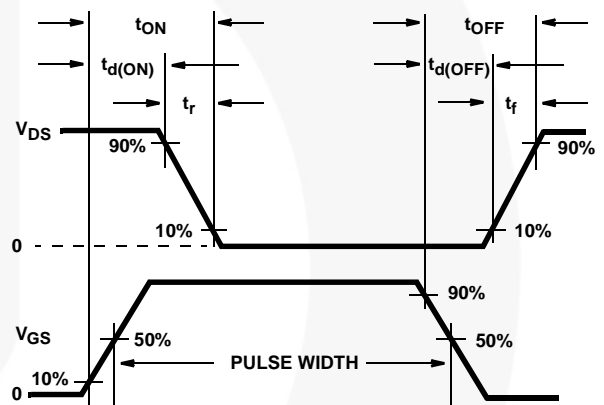

FIGURE 16. RESISTIVE SWITCHING WAVEFORMS

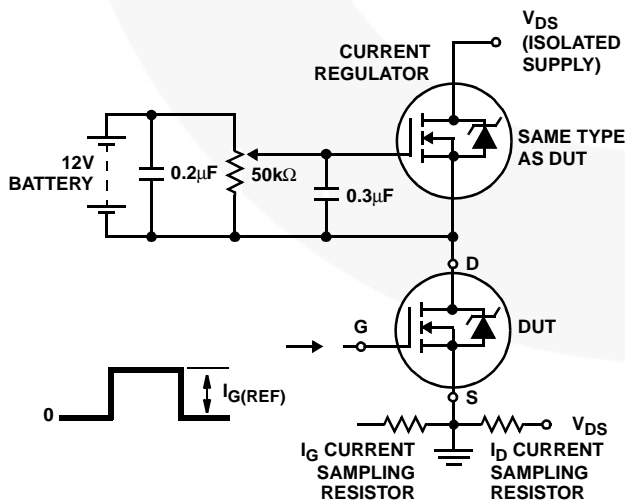

FIGURE 17. GATE CHARGE TEST CIRCUIT

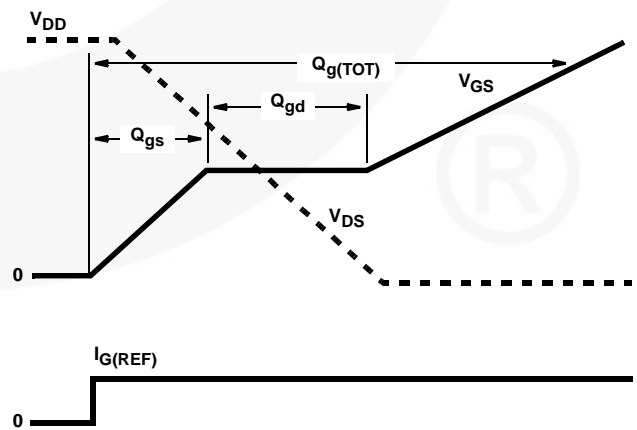



FIGURE 18. GATE CHARGE WAVEFORMS





## TRADEMARKS

The following includes registered and unregistered trademarks and service marks, owned by Fairchild Semiconductor and/or its global subsidiaries, and is not intended to be an exhaustive list of all such trademarks.

AccuPower™	F-PFS™	PowerTrench®	Sync-Lock™
AX-CAP®*	FRFET®	PowerXS™	SYSTEM GENERAL®*
BitSiC™	Global Power Resource™	Programmable Active Droop™	TinyBoost®
Build it Now™	GreenBridge™	QFET®	TinyBuck®
CorePLUS™	Green FPS™	QS™	TinyCalc™
CorePOWER™	Green FPS™ e-Series™	Quiet Series™	TinyLogic®
CROSSVOLT™	Gmax™	RapidConfigure™	TINYOPTO™
CTL™	GTO™	Saving our world, 1mW/W/kW at a time™	TinyPower™
Current Transfer Logic™	IntelliMAX™	SignalWise™	TinyPWM™
DEUXPEED®	ISOPLANAR™	SmartMax™	TinyWire™
Dual Cool™	Marking Small Speakers Sound Louder and Better™	SMART START™	TranSiC™
EcoSPARK®	MegaBuck™	Solutions for Your Success™	TriFault Detect™
EfficientMax™	MICROCOUPLER™	SPM®	TRUECURRENT®*
ESBC™	MicroFET™	STEALTH™	μSerDes™
 Fairchild®	MicroPak™	SuperFET®	UHC®
Fairchild Semiconductor®	MicroPak2™	SuperSOT™-3	Ultra FRFET™
FACT Quiet Series™	MillerDrive™	SuperSOT™-6	UniFET™
FACT®	MotionMax™	SuperSOT™-8	VCX™
FAST®	mWSaver®	SupreMOS®	VisualMax™
FastvCore™	OptoHiT™	SyncFET™	VoltagePlus™
FETBench™	OPTOLOGIC®		XS™
FPS™	OPTOPLANAR®		

\*Trademarks of System General Corporation, used under license by Fairchild Semiconductor.

## DISCLAIMER

FAIRCHILD SEMICONDUCTOR RESERVES THE RIGHT TO MAKE CHANGES WITHOUT FURTHER NOTICE TO ANY PRODUCTS HEREIN TO IMPROVE RELIABILITY, FUNCTION, OR DESIGN. FAIRCHILD DOES NOT ASSUME ANY LIABILITY ARISING OUT OF THE APPLICATION OR USE OF ANY PRODUCT OR CIRCUIT DESCRIBED HEREIN; NEITHER DOES IT CONVEY ANY LICENSE UNDER ITS PATENT RIGHTS, NOR THE RIGHTS OF OTHERS. THESE SPECIFICATIONS DO NOT EXPAND THE TERMS OF FAIRCHILD'S WORLDWIDE TERMS AND CONDITIONS, SPECIFICALLY THE WARRANTY THEREIN, WHICH COVERS THESE PRODUCTS.

## LIFE SUPPORT POLICY

FAIRCHILD'S PRODUCTS ARE NOT AUTHORIZED FOR USE AS CRITICAL COMPONENTS IN LIFE SUPPORT DEVICES OR SYSTEMS WITHOUT THE EXPRESS WRITTEN APPROVAL OF FAIRCHILD SEMICONDUCTOR CORPORATION.

As used here in:

- Life support devices or systems are devices or systems which, (a) are intended for surgical implant into the body or (b) support or sustain life, and (c) whose failure to perform when properly used in accordance with instructions for use provided in the labeling, can be reasonably expected to result in a significant injury of the user.
- A critical component in any component of a life support, device, or system whose failure to perform can be reasonably expected to cause the failure of the life support device or system, or to affect its safety or effectiveness.

## ANTI-COUNTERFEITING POLICY

Fairchild Semiconductor Corporation's Anti-Counterfeiting Policy. Fairchild's Anti-Counterfeiting Policy is also stated on our external website, [www.Fairchildsemi.com](http://www.Fairchildsemi.com), under Sales Support.

Counterfeiting of semiconductor parts is a growing problem in the industry. All manufacturers of semiconductor products are experiencing counterfeiting of their parts. Customers who inadvertently purchase counterfeit parts experience many problems such as loss of brand reputation, substandard performance, failed application, and increased cost of production and manufacturing delays. Fairchild is taking strong measures to protect ourselves and our customers from the proliferation of counterfeit parts. Fairchild strongly encourages customers to purchase Fairchild parts either directly from Fairchild or from Authorized Fairchild Distributors who are listed by country on our web page cited above. Products customers buy either from Fairchild directly or from Authorized Fairchild Distributors are genuine parts, have full traceability, meet Fairchild's quality standards for handling and storage and provide access to Fairchild's full range of up-to-date technical and product information. Fairchild and our Authorized Distributors will stand behind all warranties and will appropriately address and warranty issues that may arise. Fairchild will not provide any warranty coverage or other assistance for parts bought from Unauthorized Sources. Fairchild is committed to combat this global problem and encourage our customers to do their part in stopping this practice by buying direct or from authorized distributors.

## PRODUCT STATUS DEFINITIONS

### Definition of Terms

Datasheet Identification	Product Status	Definition
Advance Information	Formative / In Design	Datasheet contains the design specifications for product development. Specifications may change in any manner without notice.
Preliminary	First Production	Datasheet contains preliminary data; supplementary data will be published at a later date. Fairchild Semiconductor reserves the right to make changes at any time without notice to improve design.
No Identification Needed	Full Production	Datasheet contains final specifications. Fairchild Semiconductor reserves the right to make changes at any time without notice to improve the design.
Obsolete	Not In Production	Datasheet contains specifications on a product that is discontinued by Fairchild Semiconductor. The datasheet is for reference information only.

Rev. 166



ON Semiconductor and  are trademarks of Semiconductor Components Industries, LLC dba ON Semiconductor or its subsidiaries in the United States and/or other countries. ON Semiconductor owns the rights to a number of patents, trademarks, copyrights, trade secrets, and other intellectual property. A listing of ON Semiconductor's product/patent coverage may be accessed at [www.onsemi.com/site/pdf/Patent-Marking.pdf](http://www.onsemi.com/site/pdf/Patent-Marking.pdf). ON Semiconductor reserves the right to make changes without further notice to any products herein. ON Semiconductor makes no warranty, representation or guarantee regarding the suitability of its products for any particular purpose, nor does ON Semiconductor assume any liability arising out of the application or use of any product or circuit, and specifically disclaims any and all liability, including without limitation special, consequential or incidental damages. Buyer is responsible for its products and applications using ON Semiconductor products, including compliance with all laws, regulations and safety requirements or standards, regardless of any support or applications information provided by ON Semiconductor. "Typical" parameters which may be provided in ON Semiconductor data sheets and/or specifications can and do vary in different applications and actual performance may vary over time. All operating parameters, including "Typicals" must be validated for each customer application by customer's technical experts. ON Semiconductor does not convey any license under its patent rights nor the rights of others. ON Semiconductor products are not designed, intended, or authorized for use as a critical component in life support systems or any FDA Class 3 medical devices or medical devices with a same or similar classification in a foreign jurisdiction or any devices intended for implantation in the human body. Should Buyer purchase or use ON Semiconductor products for any such unintended or unauthorized application, Buyer shall indemnify and hold ON Semiconductor and its officers, employees, subsidiaries, affiliates, and distributors harmless against all claims, costs, damages, and expenses, and reasonable attorney fees arising out of, directly or indirectly, any claim of personal injury or death associated with such unintended or unauthorized use, even if such claim alleges that ON Semiconductor was negligent regarding the design or manufacture of the part. ON Semiconductor is an Equal Opportunity/Affirmative Action Employer. This literature is subject to all applicable copyright laws and is not for resale in any manner.

## PUBLICATION ORDERING INFORMATION

### LITERATURE FULFILLMENT:

Literature Distribution Center for ON Semiconductor  
19521 E. 32nd Pkwy, Aurora, Colorado 80011 USA  
**Phone:** 303-675-2175 or 800-344-3860 Toll Free USA/Canada  
**Fax:** 303-675-2176 or 800-344-3867 Toll Free USA/Canada  
**Email:** [orderlit@onsemi.com](mailto:orderlit@onsemi.com)

**N. American Technical Support:** 800-282-9855 Toll Free  
USA/Canada  
**Europe, Middle East and Africa Technical Support:**  
Phone: 421 33 790 2910  
**Japan Customer Focus Center**  
Phone: 81-3-5817-1050

**ON Semiconductor Website:** [www.onsemi.com](http://www.onsemi.com)  
**Order Literature:** <http://www.onsemi.com/orderlit>  
For additional information, please contact your local  
Sales Representative

# Mouser Electronics

Authorized Distributor

Click to View Pricing, Inventory, Delivery & Lifecycle Information:

[Fairchild Semiconductor:](#)

[RFD16N05LSM9A](#) [RFD16N05LSM](#)