

- Generates Noise, Tone, or Low-Frequency-Based Sounds, or Combinations of These
- Sounds Are Defined by User via External Components
- Allows Custom Sounds to be Created Easily
- Low Power Requirements
- Allows Multiple-Sound Systems
- Compatible with Microprocessor Systems

N OR NF DUAL-IN-LINE PACKAGE  
(TOP VIEW)

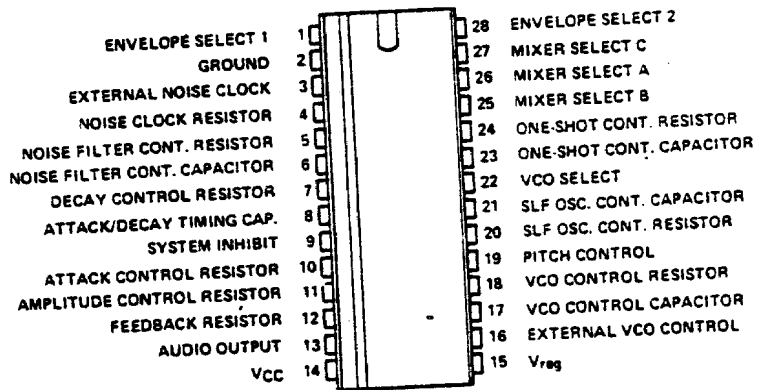

description

The SN76477 complex sound generator is a monolithic chip combining both analog (bipolar) and digital (12L) circuitry. It includes a noise generator, a voltage-controlled oscillator (VCO), and a super-low-frequency oscillator (SLF) together with a noise filter, mixer, attack/decay circuitry, audio amplifier, and control circuitry to provide noise, tone, or low-frequency sounds and any combinations of these. Programming is accomplished via control inputs and user-defined external components, which allows a wide variety of sounds to be created and tailored for particular applications. This device may be used in a variety of applications requiring audio feedback to the operator including entertainment equipment such as arcade or home video games, pinball games, toys; consumer-oriented equipment such as timers, alarms, and controls; and industrial equipment for indicators, alarms, controls, etc.

Operation is either from a five-volt regulated supply applied to  $V_{reg}$ , or from a 7.5-volt to 10-volt supply applied to a built-in voltage regulator through the  $V_{CC}$  terminal, in which case a regulated five volts is available from the  $V_{reg}$  terminal to power a small amount of external circuitry, or to provide a high-logic-level voltage to logic inputs.

More detailed information on the functions of various parts of this device is found elsewhere in this data sheet in the section entitled "Operation."

absolute maximum ratings at  $T_A = 25^\circ C$  (unless otherwise noted)

Supply voltage, $V_{CC}$ (see Note 1)	15 V
Supply voltage, $V_{reg}$	6
Input voltage: any logic input	12 V
any capacitor input	5 V
Operating free-air temperature range	$0^\circ C$ to $70^\circ C$
Storage temperature range	$-65^\circ C$ to $150^\circ C$
Lead temperature 1/16 inch (1.6 mm) from case for 10 seconds	$260^\circ C$

recommended operating conditions

	MIN	NOM	MAX	UNIT
Supply voltage, $V_{CC}$	7.5		10	V
Supply voltage, $V_{reg}$	4.5	5	5.5	V
Operating free-air temperature	-10	25	40	$^\circ C$

NOTE 1: All voltage values are with respect to the network ground terminal.

# TYPE SN76477 COMPLEX SOUND GENERATOR

electrical characteristics at  $V_{reg} = 5\text{ V}$ ,  $T_A = 25^\circ\text{C}$  (unless otherwise noted)

PARAMETER	AT PINS	TEST CONDITIONS	MIN	TYP	MAX	UNIT
$V_{IH}$ High-level input voltage	1, 9, 22, 25, 26, 27, 28		2		10	V
$V_{IL}$ Low-level input voltage	1, 9, 22, 25, 26, 27, 29				0.8	V
$V_{OPP}$ Maximum peak-to-peak output voltage swing	13	$R_{load} = 1\text{ k}\Omega$ , $I_{(pin\ 11)} = 200\ \mu\text{A}$	2.5	3.0		V
$V_{reg}$ Regulated output voltage	15	$V_{CC} = 8.25\text{ V}$ , $I_{load} = 10\text{ mA}$	4.5		5.5	V
Input regulation	15	$V_{CC} = 7.5\text{ V to }12\text{ V}$ , $I_{load} = 10\text{ mA}$		150		mV
Trip points	One-shot capacitor	23		2.5		V
	Noise filter capacitor	6		3.2		
	SLF capacitor	21		2.5		
External VCO cutoff voltage	16		2.35			V
$I_{IH}$ High-level input current	System inhibit or VCO select	9, 22	$V_{IH} = 2\text{ V}$		150	$\mu\text{A}$
	Other logic inputs	1, 25, 26, 27, 28	40	75		
Control input current	4, 5, 7, 10, 11, 18, 20, 24		1		400	$\mu\text{A}$
Dynamic output impedance	13			100		$\Omega$
$I_{CC}$ Supply current at $V_{CC}$	14	$V_{CC} = 8.5\text{ V}$ , All inputs and outputs open		5	10	mA

functional block diagram

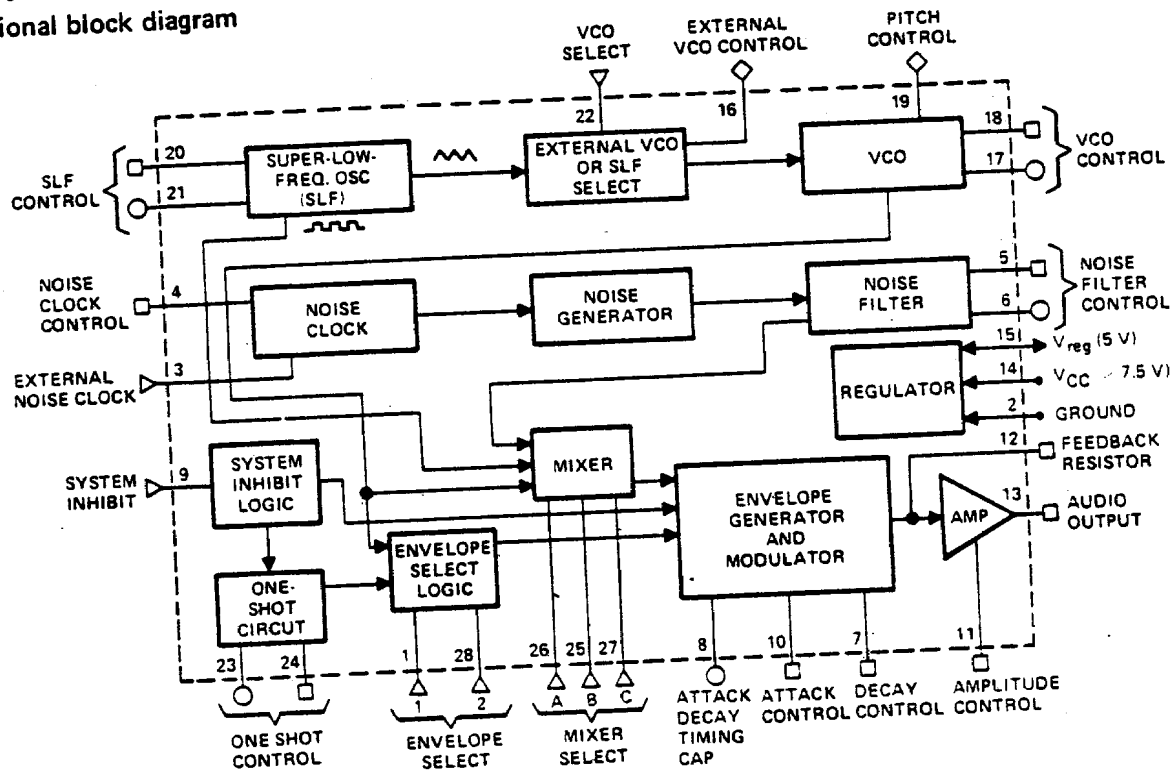

FIGURE 1

TEXAS INSTRUMENTS  
INCORPORATED

POST OFFICE BOX 225012 • DALLAS, TEXAS 75265

# TYPE SN76477 COMPLEX SOUND GENERATOR

## TABLE 1 SUMMARY OF FUNCTIONS

DESCRIPTION	INPUT LIMITS	PIN NO.	FUNCTION†	PARA. NO.‡
SLF Control Resistor ( $R_{SLF}$ )	7.5 k $\Omega$ Min	20	SLF frequency (Hz) $\approx \frac{0.64}{R_{SLF} \cdot C_{SLF}}$	1
SLF Control Capacitor ( $C_{SLF}$ )	See Note 2	21		
VCO Select	10 V Max	22	H = internal control (SLF) = external control (pin 16)	2
VCO Control Resistor ( $R_{VCO}$ )	7.5 k $\Omega$ Min	18	Min. VCO frequency (Hz) $\approx \frac{0.64}{R_{VCO} \cdot C_{VCO}}$	
VCO Control Capacitor ( $C_{VCO}$ )	See Note 2	17	Max. VCO freq. $\approx 10 \times$ Min. VCO freq.	
External VCO Control	0 V to 2.5 V	16	Increase in voltage decreases VCO frequency	
Pitch Control	5 V Max	19	VCO duty cycle $\approx 50 \times \frac{\text{voltage at pin 19}}{\text{voltage at pin 16}} \%$	
Noise Clock Control	47 k $\Omega$ Nom, 100 k $\Omega$ Max	4	47 k $\Omega$ enables internal noise clock, high logic level enables external noise clock input (pin 3)	3
External Noise Clock	10 V Max	3	Enabled by a high logic level at pin 4	
Noise Filter Control Resistor ( $R_{NF}$ )	7.5 k $\Omega$ Min	5	3 dB frequency (Hz) $\approx \frac{1.28}{R_{NF} \cdot C_{NF}}$	4
Noise Filter Control Capacitor ( $C_{NF}$ )	See Note 2	6		
Mixer Select A	10 V Max	26	Select one or a combination of generator outputs. See Table 2, Section 5.	5
Mixer Select B	10 V Max	25		
Mixer Select C	10 V Max	27		
System Inhibit	10 V Max	9	H inhibits sound output, L enables sound output, H-to-L transition triggers one-shot when operable	6
One-Shot Control Resistor ( $R_{OS}$ )	7.5 k $\Omega$ Min	24	One-shot duration (seconds) $\approx 0.8 \cdot R_{OS} \cdot C_{OS}$	7
One-Shot Control Capacitor ( $C_{OS}$ )	See Note 2	23		
Envelope Select 1	10 V Max	1	Select envelope for sound output from mixer. See Table 3, Section 8.	8
Envelope Select 2	10 V Max	28		
Attack/Decay Timing Capacitor ( $C_{A/D}$ )	See Note 2	8	Attack time (seconds) $\approx R_A \cdot C_{A/D}$	9
Attack Control Resistor ( $R_A$ )	7.5 k $\Omega$ Min	10	Decay time (seconds) $\approx R_D \cdot C_{A/D}$	
Decay Control Resistor ( $R_D$ )	7.5 k $\Omega$ Min	7		
Amplitude Control Resistor ( $R_G$ )	47 k $\Omega$ Min, 220 k $\Omega$ Max	11	$V_{out} \approx \frac{3.4R_F}{R_G}$ , when $R_F$ is connected between pin 12 and pin 13. See Note 3.	10
Feedback Resistor ( $R_F$ )		12		
Audio Output		13	Requires pull-down resistor from 2.7 k $\Omega$ to 10 k $\Omega$	11
Supply voltage, VCC	7.5 V Min, 10 V Max	14	Input if unregulated supply voltage is used (uses internal regulator). Leave open if 5-volt regulated power is applied to pin 15.	
Supply Voltage, Vreg	4.5 V Min, 5.5 V Max	15	Input for 5-volt regulated supply. If 7.5-volt to 10-volt supply is applied to pin 14, this becomes the output for up to 10 mA of 5-volt regulated supply for use outside the chip.	
Ground		2	Common ground	

† All equations are for  $V_{reg} = 5 \text{ V}$ ,  $T_A = 25^\circ \text{C}$ . Resistors and capacitors are connected from the pin indicated to ground unless otherwise noted.  
H = high logic level ( $\geq 2 \text{ V}$ ), L = low logic level ( $\leq 0.8 \text{ V}$  or open).

‡ Paragraph number referred to is in the section of this data sheet entitled "Operation."

- NOTES: 2. For effective operation, the voltage at any capacitor input pin should not exceed 4 volts.  
3. When this device is used with an external audio amplifier, pin 13 is connected to the input of the external amplifier, and feedback from the external amplifier is connected to pin 12.

**TEXAS INSTRUMENTS**  
INCORPORATED

POST OFFICE BOX 225012 • DALLAS, TEXAS 75265

# TYPE SN76477

## COMPLEX SOUND GENERATOR

### OPERATION

#### 1. super-low frequency oscillator (SLF)

The SLF is normally operated in the range of 0.1 hertz to 30 hertz, but will operate up to 20 kilohertz. The frequency is determined by two external components, the SLF control resistor ( $R_{SLF}$ ) at pin 20 and the SLF control capacitor ( $C_{SLF}$ ) at pin 21 according to the following equation:

$$\text{Equation 1: SLF frequency (Hz)} \approx \frac{0.64}{R_{SLF} \cdot C_{SLF}} \text{ at } V_{reg} = 5 \text{ V.}$$

$R_{SLF}$  should have a minimum value of 7.5 k $\Omega$ .

The SLF supplies two signals to other parts of the device. It feeds a 50% duty cycle square wave to the mixer, and it feeds a triangular wave to the external VCO or SLF select logic, where, if VCO select (pin 22) is at a high logic level, it is fed through to the VCO to modulate the frequency of that oscillator.

#### 2. voltage-controlled oscillator (VCO)

The VCO produces a tone output whose frequency is dependent upon the voltage at the input of the VCO. This controlling voltage may be either the SLF output described above, or an externally generated signal applied to the external VCO control, pin 16. The method of controlling the VCO is selected by the logic level at the VCO select (pin 22). With a low logic level applied to VCO select, the VCO frequency is controlled by an external signal applied to the external VCO control, pin 16. When a high is applied to the VCO select, the VCO frequency is controlled internally by the triangular waveform signal generated by the super-low-frequency oscillator, and the output of the VCO is a frequency modulated waveform as shown in Figure 2 below.

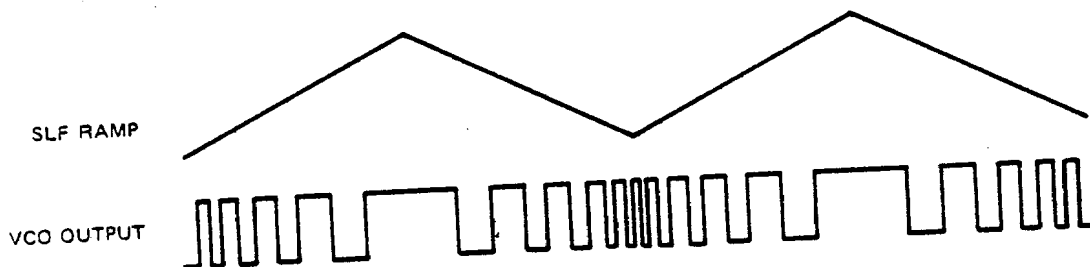

FIGURE 2

The higher the voltage applied to the VCO (either internally from the SLF or externally applied to pin 16), the lower the frequency of the VCO output. An alternate method of applying an external voltage to the VCO input is to do so indirectly by applying the controlling voltage to the SLF oscillator control capacitor input, pin 21. In some applications this may be more convenient than using the pin 16 input.

The minimum frequency of the VCO is determined by the VCO control resistor ( $R_{VCO}$ ) at pin 18 and the VCO control capacitor ( $C_{VCO}$ ) at pin 17 according to the following equation:

$$\text{Equation 2: Minimum VCO frequency (Hz)} \approx \frac{0.64}{R_{VCO} \cdot C_{VCO}} \text{ at } V_{reg} = 5 \text{ V.}$$

The frequency range of the VCO is internally determined at an approximate ratio of 10:1, so the maximum frequency of the VCO will be approximately ten times the minimum frequency determined by the external components  $R_{VCO}$  and  $C_{VCO}$ .

# TYPE SN76477

## COMPLEX SOUND GENERATOR

### OPERATION

#### 2. voltage-controlled oscillator (VCO) (continued)

When the external VCO control (pin 16) is used (VCO select, pin 22, is low), the voltage at the external VCO control should range from 0 to 2.35 volts. If this voltage goes above 2.35 volts, the output of the VCO section saturates at a high logic level and in turn saturates the output amplifier stage. This may be used as an alternative method of disabling the sound output without changing the system inhibit input. The input at the external VCO control may be a dc voltage producing a constant tone, or any digital or analog type input to modulate the frequency of the VCO.

The pitch control (pin 19) varies the duty cycle of the VCO output according to the following equation:

$$\text{Equation 3: VCO duty cycle} \approx 50 \times \frac{\text{voltage at pin 19}}{\text{voltage at pin 16}} \%$$

By leaving pin 19 high, a constant 50% duty cycle is achieved. The minimum duty cycle attainable is approximately 18%. The specific duty cycle applies to constant tones produced by applying a constant dc voltage at the external VCO control, but the pitch control may be used to aesthetically alter the pitch of any frequency-modulated VCO output signals.

The output of the VCO is a square-wave pulse and is supplied both to the mixer and through the envelope-select logic to the envelope generator and modulator.

#### 3. noise clock

The noise clock internally generates clock pulses and supplies them to the noise generator. The noise clock resistor (pin 4) sets the internal operating current for the noise clock section. The nominal value for this resistor is 47 k $\Omega$ . For faster clock rates, a smaller valued resistor may be used. For slower clock rates, a higher valued resistor may be used, but it should be limited to a maximum of 100 k $\Omega$ . It may be desirable to use an external noise clock to provide a lower frequency noise or a more precise clock rate. This external clock signal should be applied to the external noise clock terminal (pin 3), and the noise clock resistor input should be taken to a high logic voltage level. The external clock signal should be a 10-volt-maximum peak-to-peak square wave.

#### 4. noise generator/filter

The noise generator produces pseudo-random white noise that passes through the noise filter before being applied to the mixer. The variable-band-width low-pass filter has its 3-dB rolloff point defined by the noise filter control resistor (RNF) at pin 5 and the noise filter control capacitor (CNF) according to the following equation:

$$\text{Equation 4: 3-dB frequency (Hz)} \approx \frac{1.28}{\text{RNF} \cdot \text{CNF}} \text{ at } V_{\text{reg}} = 5 \text{ V.}$$

RNF should have a minimum value of 7.5 k $\Omega$  in order to limit the current in the noise filter section to a safe operating level.

# TYPE SN76477 COMPLEX SOUND GENERATOR

## OPERATION

### 5. mixer

The mixer logic selects one or a combination of the inputs from the generators and feeds the output to the envelope generator and modulator. The mixer performs a logical AND function on these sounds; therefore, the output of the mixer is not a combination of simultaneous sounds. The output of the mixer is determined by the logic levels at the mixer select inputs as shown in Table 2, below.

TABLE 2

MIXER SELECT INPUTS			MIXER OUTPUT
C (PIN 27)	B (PIN 25)	A (PIN 26)	
L	L	L	VCO
L	L	H	SLF
L	H	L	NOISE
L	H	H	VCO/NOISE
H	L	L	SLF/NOISE
H	L	H	SLF/VCO/NOISE
H	H	L	SLF/VCO
H	H	H	INHIBIT

H = high level  
L = low level or open

Figure 3 is an example of how two signals would be combined by the mixer according to the logical AND function with the mixer select times set for SLF/noise (C input high, A and B inputs low).

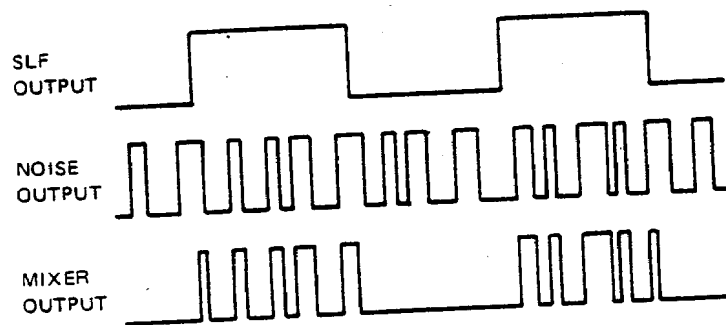

FIGURE 3

To obtain two sounds occurring simultaneously (e.g., car engine and siren or steam engine and whistle), an external multiplexer is required. The multiplexer is an oscillator or frequency generator that can switch the mixer select lines at a rapid rate so that the two sounds seem to occur at the same time. The frequency of the multiplexer should be above the human hearing range of 20 kHz, but not greater than 100 kHz. A multiplexer with a 50% duty cycle would provide equal amplitudes for both sound functions.

The output of the mixer is supplied to the envelope generator and modulator.

**OPERATION**

**6. system inhibit**

The system inhibit logic provides inhibit/select control for the sound output of the system: a high logic level at the system inhibit terminal (pin 9) inhibits the sound output, a low logic level (or open) enables it. This input also triggers the one-shot circuit for momentary sounds such as gunshots, bells, or explosions. The one-shot logic is triggered on the negative-going edge of the system inhibit input. This may be accomplished by means of a momentary switch or by a square-wave input to system inhibit. The system inhibit input must be held low for the entire duration of the one-shot sound including attack and decay periods if the sound is to be completed. Taking the system inhibit input high early terminates the sound. Note that the one-shot is operable only when the proper envelope select logic is selected (see Section 8).

**7. one-shot**

As mentioned in Section 6 above, the one-shot circuit controls momentary sounds, and is triggered by a high-to-low logic-level transition at the system inhibit input (pin 9). The duration of the one-shot is determined by the one-shot control resistor (ROS) at pin 24 and the one-shot control capacitor (COS) at pin 23 according to the following equation:

$$\text{Equation 5: One-shot duration (seconds)} \approx 0.8 \cdot \text{ROS} \cdot \text{COS at } V_{\text{reg}} = 5 \text{ V.}$$

Maximum duration of the one-shot is approximately 10 seconds. If the one-shot is terminated early by taking the system inhibit input high, the one-shot timing must be allowed to end so that an internal latch will be reset before another one-shot can be triggered. The one-shot may also be controlled by external logic eliminating the need for the one-shot control resistor and capacitor. This is done by triggering the one-shot in the normal way at the system inhibit input, and terminating it by taking pin 23 (one-shot control capacitor) high.

The output of the one-shot is fed through the envelope select logic to the envelope generator and modulator, therefore it is operable only when the one-shot envelope is selected by the envelope select inputs (see Section 8). The one-shot does not generate sound as such, but provides an envelope for the sound supplied to the envelope generator and modulator by the mixer.

**8. envelope select**

The envelope select logic determines the envelope that is applied to the mixer output according to the following table:

TABLE 3

ENVELOPE SELECT		FUNCTION SELECTED	WAVEFORM (SEE FIGURE 4)
1 (PIN 1)	2 (PIN 28)		
L	L	VCO	A
L	H	Mixer only	B
H	L	One-shot	C
H	H	VCO with alternating cycles	D

H = high level  
L = low level or open

# TYPE SN76477 COMPLEX SOUND GENERATOR

## OPERATION

### 8. envelope select (continued)

If the function selected is mixer only, no envelope is selected and the mixer output is supplied continuously to the audio amplifier. If VCO is selected, the square-wave output of the VCO is the envelope for the mixer output, and the mixer output is gated by the VCO output; that is, the mixer output is passed on to the audio amplifier while the VCO output is high and inhibited while the VCO output is low. If one-shot is selected, the output from the mixer is enabled only for the duration of the one-shot pulse. VCO with alternating polarity is similar to the VCO envelope described above except that every other VCO pulse is inverted with the result that only every other output pulse from the VCO enables the output from the mixer.

Figure 4 shows examples of the four selectable envelopes with noise as the mixer output.

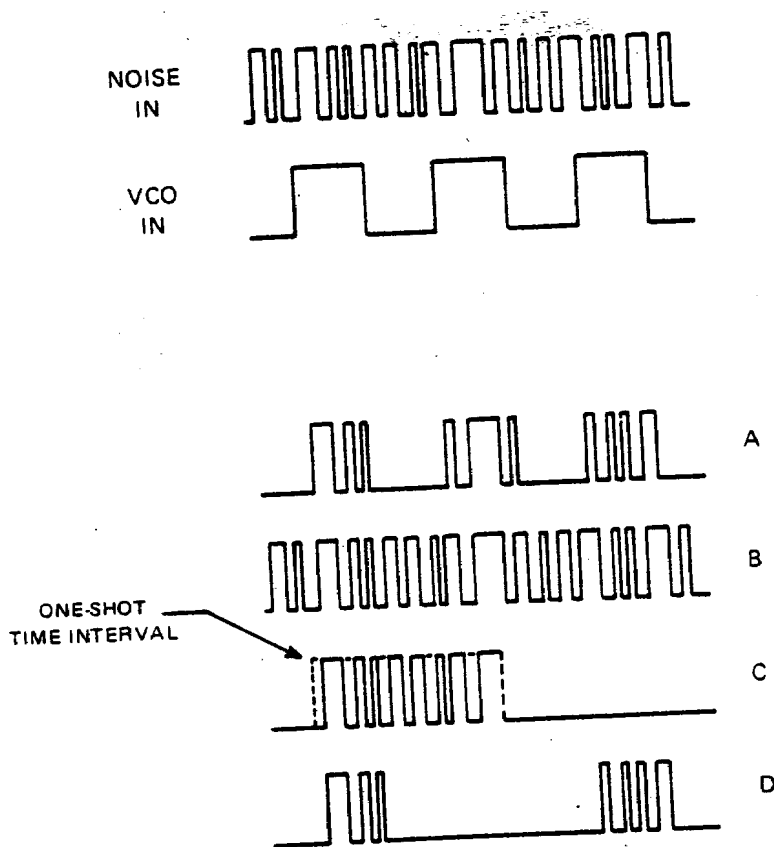

FIGURE 4: EXAMPLES OF THE FOUR SELECTABLE ENVELOPES USING NOISE AS MIXER OUTPUT: (A) VCO, (B) MIXER ONLY, (C) ONE-SHOT, (D) VCO WITH ALTERNATING CYCLES.



### OPERATION

#### 9. attack and decay control

The attack and decay circuitry alters the rise and fall times of the envelope selected by the envelope select logic. The attack/decay timing capacitor (CA/D) at pin 8 is shared by both the attack and decay circuitry. The attack control resistor (RA) at pin 10 sets an internal current that charges capacitor CA/D thereby determining the attack (rise) time of the envelope. The decay control resistor (RD) at pin 7 determines the discharge rate of capacitor CA/D and thus determines the decay (fall) time of the envelope. The actual times may be derived from the following equations:

Equation 6: Attack time (seconds)  $\approx RA \cdot CA/D$  at  $V_{reg} = 5 V$ .

Equation 7: Decay time (seconds)  $\approx RD \cdot CA/D$  at  $V_{reg} = 5 V$ .

If mixer only or one-shot has been chosen at the envelope select inputs, the attack ramp begins when the system inhibit (pin 9) is taken low. If VCO or VCO with alternating cycles is selected for the envelope, the attack ramps up on each positive edge or every other positive edge, respectively, of the VCO frequency. The decay section ramps the sound amplitude down as the sound ends. The decay has no effect on the mixer-only function, but for the one-shot, the VCO, and the VCO with alternating cycle envelopes, the decay ramp is triggered by each high-to-low transition of the envelope and prolongs the sound at a decaying volume.

Figure 5 shows examples of how a waveform may be modified by varying degrees of attack and decay when the mixer output is noise and the one-shot envelope is selected. Figure 6 shows examples of noise with a VCO envelope and attack and/or decay.

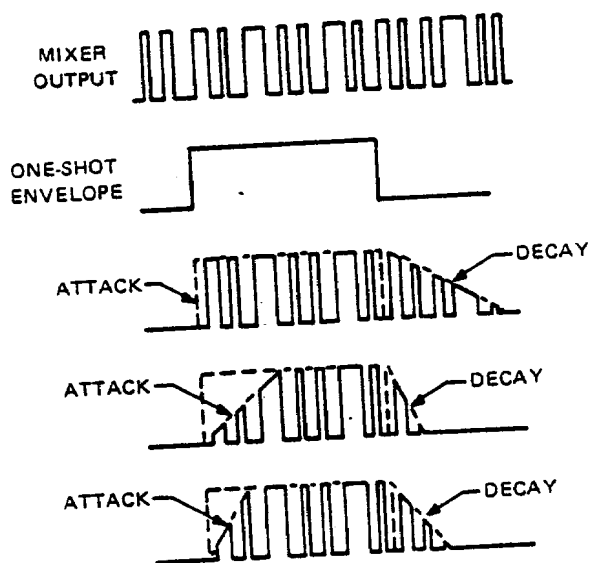

FIGURE 5

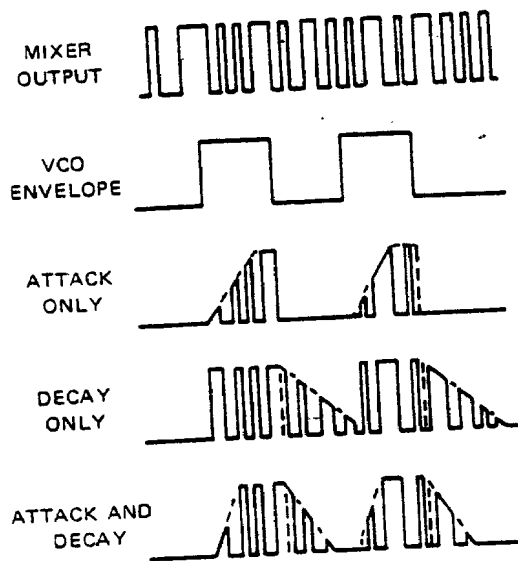

FIGURE 6

# TYPE SN76477 COMPLEX SOUND GENERATOR

---

## OPERATION

### 10. output amplifier

The output amplifier is designed to interface with sound modulators or additional amplifier stages. It requires an external feedback resistor ( $R_F$ ) from pin 12 to pin 13, and an amplitude control resistor ( $R_G$ ) from pin 11 to ground. It is designed as a low-impedance output. The peak output voltage is determined by the following equation:

$$\text{Equation 8: } V_{out} \approx \frac{3.4 R_F}{R_G} \text{ at } V_{reg} = 5 \text{ V.}$$

$R_G$  should be in the range of 47 k $\Omega$  to 220 k $\Omega$ .

The dynamic output range is limited to 2.5 volts peak-to-peak before clipping occurs. The output is an emitter-follower without a load resistor. Therefore pin 13 should have a pull-down resistor with a value ranging from 2.7 k $\Omega$  to 10 k $\Omega$ .

When an external audio amplifier is used with this device, pin 13 is connected to the input of the external amplifier, and feedback from the external amplifier is connected to pin 12. A typical external amplifier is shown in Figure 7.

### 11. regulator

The circuit will operate from either of two power supplies. A 5-volt regulated supply may be applied to  $V_{reg}$  (pin 15) with  $V_{CC}$  (pin 14) left open. However, an internal 5-volt regulator allows the use of a 7.5-volt to 10-volt unregulated supply applied to  $V_{CC}$  (pin 14) and in addition to supplying power for the chip, the internal regulator will provide a 5-volt regulated supply of up to 10 mA from  $V_{reg}$  (pin 15) for use outside the integrated circuit.

# TYPE SN76477 COMPLEX SOUND GENERATOR

## TYPICAL APPLICATION DATA

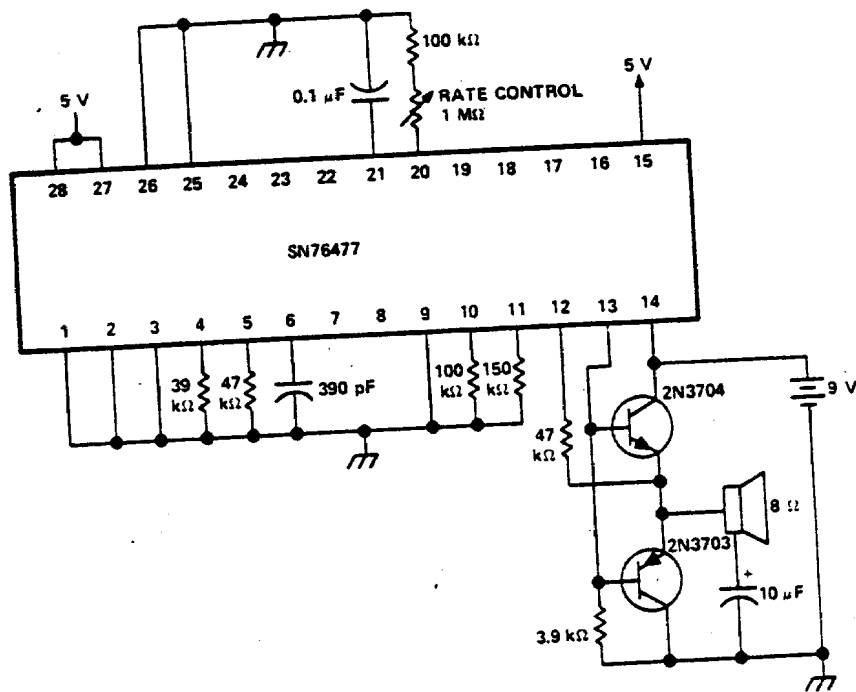
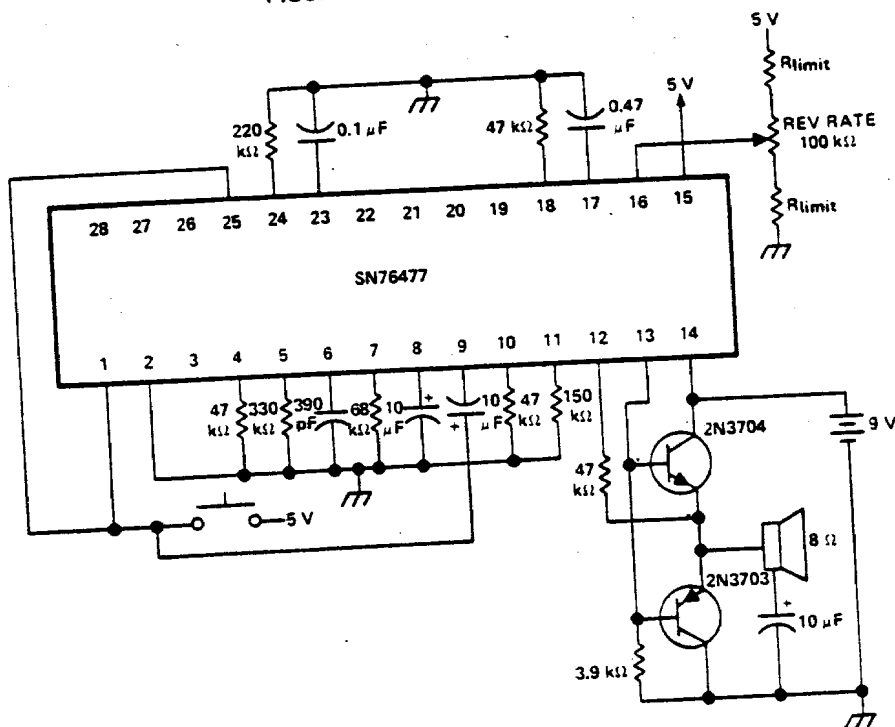

FIGURE 7—STEAM TRAIN/PROP PLANE



For two simultaneous race car sounds, the mixer can be multiplexed between the SLF and VCO functions.

FIGURE 8—RACE CAR MOTOR/CRASH

# TYPE SN76477 COMPLEX SOUND GENERATOR

## TYPICAL APPLICATION DATA

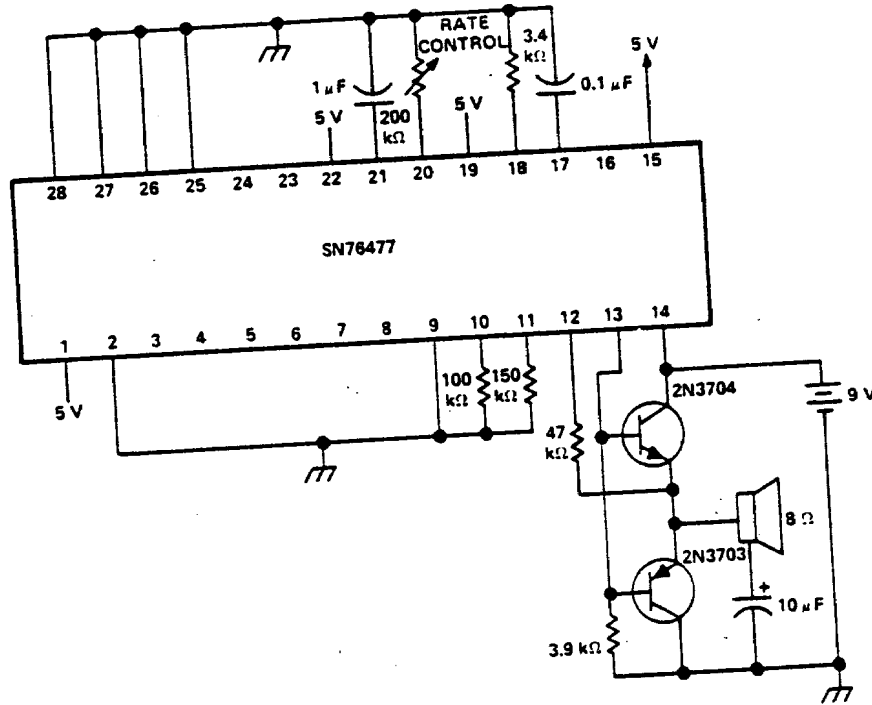

The one-shot and decay functions could be added to make an ideal phasor gun sound.

FIGURE 9—SIREN/SPACE WAR/PHASOR GUN

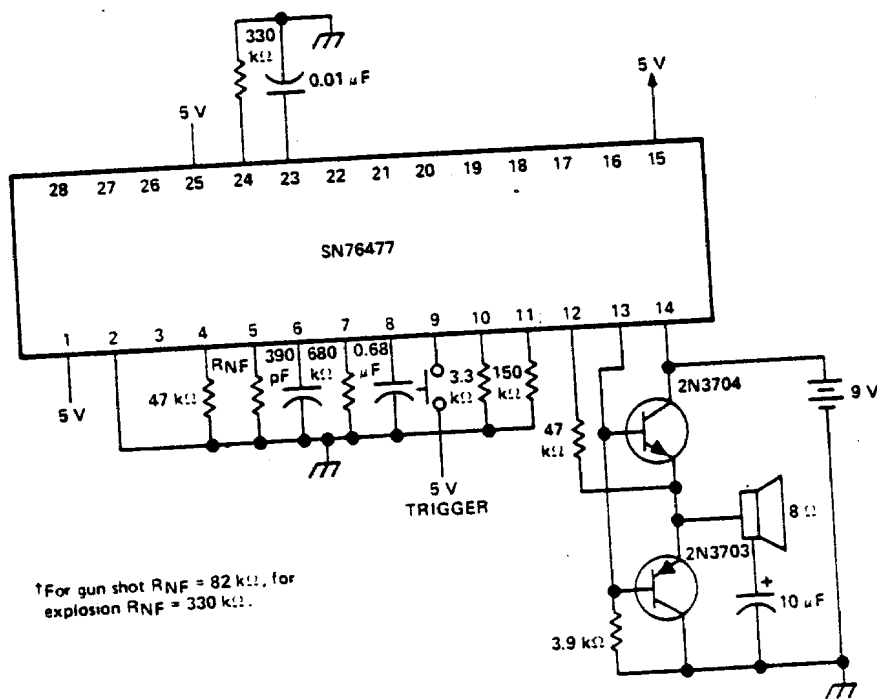

†For gun shot RNF = 82 k $\Omega$ , for explosion RNF = 330 k $\Omega$ .

FIGURE 10—GUNSHOT/EXPLOSION

# TYPE SN76477 COMPLEX SOUND GENERATOR

## TYPICAL APPLICATION DATA

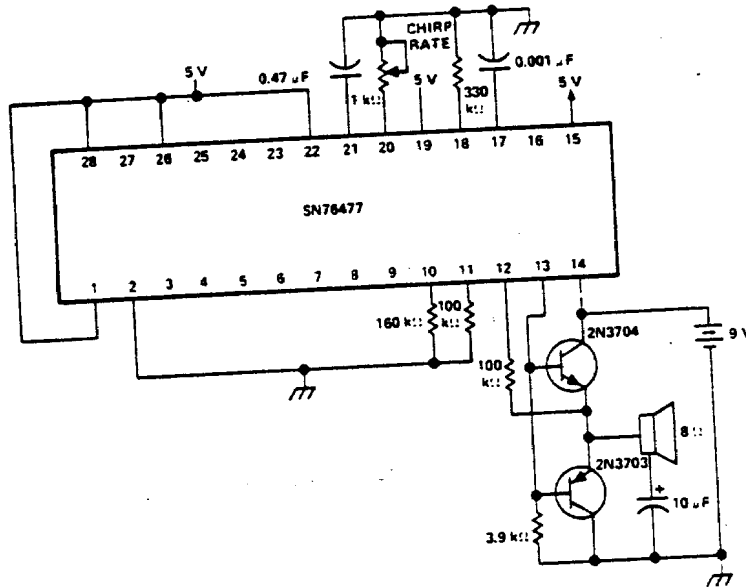

For barking dog, the capacitor at pin 17 is changed to 15 pF to increase the frequency of the VCO.

FIGURE 11—BIRD CHIRP

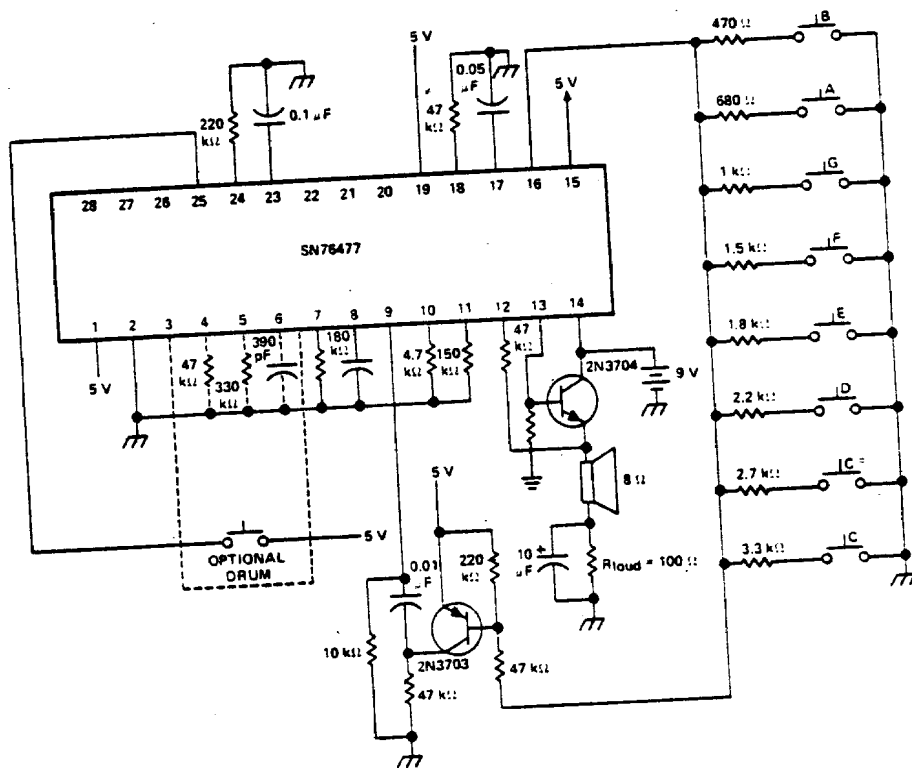
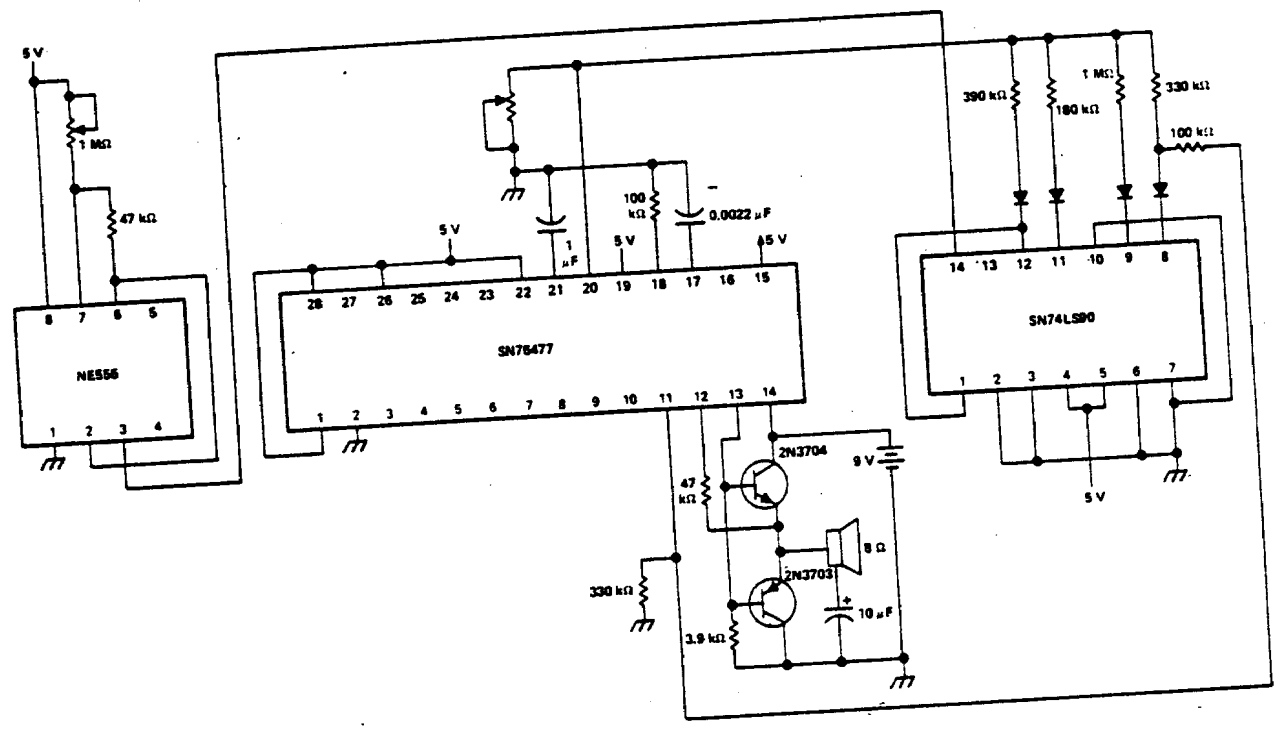

FIGURE 12—MUSICAL ORGAN

# TYPE SN76477 COMPLEX SOUND GENERATOR

## TYPICAL APPLICATION DATA



PROGRAMMABLE BIRD SOUNDS

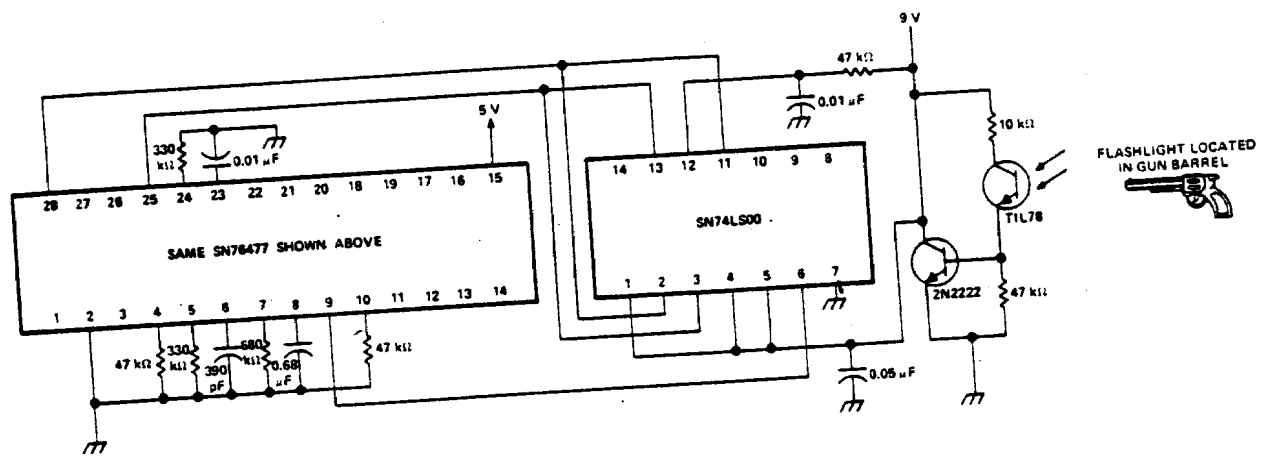

ADDITIONAL CIRCUITRY FOR SILENCER AND GUN SHOT (FOR USE WITH BIRD SOUNDS ABOVE)

FIGURE 13

# TYPE SN76477 COMPLEX SOUND GENERATOR

## TYPICAL APPLICATION DATA

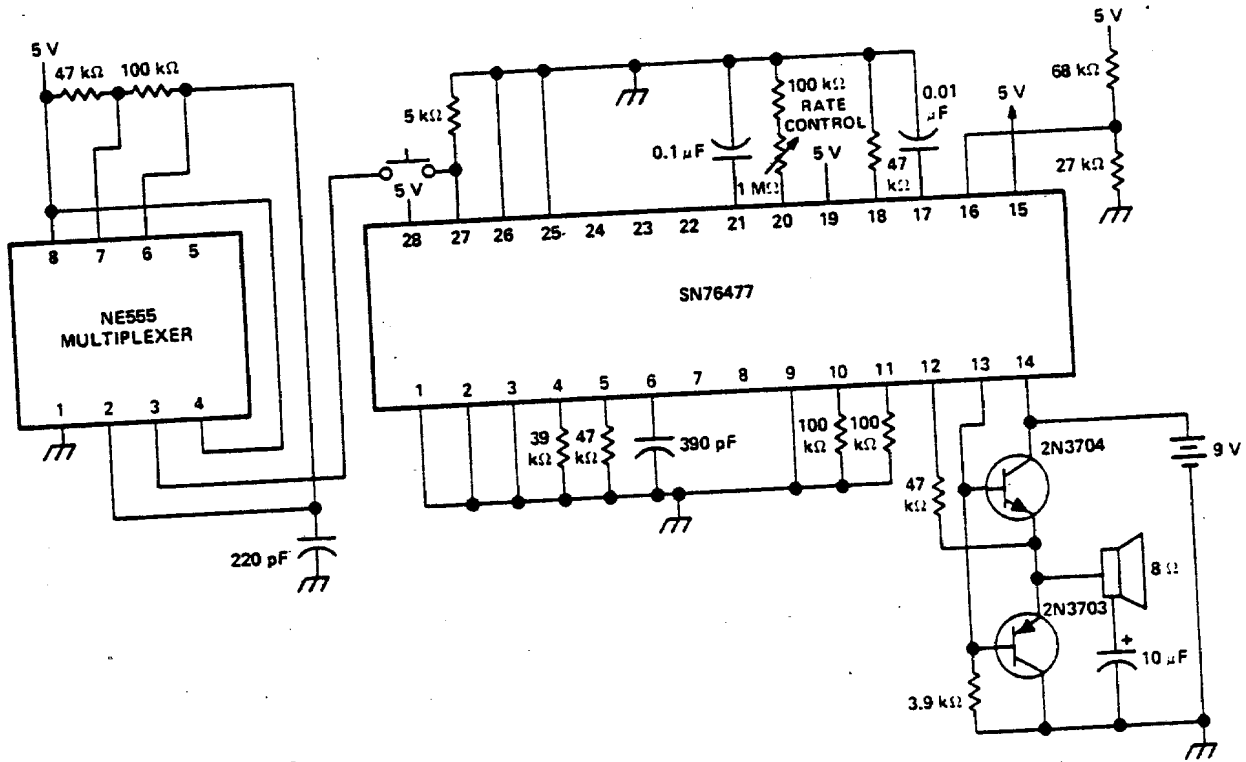

FIGURE 14—STEAM TRAIN WITH WHISTLE

# TYPE SN76477 COMPLEX SOUND GENERATOR

## ORDERING INSTRUCTIONS AND MECHANICAL DATA

### general

The SN76477 is available in the standard dual-in-line plastic package with 0.600-inch (15.24-mm) centers (outline N), or in the smaller dual-in-line plastic package with 0.400-inch (10.16-mm) centers (outline NF). Orders for these circuits should include the package outline letter(s) at the end of the type number; i.e., SN76477N or SN76477NF.

### N package

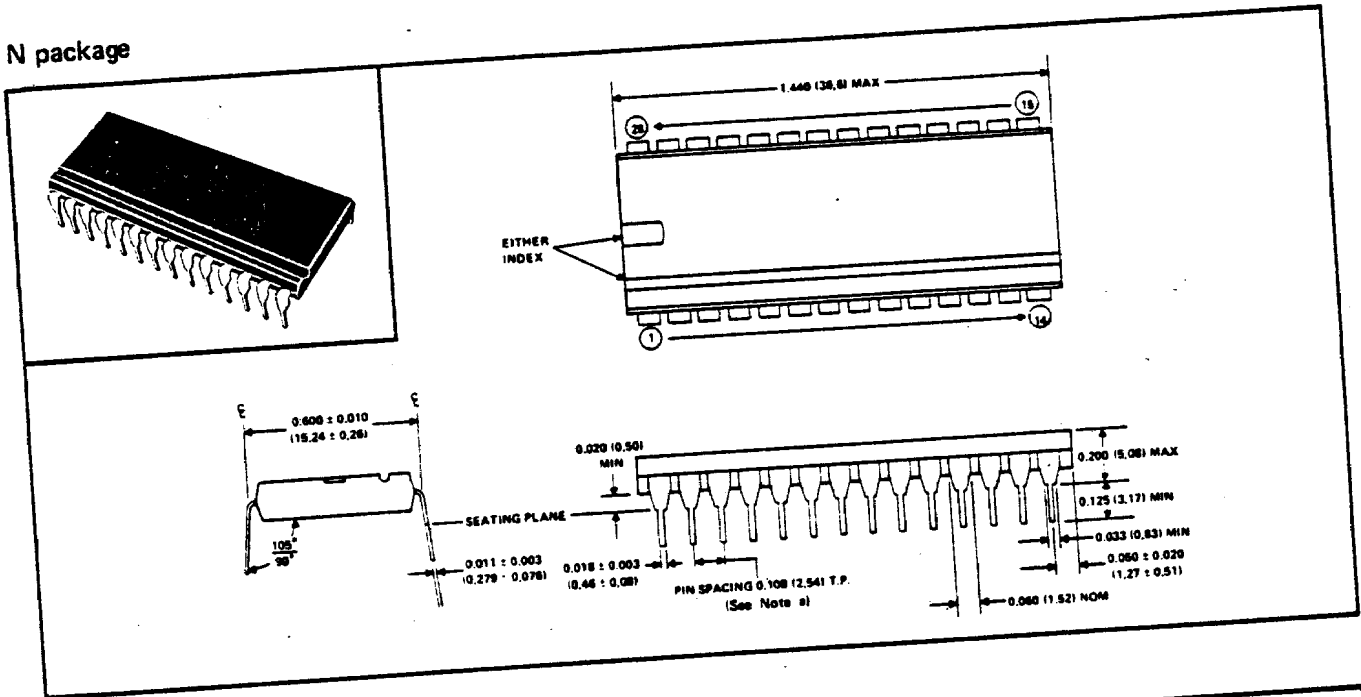

### NF package

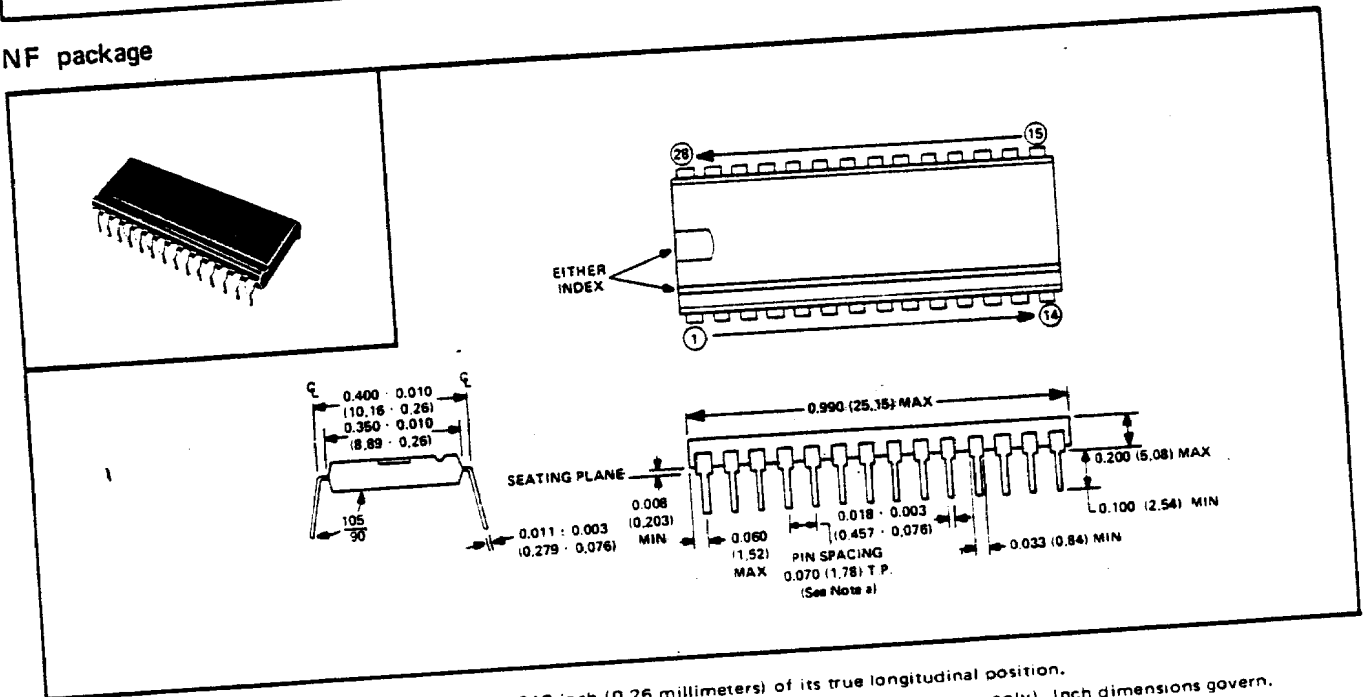

NOTES: a. Each pin centerline is located within 0.010 inch (0.26 millimeters) of its true longitudinal position.  
 b. All linear dimensions are shown in inches (and parenthetically in millimeters for reference only). Inch dimensions govern.



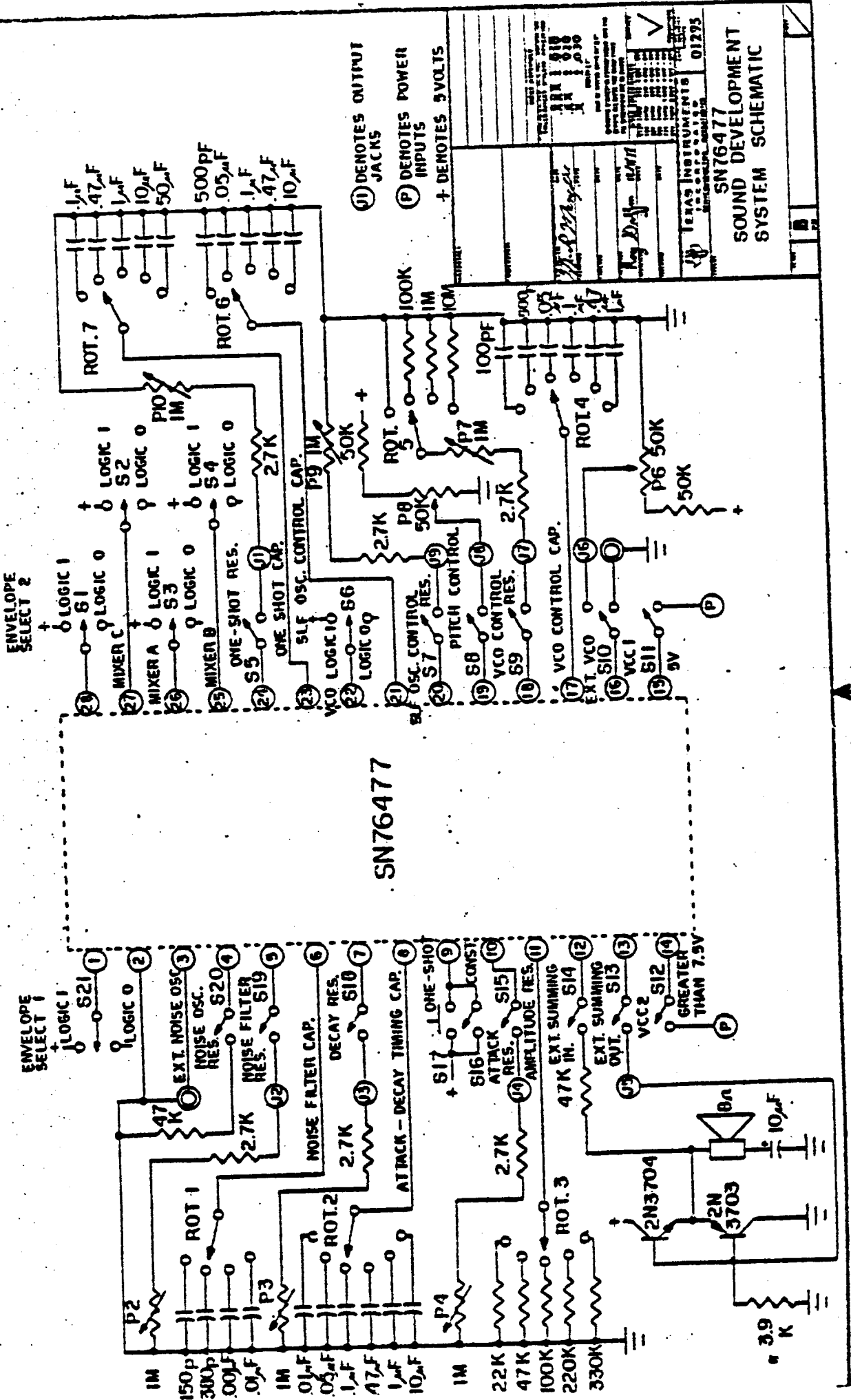

SN76477

SN76477  
SOUND DEVELOPMENT  
SYSTEM SCHEMATIC

3.9 K