

LOC	DIST	REVISIONS			
P	LTN	DESCRIPTION	DATE	DMN	APVD
ES	00				
A12		ECR-15-005722	14APR2015	KD	RR
A13		ECR-15-007260	19MAY2015	WW	RR
A14		ECR-15-008261	5JUN2015	KD	RR
A15		ECR-15-009807	30JUN2015	WW	RR

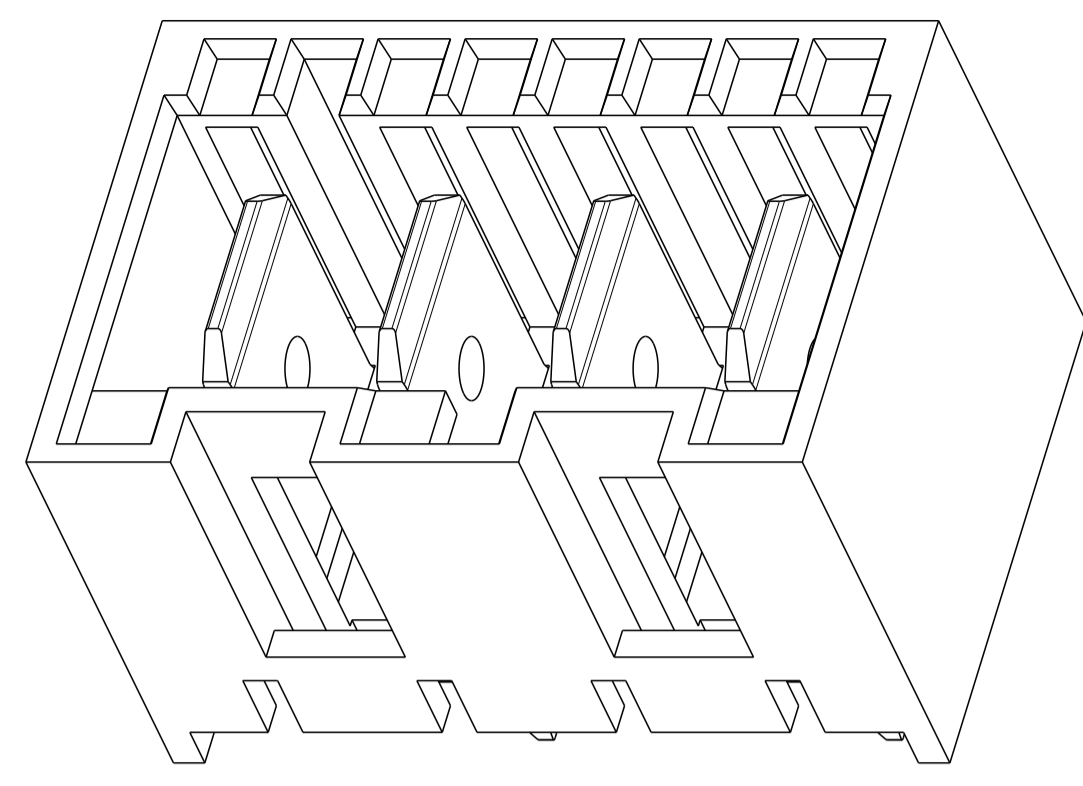

**NOTE**

- HOUSING HAS RAST 5 COMPLIANT KEYING, LATCHING, AND POLARIZATION. TAB IS 6.30 X 0.8 ACCORDING TO DIN 46244.
- SEE SHEET 2 FOR AVAILABLE CONFIGURATIONS.
- MATERIAL: HOUSING, NYLON, UL94 V0, 750°C GWT NO FLAME. CONTACT, COPPER ALLOY, 0.8MM THICK.
- FINISH: CONTACTS, MATT TIN PLATING OVERALL, NICKEL UNDER-PLATING. BRIGHT TIN PLATING OVERALL, NICKEL UNDER-PLATING. SILVER PLATING OVERALL, NICKEL UNDER-PLATING.
- PCB TABS INSERTED IN A STAGGERED PATTERN BEGINNING WITH POSITION 1 (Cct1).
- THE PART NUMBERS SHOWING IN SHEET 2 & 3 & 4 & 5 ARE FOR NATURAL COLOR. THE PART NUMBER FOR OTHER COLOR ARE BASED ON THE NATURAL ONE: FOR THE SAME CONFIGURATION, THE PREFIX AND POSTFIX OF THE P/N ARE THE SAME, ONLY THE BASE NUMBER IS DIFFERENT ACCORDING TO DIFFERENT COLOR, DETAIL PLEASE SEE SHEET 6.
- PACKAGING: LOOSE PIECE OR TUBE. THE PART NUMBERS IN THIS DRAWING ARE WITH LOOSE PIECE PACKAGING. PLEASE CONTACT TE SALES REPRESENTATIVES FOR TUBE PACKAGING REQUIREMENT.
- PRELIMINARY PART, NOT RELEASED FOR PRODUCTION.
- FOR P/N: 2-1971895-4:
  - THE CONTACTS ARE WITH BRIGHT TIN PLATING.
  - INSERTION FORCE MATING WITH 4P MONO SHAPE MKI CONNECTOR: 85N MAX ACCORDING TO IEC 60512-13-1, Test 13a.
- FOR P/N: 5-1971845-8, 2-1971845-6 AND 6-1971845-5:
  - THE CONTACTS ARE WITH BRIGHT TIN PLATING.

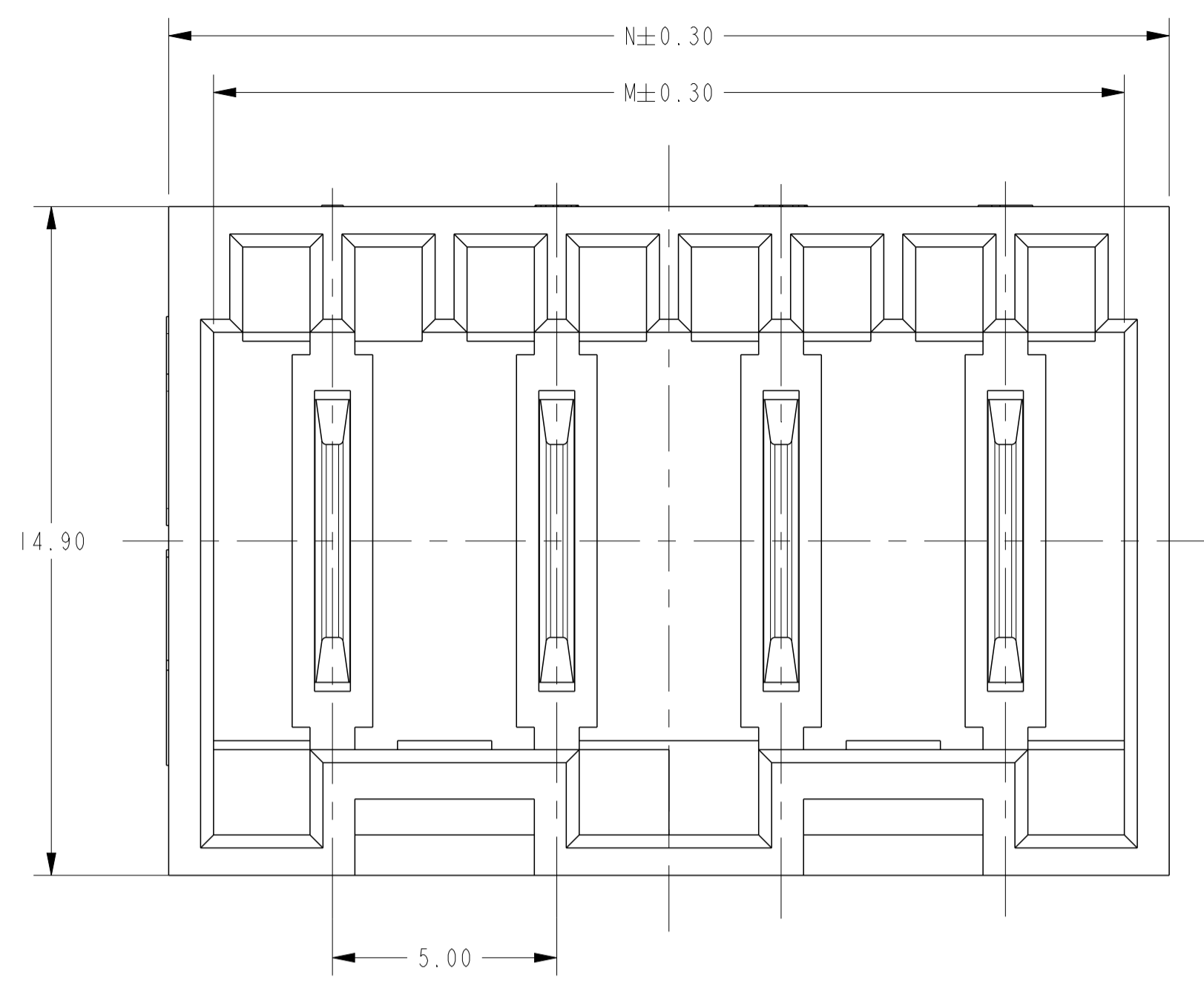
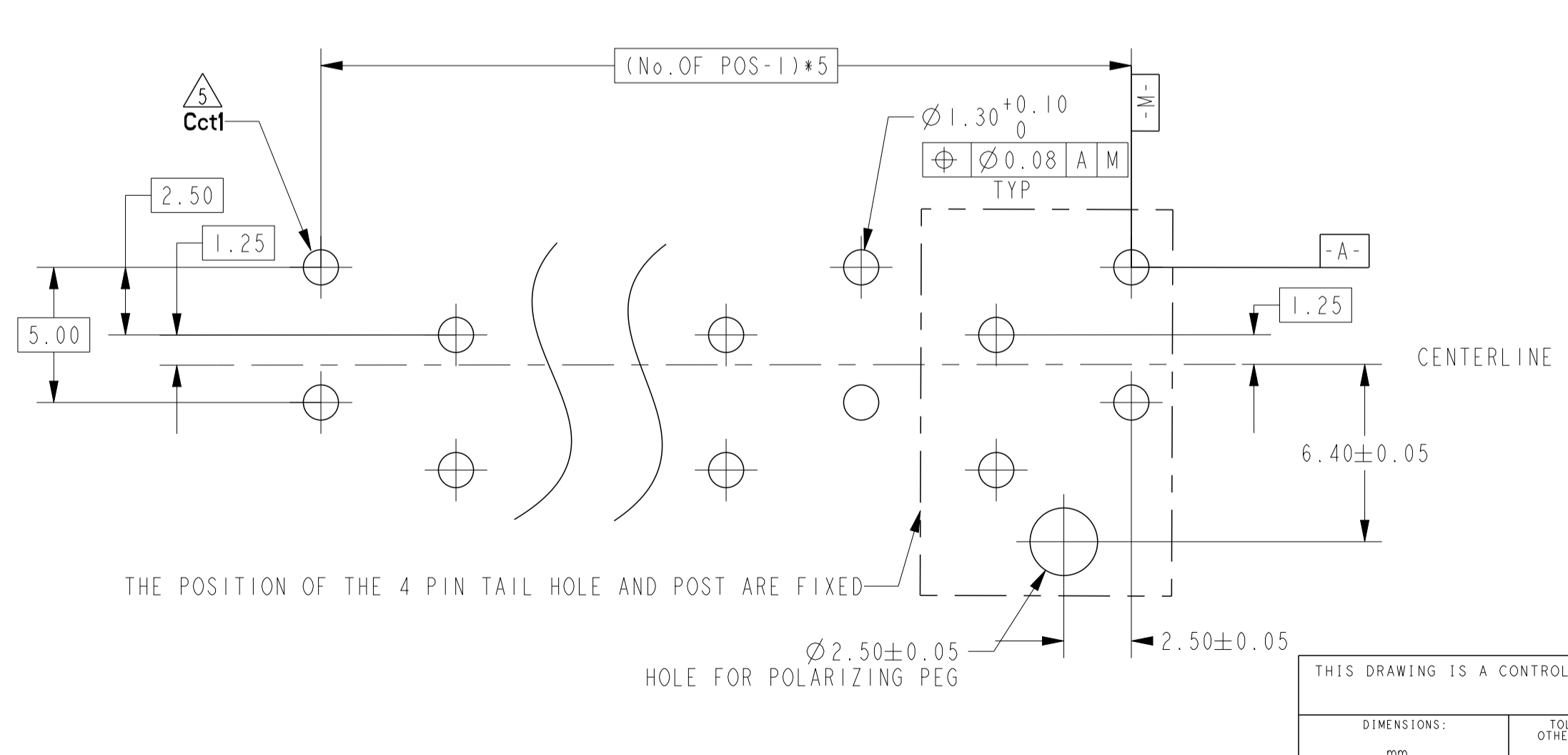
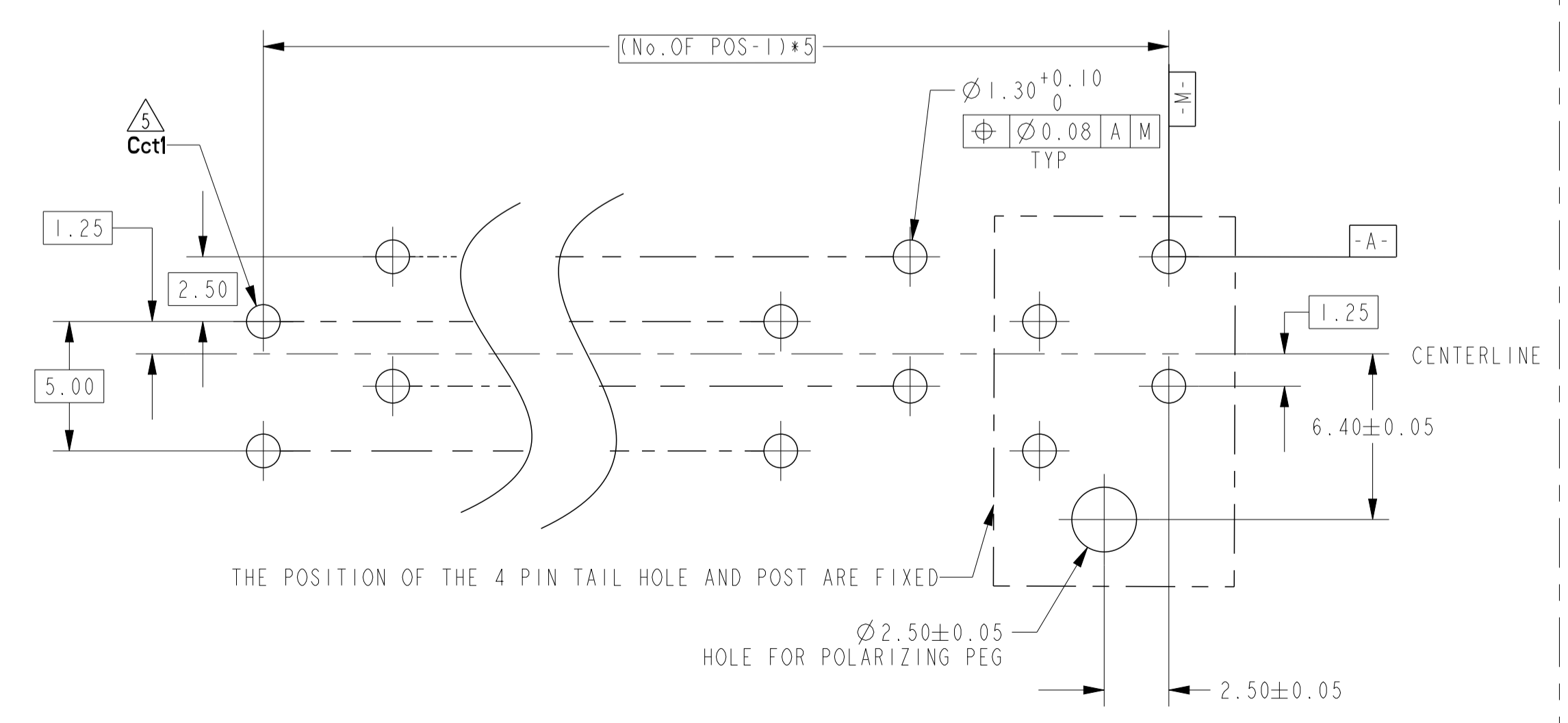
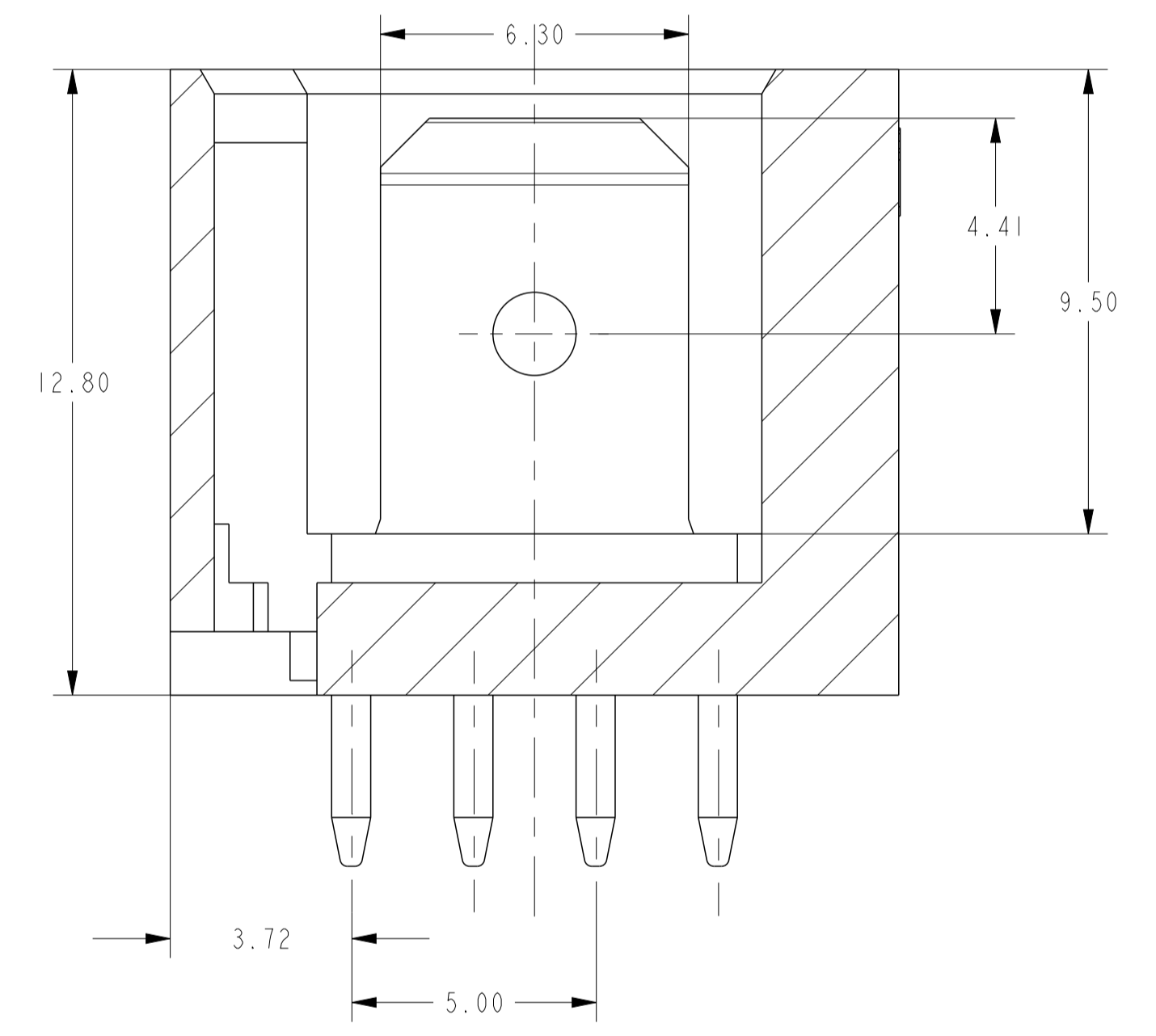
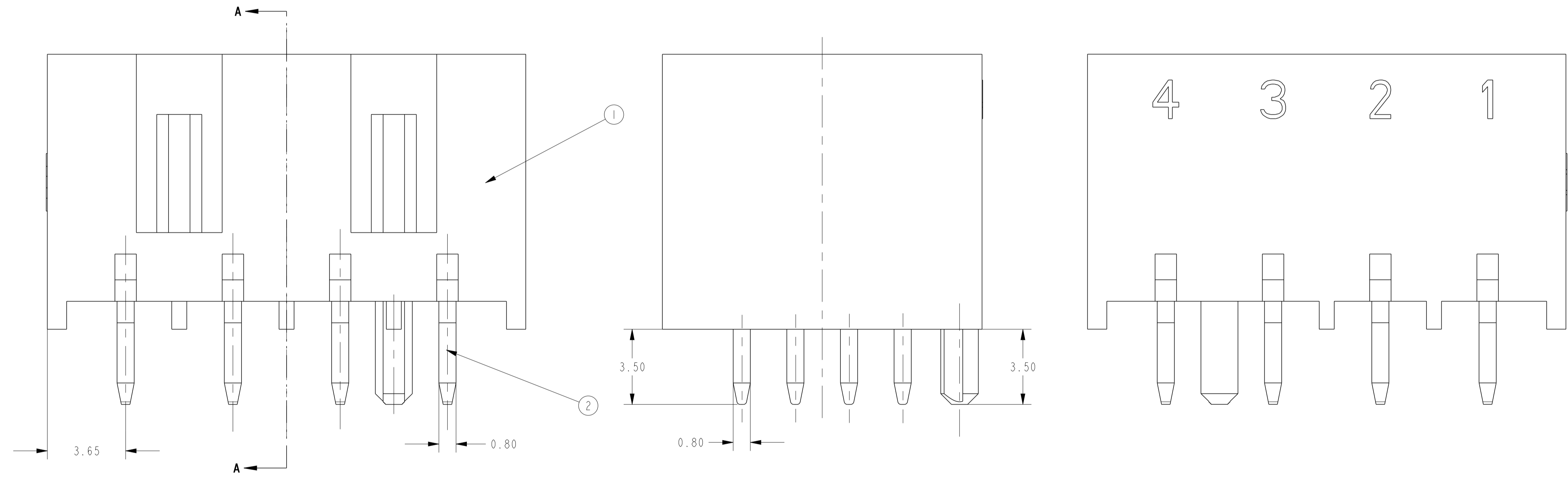

42.30	40.30	8
37.30	35.30	7
32.30	30.30	6
27.30	25.30	5
22.30	20.30	4
17.30	15.30	3
12.30	10.30	2
N	M	NO. OF POS.

RECOMMEND PCB LAYOUT - SOLDER SIDE  
EVEN NUMBER OF PINS  
PCB 15±0.2 THICK

RECOMMEND PCB LAYOUT - SOLDER SIDE  
ODD NUMBER OF PINS  
PCB 15±0.2 THICK

THIS DRAWING IS A CONTROLLED DOCUMENT.

DMN	WRP	21Jan2013
CHK	HAPYE	21Jan2013
APVD	YHM	21Jan2013

TE Connectivity

NAME: RAST 5 TAB HEADER ASSY  
DIN STYLE, TH, VERTICAL

SIZE: A1  
CAGE CODE: 00779  
DRAWING NO: 1971845

Customer Drawing

SCALE: N/A  
SHEET: 1 OF 6  
REV: A15

LOC		DIST		REVISIONS			
ES	00	P	LTN	DESCRIPTION	DATE	OWN	APVD
-	-	-	-	SEE SHEET 1	-	-	-

color	QTY	②	QTY	①	NO. OF POS.	TE PART NO.
RED	8	TAB CCONTACT MATT TIN PLATING (5-1971845-8, 6-1971845-5 AND 2-1971845-6 ARE WITH BRIGHT TIN)	1	RAST 5 TAB HEADER HOUSING, 8P. (SEE THE DETAIL LAYOUT ON SHEET 5)	8	6-1971845-8
						⑧ 5-1971845-8 ⑩
						4-1971845-8
						3-1971845-8
						2-1971845-8
						1-1971845-8
						1971845-8
						1971946-7
						1971895-7
						9-1971845-7
		8-1971845-7				
		7-1971845-7				
		6-1971845-7				
		5-1971845-7				
		4-1971845-7				
		3-1971845-7				
		2-1971845-7				
		1-1971845-7				
		1971845-7				
		1-1971895-6				
		1971895-6				
		9-1971845-6				
		8-1971845-6				
		7-1971845-6				
		6-1971845-6				
		5-1971845-6				
		4-1971845-6				
		3-1971845-6				
		2-1971845-6 ⑩				
		1-1971845-6				
		1971845-6				
		1971954-5				
		1-1971895-5				
		1971895-5				
		9-1971845-5				
		8-1971845-5				
		7-1971845-5				
		6-1971845-5 ⑩				
		5-1971845-5				
		4-1971845-5				
		3-1971845-5				
		2-1971845-5				
		1-1971845-5				
		1971845-5				

color	QTY	②	QTY	①	NO. OF POS.	TE PART NO.
GREEN	4	TAB CCONTACT w/ MATT TIN PLATING (2-1971895-4 IS WITH BRIGHT TIN)	1	RAST 5 TAB HEADER HOUSING, 4P (SEE THE DETAIL LAYOUT ON SHEET 4)	4	1971962-4
						9-1971895-4
						8-1971895-4 ⑧
						7-1971895-4
						6-1971895-4
						5-1971895-4
						4-1971895-4
						3-1971895-4
						2-1971895-4 ⑨
						1-1971895-4
		1971895-4				
		9-1971845-4				
		8-1971845-4				
		7-1971845-4				
		6-1971845-4				
		5-1971845-4				
		4-1971845-4				
		3-1971845-4				
		2-1971845-4				
		1-1971845-4				
		1971845-4				
		4-1971895-3				
		3-1971895-3				
		2-1971895-3				
		1-1971895-3				
		1971895-3				
		9-1971845-3				
		8-1971845-3				
		7-1971845-3				
		6-1971845-3				
		5-1971845-3				
		4-1971845-3				
		3-1971845-3				
		2-1971845-3				
		1-1971845-3				
		1971845-3				
		6-1971895-2				
		5-1971895-2				
		4-1971895-2				
		3-1971895-2				
		2-1971895-2				
		1-1971895-2				
		1971895-2				
		9-1971845-2				
		8-1971845-2				
		7-1971845-2				
		6-1971845-2				
		5-1971845-2				
		4-1971845-2				
		3-1971845-2				
		2-1971845-2				
		1-1971845-2				
		1971845-2				

THIS DRAWING IS A CONTROLLED DOCUMENT.

OWN: HRP 21Jan2013  
 CHK: HAPYE\_WU 21Jan2013  
 APVD: YIM 21Jan2013

TE Connectivity

NAME: RAST 5 TAB HEADER ASSY  
 DIN STYLE, TH, VERTICAL

SIZE: A1 CAGE CODE: 00779 DRAWING NO: 1971845

SCALE: N/A SHEET 2 OF 6 REV: A1.5

RESTRICTED TO: -

CUSTOMER DRAWING

LOC		DIST		REVISIONS			
P	LTN	DATE	OWN	APVD			
-	SEE SHEET 1	-	-	-			

color	QTY	②	QTY	①	NO. OF POS.	TE PART NO.
natural	8	1	1	8	8	6-1971846-8
						5-1971846-8
						4-1971846-8
						3-1971846-8
natural	7	1	1	7	7	2-1971846-8
						1-1971846-8
						1971846-8
						1971896-7
						9-1971846-7
						8-1971846-7
						7-1971846-7
						6-1971846-7
						5-1971846-7
						4-1971846-7
						3-1971846-7
						2-1971846-7
natural	6	1	1	6	6	1-1971846-7
						1-1971896-6
						1971896-6
						9-1971846-6
						8-1971846-6
						7-1971846-6
						6-1971846-6
						5-1971846-6
						4-1971846-6
						3-1971846-6
						2-1971846-6
						1-1971846-6
natural	5	1	1	5	5	1971846-6
						1971896-5
						9-1971846-5
						8-1971846-5
						7-1971846-5
						6-1971846-5
						5-1971846-5
						4-1971846-5
						3-1971846-5
						2-1971846-5
						1-1971846-5
						1971846-5

color	QTY	②	QTY	①	NO. OF POS.	TE PART NO.
natural	4	1	1	4	4	9-1971896-4
						7-1971896-4
						6-1971896-4
						5-1971896-4
natural	3	1	1	3	3	4-1971896-4
						3-1971896-4
						2-1971896-4
						1-1971896-4
						1971896-4
						9-1971846-4
						8-1971846-4
						7-1971846-4
						6-1971846-4
						5-1971846-4
						4-1971846-4
						3-1971846-4
2-1971846-4						
natural	2	1	1	2	2	1-1971846-4
						1971846-4
						4-1971896-3
						3-1971896-3
						2-1971896-3
						1-1971896-3
						1971896-3
						9-1971846-3
						8-1971846-3
						7-1971846-3
						6-1971846-3
						5-1971846-3
4-1971846-3						
3-1971846-3						
2-1971846-3						
1-1971846-3						
1971846-3						
natural	1	1	1	1	1	6-1971896-2
						5-1971896-2
						4-1971896-2
						3-1971896-2
						2-1971896-2
						1-1971896-2
						1971896-2
						9-1971846-2
						8-1971846-2
						7-1971846-2
						6-1971846-2
						5-1971846-2
4-1971846-2						
3-1971846-2						
2-1971846-2						
1-1971846-2						
1971846-2						

THIS DRAWING IS A CONTROLLED DOCUMENT. DWN: HRP 21Jan2013  
 CHK: HAPYE\_WU 21Jan2013  
 APVD: YHM 21Jan2013

**STE** TE Connectivity

NAME: RAST 5 TAB HEADER ASSY  
 DIN STYLE, TH, VERTICAL

SIZE: A1 CAGE CODE: 00779 DRAWING NO: 1971845  
 WEIGHT: - RESTRICTED TO: -

CUSTOMER DRAWING SCALE: N/A SHEET 3 OF 6 REV: A15

LOC	DIST	REV	DATE	BY	APPV
ES	00				
REVISIONS			DATE	BY	APPV
SEE SHEET 1					

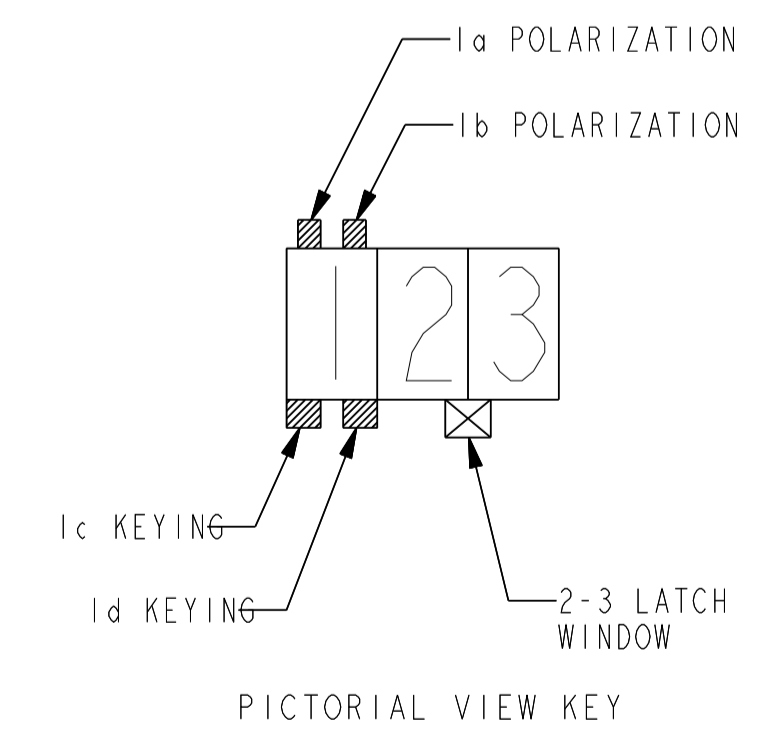

THIS DRAWING IS A CONTROLLED DOCUMENT.		OWN: HRP 21Jan2013	STC Connectivity NAME: RAST 5 TAB HEADER ASSY DIN STYLE, TH, VERTICAL
DIMENSIONS: mm		CHK: HAPYE_WU 21Jan2013	
TOLERANCES UNLESS OTHERWISE SPECIFIED:		APVD: YHM 21Jan2013	SIZE: A1
0 PLC ±		PRODUCT SPEC	CAGE CODE: 00779
1 PLC ±0.25		APPLICATION SPEC	DRAWING NO: 1971845
2 PLC ±		WEIGHT	RESTRICTED TO: -
3 PLC ±		CUSTOMER DRAWING	SCALE: N/A
4 PLC ±			SHEET: 4 OF 6
ANGLES ±2°			REV: A15
FINISH			

LOC		DIST		REVISIONS			
ES	00	P	LYN	DESCRIPTION	DATE	DWN	APVD
-	-	-	-	SEE SHEET 1	-	-	-

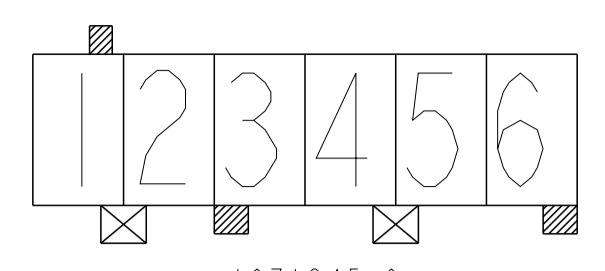

1971845-6  
1971846-6

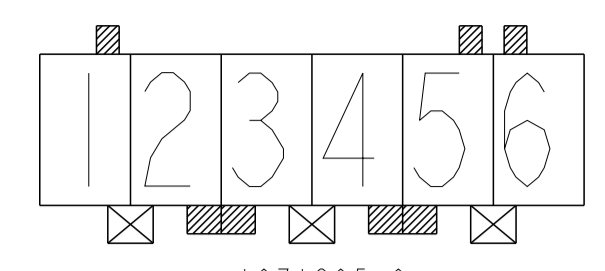

1971895-6  
1971896-6

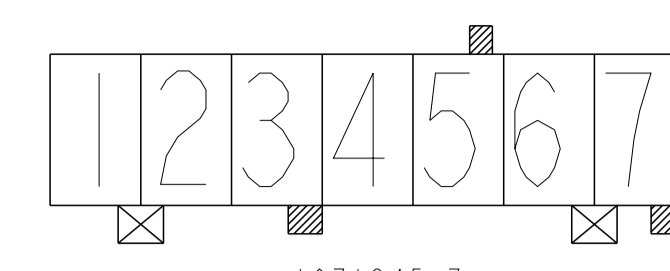

1971845-7  
1971846-7

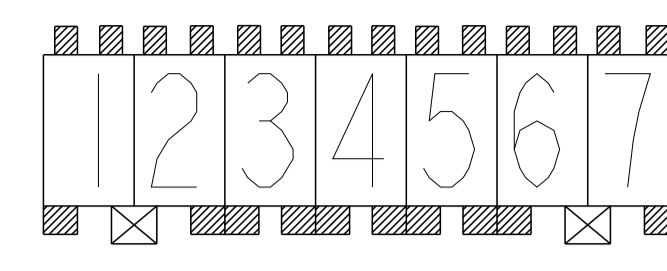

1971895-7  
1971896-7

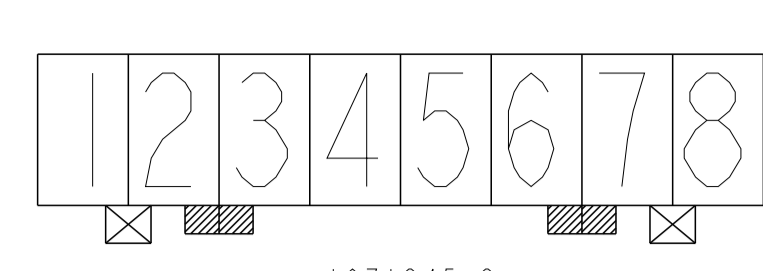

1971845-8  
1971846-8

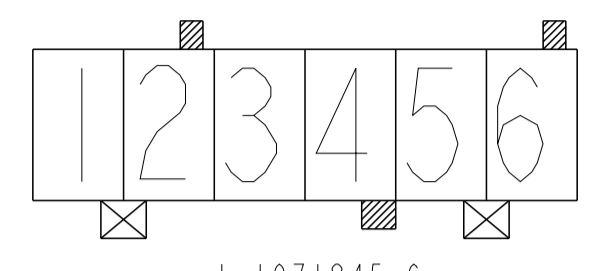

1-1971845-6  
1-1971846-6

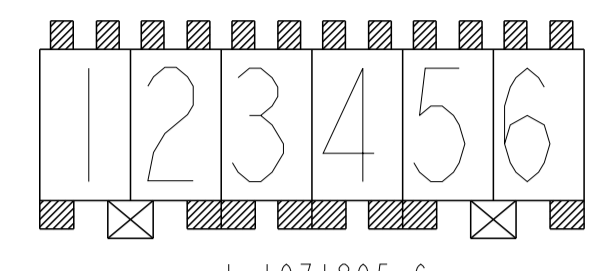

1-1971895-6  
1-1971896-6

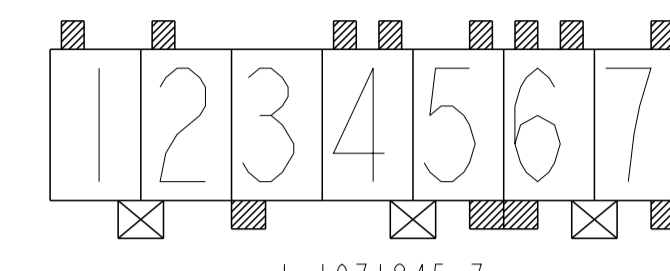

1-1971845-7  
1-1971846-7

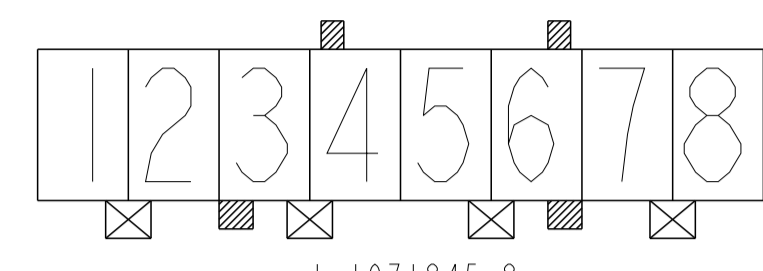

1-1971845-8  
1-1971846-8

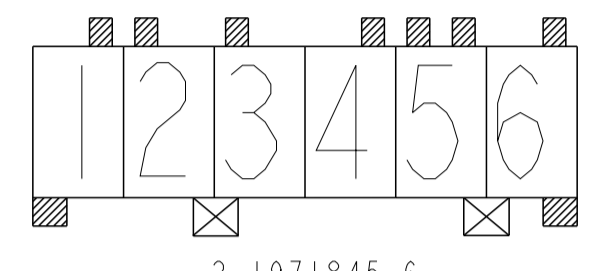

2-1971845-6  
2-1971846-6

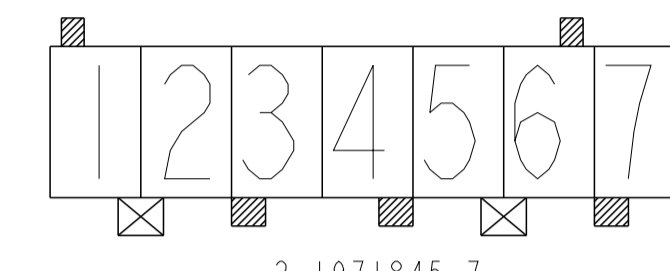

2-1971845-7  
2-1971846-7

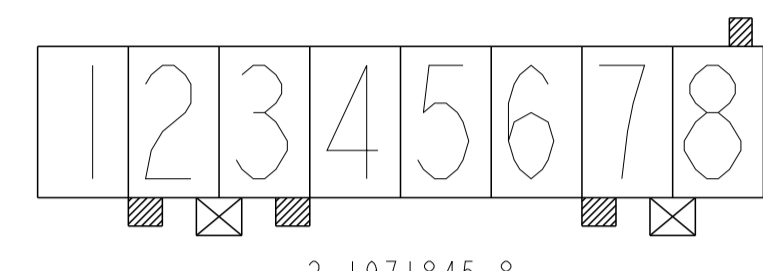

2-1971845-8  
2-1971846-8

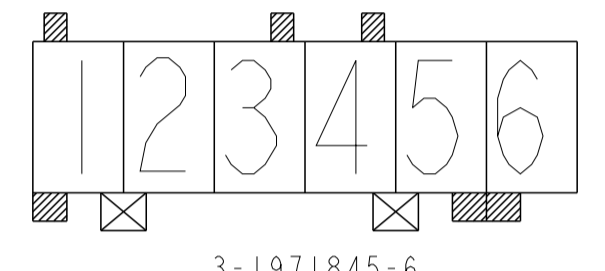

3-1971845-6  
3-1971846-6

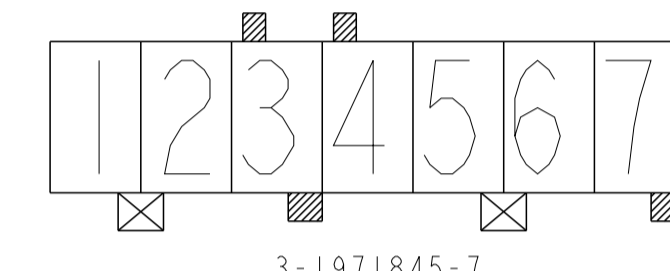

3-1971845-7  
3-1971846-7

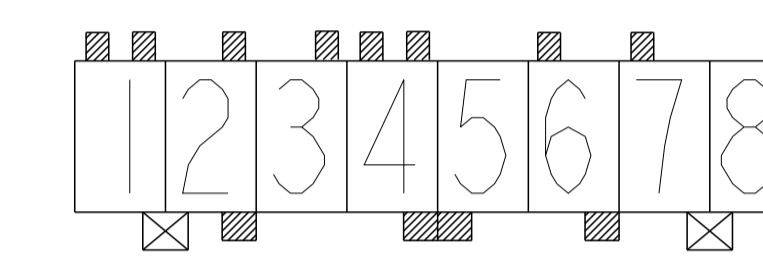

3-1971845-8  
3-1971846-8

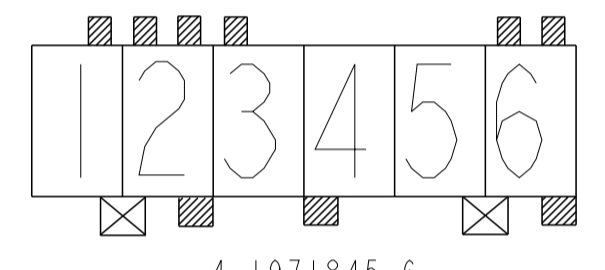

4-1971845-6  
4-1971846-6

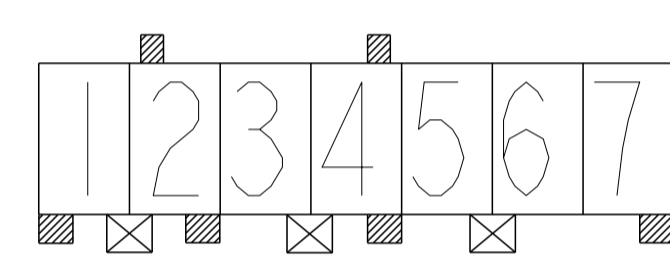

4-1971845-7  
4-1971846-7

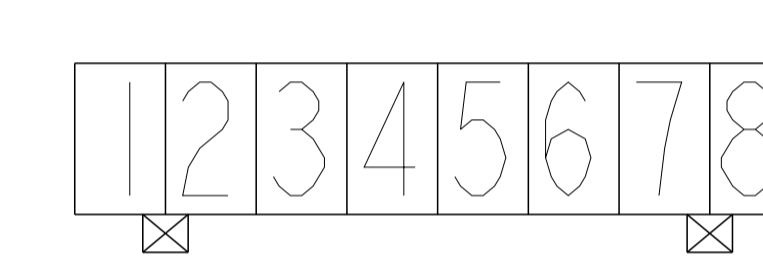

4-1971845-8  
4-1971846-8

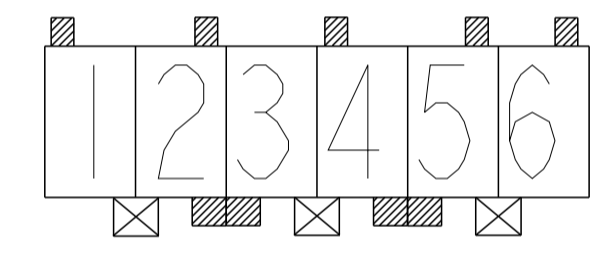

5-1971845-6  
5-1971846-6

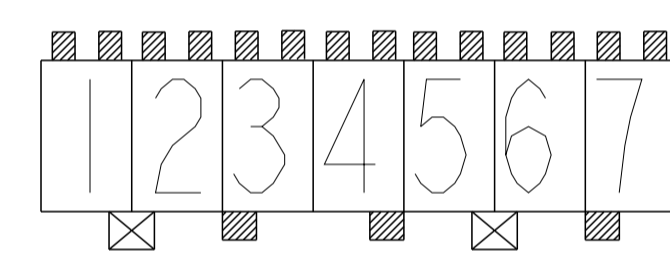

5-1971845-7  
5-1971846-7

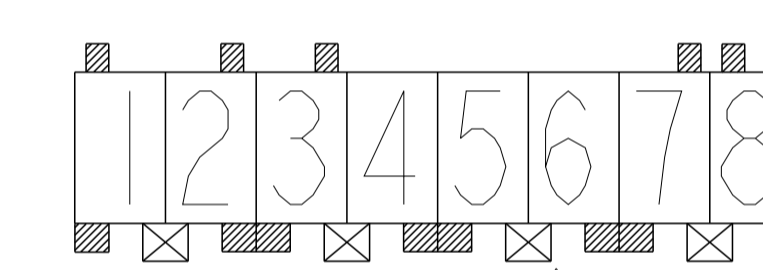

5-1971845-8  
5-1971846-8

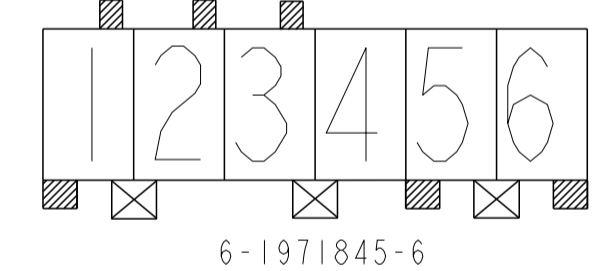

6-1971845-6  
6-1971846-6

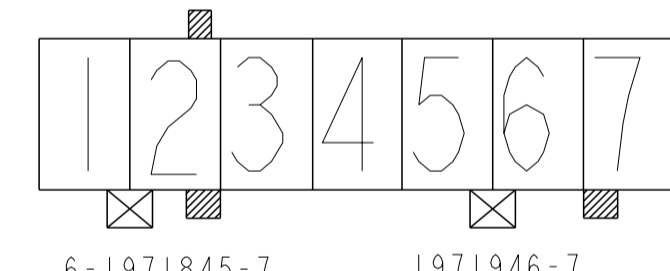

6-1971845-7  
1971946-7

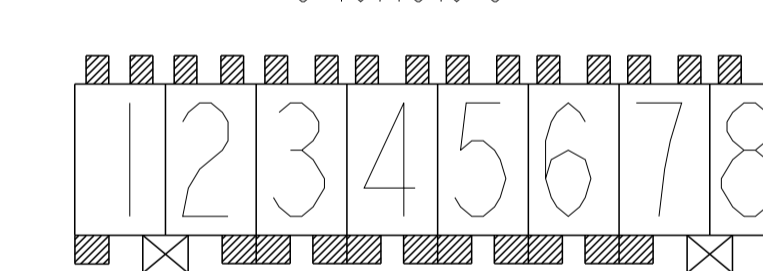

6-1971845-8  
6-1971846-8

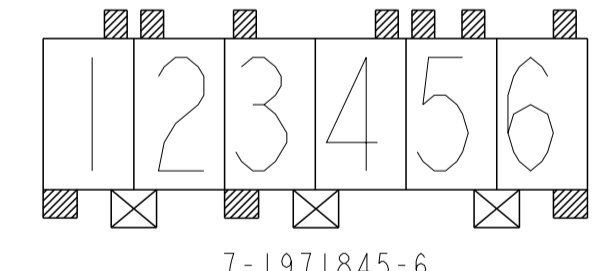

7-1971845-6  
7-1971846-6

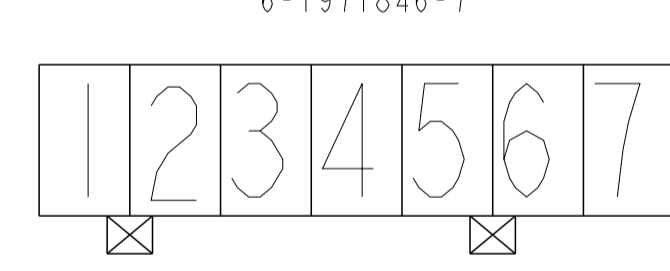

7-1971845-7  
7-1971846-7

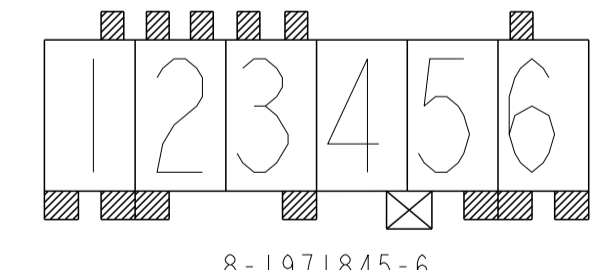

8-1971845-6  
8-1971846-6

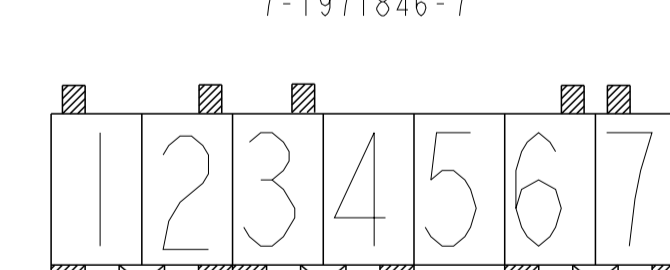

8-1971845-7  
8-1971846-7

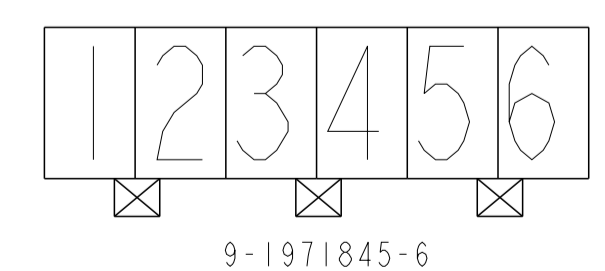

9-1971845-6  
9-1971846-6

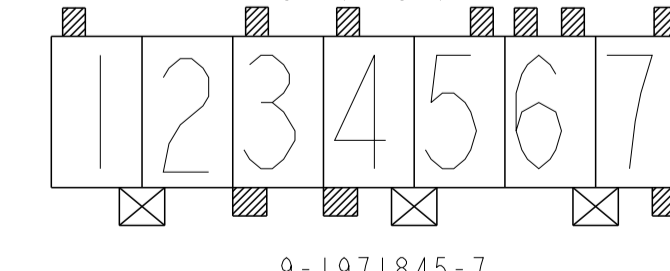

9-1971845-7  
9-1971846-7

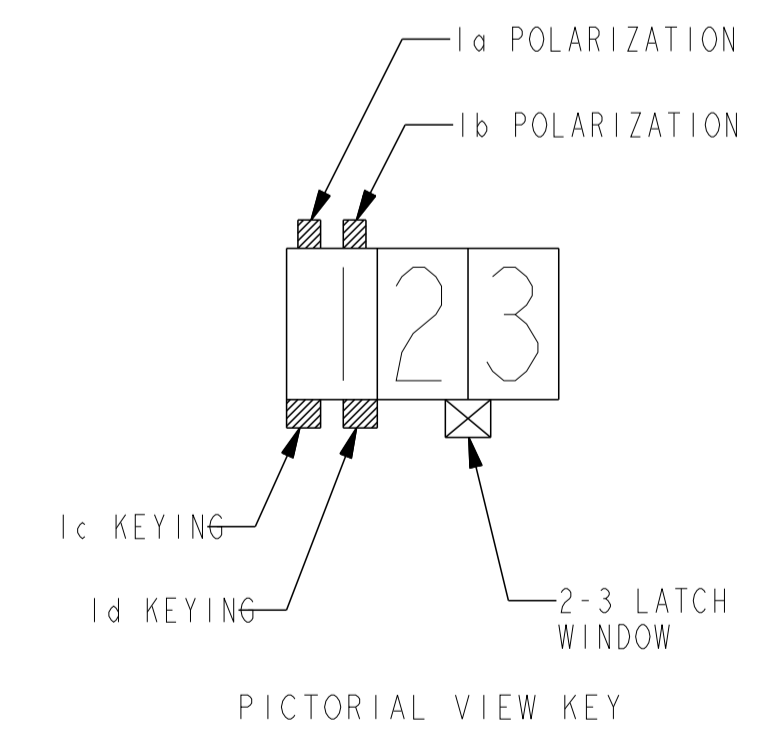

THIS DRAWING IS A CONTROLLED DOCUMENT.		DWN: WRP 21Jan2013	TE Connectivity NAME: RAST 5 TAB HEADER ASSY DIN STYLE, TH, VERTICAL
DIMENSIONS: mm		CHK: HAPYE_WU 21Jan2013	
TOLERANCES UNLESS OTHERWISE SPECIFIED:		APVD: YHM 21Jan2013	SIZE: A1
0 PLC ±	1 PLC ±	PRODUCT SPEC	CAGE CODE: 00779
2 PLC ±0.25	3 PLC ±	APPLICATION SPEC	DRAWING NO: 1971845
4 PLC ±	ANGLES ±	FINISH ±	RESTRICTED TO:
MATERIAL:		WEIGHT:	SCALE: N/A
CUSTOMER DRAWING		SCALE: N/A	SHEET 5 OF 6 REV: A15

LOC	DIST	REVISIONS					
ES	00	P	LTN	DESCRIPTION	DATE	OWN	APVD
		-		SEE SHEET 1			

FOR ANY KEYING CONFIGURATION, THERE ARE EIGHT COLORS AVAILABLE, BESIDES THE NATURAL COLOR. THERE ARE OTHER SEVEN COLORS, INCLUDE: YELLOW, BLUE, GREY, PURPLE, RED, GREEN, BLACK. THE WHITE VERSION IS PRELIMINARY. THE P/N OF THE COLOR CONNECTOR ARE BASED ON THE NATURAL CONNECTOR. THE PREFIX AND POSTFIX ARE THE SAME FOR THE SAME KEYING CONFIGURATION, BUT THE BASE NUMBERS ARE DIFFERENT ACCORDING TO DIFFERENT COLOR. THE FOLLOWING SHOWS WHAT'S THE P/N FOR COLOR CONNECTOR



COLOR	PART NUMBER OF THE CONNECTOR				COMMENTS
	WITH MATT TIN PLATING CONTACT (SPECIAL P/N: 2-1971895-4, 2-1971845-6, 6-1971845-5 AND 5-1971845-8 ARE WITH BRIGHT TIN)		WITH AG PLATING CONTACT		
NATURAL	#-1971845-#	#-1971895-#	#-1971846-#	#-1971896-#	THE DETAIL P/N FOR DIFFERENT KEYING SEE SHEET 2-5
RED	#-1971946-#	#-1971948-#	#-1971947-#	#-1971949-#	THE PREFIX AND POSTFIX ARE THE SAME WITH THE P/N OF THE NATURAL CONNECTOR FOR THE SAME KEYING, POLARIZATION, LATCH WINDOW CONFIGURATION. JUST THE BASE NUMBERS ARE DIFFERENT BASED ON DIFFERENT COLOR. # CAN BE THE NUMBER FROM 0 TO 9. BUT THERE ARE TWO EXEMPTION PART NUMBERS. 1971954-5 (BLUE) AND 1971946-7 (RED)
BLUE	#-1971954-#	#-1971956-#	#-1971955-#	#-1971957-#	
YELLOW	#-2232008-#	#-2232010-#	#-2232009-#	#-2232011-#	
BLACK	#-2232000-#	#-2232002-#	#-2232001-#	#-2232003-#	
GREY	#-2232016-#	#-2232018-#	#-2232017-#	#-2232019-#	
GREEN	#-1971962-#	#-1971964-#	#-1971963-#	#-1971965-#	
PURPLE	#-2232024-#	#-2232026-#	#-2232025-#	#-2232027-#	
WHITE	#-2232289-#	#-2232291-#	#-2232290-#	#-2232292-#	

THERE ARE TWO EXEMPTION FOR COLOR PART NUMBERS



FOR EXAMPLE, IF A CONNECTOR WITH THE CONFIGURATION AS BELOW, AND WITH MATT TIN PLATING CONTACT, IN THE SHEET 4, WE CAN FIND THE RELATED CONNECTOR P/N WITH NATURAL COLOR IS 1-1971845-4, THEN WE CAN LOOK IN THE ABOVE TABLE TO FIND THE CONNECTOR P/N WITH RED COLOR IS 1-1971946-3



COLOR	PART NUMBER OF THE CONNECTOR		COMMENTS
	WITH BRIGHT TIN PLATING CONTACT		
NATURAL	#-2232906-#	#-2232907-#	THE KEYING, POLARIZATION AND LATCH WINDOW CONFIGURATION ARE SAME AS THE MATT TIN CONNECTOR WITH THE SAME PREFIX AND POSTFIX FOR EACH COLOR. FOR EXAMPLE: 2232906-4 AND 1971845-4 HAVE SAME KEYING, POLARIZATION AND LATCH WINDOW CONFIGURATION. 2232907-4 AND 1971895-4 HAVE SAME KEYING, POLARIZATION AND LATCH WINDOW CONFIGURATION. THE DETAIL KEYING, POLARIZATION AND LATCH WINDOW CONFIGURATION FOR EACH P/N, PLEASE SEE SHEET 2-5
RED	#-2232908-#	#-2232909-#	
BLUE	#-2232910-#	#-2232911-#	
YELLOW	#-2232912-#	#-2232913-#	
BLACK	#-2232914-#	#-2232915-#	
GREY	#-2232916-#	#-2232917-#	
GREEN	#-2232918-#	#-2232919-#	
PURPLE	#-2232920-#	#-2232921-#	
WHITE	#-2232922-#	#-2232923-#	

THIS DRAWING IS A CONTROLLED DOCUMENT.		OWN: WRP 21Jan2013	TE Connectivity NAME: RAST 5 TAB HEADER ASSY DIN STYLE, TH, VERTICAL
DIMENSIONS: mm		CHK: HAPYE WU 21Jan2013	
TOLERANCES UNLESS OTHERWISE SPECIFIED:		APVD: YHM 21Jan2013	
0 PLC ± 1 PLC ± 2 PLC ±0.25 3 PLC ± 4 PLC ± ANGLES ±2° FINISH		PRODUCT SPEC: 108-106080 APPLICATION SPEC: WEIGHT: - Customer Drawing	
MATERIAL: -	SCALE: -	SIZE: A1	CAGE CODE: 00779 DRAWING NO: 1971845 RESTRICTED TO: - SHEET 6 OF 6 REV: A15