

**PHASE CONTROL SCR
TO-220 FULLPAK**

Description/Features

The 25TTS..FP **SAFEIR** series of silicon controlled rectifiers are specifically designed for medium power switching and phase control applications. The glass passivation technology used has reliable operation up to 125° C junction temperature.

Typical applications are in input rectification (soft start) and these products are designed to be used with International Rectifier input diodes, switches and output rectifiers which are available in identical package outlines.

Fully isolated package ($V_{INS} = 2500 V_{RMS}$)

UL E78996 approved 

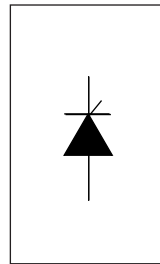

$V_T < 1.25V @ 16A$
 $I_{TSM} = 300A$
 $V_{RRM} 800 \text{ to } 1600V$

Output Current in Typical Applications

Applications	Single-phase Bridge	Three-phase Bridge	Units
Capacitive input filter $T_A = 55^\circ C, T_J = 125^\circ C$, common heatsink of $1^\circ C/W$	18	22	A

Major Ratings and Characteristics

Characteristics	25TTS..FP	Units
$I_{T(AV)}$ Sinusoidal waveform	16	A
I_{RMS}	25	A
V_{RRM}/V_{DRM}	upto 1600	V
I_{TSM}	300	A
$V_T @ 16A, T_J = 25^\circ C$	1.25	V
dv/dt	500	V/ μs
di/dt	150	A/ μs
T_J	-40 to 125	°C

Package Outline

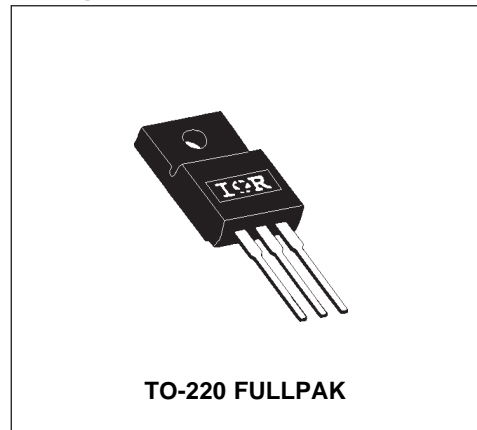

Voltage Ratings

Part Number	V_{RRM} , maximum peak reverse voltage V	V_{DRM} , maximum peak direct voltage V	I_{RRM}/I_{DRM} 125°C mA
25TTS08FP	800	800	10
25TTS12FP	1200	1200	
25TTS16FP	1600	1600	

Absolute Maximum Ratings

Parameters	25TTS..FP	Units	Conditions
$I_{T(AV)}$ Max. Average On-state Current	16	A	@ $T_c = 85^\circ\text{C}$, 180° conduction half sine wave
I_{RMS} Max. RMS On-state Current	25		
I_{TSM} Max. Peak One Cycle Non-Repetitive Surge Current	300 350		
I^2t Max. I^2t for fusing	450 630	A^2s	10ms Sine pulse, rated V_{RRM} applied 10ms Sine pulse, no voltage reapplied
$I^2\sqrt{t}$ Max. $I^2\sqrt{t}$ for fusing	6300		$A^2\sqrt{s}$
V_{TM} Max. On-state Voltage Drop	1.25	V	@ 16A, $T_j = 25^\circ\text{C}$
r_t On-state slope resistance	12.0	$m\Omega$	$T_j = 125^\circ\text{C}$
$V_{T(TO)}$ Threshold Voltage	1.0	V	
I_{RM}/I_{DM} Max. Reverse and Direct Leakage Current	0.5 10	mA	$T_j = 25^\circ\text{C}$ $T_j = 125^\circ\text{C}$ $V_R = \text{rated } V_{RRM} / V_{DRM}$
I_H Holding Current	Typ. Max. - 100 100 150		mA
I_L Max. Latching Current	200	Anode Supply = 6V, Resistive load	
dv/dt Max. Rate of Rise of off-state Voltage	500	$V/\mu s$	
di/dt Max. Rate of Rise of turned-on Current	150	$A/\mu s$	

Triggering

Parameters	25TTS..FP	Units	Conditions
P_{GM} Max. peak Gate Power	8.0	W	
$P_{G(AV)}$ Max. average Gate Power	2.0		
$+I_{GM}$ Max. peak positive Gate Current	1.5	A	
$-V_{GM}$ Max. peak negative Gate Voltage	10	V	
I_{GT} Max. required DC Gate Current to trigger	60	mA	Anode supply = 6V, resistive load, $T_J = -10^\circ\text{C}$
	45		Anode supply = 6V, resistive load, $T_J = 25^\circ\text{C}$
	20		Anode supply = 6V, resistive load, $T_J = 125^\circ\text{C}$
V_{GT} Max. required DC Gate Voltage to trigger	2.5	V	Anode supply = 6V, resistive load, $T_J = -10^\circ\text{C}$
	2.0		Anode supply = 6V, resistive load, $T_J = 25^\circ\text{C}$
	1.0		Anode supply = 6V, resistive load, $T_J = 125^\circ\text{C}$
V_{GD} Max. DC Gate Voltage not to trigger	0.25		$T_J = 125^\circ\text{C}$, $V_{DRM} = \text{rated value}$
I_{GD} Max. DC Gate Current not to trigger	2.0	mA	$T_J = 125^\circ\text{C}$, $V_{DRM} = \text{rated value}$

Switching

Parameters	25TTS..FP	Units	Conditions
t_{gt} Typical turn-on time	0.9	μs	$T_J = 25^\circ\text{C}$
t_{rr} Typical reverse recovery time	4		$T_J = 125^\circ\text{C}$
t_q Typical turn-off time	110		

Thermal-Mechanical Specifications

Parameters	25TTS..FP	Units	Conditions
T_J Max. Junction Temperature Range	-40 to 125	$^\circ\text{C}$	
T_{stg} Max. Storage Temperature Range	-40 to 125		
R_{thJC} Max. Thermal Resistance Junction to Case	1.5	$^\circ\text{C/W}$	DCoperation
R_{thJA} Max. Thermal Resistance Junction to Ambient	62		
R_{thCS} Typ. Thermal Resistance Case to Heatsink	1.5		Mounting surface, smooth and greased
wt Approximate Weight	2 (0.07)	g (oz.)	
T Mounting Torque	Min.	6 (5)	Kg-cm (lbf-in)
	Max.	12 (10)	
Case Style	TO-220FULLPAK		(94/V0)

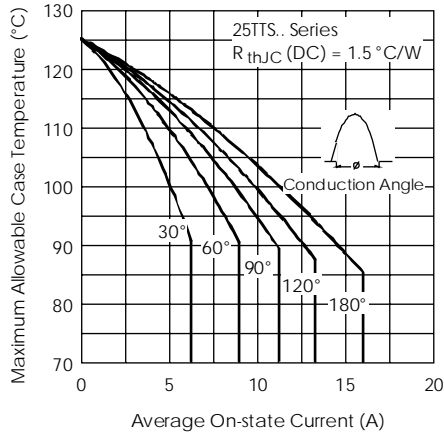

Fig. 1 - Current Rating Characteristics

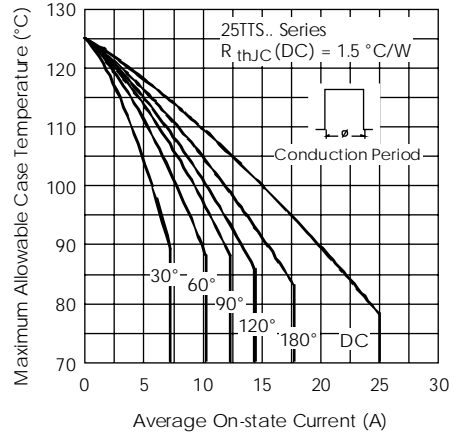

Fig. 2 - Current Rating Characteristics

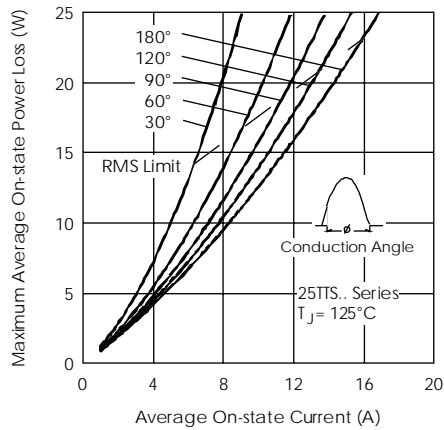

Fig. 3 - On-state Power Loss Characteristics

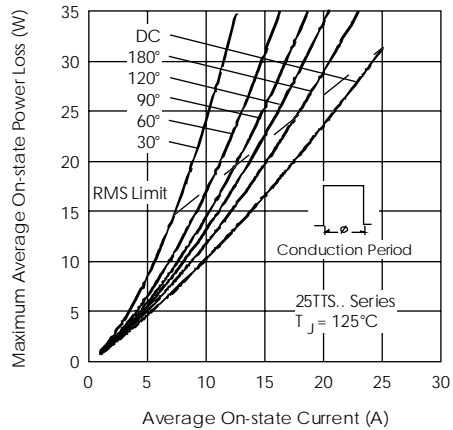

Fig. 4 - On-state Power Loss Characteristics

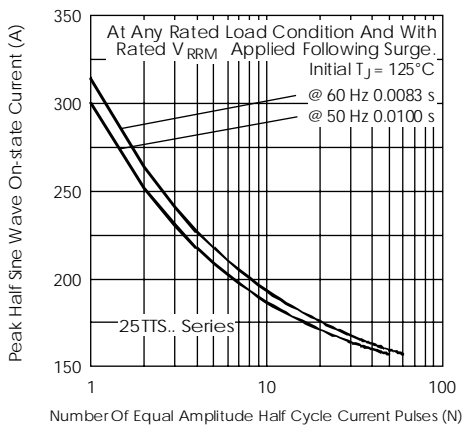

Fig. 5 - Maximum Non-Repetitive Surge Current

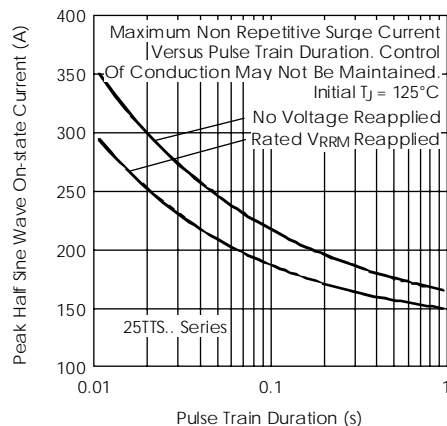

Fig. 6 - Maximum Non-Repetitive Surge Current

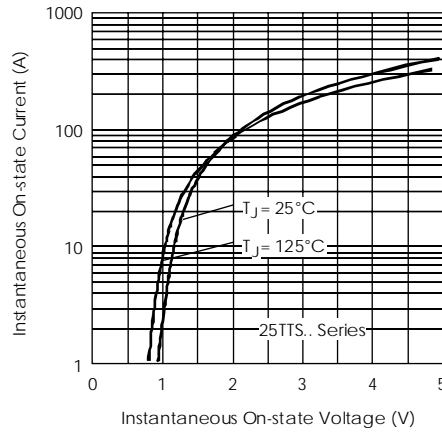

Fig. 7 - On-state Voltage Drop Characteristics

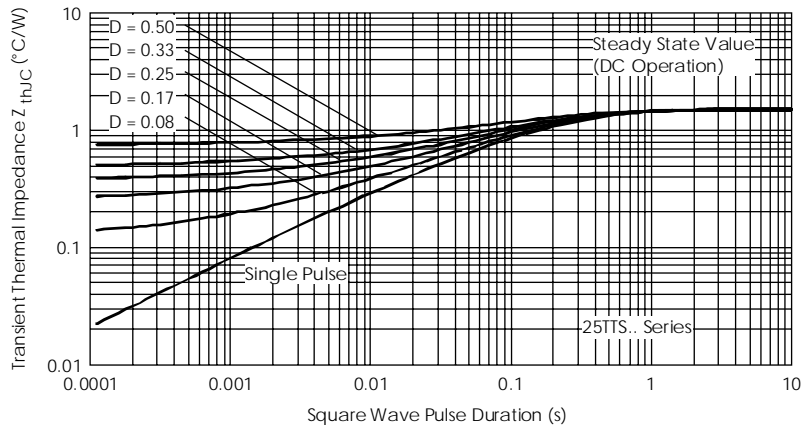

Fig. 8 - Thermal Impedance Z_{thJC} Characteristics

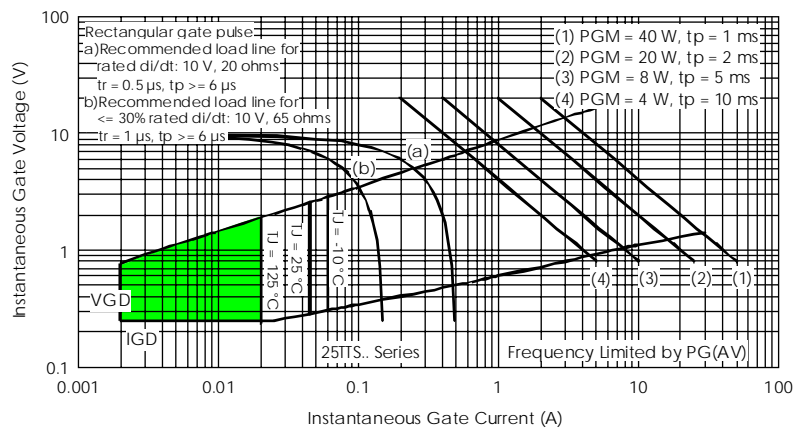

Fig. 9 - Gate Characteristics

25TTS..FP SAFEIR Series

Bulletin I2135 rev. D 03/99

International
IR Rectifier

Outline Table

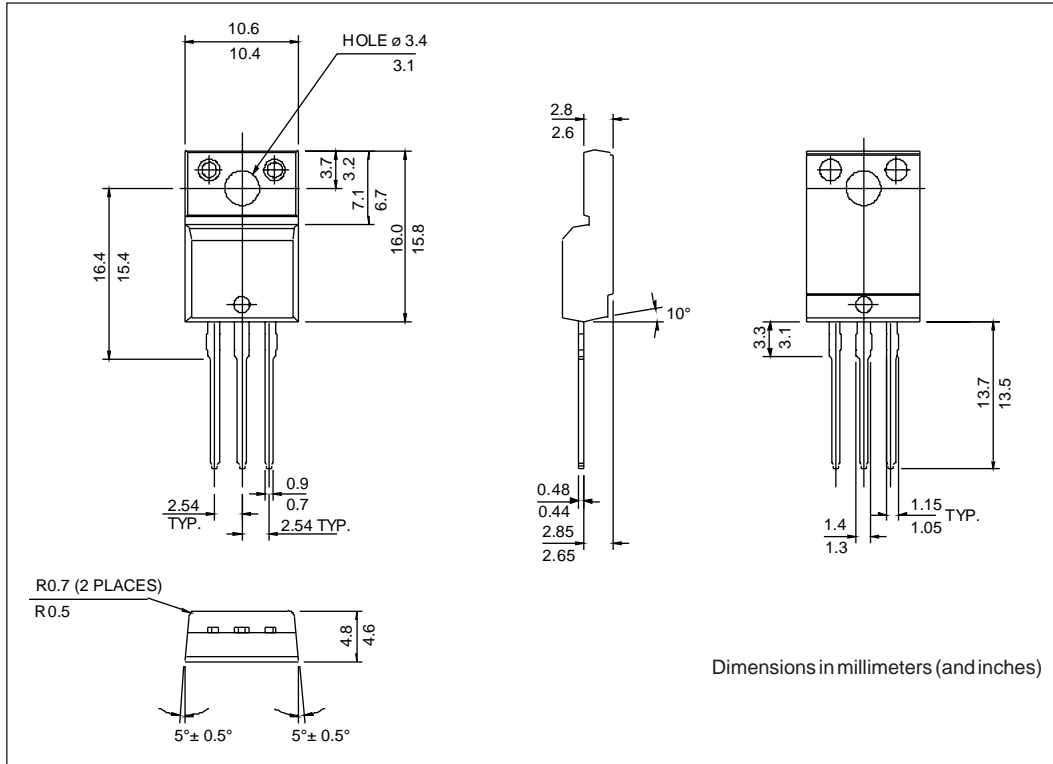

Ordering Information Table

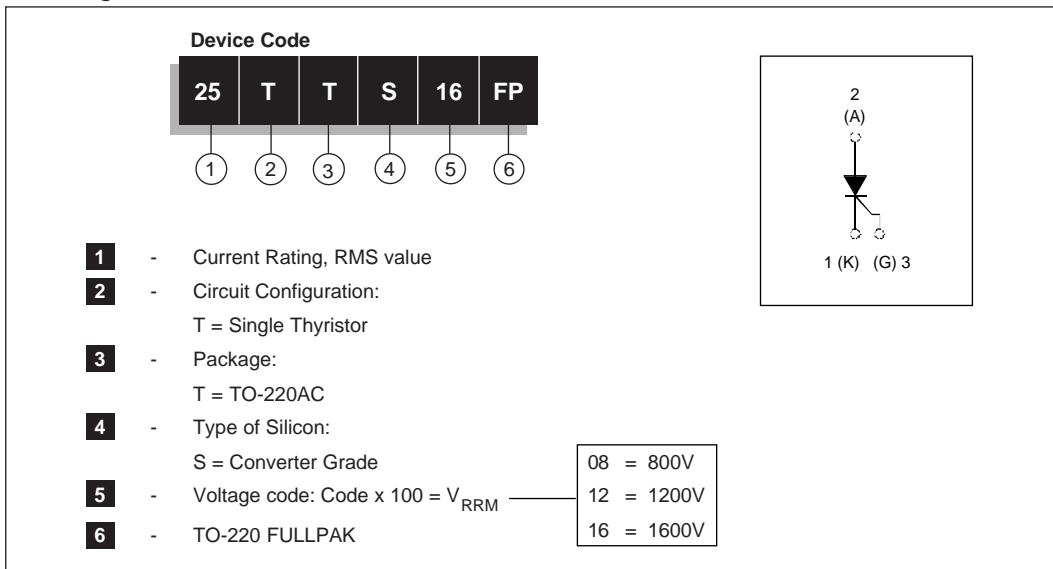

WORLDHEADQUARTERS: 233 Kansas St., El Segundo, California 90245 U.S.A. Tel: (310) 322 3331. Fax: (310) 322 3332.
EUROPEANHEADQUARTERS: Hurst Green, Oxted, Surrey RH8 9BB, U.K. Tel: ++ 44 1883 732020. Fax: ++ 44 1883 733408.
IR CANADA: 15 Lincoln Court, Brampton, Markham, Ontario L6T3Z2. Tel: (905) 453 2200. Fax: (905) 475 8801.
IR GERMANY: Saalburgstrasse 157, 61350 Bad Homburg. Tel: ++ 49 6172 96590. Fax: ++ 49 6172 965933.
IR ITALY: Via Liguria 49, 10071 Borgaro, Torino. Tel: ++ 39 11 4510111. Fax: ++ 39 11 4510220.
IR FAR EAST: K&H Bldg., 2F, 30-4 Nishi-Ikebukuro 3-Chome, Toshima-Ku, Tokyo, Japan 171. Tel: 81 3 3983 0086.
IR SOUTHEAST ASIA: 1 Kim Seng Promenade, Great World City West Tower,13-11, Singapore 237994. Tel: ++ 65 838 4630.
IR TAIWAN: 16 Fl. Suite D.207, Sec. 2, Tun Haw South Road, Taipei, 10673, Taiwan. Tel: 886 2 2377 9936.