

MM1Z2V0~MM1Z75

Silicon Planar Zener Diodes

Features

- Total power dissipation: max. 500 mW
- Small plastic package suitable for surface mounted design
- Tolerance approximately $\pm 5\%$

PINNING

PIN	DESCRIPTION
1	Cathode
2	Anode

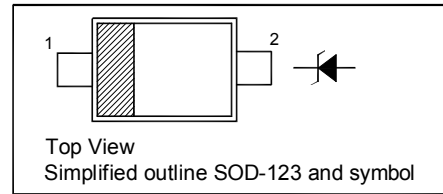

Absolute Maximum Ratings ($T_a = 25\text{ }^\circ\text{C}$)

Parameter	Symbol	Value	Unit
Power Dissipation $T_L = 75\text{ }^\circ\text{C}$ ¹⁾	P_{tot}	500	mW
Junction Temperature	T_j	150	$^\circ\text{C}$
Storage Temperature Range	T_{stg}	- 55 to + 150	$^\circ\text{C}$

Characteristics at $T_a = 25\text{ }^\circ\text{C}$

Parameter	Symbol	Max.	Unit
Thermal Resistance Junction to Ambient ²⁾	$R_{\theta JA}$	340	$^\circ\text{C/W}$
Thermal Resistance Junction to Lead ²⁾	$R_{\theta JL}$	150	$^\circ\text{C/W}$
Forward Voltage at $I_F = 10\text{ mA}$	V_F	0.9	V

¹⁾ FR-4 PCB = 89 * 38 mm.

²⁾ Mounted on an FR-4 PCB 38 * 38 * 1.6 mm with single-sided Cu pad areas 25mm²(>70 μm thick).

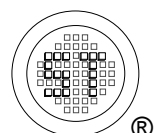

MM1Z2V0~MM1Z75

Characteristics at $T_a = 25\text{ }^\circ\text{C}$

Type	Marking Code	Zener Voltage Range ¹⁾			Dynamic Impedance ²⁾		Reverse Leakage Current	
		V_{znom}	V_{ZT}	at I_{ZT}	Z_{ZT}	at I_{ZT}	I_R	at V_R
		V	V	mA	Max. (Ω)	mA	Max. (μA)	V
MM1Z2V0	4A	2	1.8...2.15	5	100	5	120	0.5
MM1Z2V2	4B	2.2	2.08...2.33	5	100	5	120	0.7
MM1Z2V4	4C	2.4	2.28...2.56	5	100	5	120	1
MM1Z2V7	4D	2.7	2.5...2.9	5	110	5	120	1
MM1Z3V0	4E	3	2.8...3.2	5	120	5	50	1
MM1Z3V3	4F	3.3	3.1...3.5	5	130	5	20	1
MM1Z3V6	4H	3.6	3.4...3.8	5	130	5	10	1
MM1Z3V9	4J	3.9	3.7...4.1	5	130	5	5	1
MM1Z4V3	4K	4.3	4...4.6	5	130	5	5	1
MM1Z4V7	4M	4.7	4.4...5	5	130	5	2	1
MM1Z5V1	4N	5.1	4.8...5.4	5	130	5	2	1.5
MM1Z5V6	4P	5.6	5.2...6	5	80	5	1	2.5
MM1Z6V2	4R	6.2	5.8...6.6	5	50	5	1	3
MM1Z6V8	4X	6.8	6.4...7.2	5	30	5	0.5	3.5
MM1Z7V5	4Y	7.5	7...7.9	5	30	5	0.5	4
MM1Z8V2	4Z	8.2	7.7...8.7	5	30	5	0.5	5
MM1Z9V1	5A	9.1	8.5...9.6	5	30	5	0.5	6
MM1Z10	5B	10	9.4...10.6	5	30	5	0.1	7
MM1Z11	5C	11	10.4...11.6	5	30	5	0.1	8
MM1Z12	5D	12	11.4...12.7	5	35	5	0.1	9
MM1Z13	5E	13	12.4...14.1	5	35	5	0.1	10
MM1Z15	5F	15	13.8...15.6	5	40	5	0.1	11
MM1Z16	5H	16	15.3...17.1	5	40	5	0.1	12
MM1Z18	5J	18	16.8...19.1	5	45	5	0.1	13
MM1Z20	5K	20	18.8...21.2	5	50	5	0.1	15
MM1Z22	5M	22	20.8...23.3	5	55	5	0.1	17
MM1Z24	5N	24	22.8...25.6	5	60	5	0.1	19
MM1Z27	5P	27	25.1...28.9	5	70	2	0.1	21
MM1Z30	5R	30	28...32	5	80	2	0.1	23
MM1Z33	5X	33	31...35	5	80	2	0.1	25
MM1Z36	5Y	36	34...38	5	90	2	0.1	27
MM1Z39	5Z	39	37...41	2.5	100	2	2	30
MM1Z43	6A	43	40...46	2.5	130	2	2	33
MM1Z47	6B	47	44...50	2.5	150	2	2	36
MM1Z51	6C	51	48...54	2.5	180	2	1	39
MM1Z56	6D	56	52...60	2.5	180	2	1	43
MM1Z62	6E	62	58...66	2.5	200	2	0.2	47
MM1Z68	6F	68	64...72	2.5	250	2	0.2	52
MM1Z75	6H	75	70...79	2.5	300	2	0.2	57

¹⁾ V_Z is tested with pulses (20 ms).

²⁾ Z_{ZT} is measured at I_Z by given a very small A.C. current signal.

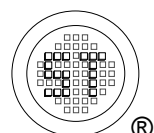

MM1Z2V0~MM1Z75

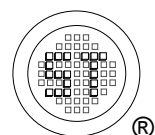
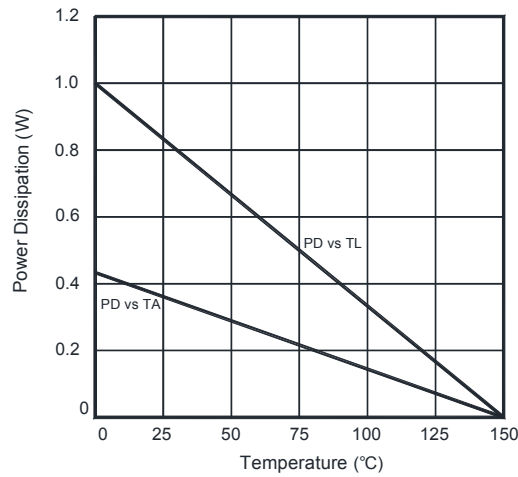
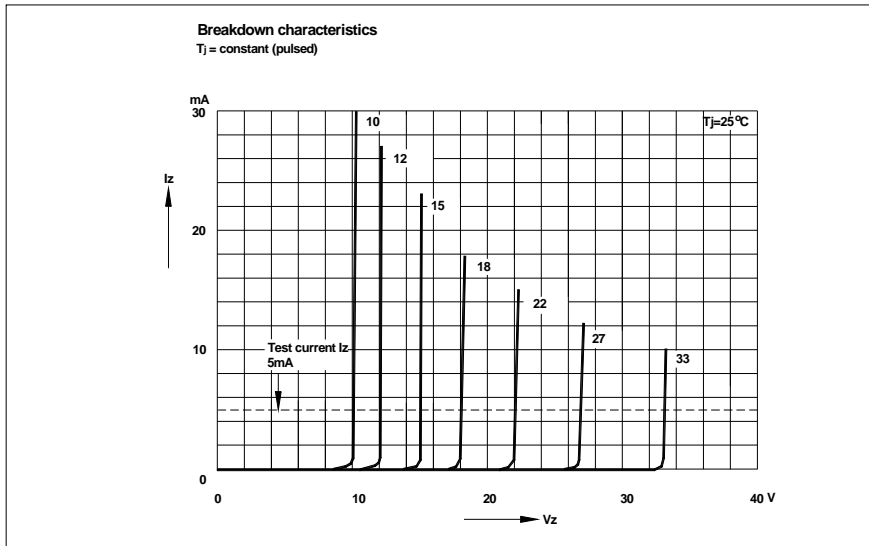
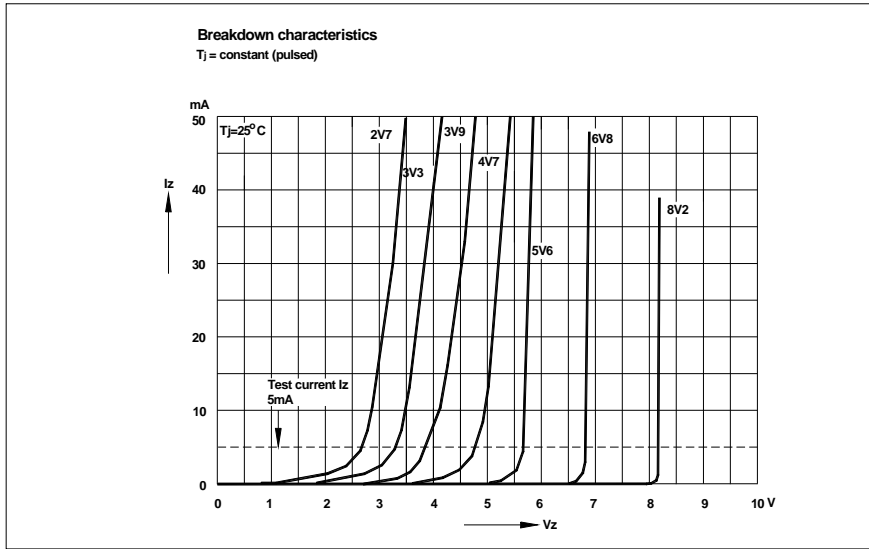

MM1Z2V0~MM1Z75

PACKAGE OUTLINE

Plastic surface mounted package; 2 leads

SOD-123

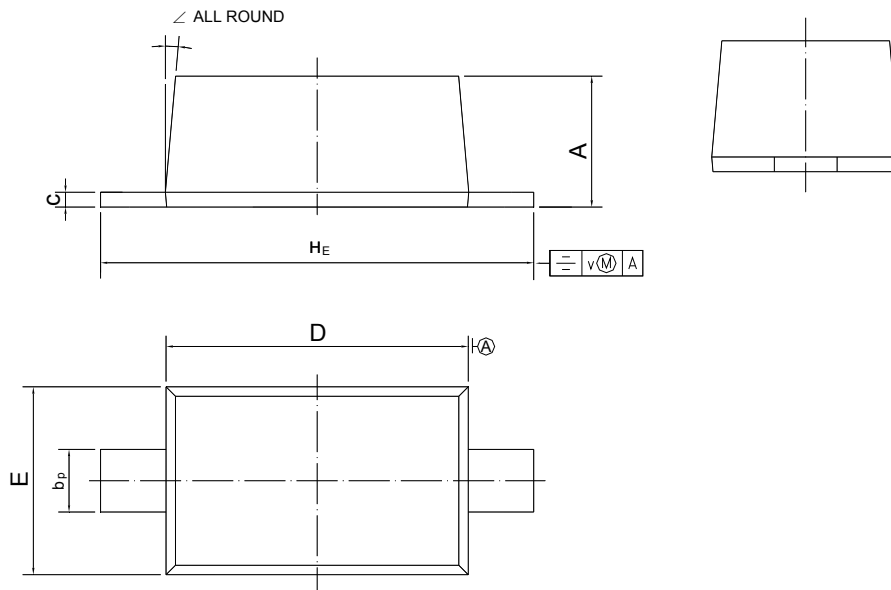

UNIT	A	b _p	c	D	E	H _E	v	∠
mm	1.15 1.05	0.6 0.5	0.135 0.100	2.7 2.6	1.65 1.55	3.85 3.55	0.2	5°

Recommended Soldering Footprint

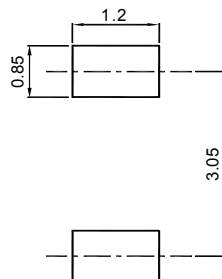

Packing information

Package	Tape Width (mm)	Pitch		Reel Size		Per Reel Packing Quantity
		mm	(inch)	mm	(inch)	
SOD-123	8	4 ± 0.1	0.157 ± 0.004	178	7	3,000

Marking information

"****" = Part No

"III" = Cathode line

Font type: Arial

