

TPS751xxQ with Power Good Output, TPS753xxQ with $\overline{\text{RESET}}$ Output FAST-TRANSIENT-RESPONSE 1.5-A LOW-DROPOUT VOLTAGE REGULATORS

FEATURES

- 1.5-A Low-Dropout Voltage Regulator
- Available in 1.5 V, 1.8 V, 2.5 V, and 3.3 V Fixed Output and Adjustable Versions
- Open Drain Power-Good (PG) Status Output (TPS751xxQ)
- Open Drain Power-On Reset With 100ms Delay (TPS753xxQ)
- Dropout Voltage Typically 160 mV at 1.5 A (TPS75133Q)
- Ultralow 75- μA Typical Quiescent Current
- Fast Transient Response
- 2% Tolerance Over Specified Conditions for Fixed-Output Versions
- 20-Pin TSSOP PowerPAD™ (PWP) Package
- Thermal Shutdown Protection

APPLICATIONS

- Telecom
- Servers
- DSP, FPGA Supplies

DESCRIPTION

The TPS753xxQ and TPS751xxQ devices are low-dropout regulators with integrated power-on reset and power-good (PG) functions respectively. These devices are capable of supplying 1.5 A of output current with a dropout of 160 mV (TPS75133Q, TPS75333Q). Quiescent current is 75 μA at full load and drops down to 1 μA when the device is disabled. These devices are designed to have fast transient response for larger load current changes.

Because the PMOS device behaves as a low-value resistor, the dropout voltage is very low (typically 160 mV at an output current of 1.5 A for the TPS75x33Q) and is directly proportional to the output current. Additionally, because the PMOS pass element is a voltage-driven device, the quiescent current is very low and independent of output loading (typically 75 μA over the full range of output current, 1 mA to 1.5 A). These two key specifications yield a significant improvement in operating life for battery-powered systems.

The device is enabled when $\overline{\text{EN}}$ is connected to a low-level input voltage. This LDO family also features a sleep mode; applying a TTL high signal to $\overline{\text{EN}}$ (enable) shuts down the regulator, reducing the quiescent current to less than 1 μA at $T_J = +25^\circ\text{C}$.

**Typical Application Circuit
(Fixed Voltage Options)**

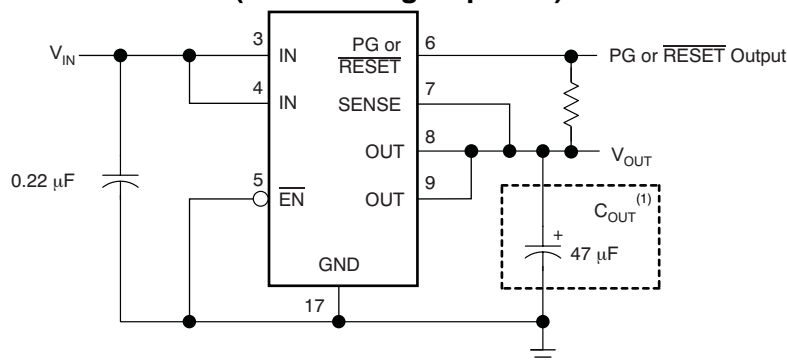

(1) See [Application Information](#) for capacitor selection details.



Please be aware that an important notice concerning availability, standard warranty, and use in critical applications of Texas Instruments semiconductor products and disclaimers thereto appears at the end of this data sheet.

PowerPAD is a trademark of Texas Instruments.
All other trademarks are the property of their respective owners.

DESCRIPTION, CONTINUED

For the TPS751xxQ, the power-good terminal (PG) is an active high, open drain output for use with a power-on reset or a low-battery indicator.

The $\overline{\text{RESET}}$ (SVS, POR, or power on reset) output of the TPS753xxQ initiates a reset in microcomputer and microprocessor systems in the event of an undervoltage condition. An internal comparator in the TPS753xxQ monitors the output voltage of the regulator to detect an undervoltage condition on the regulated output voltage. When the output reaches 95% of its regulated voltage, $\overline{\text{RESET}}$ goes to a high-impedance state after a 100-ms delay. $\overline{\text{RESET}}$ goes to a logic-low state when the regulated output voltage is pulled below 95% (that is, during an overload condition) of its regulated voltage.

The TPS751xxQ and TPS753xxQ are offered in 1.5 V, 1.8 V, 2.5 V and 3.3 V fixed-voltage versions and in an adjustable version (programmable over the range of 1.5 V to 5 V). Output voltage tolerance is specified as a maximum of 2% over line, load, and temperature ranges. The TPS751xxQ and TPS753xxQ families are available in a 20-pin TSSOP (PWP) package.



This integrated circuit can be damaged by ESD. Texas Instruments recommends that all integrated circuits be handled with appropriate precautions. Failure to observe proper handling and installation procedures can cause damage.

ESD damage can range from subtle performance degradation to complete device failure. Precision integrated circuits may be more susceptible to damage because very small parametric changes could cause the device not to meet its published specifications.

ORDERING INFORMATION⁽¹⁾

PRODUCT	V _{OUT} ⁽²⁾
TPS751xxyyyz, TPS753xxyyyz	XX is nominal output voltage (for example, 15 = 1.5 V, 01 = Adjustable ⁽³⁾). YYY is package designator. Z is package quantity.

- (1) For the most current package and ordering information see the Package Option Addendum at the end of this document, or see the TI website at www.ti.com.
- (2) Custom fixed output voltages are available; minimum order quantities may apply. Contact factory for details and availability.
- (3) The TPS75x01 is programmable using an external resistor divider (see [Application Information](#)).

ABSOLUTE MAXIMUM RATINGS⁽¹⁾

Over operating temperature range (unless otherwise noted).

PARAMETER	TPS751xxQ, TPS753xxQ	UNIT
Input voltage range, V _{IN} ⁽²⁾	–0.3 to +6	V
Voltage range at $\overline{\text{EN}}$	–0.3 to +16.5	V
Maximum PG voltage (TPS751xxQ)	16.5	V
Maximum $\overline{\text{RESET}}$ voltage (TPS753xxQ)	16.5	V
Peak output current	Internally limited	
Continuous total power dissipation	See Dissipation Ratings Table	
Output voltage range at OUT, FB	5.5	V
Operating virtual junction temperature range, T _J	–40 to +125	°C
Storage junction temperature range, T _{STG}	–65 to +150	°C
ESD rating, HBM	2	kV

- (1) Stresses above these ratings may cause permanent damage to the device. Exposure to absolute maximum conditions for extended periods may degrade device reliability. These are stress ratings only, and functional operation of the device at these or any other conditions beyond those specified is not implied.
- (2) All voltages are with respect to network terminal ground.

DISSIPATION RATINGS

BOARD	PACKAGE	AIRFLOW (CFM)	$T_A < +25^\circ\text{C}$	DERATING FACTOR ABOVE $T_A = +25^\circ\text{C}$	$T_A = +70^\circ\text{C}$	$T_A = +85^\circ\text{C}$
Low-K ⁽¹⁾	PWP	0	2.9 mW	23.5 mW/°C	1.9 W	1.5 W
		300	4.3 mW	34.6 mW/°C	2.8 W	2.2 W
High-K ⁽²⁾	PWP	0	3 W	23.8 mW/°C	1.9 W	1.5 W
		300	7.2 W	57.9 mW/°C	4.6 W	3.8 W

- (1) This parameter is measured with the recommended copper heat sink pattern on a 1-layer, 5-in \times 5-in printed circuit board (PCB), 1-ounce copper, 2-in \times 2-in coverage (4 in²).
- (2) This parameter is measured with the recommended copper heat sink pattern on a 8-layer, 1.5-in \times 2-in PCB, 1-ounce copper with layers 1, 2, 4, 5, 7, and 8 at 5% coverage (0.9 in²) and layers 3 and 6 at 100% coverage (6 in²). For more information, refer to TI technical brief [SLMA002](#).

RECOMMENDED OPERATING CONDITIONS

		MIN	MAX	MAX
V_{IN}	Input voltage range ⁽¹⁾	2.7	5.5	V
V_{OUT}	Output voltage range	1.5	5	V
I_{OUT}	Output current	0	2.0	A
T_J	Operating virtual junction temperature	-40	+125	°C

- (1) To calculate the minimum input voltage for your maximum output current, use the following equation: $V_{IN(min)} = V_{OUT(max)} + V_{DO(max\ load)}$.

ELECTRICAL CHARACTERISTICS

Over recommended operating temperature range ($T_J = -40^\circ\text{C}$ to $+125^\circ\text{C}$), $V_{IN} = V_{OUT(TYP)} + 1\text{ V}$; $I_{OUT} = 1\text{ mA}$, $V_{EN} = 0\text{ V}$, $C_{OUT} = 47\text{ }\mu\text{F}$, unless otherwise noted. Typical values are at $T_J = +25^\circ\text{C}$.

PARAMETER		TEST CONDITIONS	TPS751xxQ, TPS753xxQ			UNIT
			MIN	TYP	MAX	
$V_{OUT}^{(1)}$	Adjustable output	$1.5\text{ V} \leq V_{OUT} \leq 5.5\text{ V}$	$0.98V_{OUT}$		$1.02V_{OUT}$	V
	1.5 V output	$2.7\text{ V} < V_{IN} < 5.5\text{ V}$	1.470	1.5	1.530	
	1.8 V output	$2.8\text{ V} < V_{IN} < 5.5\text{ V}$	1.764	1.8	1.836	
	2.5 V output	$3.5\text{ V} < V_{IN} < 5.5\text{ V}$	2.450	2.5	2.550	
	3.3 V output	$4.3\text{ V} < V_{IN} < 5.5\text{ V}$	3.234	3.3	3.336	
$I_{GND}^{(2)}$	Ground pin current	$I_{OUT} = 1\text{ mA}$ to 1.5 A		75	125	μA
$\frac{\Delta V_{OUT}}{V_{OUT}}\%$ $\frac{\Delta V_{OUT}^{(1),(2)}}{V_{OUT}}$	Output voltage line regulation	$V_{OUT} + 1\text{ V} < V_{IN} \leq 5\text{ V}$		0.01	0.1	%/V
$\frac{\Delta V_{OUT}}{\Delta I_{OUT}}$	Load regulation	$I_{OUT} = 1\text{ mA}$ to 1.5 A		1		mV
V_N	Output noise voltage BW = 300 Hz to 50 kHz	$V_{OUT} = 1.5\text{ V}$, $C_{OUT} = 100\text{ }\mu\text{F}$		60		μV_{RMS}
V_{DO}	Dropout voltage ⁽³⁾	TPS75133Q	$I_{OUT} = 1.5\text{ A}$, $V_{IN} = 3.2\text{ V}$	160	300	mV
		TPS75333Q				
I_{CL}	Output current limit	$V_{OUT} = 0\text{ V}$		3.3	4.5	A
T_{SD}	Shutdown temperature			+150		$^\circ\text{C}$
I_{STBY}	Standby current	$\overline{EN} = V_{IN}$		1	10	μA
I_{FB}	FB input current	TPS75x01Q $FB = 1.5\text{ V}$	-1		1	μA
$V_{EN(HI)}$	High-level enable input voltage		2			V
$V_{EN(LO)}$	Low-level enable input voltage				0.7	V
PSRR	Power-supply ripple rejection ⁽²⁾	$f = 100\text{ Hz}$, $C_{OUT} = 100\text{ }\mu\text{F}$, $I_{OUT} = 1.5\text{ A}$, See ⁽¹⁾		63		dB
PG (TPS751xxQ)	Minimum input voltage for valid PG	$I_{OUT(PG)} = 300\text{ }\mu\text{A}$		1	1.3	V
	Trip threshold voltage	V_{OUT} decreasing	80		86	% V_{OUT}
	Hysteresis voltage	Measured at V_{OUT}		0.5		% V_{OUT}
	Output low voltage	$V_{IN} = 2.7\text{ V}$, $I_{OUT(PG)} = 1\text{ mA}$		0.15	0.4	V
	Leakage current	$V_{(PG)} = 5.5\text{ V}$			1	μA
RESET (TPS753xxQ)	Minimum input voltage for valid RESET	$I_{OUT(RESET)} = 300\text{ }\mu\text{A}$, $V_{(RESET)} \leq 0.8\text{ V}$		1.1	1.3	V
	Trip threshold voltage	V_{OUT} decreasing	92		98	% V_{OUT}
	Hysteresis voltage	Measured at V_{OUT}		0.5		% V_{OUT}
	Output low voltage	$I_{OUT(RESET)} = 1\text{ mA}$		0.15	0.4	V
	Leakage current	$V_{(RESET)} = 5.5\text{ V}$			1	μA
	RESET timeout delay			100		ms
Input current (\overline{EN})		$\overline{EN} = 0\text{ V}$	-1	0	1	μA
		$\overline{EN} = V_{IN}$	-1		1	

(1) Minimum $V_{IN} = (V_{OUT} + 1\text{ V})$ or 2.7 V, whichever is greater. Maximum $V_{IN} = 5.5\text{ V}$.

(2) If $V_{OUT} \leq 1.8\text{ V}$, then $V_{IN(min)} = 2.7\text{ V}$, $V_{IN(max)} = 5.5\text{ V}$:

$$\text{Line Regulation (mV)} = (\%/V) \times \frac{V_{OUT}(V_{IN(Max)} - 2.7V)}{100} \times 1000$$

If $V_{OUT} \geq 2.5\text{ V}$, then $V_{IN(min)} = V_{OUT} + 1\text{ V}$, $V_{IN(max)} = 5.5\text{ V}$:

$$\text{Line Regulation (mV)} = (\%/V) \times \frac{V_{OUT}[V_{IN(Max)} - (V_{OUT} + 1V)]}{100} \times 1000$$

(3) Input voltage equals $V_{OUT(TYP)} - 100\text{ mV}$; TPS75x33Q input voltage must drop to 3.2 V for this test.

FUNCTIONAL BLOCK DIAGRAMS

Adjustable Voltage Versions

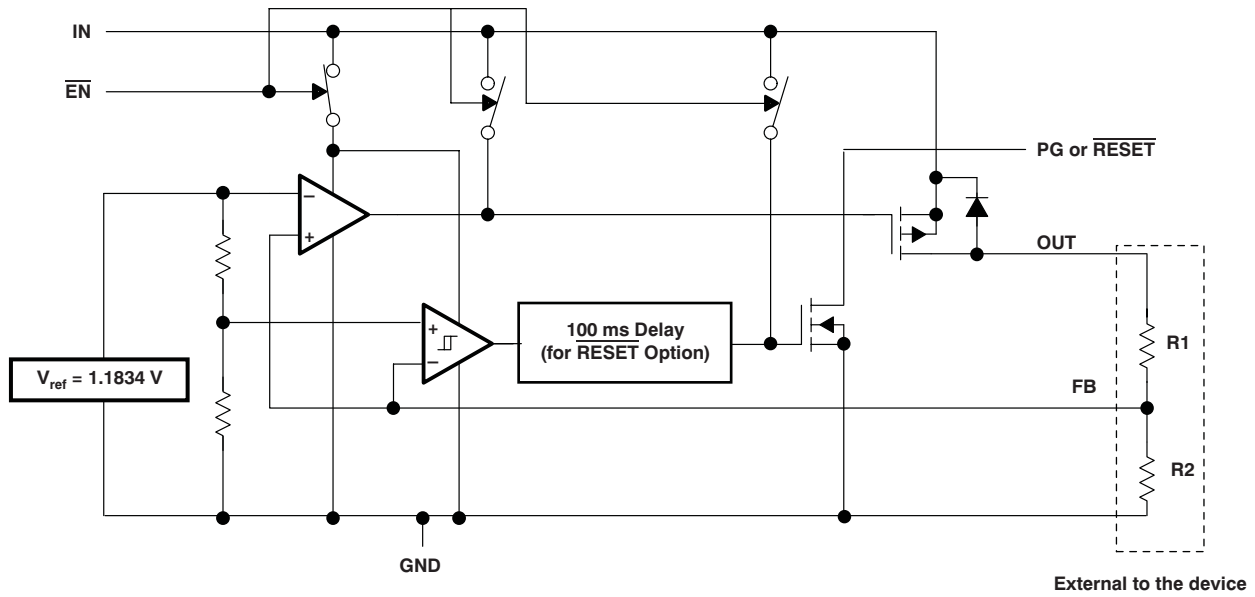

Fixed-Voltage Versions

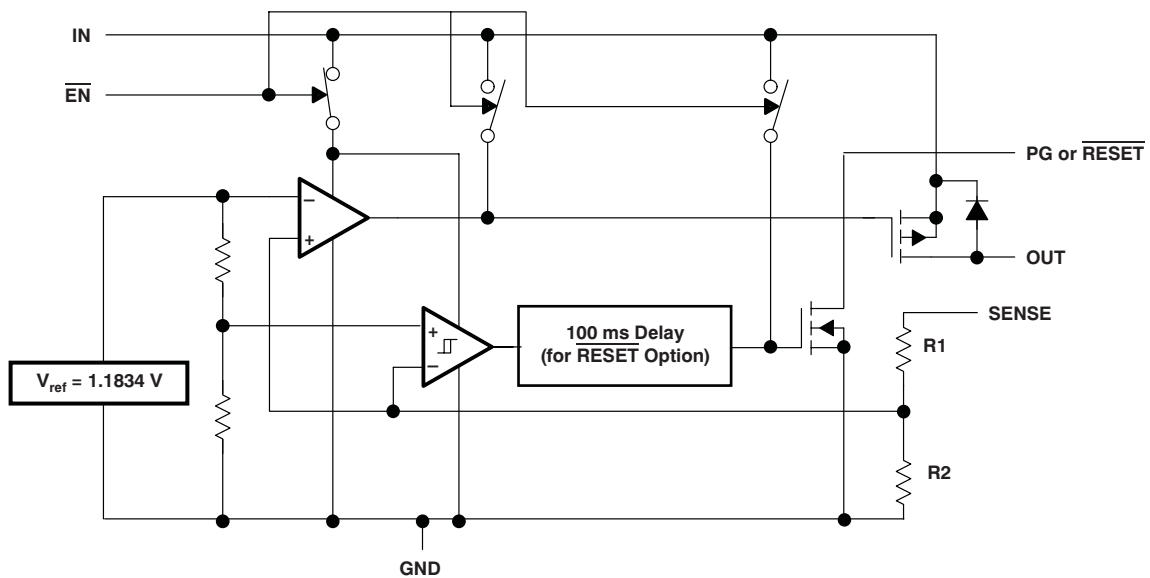

PIN CONFIGURATIONS

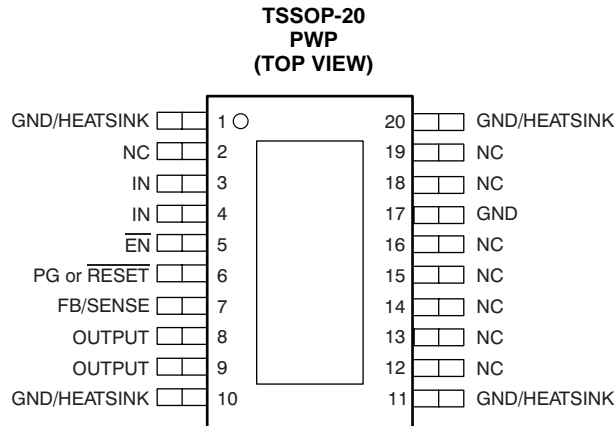
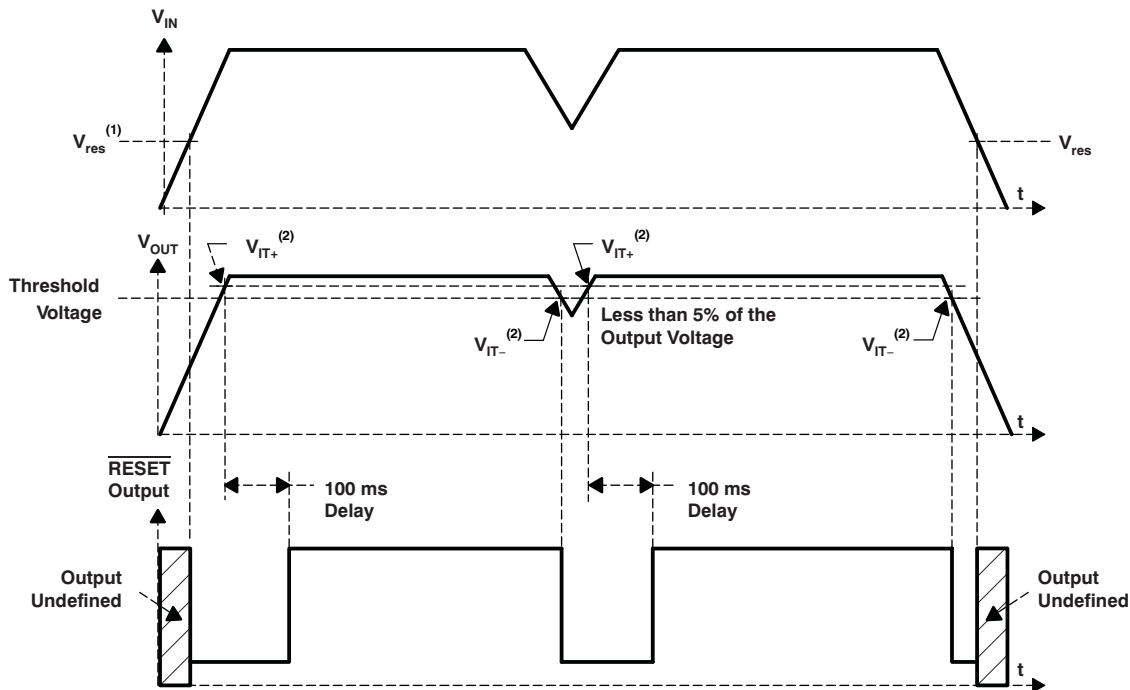

Table 1. PIN DESCRIPTIONS

TPS751xxQ, TPS753xxQ		I/O	DESCRIPTION
NAME	TSSOP-20 (PWP) PIN NO.		
$\overline{\text{EN}}$	5	I	Negative polarity enable ($\overline{\text{EN}}$) input
FB/SENSE	7	I	Adjustable voltage version only; feedback voltage for setting output voltage of the device. Not internally connected on adjustable versions. Sense input for fixed options.
GND	17		Ground
GND/HEATSINK	1, 10, 11, 20		Ground/heatsink
IN	3, 4	I	Input voltage
NC	2, 12, 13, 14, 15, 16, 18, 19		Not connected
OUTPUT	8, 9	O	Regulated output voltage
PG/ $\overline{\text{RESET}}$	6	O	TPS751xxQ devices only; open-drain power-good (PG) output. TPS753xxQ devices only; open-drain $\overline{\text{RESET}}$ output.

TPS753xxQ RESET Timing Diagram



- (1) V_{res} is the minimum input voltage for a valid \overline{RESET} . The symbol V_{res} is not currently listed within EIA or JEDEC standards for semiconductor symbology.
- (2) V_{IT-} : Trip voltage is typically 5% lower than the output voltage ($95\% V_{OUT}$). V_{IT-} to V_{IT+} is the hysteresis voltage.

TPS751xxQ Power Good Timing Diagram

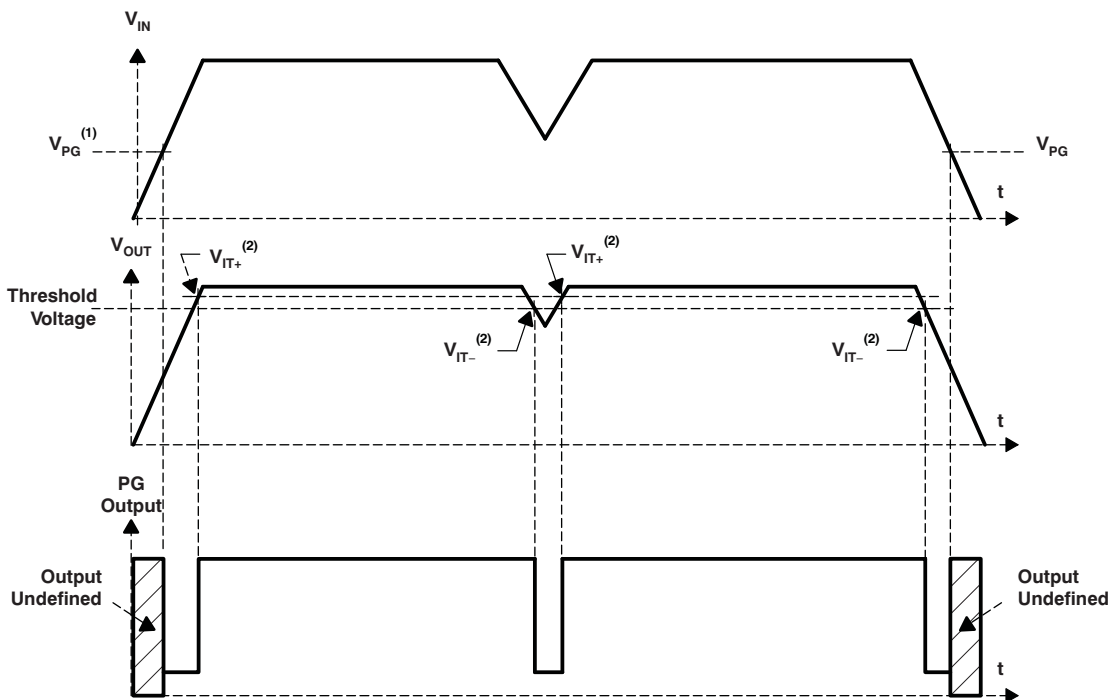

- (1) V_{PG} is the minimum input voltage for a valid Power Good. The symbol V_{PG} is not currently listed within EIA or JEDEC standards for semiconductor symbology.
- (2) V_{IT-} : Trip voltage is typically 17% lower than the output voltage ($83\% V_{OUT}$). V_{IT-} to V_{IT+} is the hysteresis voltage.

TYPICAL CHARACTERISTICS

Table of Graphs

			FIGURE NO.
V_{OUT}	Output Voltage	vs Output Current	Figure 3, Figure 4
		vs Junction Temperature	Figure 5, Figure 6
		vs Time	Figure 18
I_{GND}	Ground Current	vs Junction Temperature	Figure 7
PSRR	Power-Supply Ripple Rejection	vs Frequency	Figure 8
	Output Spectral Noise Density	vs Frequency	Figure 9
Z_{OUT}	Output Impedance	vs Frequency	Figure 10
V_{DO}	Dropout Voltage	vs Input Voltage	Figure 11
		vs Junction Temperature	Figure 12
V_{IN}	Input Voltage (Min)	vs Output Voltage	Figure 13
LINE	Line Transient Response		Figure 14, Figure 16
LOAD	Load Transient Response		Figure 15, Figure 17
ESR	Equivalent Series Resistance	vs Output Current	Figure 20, Figure 21

TYPICAL CHARACTERISTICS

Over operating temperature range ($T_J = -40^\circ\text{C}$ to $+125^\circ\text{C}$) unless otherwise noted. Typical values are at $T_J = +25^\circ\text{C}$.

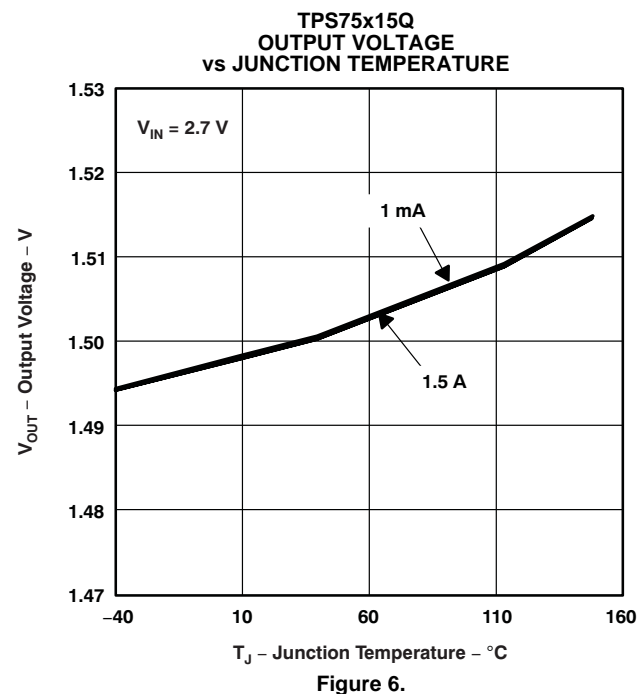
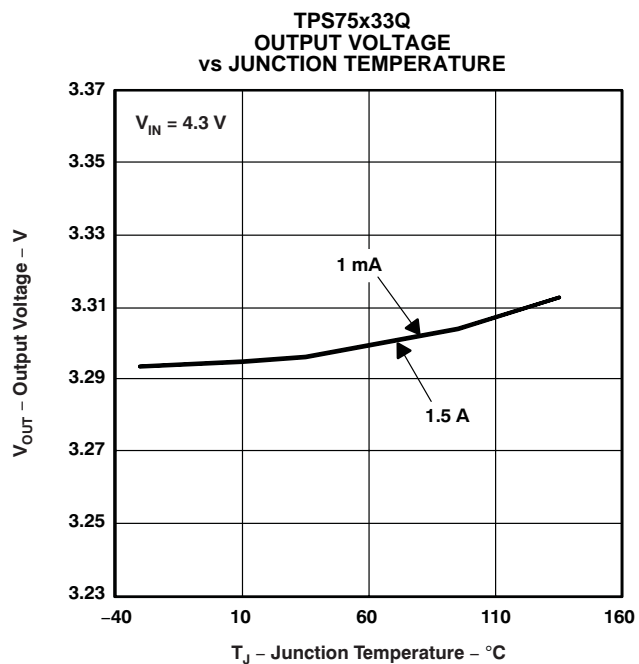
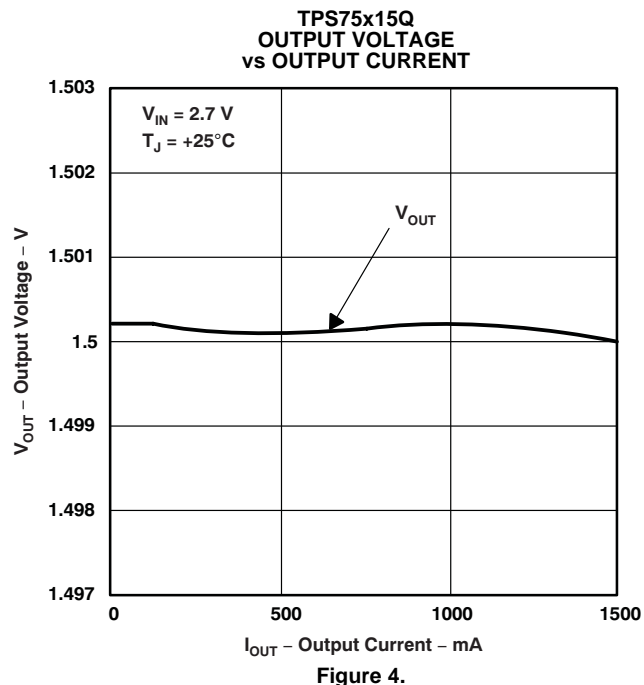
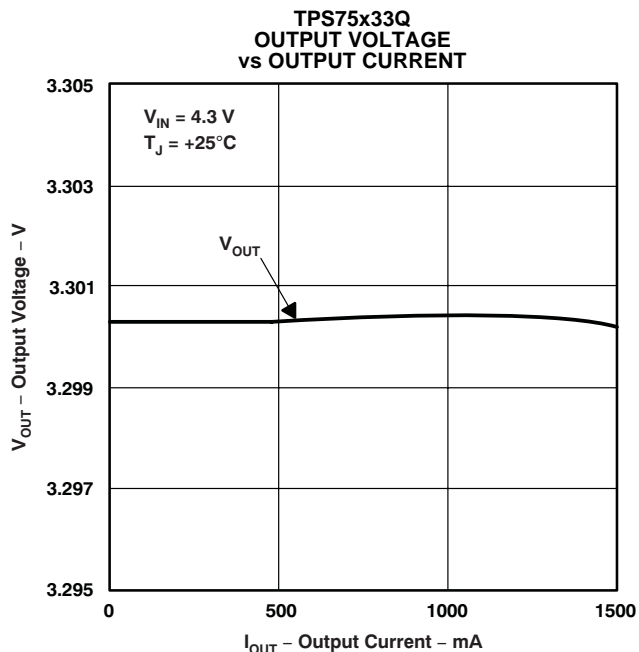

TYPICAL CHARACTERISTICS (continued)

Over operating temperature range ($T_J = -40^\circ\text{C}$ to $+125^\circ\text{C}$) unless otherwise noted. Typical values are at $T_J = +25^\circ\text{C}$.

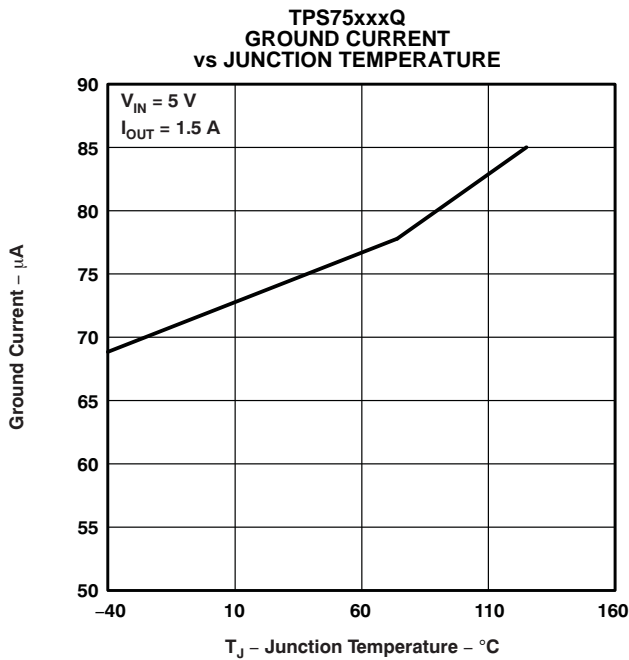

Figure 7.

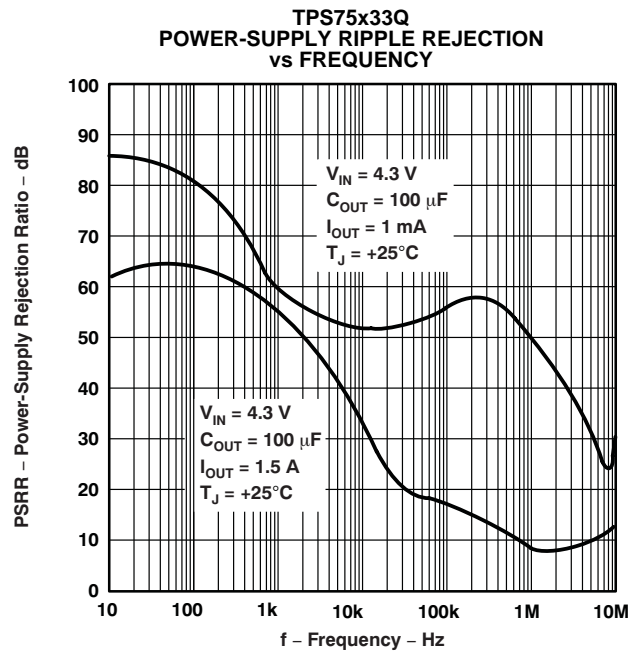

Figure 8.

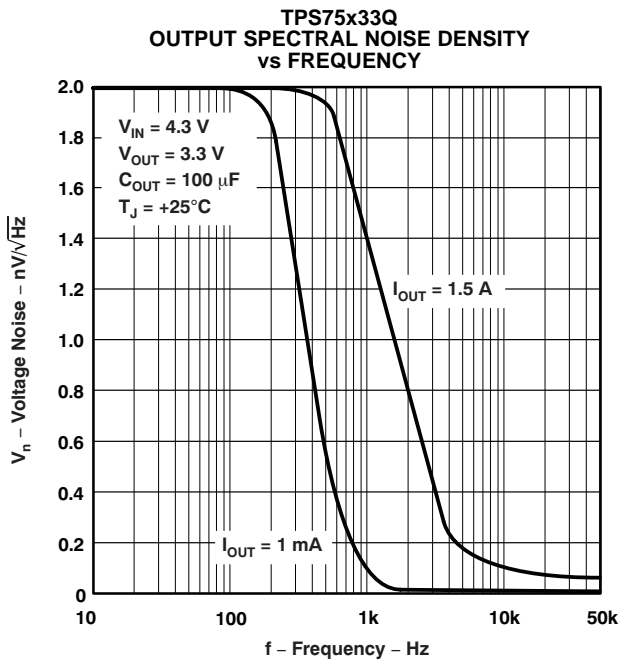

Figure 9.

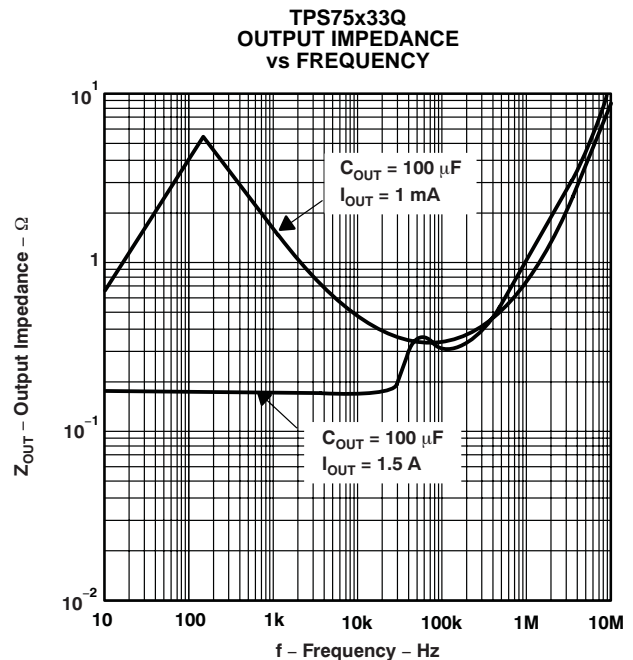

Figure 10.

TYPICAL CHARACTERISTICS (continued)

Over operating temperature range ($T_J = -40^\circ\text{C}$ to $+125^\circ\text{C}$) unless otherwise noted. Typical values are at $T_J = +25^\circ\text{C}$.

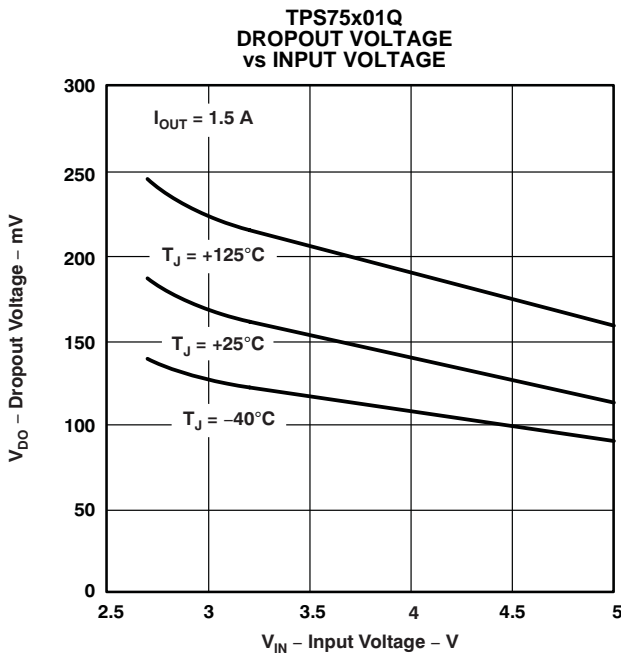

Figure 11.

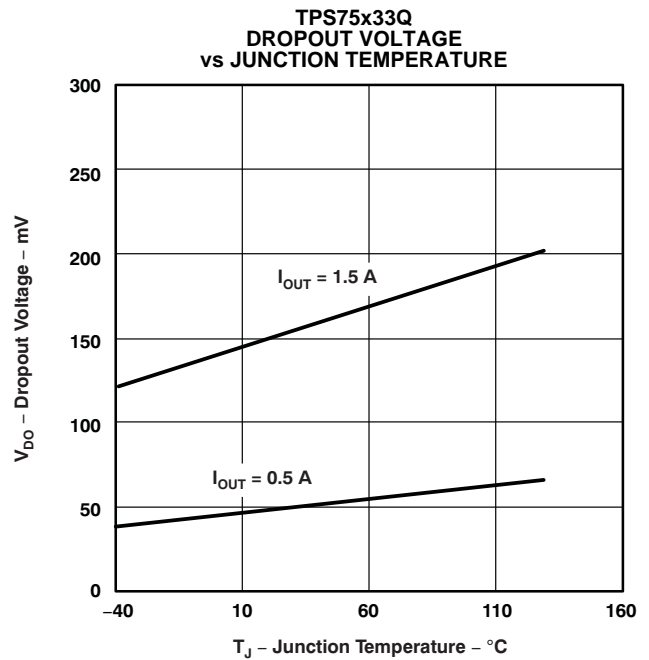

Figure 12.

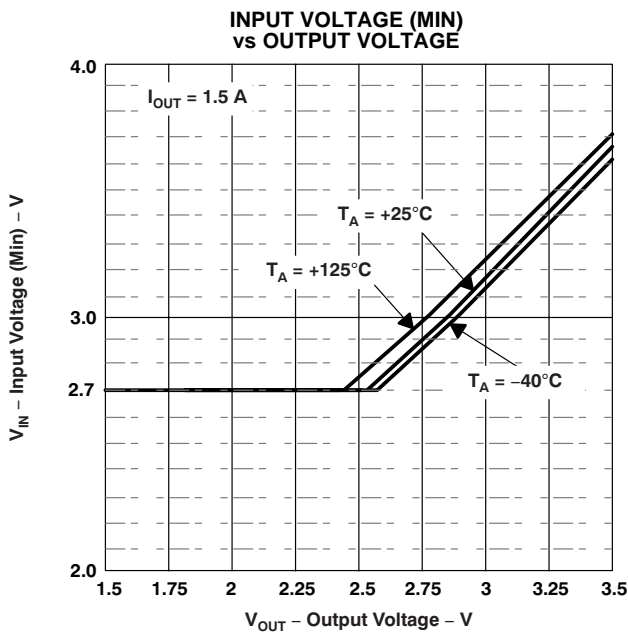

Figure 13.

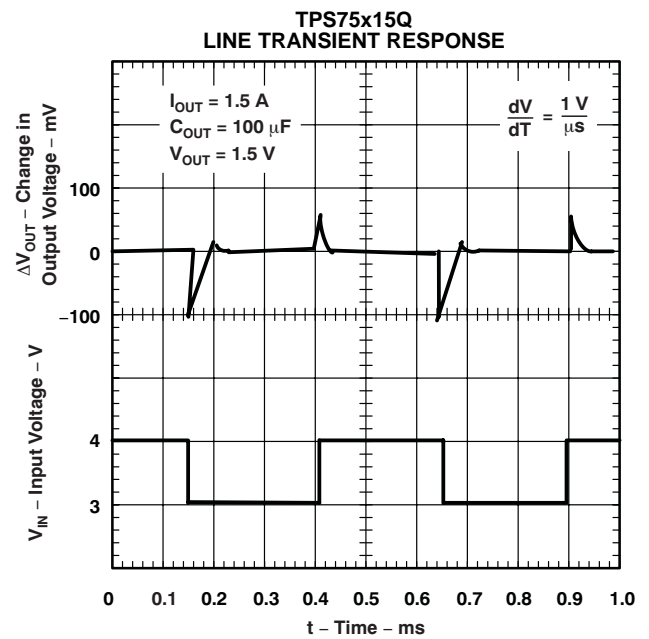
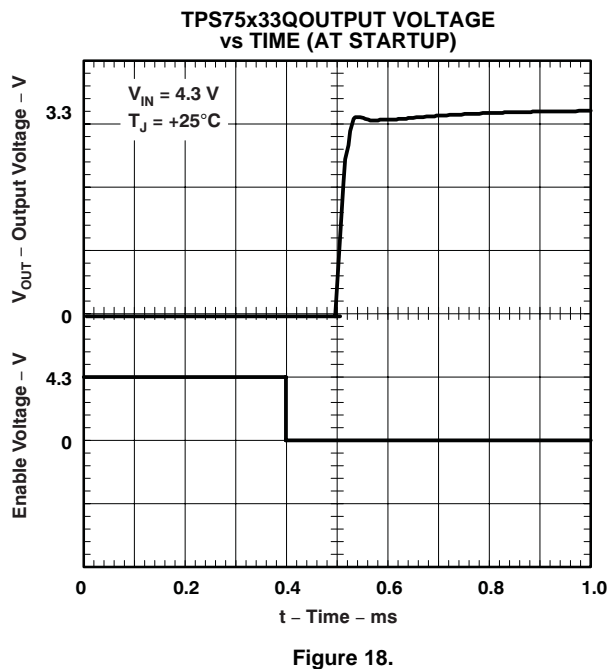
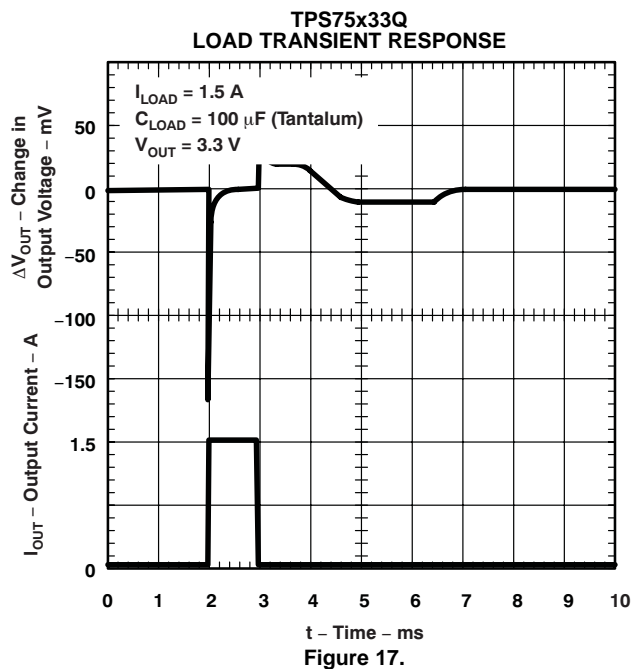
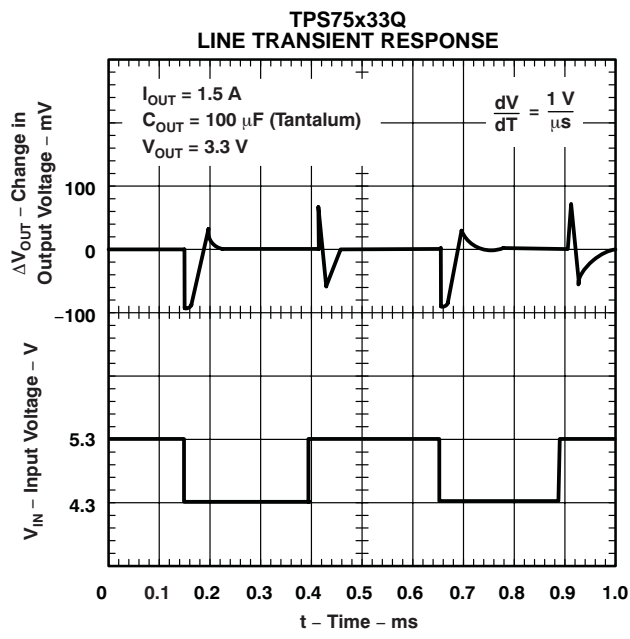
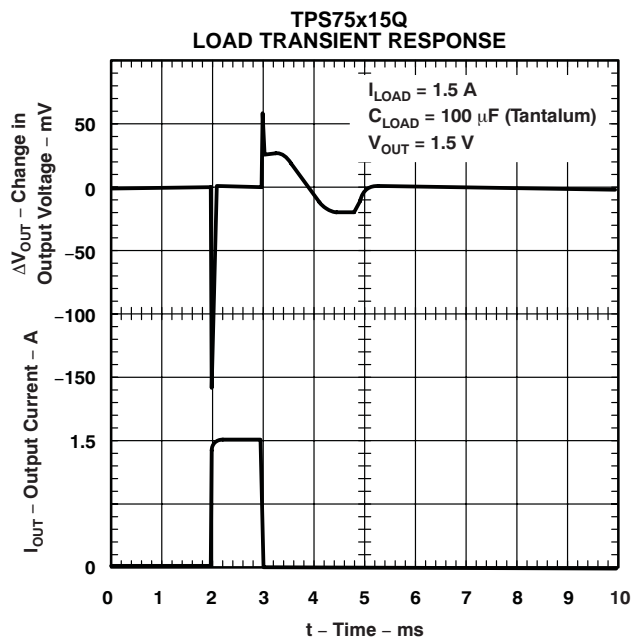

Figure 14.

TYPICAL CHARACTERISTICS (continued)

Over operating temperature range ($T_J = -40^{\circ}\text{C}$ to $+125^{\circ}\text{C}$) unless otherwise noted. Typical values are at $T_J = +25^{\circ}\text{C}$.



TYPICAL CHARACTERISTICS (continued)

Over operating temperature range ($T_J = -40^\circ\text{C}$ to $+125^\circ\text{C}$) unless otherwise noted. Typical values are at $T_J = +25^\circ\text{C}$.

Test Circuit for Typical Regions of Stability (Figure 20 and Figure 21) (Fixed Output Options)

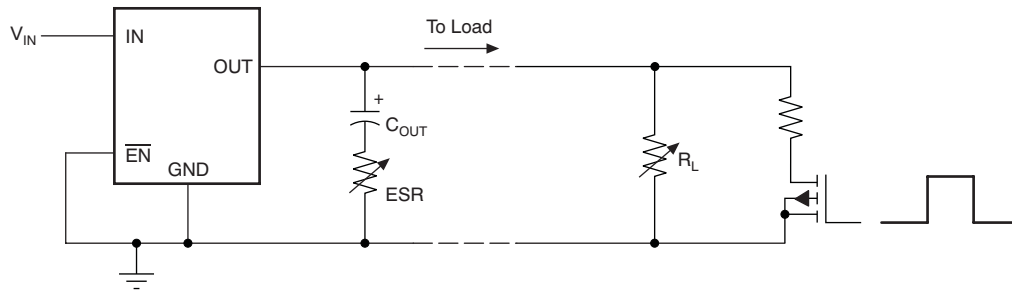

Figure 19.

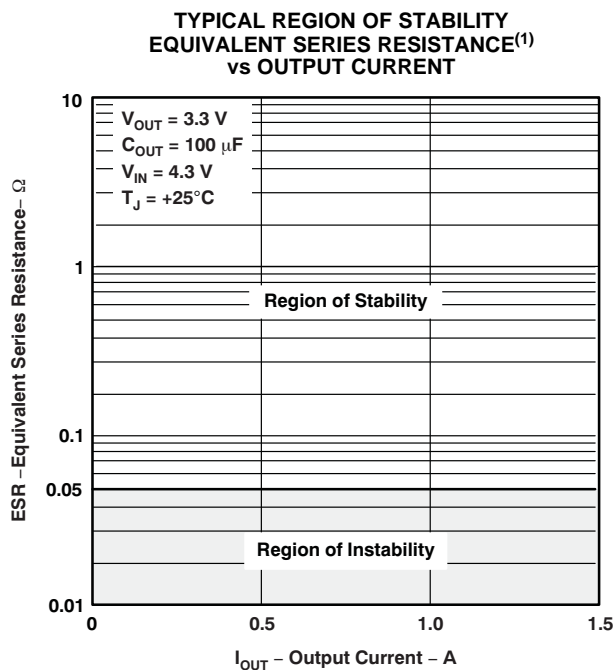

Figure 20.

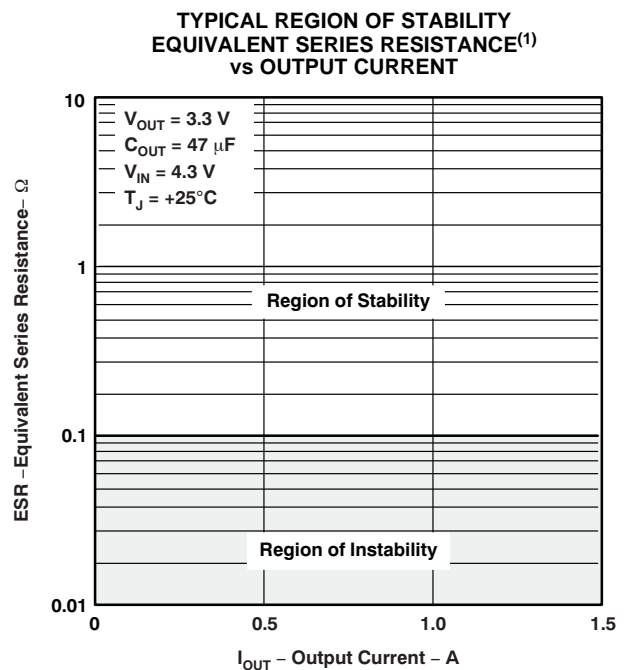

Figure 21.

(1). Equivalent series resistance (ESR) refers to the total series resistance, including the ESR of the capacitor, any series resistance added externally, and PWB trace resistance to C_{OUT} .

APPLICATION INFORMATION

The TPS751xxQ and TPS753xxQ devices include four fixed-output voltage regulators (1.5 V, 1.8 V, 2.5 V and 3.3 V), and an adjustable regulator, the TPS75x01Q (adjustable from 1.5 V to 5 V).

Minimum Load Requirements

The TPS751xxQ and TPS753xxQ families are stable even at zero load; no minimum load is required for operation.

Pin Functions

Enable (\overline{EN})

The \overline{EN} terminal is an input that enables or shuts down the device. If \overline{EN} is a logic high, the device is in shutdown mode. When \overline{EN} goes to logic low, then the device is enabled.

Power-Good (PG)—TPS751xxQ

The PG terminal is an open drain, active high output that indicates the status of V_{OUT} (output of the LDO). When V_{OUT} reaches 83% of the regulated voltage, PG goes to a high impedance state. It goes to a low-impedance state when V_{OUT} falls below 83% (that is, an overload condition) of the regulated voltage. The open drain output of the PG terminal requires a pullup resistor.

Sense (SENSE)

The SENSE terminal of the fixed output options must be connected to the regulator output, and the connection should be as short as possible. Internally, SENSE connects to a high-impedance wide-bandwidth amplifier through a resistor-divider network, and noise pickup feeds through to the regulator output. It is essential to route the SENSE connection in such a way to minimize/avoid noise pickup. Adding RC networks between the SENSE terminal and V_{OUT} to filter noise is not recommended because these types of networks may cause the regulator to oscillate.

Reset (\overline{RESET})—TPS753xxQ

The \overline{RESET} terminal is an open drain, active low output that indicates the status of V_{OUT} . When V_{OUT} reaches 95% of the regulated voltage, \overline{RESET} goes to a high-impedance state after a 100-ms delay. \overline{RESET} goes to a low-impedance state when V_{OUT} is below 95% of the regulated voltage. The open-drain output of the \overline{RESET} terminal requires a pullup resistor.

GND/HEATSINK

All GND/HEATSINK terminals are connected directly to the mount pad for thermal-enhanced operation. These terminals could be connected to GND or left floating.

Input Capacitor

For a typical application, an input bypass capacitor (0.22 μ F to 1 μ F) is recommended for device stability. This capacitor should be as close to the input pins as possible. For fast transient conditions where droop at the input of the LDO may occur because of high inrush current, it is recommended to place a larger capacitor at the input as well. The size of this capacitor depends on the output current and response time of the main power supply, as well as the distance to the load (LDO).

Output Capacitor

As with most LDO regulators, the TPS751xxQ and TPS753xxQ require an output capacitor connected between OUT and GND to stabilize the internal control loop. The minimum recommended capacitance value is 47 μ F and the ESR (equivalent series resistance) must be between 100 m Ω and 10 Ω . Solid tantalum electrolytic, aluminum electrolytic, and multilayer ceramic capacitors are all suitable, provided they meet the requirements described in this section. Larger capacitors provide a wider range of stability and better load transient response.

This information, along with the ESR graphs (see [Figure 20](#) and [Figure 21](#)), is included to assist in selection of suitable capacitance for the user's application. When necessary to achieve low height requirements along with high output current and/or high load capacitance, several higher ESR capacitors can be used in parallel to meet these guidelines.

ESR and Transient Response

LDOs typically require an external output capacitor for stability. In fast transient response applications, capacitors are used to support the load current while the LDO amplifier is responding. In most applications, one capacitor is used to support both functions.

Besides its capacitance, every capacitor also contains parasitic impedances. These parasitic impedances are resistive as well as inductive. The resistive impedance is called equivalent series resistance (ESR), and the inductive impedance is called equivalent series inductance (ESL). The equivalent schematic diagram of any capacitor can therefore be drawn as shown in [Figure 22](#).



Figure 22. ESR and ESL

In most cases one can neglect the effect of inductive impedance ESL. Therefore, the following application focuses mainly on the parasitic resistance ESR.

[Figure 23](#) shows the output capacitor and its parasitic impedances in a typical LDO output stage.

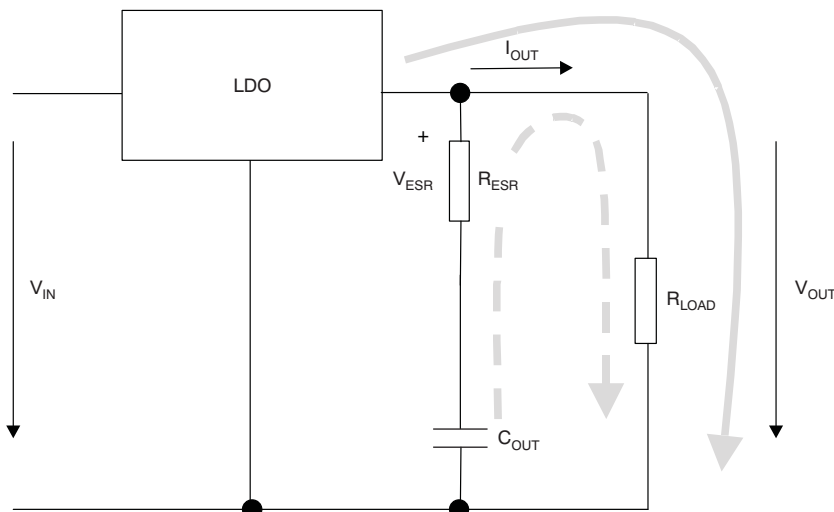

Figure 23. LDO Output Stage With Parasitic Resistances ESR and ESL

In steady state operation (dc state condition), the load current is supplied by the LDO (solid arrow) and the voltage across the capacitor is the same as the output voltage ($V(C_{OUT}) = V_{OUT}$). This condition means that no current is flowing into the C_{OUT} branch. If I_{OUT} suddenly increases (that is, a transient condition), the following events occur:

- The LDO is not able to supply the sudden current need because of its response time (t_1 in Figure 24). Therefore, capacitor C_{OUT} provides the current for the new load condition (the dashed arrow). C_{OUT} now acts like a battery with an internal resistance, ESR. Depending on the current demand at the output, a voltage drop occurs at R_{ESR} . This voltage is shown as V_{ESR} in Figure 23.
- When C_{OUT} is conducting current to the load, initial voltage at the load is $V_{OUT} = V(C_{OUT}) - V_{ESR}$. As a result of the discharge of C_{OUT} , the output voltage V_{OUT} drops continuously until the response time t_1 of the LDO is reached and the LDO resumes supplying the load. From this point, the output voltage starts rising again until it reaches the regulated voltage. This period is shown as t_2 in Figure 24.

Figure 24 also shows the impact of different ESRs on the output voltage. The left brackets show different levels of ESRs where number 1 displays the lowest and number 3 displays the highest ESR.

From the above discussion, the following conclusions can be drawn:

- The higher the ESR, the larger the droop at the beginning of load transient.
- The smaller the output capacitor, the faster the discharge time and the bigger the voltage droop during the LDO response period.

Conclusion

To minimize the transient output droop, capacitors must have a low ESR and be large enough to support the minimum output voltage requirement.

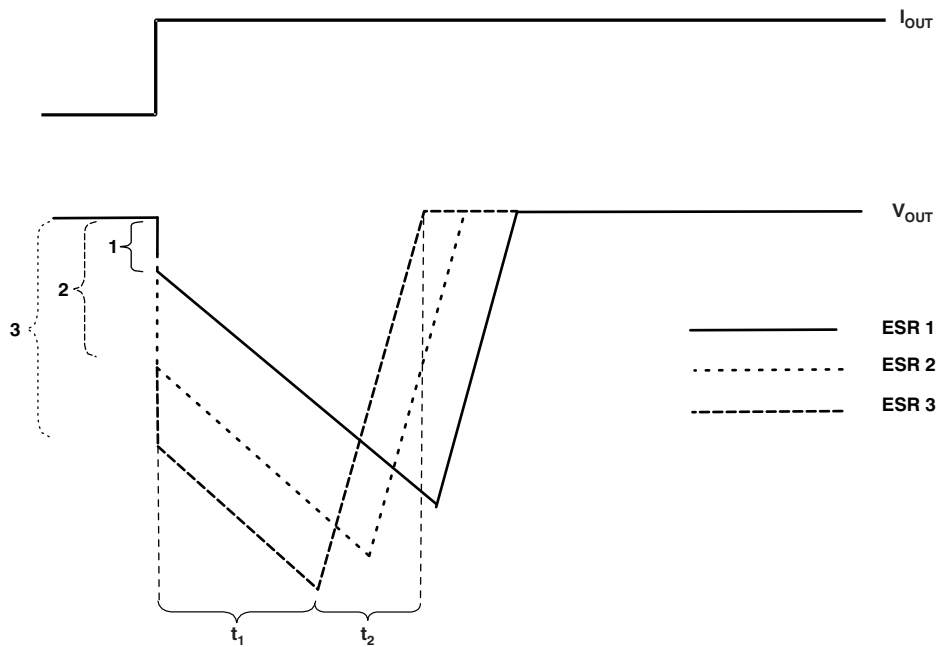

Figure 24. Correlation of Different ESRs and Their Influence to the Regulation of V_{OUT} at a Load Step From Low-to-High Output Current

Programming the TPS75x01Q Adjustable LDO Regulator

The output voltage of the TPS77x01Q adjustable regulator is programmed using an external resistor divider as shown in Figure 25. The output voltage is calculated using Equation 1:

$$V_{OUT} = V_{ref} \times \left(1 + \frac{R_1}{R_2}\right) \quad (1)$$

Where:

- $V_{ref} = 1.1834 \text{ V typ}$ (the internal reference voltage)

Resistors R_1 and R_2 should be chosen for approximately $40\mu\text{A}$ divider current. Lower value resistors can be used, but offer no inherent advantage and waste more power. Higher values should be avoided as leakage currents at FB increase the output voltage error. The recommended design procedure is to choose $R_2 = 30.1 \text{ k}\Omega$ to set the divider current at approximately $40\mu\text{A}$ and then calculate R_1 using Equation 2:

$$R_1 = \left(\frac{V_{OUT}}{V_{ref}} - 1\right) \times R_2 \quad (2)$$

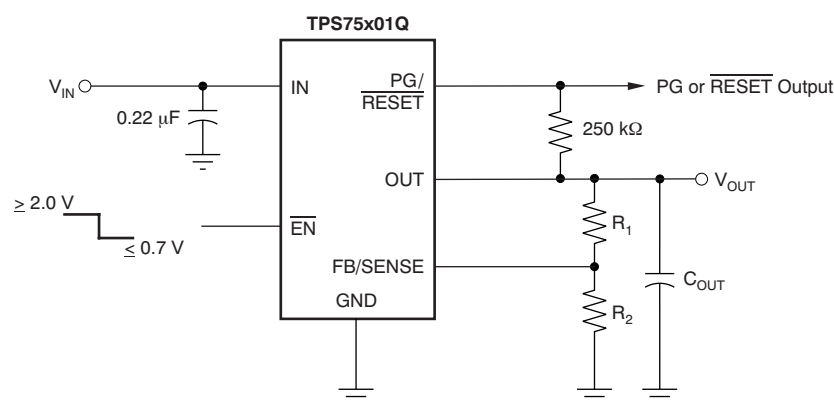

OUTPUT VOLTAGE
PROGRAMMING GUIDE

OUTPUT VOLTAGE	R_1	R_2	UNIT
2.5 V	33.2	30.1	$\text{k}\Omega$
3.3 V	53.6	30.1	$\text{k}\Omega$
3.6 V	61.9	30.1	$\text{k}\Omega$

NOTE: To reduce noise and prevent oscillation, R_1 and R_2 must be as close as possible to the FB/SENSE terminal.

Figure 25. TPS75x01Q Adjustable LDO Regulator Programming

Regulator Protection

The TPS751xxQ and TPS753xxQ PMOS-pass transistors have a built-in back diode that conducts reverse currents when the input voltage drops below the output voltage (for example, during power down). Current is conducted from the output to the input and is not internally limited. When extended reverse voltage is anticipated, external limiting may be appropriate.

The TPS751xxQ and TPS753xxQ also feature internal current limiting and thermal protection. During normal operation, the TPS751xxQ and TPS753xxQ limit output current to approximately 3.3 A. When current limiting engages, the output voltage scales back linearly until the overcurrent condition ends. While current limiting is designed to prevent gross device failure, care should be taken not to exceed the power dissipation ratings of the package. If the temperature of the device exceeds $+150^\circ\text{C}$ (typ), thermal-protection circuitry shuts it down. Once the device has cooled below $+130^\circ\text{C}$ (typ), regulator operation resumes.

Power Dissipation and Junction Temperature

Specified regulator operation is assured to a junction temperature of +125°C; the maximum junction temperature should be restricted to +125°C under normal operating conditions. This restriction limits the power dissipation the regulator can handle in any given application. To ensure the junction temperature is within acceptable limits, calculate the maximum allowable dissipation, $P_{D(max)}$, and the actual dissipation, P_D , which must be less than or equal to $P_{D(max)}$.

The maximum-power-dissipation limit is determined using [Equation 3](#):

$$P_{D(Max)} = \frac{T_{J(Max)} - T_A}{R_{\theta JA}} \quad (3)$$

where:

- $T_{J(max)}$ is the maximum allowable junction temperature
- $R_{\theta JA}$ is the thermal resistance junction-to-ambient for the package; that is, 34.6°C/W for the 20-terminal PWP with no airflow (see [Dissipation Ratings Table](#)).
- T_A is the ambient temperature

The regulator dissipation is calculated using [Equation 4](#):

$$P_D = (V_{IN} - V_{OUT}) \times I_{OUT} \quad (4)$$

Power dissipation resulting from quiescent current is negligible. Excessive power dissipation triggers the thermal protection circuit.

THERMAL INFORMATION

Thermally-Enhanced TSSOP-20 (PWP–PowerPAD)

The thermally-enhanced PWP package is based on the 20-pin TSSOP, but includes a thermal pad [see [Figure 26\(c\)](#)] to provide an effective thermal contact between the IC and the printed wiring board (PWB).

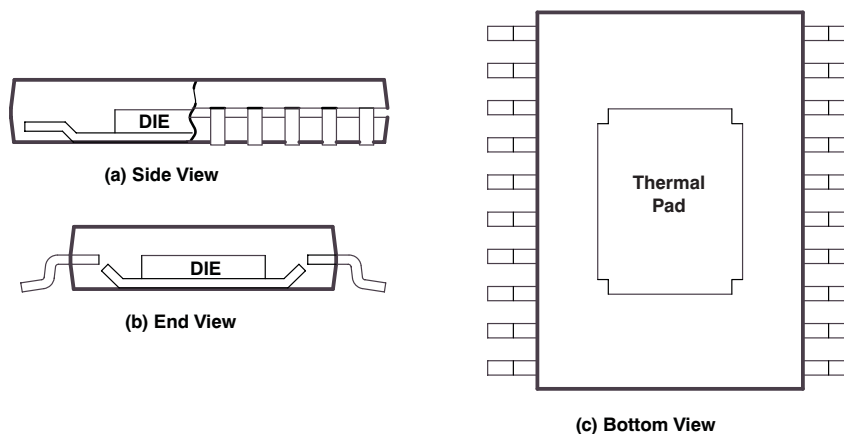

Figure 26. Views of Thermally-Enhanced PWP Package

Traditionally, surface mount and power have been mutually exclusive terms. A variety of scaled-down TO220-type packages have leads formed as gull wings to make them applicable for surface-mount applications. These packages, however, suffer from several shortcomings: they do not address the very low profile requirements (less than 2 mm) of many of today's advanced systems, and they do not offer a pin-count high enough to accommodate increasing integration. On the other hand, traditional low-power surface-mount packages require power dissipation derating that severely limits the usable range of many high-performance analog circuits.

The PWP package (a thermally-enhanced TSSOP) combines fine-pitch surface-mount technology with thermal performance comparable to much larger power packages.

The PWP package is designed to optimize the heat transfer to the PWB. Because of the very small size and limited mass of a TSSOP package, thermal enhancement is achieved by improving the thermal conduction paths that remove heat from the component. The thermal pad is formed using a lead-frame design (patent pending) and manufacturing technique to provide the user with direct connection to the heat-generating IC. When this pad is soldered or otherwise coupled to an external heat dissipator, high power dissipation in the ultra-thin, fine-pitch, surface-mount package can be reliably achieved.

Because the conduction path has been enhanced, power-dissipation capability is determined by the thermal considerations in the PWB design. For example, simply adding a localized copper plane (heatsink surface) that is coupled to the thermal pad enables the PWP package to dissipate 2.5 W in free air (see Figure 28(a), 8 cm² of copper heatsink and natural convection). Increasing the heatsink size increases the power dissipation range for the component. The power dissipation limit can be further improved by adding airflow to a PWB/IC assembly (see Figure 27 and Figure 28). The line drawn at 0.3 cm² in Figure 27 and Figure 28 indicates performance at the minimum recommended heatsink size, illustrated in Figure 30.

The thermal pad is directly connected to the substrate of the IC, which for the TPS751xxQPWP and TPS753xxQPWP series is a secondary electrical connection to device ground. The heat-sink surface that is added to the PWP can be a ground plane or left electrically isolated. In TO220-type surface-mount packages, the thermal connection is also the primary electrical connection for a given terminal which is not always ground. The PWP package provides up to 16 independent leads that can be used as inputs and outputs. (Note: leads 1, 10, 11, and 20 are internally connected to the thermal pad and the IC substrate.)

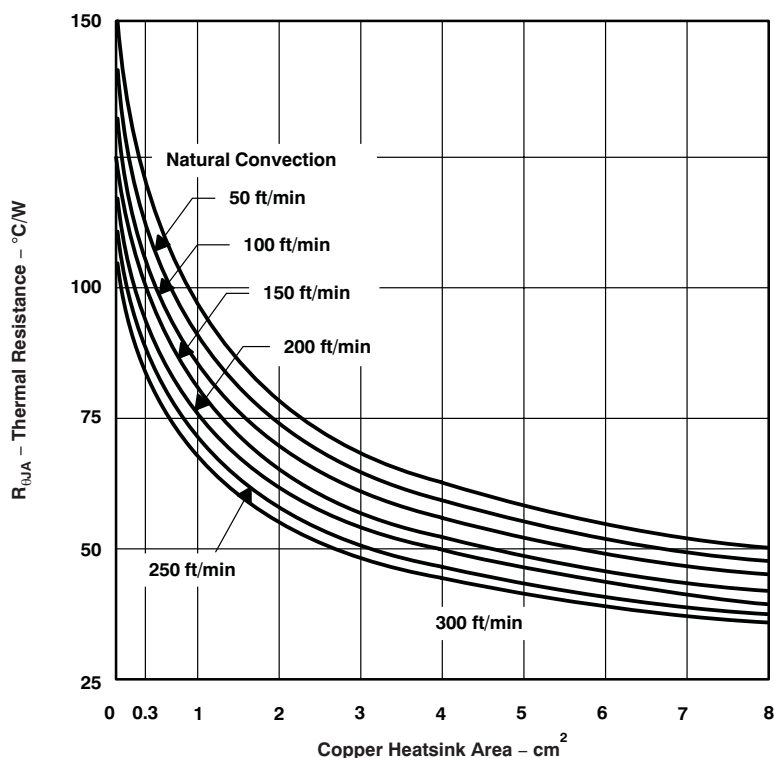
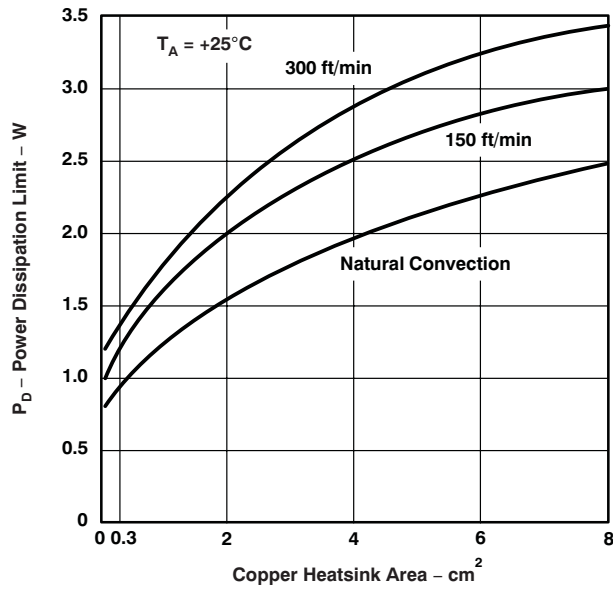
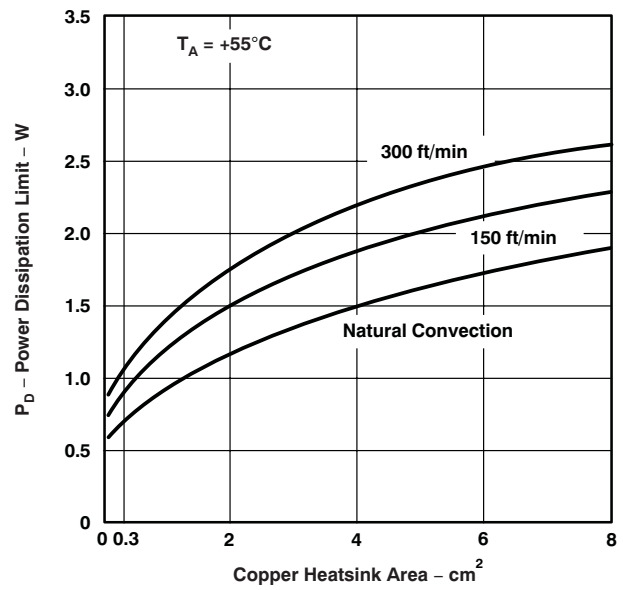

Figure 27. Thermal Resistance vs Copper Heatsink Area



(a)



(b)

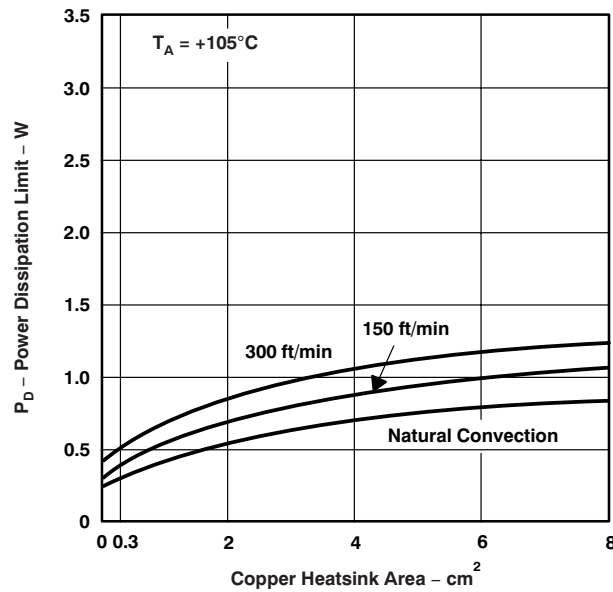

(c)

Figure 28. Power Ratings of the PWP Package at Ambient Temperatures of +25°C, +55°C, and +105°C

Figure 29 is an example of a thermally-enhanced PWB layout for use with the new PWP package. This board configuration was used in the thermal experiments that generated the power ratings shown in Figure 27 and Figure 28. As discussed earlier, copper has been added on the PWB to conduct heat away from the device. $R_{\theta JA}$ for this assembly is illustrated in Figure 27 as a function of heatsink area. A family of curves is included to illustrate the effect of airflow introduced into the system.

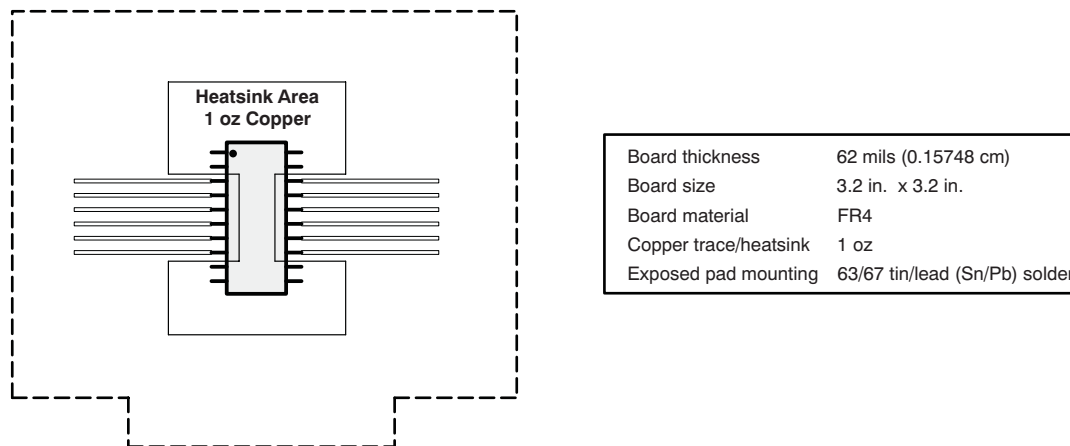

Figure 29. PWB Layout (Including Copper Heatsink Area) for Thermally-Enhanced PWP Package

From Figure 27, $R_{\theta JA}$ for a PWB assembly can be determined and used to calculate the maximum power-dissipation limit for the component/PWB assembly, with the equation:

$$P_{D(\text{Max})} = \frac{T_{J(\text{Max})} - T_A}{R_{\theta JA (\text{System})}} \quad (5)$$

Where $T_{J\text{max}}$ is the maximum specified junction temperature (+150°C absolute maximum limit, +125°C recommended operating limit) and T_A is the ambient temperature.

$P_{D(\text{max})}$ should then be applied to the internal power dissipated by the TPS75133QPWP regulator. The equation for calculating total internal power dissipation of the TPS75133QPWP is:

$$P_{D(\text{total})} = (V_{\text{IN}} - V_{\text{OUT}}) \times I_{\text{OUT}} + V_{\text{IN}} \times I_{\text{Q}} \quad (6)$$

Because the quiescent current of the TPS75133QPWP is very low, the second term is negligible, further simplifying the equation to:

$$P_{D(\text{total})} = (V_{\text{IN}} - V_{\text{OUT}}) \times I_{\text{OUT}} \quad (7)$$

For the case where $T_A = +55^\circ\text{C}$, airflow = 200 ft/min, copper heat-sink area = 4 cm², the maximum power-dissipation limit can be calculated. First, from Figure 27, we find the system $R_{\theta JA}$ is 50°C/W; therefore, the maximum power-dissipation limit is:

$$P_{D(\text{Max})} = \frac{T_{J(\text{Max})} - T_A}{R_{\theta JA (\text{System})}} = \frac{125^\circ\text{C} - 55^\circ\text{C}}{50^\circ\text{C/W}} = 1.4 \text{ W} \quad (8)$$

If the system implements a TPS75133QPWP regulator, where $V_{\text{IN}} = 5 \text{ V}$ and $I_{\text{OUT}} = 800 \text{ mA}$, the internal power dissipation is:

$$P_{D(\text{total})} = (V_{\text{IN}} - V_{\text{OUT}}) \times I_{\text{OUT}} = (5 - 3.3) \times 0.8 = 1.36 \text{ W} \quad (9)$$

Comparing $P_{D(\text{total})}$ with $P_{D(\text{max})}$ reveals that the power dissipation in this example does not exceed the calculated limit. When it does, one of two corrective actions should be made: either raise the power-dissipation limit by increasing the airflow or the heat-sink area, or lower the internal power dissipation of the regulator by reducing the input voltage or the load current. In either case, the above calculations should be repeated with the new system parameters.

Mounting Information

The primary requirement is to complete the thermal contact between the thermal pad and the PWB metal. The thermal pad is a solderable surface and is fully intended to be soldered at the time the component is mounted. Although voiding in the thermal-pad solder-connection is not desirable, up to 50% voiding is acceptable. The data included in [Figure 27](#) and [Figure 28](#) are for soldered connections with voiding between 20% and 50%. The thermal analysis shows no significant difference resulting from the variation in voiding percentage.

[Figure 30](#) shows the solder-mask land pattern for the PWP package. The minimum recommended heat-sink area is also illustrated. This is simply a copper plane under the body extent of the package, including metal routed under terminals 1, 10, 11, and 20.

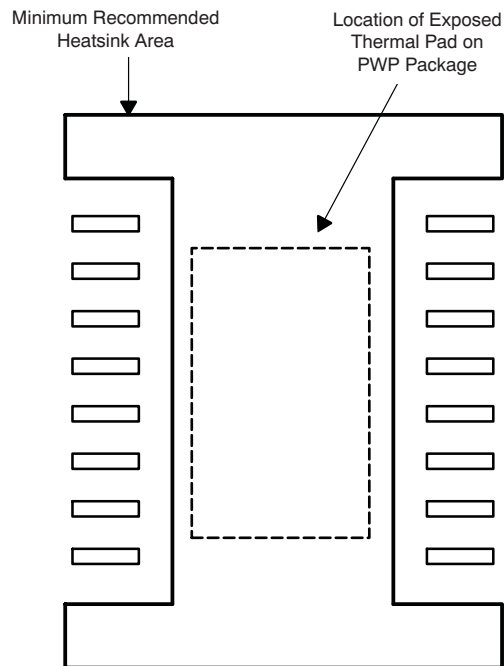

Figure 30. PWP Package Land Pattern

PACKAGING INFORMATION

Orderable Device	Status (1)	Package Type	Package Drawing	Pins	Package Qty	Eco Plan (2)	Lead/Ball Finish (6)	MSL Peak Temp (3)	Op Temp (°C)	Device Marking (4/5)	Samples
TPS75101QPWP	ACTIVE	HTSSOP	PWP	20	70	Green (RoHS & no Sb/Br)	CU NIPDAU	Level-2-260C-1 YEAR	-40 to 125	PT75101	Samples
TPS75101QPWPR	ACTIVE	HTSSOP	PWP	20	2000	Green (RoHS & no Sb/Br)	CU NIPDAU	Level-2-260C-1 YEAR	-40 to 125	PT75101	Samples
TPS75115QPWP	ACTIVE	HTSSOP	PWP	20	70	Green (RoHS & no Sb/Br)	CU NIPDAU	Level-2-260C-1 YEAR	-40 to 125	PT75115	Samples
TPS75115QPWPR	ACTIVE	HTSSOP	PWP	20	2000	Green (RoHS & no Sb/Br)	CU NIPDAU	Level-2-260C-1 YEAR	-40 to 125	PT75115	Samples
TPS75118QPWP	ACTIVE	HTSSOP	PWP	20	70	Green (RoHS & no Sb/Br)	CU NIPDAU	Level-2-260C-1 YEAR	-40 to 125	PT75118	Samples
TPS75118QPWPR	ACTIVE	HTSSOP	PWP	20	2000	Green (RoHS & no Sb/Br)	CU NIPDAU	Level-2-260C-1 YEAR	-40 to 125	PT75118	Samples
TPS75125QPWP	ACTIVE	HTSSOP	PWP	20	70	Green (RoHS & no Sb/Br)	CU NIPDAU	Level-2-260C-1 YEAR	-40 to 125	PT75125	Samples
TPS75125QPWPG4	ACTIVE	HTSSOP	PWP	20	70	Green (RoHS & no Sb/Br)	CU NIPDAU	Level-2-260C-1 YEAR	-40 to 125	PT75125	Samples
TPS75125QPWPR	ACTIVE	HTSSOP	PWP	20	2000	Green (RoHS & no Sb/Br)	CU NIPDAU	Level-2-260C-1 YEAR	-40 to 125	PT75125	Samples
TPS75133QPWP	ACTIVE	HTSSOP	PWP	20	70	Green (RoHS & no Sb/Br)	CU NIPDAU	Level-2-260C-1 YEAR	-40 to 125	PT75133	Samples
TPS75133QPWPR	ACTIVE	HTSSOP	PWP	20	2000	Green (RoHS & no Sb/Br)	CU NIPDAU	Level-2-260C-1 YEAR	-40 to 125	PT75133	Samples
TPS75301QPWP	ACTIVE	HTSSOP	PWP	20	70	Green (RoHS & no Sb/Br)	CU NIPDAU	Level-2-260C-1 YEAR	-40 to 125	PT75301	Samples
TPS75301QPWPR	ACTIVE	HTSSOP	PWP	20	2000	Green (RoHS & no Sb/Br)	CU NIPDAU	Level-2-260C-1 YEAR	-40 to 125	PT75301	Samples
TPS75315QPWP	ACTIVE	HTSSOP	PWP	20	70	Green (RoHS & no Sb/Br)	CU NIPDAU	Level-2-260C-1 YEAR	-40 to 125	PT75315	Samples
TPS75318QPWP	ACTIVE	HTSSOP	PWP	20	70	Green (RoHS & no Sb/Br)	CU NIPDAU	Level-2-260C-1 YEAR	-40 to 125	PT75318	Samples
TPS75318QPWPR	ACTIVE	HTSSOP	PWP	20	2000	Green (RoHS & no Sb/Br)	CU NIPDAU	Level-2-260C-1 YEAR	-40 to 125	PT75318	Samples
TPS75325QPWP	ACTIVE	HTSSOP	PWP	20	70	Green (RoHS & no Sb/Br)	CU NIPDAU	Level-2-260C-1 YEAR	-40 to 125	PT75325	Samples

Orderable Device	Status (1)	Package Type	Package Drawing	Pins	Package Qty	Eco Plan (2)	Lead/Ball Finish (6)	MSL Peak Temp (3)	Op Temp (°C)	Device Marking (4/5)	Samples
TPS75325QPWPR	ACTIVE	HTSSOP	PWP	20	2000	Green (RoHS & no Sb/Br)	CU NIPDAU	Level-2-260C-1 YEAR	-40 to 125	PT75325	Samples
TPS75333QPWP	ACTIVE	HTSSOP	PWP	20	70	Green (RoHS & no Sb/Br)	CU NIPDAU	Level-2-260C-1 YEAR	-40 to 125	PT75333	Samples
TPS75333QPWPR	ACTIVE	HTSSOP	PWP	20	2000	Green (RoHS & no Sb/Br)	CU NIPDAU	Level-2-260C-1 YEAR	-40 to 125	PT75333	Samples
TPS75333QPWPRG4	ACTIVE	HTSSOP	PWP	20	2000	Green (RoHS & no Sb/Br)	CU NIPDAU	Level-2-260C-1 YEAR	-40 to 125	PT75333	Samples

(1) The marketing status values are defined as follows:

ACTIVE: Product device recommended for new designs.

LIFEBUY: TI has announced that the device will be discontinued, and a lifetime-buy period is in effect.

NRND: Not recommended for new designs. Device is in production to support existing customers, but TI does not recommend using this part in a new design.

PREVIEW: Device has been announced but is not in production. Samples may or may not be available.

OBSOLETE: TI has discontinued the production of the device.

(2) **RoHS:** TI defines "RoHS" to mean semiconductor products that are compliant with the current EU RoHS requirements for all 10 RoHS substances, including the requirement that RoHS substance do not exceed 0.1% by weight in homogeneous materials. Where designed to be soldered at high temperatures, "RoHS" products are suitable for use in specified lead-free processes. TI may reference these types of products as "Pb-Free".

RoHS Exempt: TI defines "RoHS Exempt" to mean products that contain lead but are compliant with EU RoHS pursuant to a specific EU RoHS exemption.

Green: TI defines "Green" to mean the content of Chlorine (Cl) and Bromine (Br) based flame retardants meet JS709B low halogen requirements of <=1000ppm threshold. Antimony trioxide based flame retardants must also meet the <=1000ppm threshold requirement.

(3) MSL, Peak Temp. - The Moisture Sensitivity Level rating according to the JEDEC industry standard classifications, and peak solder temperature.

(4) There may be additional marking, which relates to the logo, the lot trace code information, or the environmental category on the device.

(5) Multiple Device Markings will be inside parentheses. Only one Device Marking contained in parentheses and separated by a "~" will appear on a device. If a line is indented then it is a continuation of the previous line and the two combined represent the entire Device Marking for that device.

(6) Lead/Ball Finish - Orderable Devices may have multiple material finish options. Finish options are separated by a vertical ruled line. Lead/Ball Finish values may wrap to two lines if the finish value exceeds the maximum column width.

Important Information and Disclaimer: The information provided on this page represents TI's knowledge and belief as of the date that it is provided. TI bases its knowledge and belief on information provided by third parties, and makes no representation or warranty as to the accuracy of such information. Efforts are underway to better integrate information from third parties. TI has taken and continues to take reasonable steps to provide representative and accurate information but may not have conducted destructive testing or chemical analysis on incoming materials and chemicals. TI and TI suppliers consider certain information to be proprietary, and thus CAS numbers and other limited information may not be available for release.

In no event shall TI's liability arising out of such information exceed the total purchase price of the TI part(s) at issue in this document sold by TI to Customer on an annual basis.

TAPE AND REEL INFORMATION

QUADRANT ASSIGNMENTS FOR PIN 1 ORIENTATION IN TAPE

*All dimensions are nominal

Device	Package Type	Package Drawing	Pins	SPQ	Reel Diameter (mm)	Reel Width W1 (mm)	A0 (mm)	B0 (mm)	K0 (mm)	P1 (mm)	W (mm)	Pin1 Quadrant
TPS75101QPWPR	HTSSOP	PWP	20	2000	330.0	16.4	6.95	7.1	1.6	8.0	16.0	Q1
TPS75115QPWPR	HTSSOP	PWP	20	2000	330.0	16.4	6.95	7.1	1.6	8.0	16.0	Q1
TPS75118QPWPR	HTSSOP	PWP	20	2000	330.0	16.4	6.95	7.1	1.6	8.0	16.0	Q1
TPS75125QPWPR	HTSSOP	PWP	20	2000	330.0	16.4	6.95	7.1	1.6	8.0	16.0	Q1
TPS75133QPWPR	HTSSOP	PWP	20	2000	330.0	16.4	6.95	7.1	1.6	8.0	16.0	Q1
TPS75301QPWPR	HTSSOP	PWP	20	2000	330.0	16.4	6.95	7.1	1.6	8.0	16.0	Q1
TPS75318QPWPR	HTSSOP	PWP	20	2000	330.0	16.4	6.95	7.1	1.6	8.0	16.0	Q1
TPS75325QPWPR	HTSSOP	PWP	20	2000	330.0	16.4	6.95	7.1	1.6	8.0	16.0	Q1
TPS75333QPWPR	HTSSOP	PWP	20	2000	330.0	16.4	6.95	7.1	1.6	8.0	16.0	Q1

TAPE AND REEL BOX DIMENSIONS

*All dimensions are nominal

Device	Package Type	Package Drawing	Pins	SPQ	Length (mm)	Width (mm)	Height (mm)
TPS75101QPWPR	HTSSOP	PWP	20	2000	367.0	367.0	38.0
TPS75115QPWPR	HTSSOP	PWP	20	2000	367.0	367.0	38.0
TPS75118QPWPR	HTSSOP	PWP	20	2000	367.0	367.0	38.0
TPS75125QPWPR	HTSSOP	PWP	20	2000	367.0	367.0	38.0
TPS75133QPWPR	HTSSOP	PWP	20	2000	367.0	367.0	38.0
TPS75301QPWPR	HTSSOP	PWP	20	2000	367.0	367.0	38.0
TPS75318QPWPR	HTSSOP	PWP	20	2000	367.0	367.0	38.0
TPS75325QPWPR	HTSSOP	PWP	20	2000	367.0	367.0	38.0
TPS75333QPWPR	HTSSOP	PWP	20	2000	367.0	367.0	38.0

MECHANICAL DATA

PWP (R-PDSO-G20)

PowerPAD™ PLASTIC SMALL OUTLINE



- NOTES:
- All linear dimensions are in millimeters.
 - This drawing is subject to change without notice.
 - Body dimensions do not include mold flash or protrusions. Mold flash and protrusion shall not exceed 0.15 per side.
 - This package is designed to be soldered to a thermal pad on the board. Refer to Technical Brief, PowerPad Thermally Enhanced Package, Texas Instruments Literature No. SLMA002 for information regarding recommended board layout. This document is available at www.ti.com <<http://www.ti.com>>.
 - See the additional figure in the Product Data Sheet for details regarding the exposed thermal pad features and dimensions.
 - Falls within JEDEC MO-153

PowerPAD is a trademark of Texas Instruments.

THERMAL PAD MECHANICAL DATA

PWP (R-PDSO-G20) PowerPAD™ SMALL PLASTIC OUTLINE

THERMAL INFORMATION

This PowerPAD™ package incorporates an exposed thermal pad that is designed to be attached to a printed circuit board (PCB). The thermal pad must be soldered directly to the PCB. After soldering, the PCB can be used as a heatsink. In addition, through the use of thermal vias, the thermal pad can be attached directly to the appropriate copper plane shown in the electrical schematic for the device, or alternatively, can be attached to a special heatsink structure designed into the PCB. This design optimizes the heat transfer from the integrated circuit (IC).

For additional information on the PowerPAD package and how to take advantage of its heat dissipating abilities, refer to Technical Brief, PowerPAD Thermally Enhanced Package, Texas Instruments Literature No. SLMA002 and Application Brief, PowerPAD Made Easy, Texas Instruments Literature No. SLMA004. Both documents are available at www.ti.com.

The exposed thermal pad dimensions for this package are shown in the following illustration.

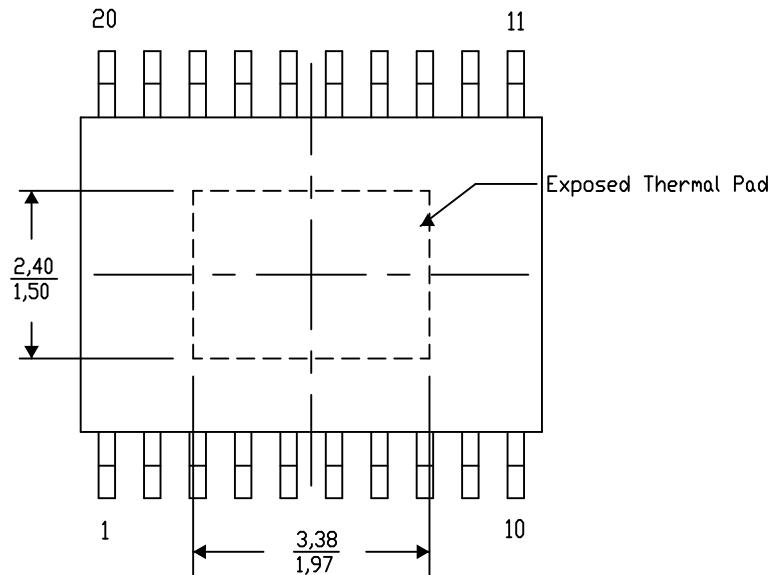

Top View

Exposed Thermal Pad Dimensions

4206332-19/AO 01/16

NOTE: A. All linear dimensions are in millimeters

PowerPAD is a trademark of Texas Instruments

PWP (R-PDSO-G20)

PowerPAD™ PLASTIC SMALL OUTLINE

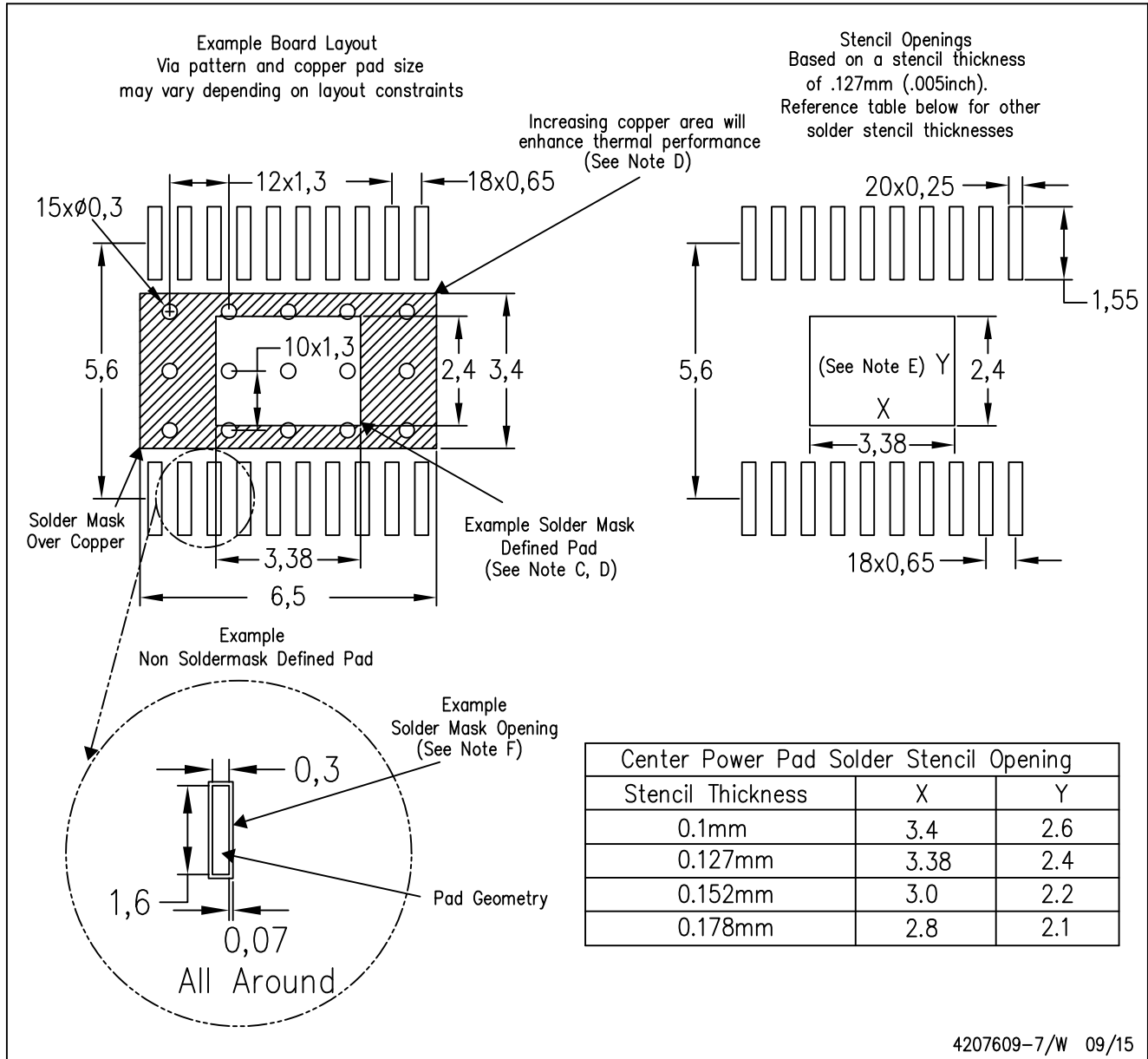

- NOTES:
- A. All linear dimensions are in millimeters.
 - B. This drawing is subject to change without notice.
 - C. Customers should place a note on the circuit board fabrication drawing not to alter the center solder mask defined pad.
 - D. This package is designed to be soldered to a thermal pad on the board. Refer to Technical Brief, PowerPad Thermally Enhanced Package, Texas Instruments Literature No. SLMA002, SLMA004, and also the Product Data Sheets for specific thermal information, via requirements, and recommended board layout. These documents are available at www.ti.com <<http://www.ti.com>>. Publication IPC-7351 is recommended for alternate designs.
 - E. Laser cutting apertures with trapezoidal walls and also rounding corners will offer better paste release. Customers should contact their board assembly site for stencil design recommendations. Example stencil design based on a 50% volumetric metal load solder paste. Refer to IPC-7525 for other stencil recommendations.
 - F. Customers should contact their board fabrication site for solder mask tolerances between and around signal pads.

IMPORTANT NOTICE

Texas Instruments Incorporated (TI) reserves the right to make corrections, enhancements, improvements and other changes to its semiconductor products and services per JESD46, latest issue, and to discontinue any product or service per JESD48, latest issue. Buyers should obtain the latest relevant information before placing orders and should verify that such information is current and complete.

TI's published terms of sale for semiconductor products (<http://www.ti.com/sc/docs/stdterms.htm>) apply to the sale of packaged integrated circuit products that TI has qualified and released to market. Additional terms may apply to the use or sale of other types of TI products and services.

Reproduction of significant portions of TI information in TI data sheets is permissible only if reproduction is without alteration and is accompanied by all associated warranties, conditions, limitations, and notices. TI is not responsible or liable for such reproduced documentation. Information of third parties may be subject to additional restrictions. Resale of TI products or services with statements different from or beyond the parameters stated by TI for that product or service voids all express and any implied warranties for the associated TI product or service and is an unfair and deceptive business practice. TI is not responsible or liable for any such statements.

Buyers and others who are developing systems that incorporate TI products (collectively, "Designers") understand and agree that Designers remain responsible for using their independent analysis, evaluation and judgment in designing their applications and that Designers have full and exclusive responsibility to assure the safety of Designers' applications and compliance of their applications (and of all TI products used in or for Designers' applications) with all applicable regulations, laws and other applicable requirements. Designer represents that, with respect to their applications, Designer has all the necessary expertise to create and implement safeguards that (1) anticipate dangerous consequences of failures, (2) monitor failures and their consequences, and (3) lessen the likelihood of failures that might cause harm and take appropriate actions. Designer agrees that prior to using or distributing any applications that include TI products, Designer will thoroughly test such applications and the functionality of such TI products as used in such applications.

TI's provision of technical, application or other design advice, quality characterization, reliability data or other services or information, including, but not limited to, reference designs and materials relating to evaluation modules, (collectively, "TI Resources") are intended to assist designers who are developing applications that incorporate TI products; by downloading, accessing or using TI Resources in any way, Designer (individually or, if Designer is acting on behalf of a company, Designer's company) agrees to use any particular TI Resource solely for this purpose and subject to the terms of this Notice.

TI's provision of TI Resources does not expand or otherwise alter TI's applicable published warranties or warranty disclaimers for TI products, and no additional obligations or liabilities arise from TI providing such TI Resources. TI reserves the right to make corrections, enhancements, improvements and other changes to its TI Resources. TI has not conducted any testing other than that specifically described in the published documentation for a particular TI Resource.

Designer is authorized to use, copy and modify any individual TI Resource only in connection with the development of applications that include the TI product(s) identified in such TI Resource. NO OTHER LICENSE, EXPRESS OR IMPLIED, BY ESTOPPEL OR OTHERWISE TO ANY OTHER TI INTELLECTUAL PROPERTY RIGHT, AND NO LICENSE TO ANY TECHNOLOGY OR INTELLECTUAL PROPERTY RIGHT OF TI OR ANY THIRD PARTY IS GRANTED HEREIN, including but not limited to any patent right, copyright, mask work right, or other intellectual property right relating to any combination, machine, or process in which TI products or services are used. Information regarding or referencing third-party products or services does not constitute a license to use such products or services, or a warranty or endorsement thereof. Use of TI Resources may require a license from a third party under the patents or other intellectual property of the third party, or a license from TI under the patents or other intellectual property of TI.

TI RESOURCES ARE PROVIDED "AS IS" AND WITH ALL FAULTS. TI DISCLAIMS ALL OTHER WARRANTIES OR REPRESENTATIONS, EXPRESS OR IMPLIED, REGARDING RESOURCES OR USE THEREOF, INCLUDING BUT NOT LIMITED TO ACCURACY OR COMPLETENESS, TITLE, ANY EPIDEMIC FAILURE WARRANTY AND ANY IMPLIED WARRANTIES OF MERCHANTABILITY, FITNESS FOR A PARTICULAR PURPOSE, AND NON-INFRINGEMENT OF ANY THIRD PARTY INTELLECTUAL PROPERTY RIGHTS. TI SHALL NOT BE LIABLE FOR AND SHALL NOT DEFEND OR INDEMNIFY DESIGNER AGAINST ANY CLAIM, INCLUDING BUT NOT LIMITED TO ANY INFRINGEMENT CLAIM THAT RELATES TO OR IS BASED ON ANY COMBINATION OF PRODUCTS EVEN IF DESCRIBED IN TI RESOURCES OR OTHERWISE. IN NO EVENT SHALL TI BE LIABLE FOR ANY ACTUAL, DIRECT, SPECIAL, COLLATERAL, INDIRECT, PUNITIVE, INCIDENTAL, CONSEQUENTIAL OR EXEMPLARY DAMAGES IN CONNECTION WITH OR ARISING OUT OF TI RESOURCES OR USE THEREOF, AND REGARDLESS OF WHETHER TI HAS BEEN ADVISED OF THE POSSIBILITY OF SUCH DAMAGES.

Unless TI has explicitly designated an individual product as meeting the requirements of a particular industry standard (e.g., ISO/TS 16949 and ISO 26262), TI is not responsible for any failure to meet such industry standard requirements.

Where TI specifically promotes products as facilitating functional safety or as compliant with industry functional safety standards, such products are intended to help enable customers to design and create their own applications that meet applicable functional safety standards and requirements. Using products in an application does not by itself establish any safety features in the application. Designers must ensure compliance with safety-related requirements and standards applicable to their applications. Designer may not use any TI products in life-critical medical equipment unless authorized officers of the parties have executed a special contract specifically governing such use. Life-critical medical equipment is medical equipment where failure of such equipment would cause serious bodily injury or death (e.g., life support, pacemakers, defibrillators, heart pumps, neurostimulators, and implantables). Such equipment includes, without limitation, all medical devices identified by the U.S. Food and Drug Administration as Class III devices and equivalent classifications outside the U.S.

TI may expressly designate certain products as completing a particular qualification (e.g., Q100, Military Grade, or Enhanced Product). Designers agree that it has the necessary expertise to select the product with the appropriate qualification designation for their applications and that proper product selection is at Designers' own risk. Designers are solely responsible for compliance with all legal and regulatory requirements in connection with such selection.

Designer will fully indemnify TI and its representatives against any damages, costs, losses, and/or liabilities arising out of Designer's non-compliance with the terms and provisions of this Notice.