

**SFH7050**  
**BioMon Sensor**  
**Version 0.2**

---

**SFH7050 BioMon**



**Draft - This design is for Reference only.**  
**Subject to change.**

**Features:**

- Multi chip package featuring 3 emitters and one detector
- Small package:  
(WxDxH) 4.7 mm x 2.5 mm x 0.9 mm
- Light Barrier to block optical crosstalk

**Besondere Merkmale:**

- Multi-Chip-Gehäuse mit 3 Emittern und einem Detektor
- Kleines Gehäuse:  
(BxTxH) 4.7 mm x 2.5 mm x 0.9 mm
- Lichtsperre zur Unterdrückung von optischem Übersprechen

**Applications**

- Heart rate monitoring
- Pulse oximetry

for:

- Wearable devices (e.g. smartwatches, fitnesstrackers, ...)
- Mobile devices

**Anwendungen**

- Herzfrequenzüberwachung
- Blutsauerstoff-Messung

für:

- Tragbare Geräte (z.B. Smartwatches, Fitnessstracker, ...)
- Mobile Geräte

**Ordering Information SFH7050 BioMon**

**Bestellinformation**

<b>Type:</b>	<b>Ordering Code</b>
<b>Typ:</b>	<b>Bestellnummer</b>
SFH7050	Q65111A6271

## Pin configuration

Pin	Name	Function
1	GC	Green LED Cathode
2	GA	Green LED Anode
3	RA	Red LED Anode
4	PA	Photodiode Anode
5	PC	Photodiode Cathode
6	RC	Red LED Cathode
7	IA	Infrared LED Anode
8	IC	Infrared LED Cathode

## Top view

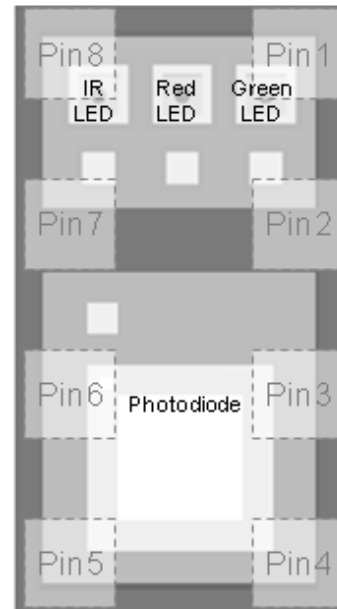

## Block diagram

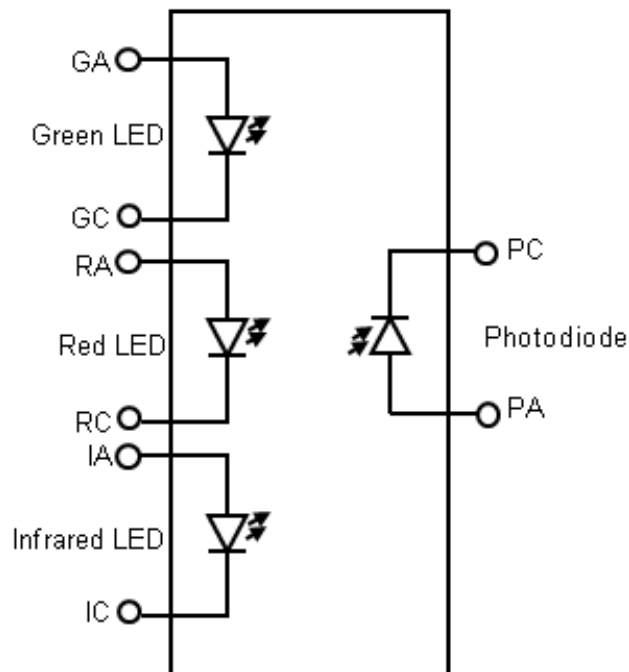

**Maximum Ratings** ( $T_A = 25\text{ °C}$ )

Parameter	Symbol	Values	Unit
<b>General</b>			
Operating temperature range	$T_{op}$	-40 ... 85	°C
Storage temperature range	$T_{stg}$	-40 ... 85	°C
ESD withstand voltage (acc. to ANSI/ ESDA/ JEDEC JS-001 - HBM)	$V_{ESD}$	2	kV
<b>Infrared Emitter</b>			
Reverse Voltage	$V_R$	5	V
Forward current	$I_{F(DC)}$	100	mA
Surge current ( $t_p = 100\ \mu s$ , $D = 0$ )	$I_{FSM}$	1	A
<b>Red Emitter</b>			
Reverse voltage	$V_R$	12	V
Forward current	$I_{F(DC)}$	70	mA
Surge current ( $t_p = 100\ \mu s$ , $D = 0$ )	$I_{FSM}$	600	mA
<b>Green Emitter</b>			
Reverse voltage	$V_R$	not designed for reverse operation	V
Forward current	$I_{F(DC)}$	50	mA
Surge current ( $t_p = 100\ \mu s$ , $D = 0$ )	$I_{FSM}$	300	mA
<b>Detector</b>			
Reverse voltage ( $I_R = 100\ \mu A$ , $E_e = 0\text{ mW/cm}^2$ )	$V_R$	16	V

Characteristics ( $T_A = 25\text{ °C}$ )

Parameter		Symbol	Value	Unit
<b>Infrared Emitter</b>				
Wavelength of peak emission ( $I_F = 20\text{ mA}$ , $t_p = 20\text{ ms}$ )	(typ.)	$\lambda_{\text{peak}}$	950	nm
Centroid Wavelength ( $I_F = 20\text{ mA}$ , $t_p = 20\text{ ms}$ )	(typ. (max.))	$\lambda_{\text{centroid}}$	940 ( $\pm 10$ )	nm
Spectral bandwidth at 50% of $I_{\text{max}}$ ( $I_F = 20\text{ mA}$ , $t_p = 20\text{ ms}$ )	(typ.)	$\Delta\lambda$	42	nm
Half angle	(typ.)	$\varphi$	$\pm 60$	$^\circ$
Rise and fall time of $I_e$ (10% and 90% of $I_{e,\text{max}}$ ) ( $I_F = 100\text{ mA}$ , $t_p = 16\text{ }\mu\text{s}$ , $R_L = 50\text{ }\Omega$ )	(typ.)	$t_r, t_f$	16	ns
Forward voltage ( $I_F = 20\text{ mA}$ , $t_p = 20\text{ ms}$ )	(typ. (max.))	$V_F$	1.3 ( $\leq 1.8$ )	V
Reverse current		$I_R$	not designed for reverse operation	$\mu\text{A}$
Radiant intensity ( $I_F = 20\text{ mA}$ , $t_p = 20\text{ ms}$ )	(typ.)	$I_e$	2	mW / sr
Total radiant flux ( $I_F = 20\text{ mA}$ , $t_p = 20\text{ ms}$ )	(typ.)	$\Phi_e$	5.3	mW
Temperature coefficient of $I_e$ or $\Phi_e$ ( $I_F = 20\text{ mA}$ , $t_p = 20\text{ ms}$ )	(typ.)	$TC_I$	-0.3	% / K
Temperature coefficient of $V_F$ ( $I_F = 20\text{ mA}$ , $t_p = 20\text{ ms}$ )	(typ.)	$TC_V$	-0.8	mV / K
Temperature coefficient of $\lambda_{\text{centroid}}$ ( $I_F = 20\text{ mA}$ , $t_p = 20\text{ ms}$ )	(typ.)	$TC_{\lambda_{\text{centroid}}}$	0.25	nm / K

Characteristics ( $T_A = 25\text{ °C}$ )

Parameter		Symbol	Value	Unit
<b>Red Emitter</b>				
Wavelength of peak emission ( $I_F = 20\text{ mA}$ )	(typ.)	$\lambda_{\text{peak}}$	660	nm
Centroid Wavelength ( $I_F = 20\text{ mA}$ )	(typ. (max.))	$\lambda_{\text{centroid}}$	655 ( $\pm 3$ )	nm
Spectral bandwidth at 50% of $I_{\text{max}}$ ( $I_F = 20\text{ mA}$ )	(typ.)	$\Delta\lambda$	17	nm
Half angle	(typ.)	$\varphi$	$\pm 60$	°
Rise and fall time of $I_e$ (10% and 90% of $I_{e\text{max}}$ ) ( $I_F = 100\text{ mA}$ , $t_p = 16\text{ }\mu\text{s}$ , $R_L = 50\text{ }\Omega$ )	(typ.)	$t_r, t_f$	17	ns
Forward voltage ( $I_F = 20\text{ mA}$ )	(typ. (max.))	$V_F$	2.1 ( $\leq 2.8$ )	V
Reverse current	(typ. (max.))	$I_R$	not designed for reverse operation	$\mu\text{A}$
Radiant intensity ( $I_F = 20\text{ mA}$ , $t_p = 20\text{ ms}$ )	(typ.)	$I_e$	2.6	mW / sr
Total radiant flux ( $I_F = 20\text{ mA}$ , $t_p = 20\text{ ms}$ )	(typ.)	$\Phi_e$	6.4	mW
Temperature coefficient of $\lambda_{\text{centroid}}$ ( $I_F = 20\text{ mA}$ , $-10\text{ °C} \leq T \leq 100\text{ °C}$ )	(typ.)	$\text{TC}_{\lambda_{\text{centroid}}}$	0.13	nm / K

Characteristics ( $T_A = 25\text{ °C}$ )

Parameter		Symbol	Value	Unit
<b>Green Emitter</b>				
Wavelength of peak emission ( $I_F = 20\text{ mA}$ )	(typ.)	$\lambda_{\text{peak}}$	525	nm
Centroid Wavelength ( $I_F = 20\text{ mA}$ )	(typ. (max.))	$\lambda_{\text{centroid}}$	530 ( $\pm 10$ )	nm
Spectral bandwidth at 50% of $I_{\text{max}}$ ( $I_F = 20\text{ mA}$ )	(typ.)	$\Delta\lambda$	34	nm
Half angle	(typ.)	$\varphi$	$\pm 60$	°
Rise and fall time of $I_e$ (10% and 90% of $I_{e\text{max}}$ ) ( $I_F = 100\text{ mA}$ , $t_p = 16\text{ }\mu\text{s}$ , $R_L = 50\text{ }\Omega$ )	(typ.)	$t_r, t_f$	32	ns
Forward voltage ( $I_F = 20\text{ mA}$ )	(typ. (max.))	$V_F$	3.4 ( $\leq 4.4$ )	V
Reverse current		$I_R$	not designed for reverse operation	$\mu\text{A}$
Radiant intensity ( $I_F = 20\text{ mA}$ , $t_p = 20\text{ ms}$ )	(typ.)	$I_e$	1.3	mW / sr
Total radiant flux ( $I_F = 20\text{ mA}$ , $t_p = 20\text{ ms}$ )	(typ.)	$\Phi_e$	2.9	mW
Temperature coefficient of $\lambda_{\text{centroid}}$ ( $I_F = 20\text{ mA}$ , $-10\text{ °C} \leq T \leq 100\text{ °C}$ )	(typ.)	$TC_{\lambda_{\text{centroid}}}$	0.03	nm / K
Temperature coefficient of $V_F$ ( $I_F = 20\text{ mA}$ , $-10\text{ °C} \leq T \leq 100\text{ °C}$ )	(typ.)	$TC_V$	-3.60	mV / K

**Characteristics** ( $T_A = 25\text{ °C}$ )

Parameter		Symbol	Value	Unit
<b>Detector</b>				
Photocurrent ( $E_e = 0.1\text{ mW/cm}^2$ , $\lambda = 530\text{ nm}$ , $V_R = 5\text{ V}$ )	(typ.)	$I_{P,530}$	0.42	$\mu\text{A}$
Photocurrent ( $E_e = 0.1\text{ mW/cm}^2$ , $\lambda = 655\text{ nm}$ , $V_R = 5\text{ V}$ )	(typ.)	$I_{P,655}$	0.76	$\mu\text{A}$
Photocurrent ( $E_e = 0.1\text{ mW/cm}^2$ , $\lambda = 940\text{ nm}$ , $V_R = 5\text{ V}$ )	(typ.)	$I_{P,940}$	1.3	$\mu\text{A}$
Wavelength of max. sensitivity	(typ.)	$\lambda_{S\text{ max}}$	920	nm
Spectral range of sensitivity	(typ.)	$\lambda_{10\%}$	400 ... 1100	nm
Radiant sensitive area	(typ.)	A	1.7	$\text{mm}^2$
Dimensions of radiant sensitive area	(typ.)	L x W	1.3 x 1.3	mm x mm
Dark current ( $V_R = 5\text{ V}$ , $E_e = 0\text{ mW/cm}^2$ )	(typ. (max.))	$I_R$	1 ( $\leq 5$ )	nA
Spectral sensitivity of the chip ( $\lambda = 530\text{ nm}$ )	(typ.)	$S_{\lambda,530}$	0.26	A / W
Spectral sensitivity of the chip ( $\lambda = 655\text{ nm}$ )	(typ.)	$S_{\lambda,655}$	0.47	A / W
Spectral sensitivity of the chip ( $\lambda = 940\text{ nm}$ )	(typ.)	$S_{\lambda,940}$	0.77	A / W
Open-circuit voltage ( $E_e = 0.1\text{ mW/cm}^2$ , $\lambda = 530\text{ nm}$ )	(typ.)	$V_{O,530}$	240	mV
Short-circuit current ( $E_e = 0.1\text{ mW/cm}^2$ , $\lambda = 530\text{ nm}$ )	(typ.)	$I_{SC,530}$	0.40	$\mu\text{A}$
Open-circuit voltage ( $E_e = 0.1\text{ mW/cm}^2$ , $\lambda = 655\text{ nm}$ )	(typ.)	$V_{O,655}$	250	mV
Short-circuit current ( $E_e = 0.1\text{ mW/cm}^2$ , $\lambda = 655\text{ nm}$ )	(typ.)	$I_{SC,655}$	0.71	$\mu\text{A}$
Open-circuit voltage ( $E_e = 0.1\text{ mW/cm}^2$ , $\lambda = 940\text{ nm}$ )	(typ.)	$V_{O,940}$	270	mV
Short-circuit current ( $E_e = 0.1\text{ mW/cm}^2$ , $\lambda = 940\text{ nm}$ )	(typ.)	$I_{SC,940}$	1.2	$\mu\text{A}$

**Characteristics** ( $T_A = 25\text{ °C}$ )

Parameter		Symbol	Value	Unit
Rise and fall time ( $V_R = 5\text{ V}$ , $R_L = 50\ \Omega$ , $\lambda = 940\text{ nm}$ )	(typ.)	$t_r$ , $t_f$	tbd.	$\mu\text{s}$
Forward voltage ( $I_F = 10\text{ mA}$ , $E = 0\text{ mW/cm}^2$ )	(typ.)	$V_F$	0.9	V
Capacitance ( $V_R = 5\text{ V}$ , $f = 1\text{ MHz}$ , $E = 0\text{ mW/cm}^2$ )	(typ.)	$C_0$	5	pF



**Diagrams for infrared emitter**

**Relative spectral emission <sup>1)</sup>**

$I_{rel} = f(\lambda)$ ,  $T_A = 25\text{ °C}$ ,  $I_F = 20\text{ mA}$

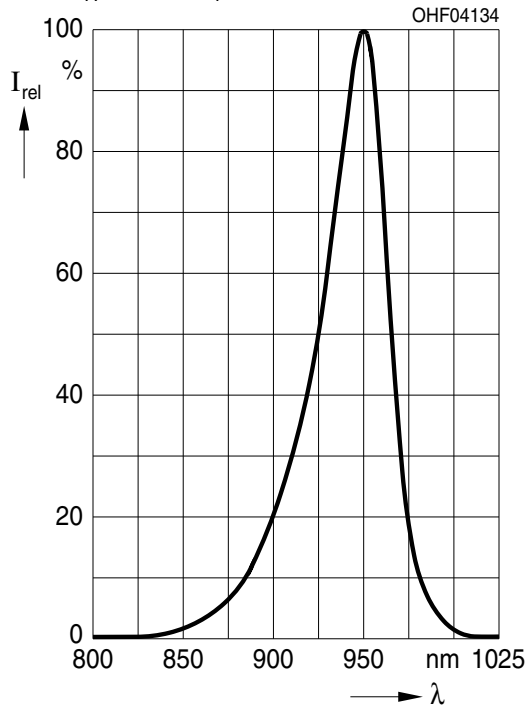

**Forward current <sup>1)</sup>**

$I_F = f(V_F)$ , single pulse,  $t_p = 100\text{ }\mu\text{s}$ ,  $T_A = 25\text{ °C}$

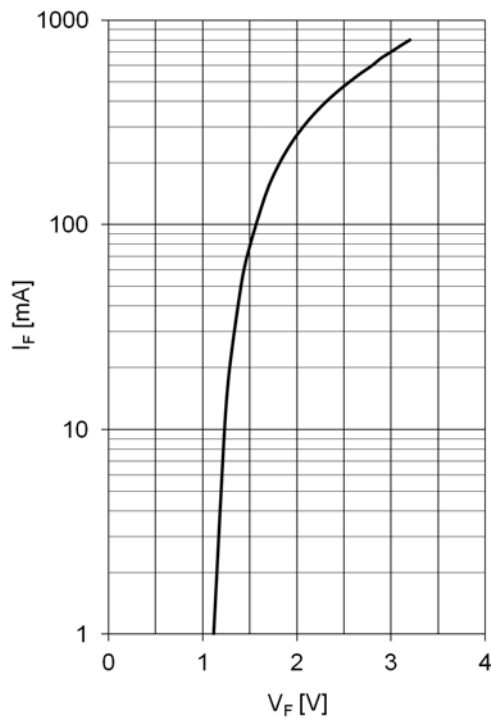

**Relative radiant flux <sup>1)</sup>**

$\Phi_e / \Phi_e(20\text{ mA}) = f(I_F)$ , single pulse,  $t_p = 25\text{ }\mu\text{s}$ ,  $T_A = 25\text{ °C}$

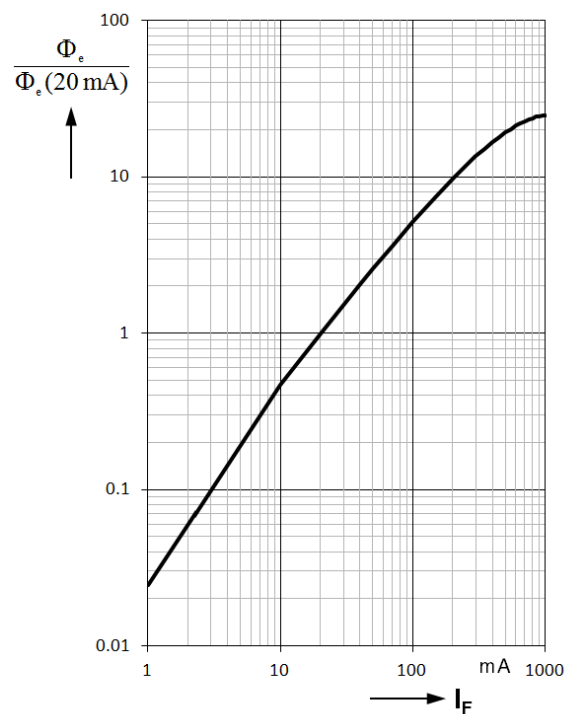

Diagrams for red emitter

Relative spectral emission <sup>1)</sup>

$I_{rel} = f(\lambda), T_A = 25\text{ }^\circ\text{C}, I_F = 20\text{ mA}$

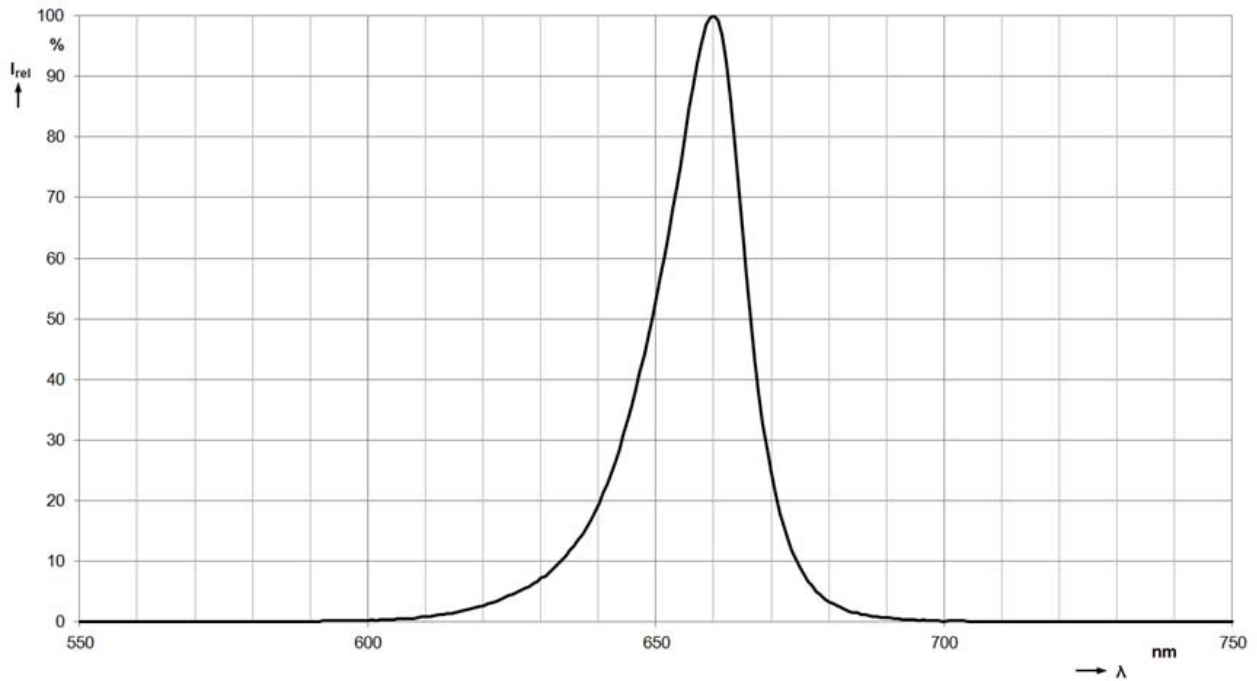

Forward current <sup>1)</sup>

$I_F = f(V_F), T_A = 25\text{ }^\circ\text{C}$

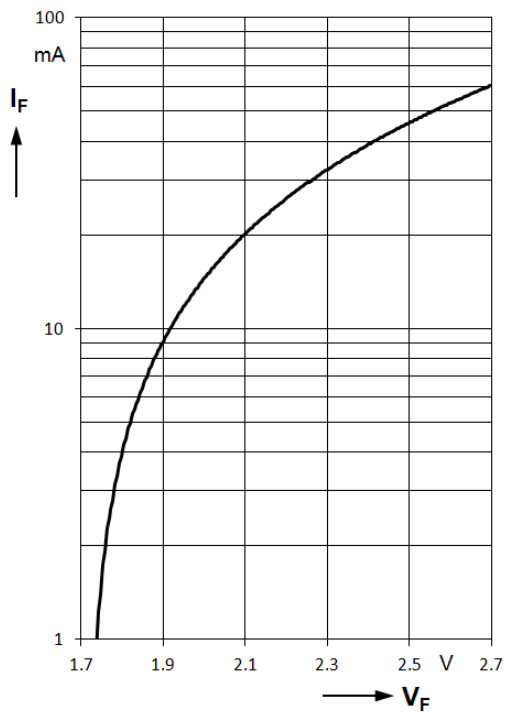

Relative radiant flux <sup>1)</sup>

$\Phi_e / \Phi_e(20\text{ mA}) = f(I_F), \text{ single pulse, } t_p = 25\mu\text{s}, T_A = 25\text{ }^\circ\text{C}$

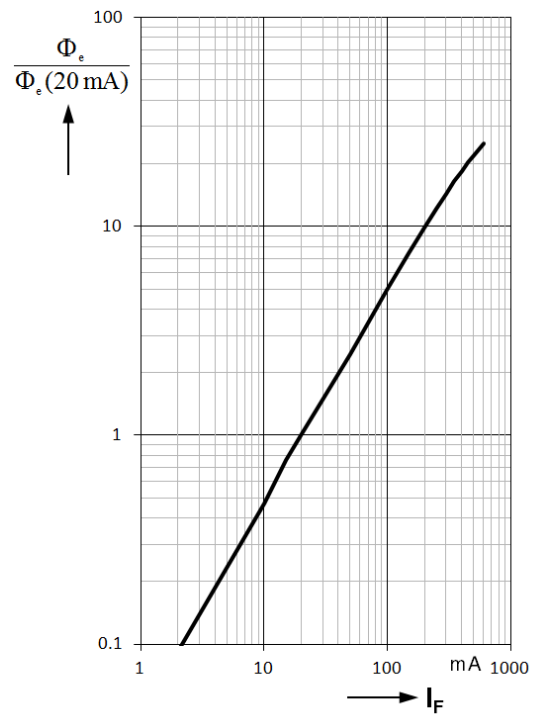

Diagrams for green emitter

Relative spectral emission <sup>1)</sup>

$I_{rel} = f(\lambda), T_A = 25\text{ }^\circ\text{C}, I_F = 20\text{ mA}$

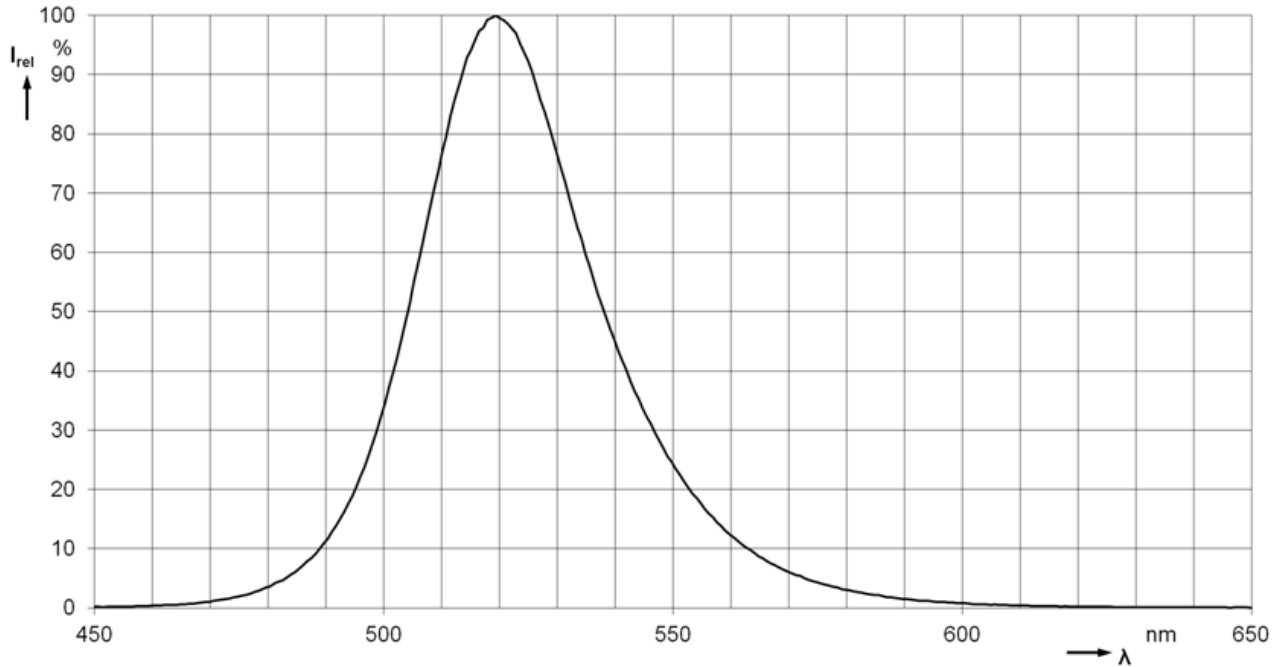

Forward current <sup>1)</sup>

$I_F = f(V_F), T_A = 25\text{ }^\circ\text{C}$

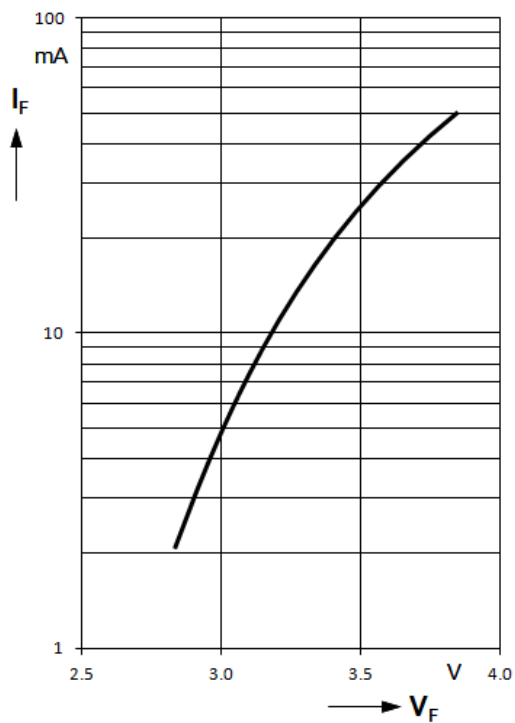

Relative radiant flux <sup>1)</sup>

$\Phi_e / \Phi_e(20\text{ mA}) = f(I_F), \text{ single pulse, } t_p = 25\mu\text{s}, T_A = 25\text{ }^\circ\text{C}$

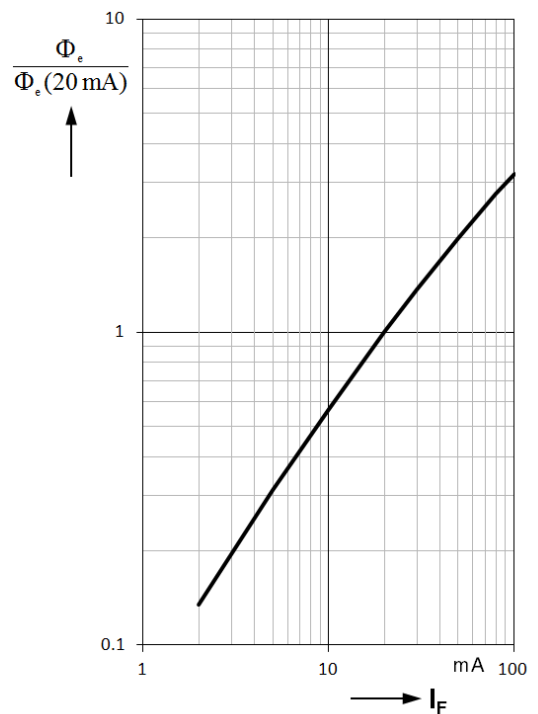

Diagrams for detector

Relative spectral sensitivity <sup>1)</sup>

$S_{rel} = f(\lambda), T_A = 25\text{ °C}$

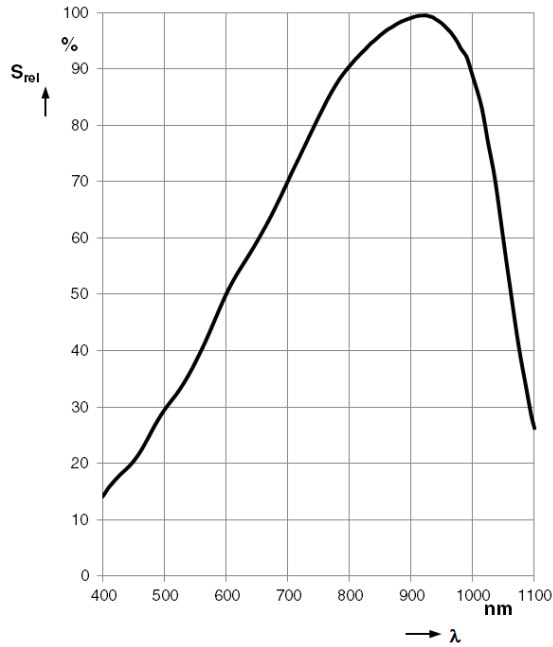

Photocurrent <sup>1)</sup>

$I_P(V_R = 5\text{ V}), T_A = 25\text{ °C}$

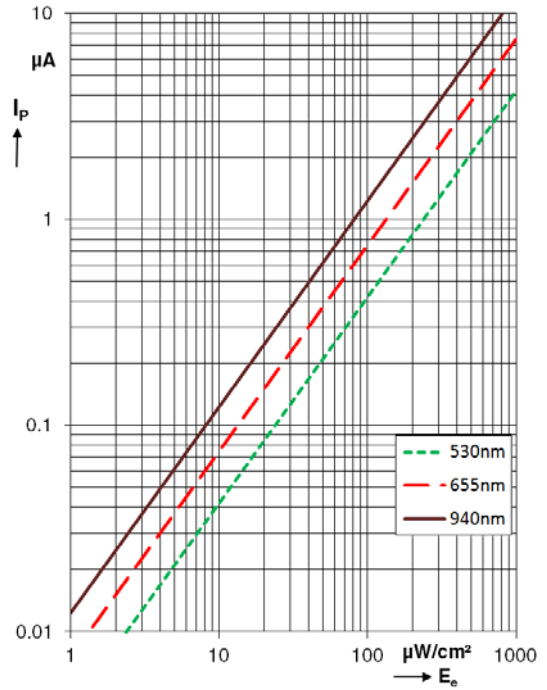

Dark current <sup>1)</sup>

$I_R = f(V_R), E = 0\text{ mW}/\text{cm}^2, T_A = 25\text{ °C}$

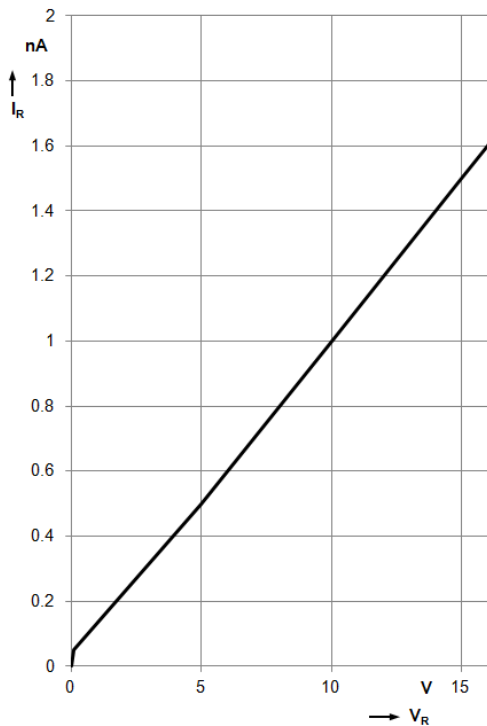

Capacitance <sup>1)</sup>

$C = f(V_R), f = 1\text{ MHz}, E = 0\text{ mW}/\text{cm}^2, T_A = 25\text{ °C}$

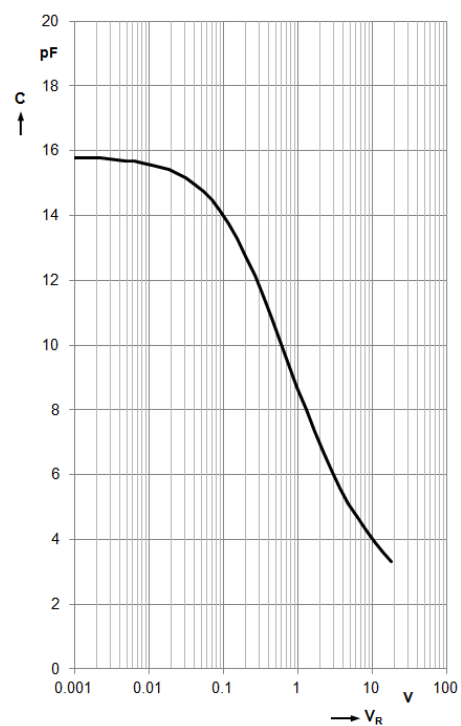

**Directional characteristics of detector <sup>1)</sup>**

$S_{rel} = f(\varphi)$

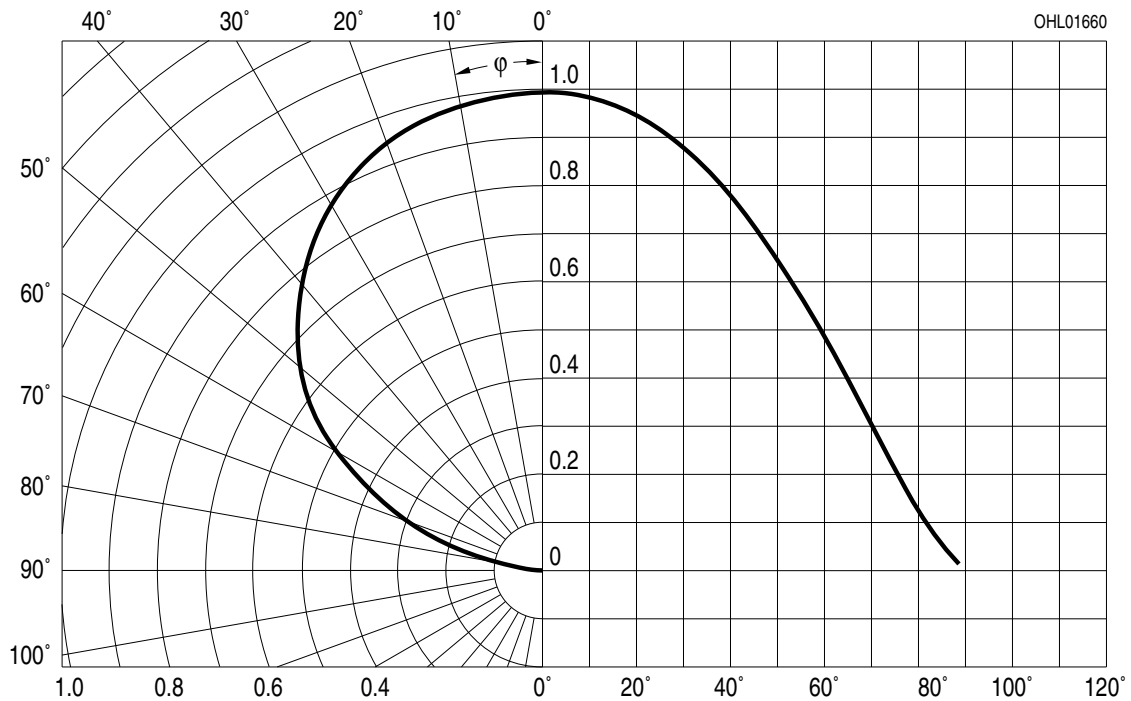

**Radiation characteristics of emitters <sup>1)</sup>**

$I_{rel} = f(\varphi)$

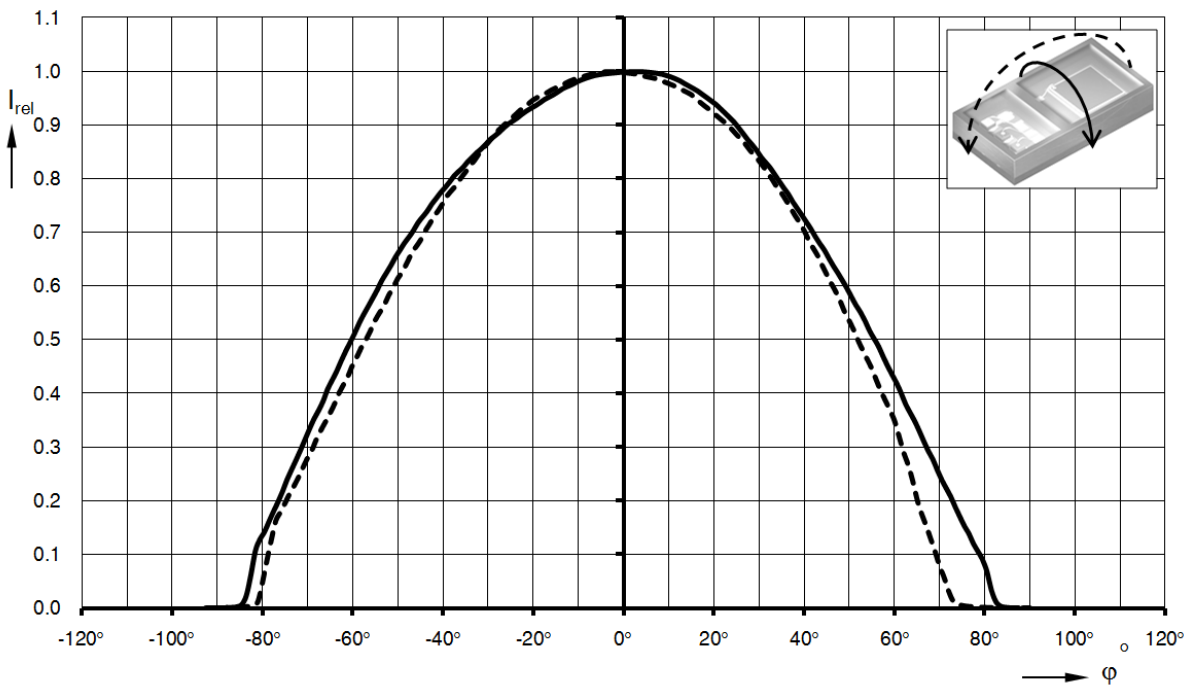

Method of Taping

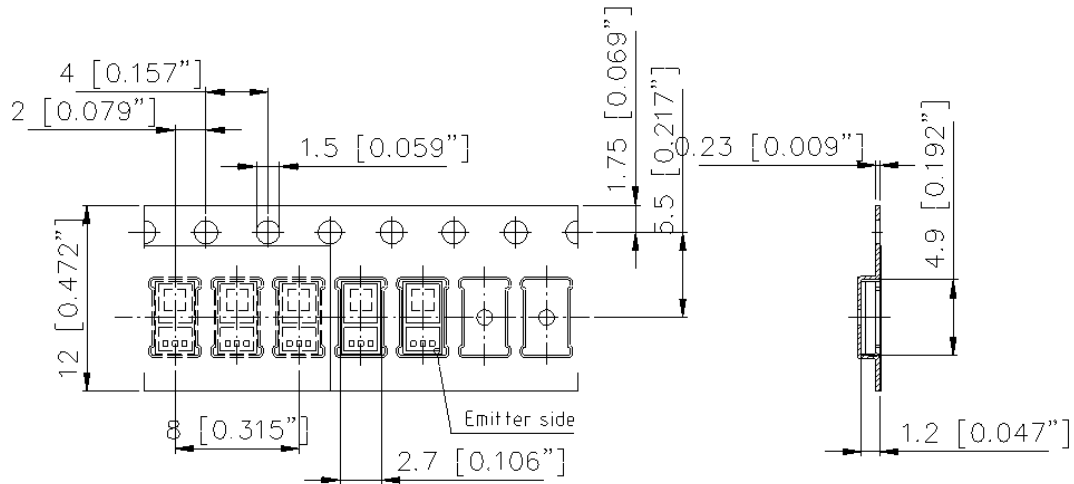

Dimensions in mm [inch]. / Maße in mm [inch].

Recommended solder pad design

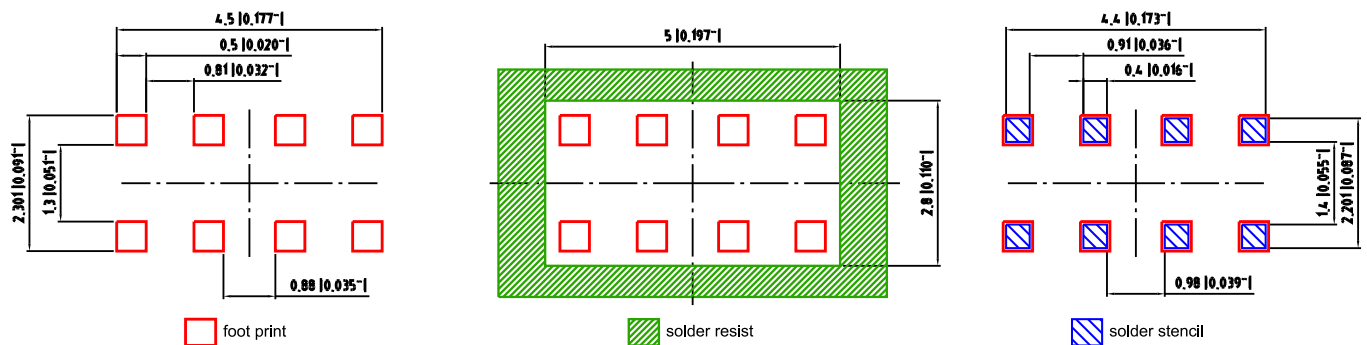

Component Location on Pad

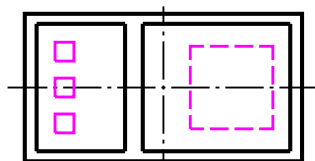

Dimensions in mm (inch). / Maße in mm (inch).

E062 3010.172-01

## Package Outline

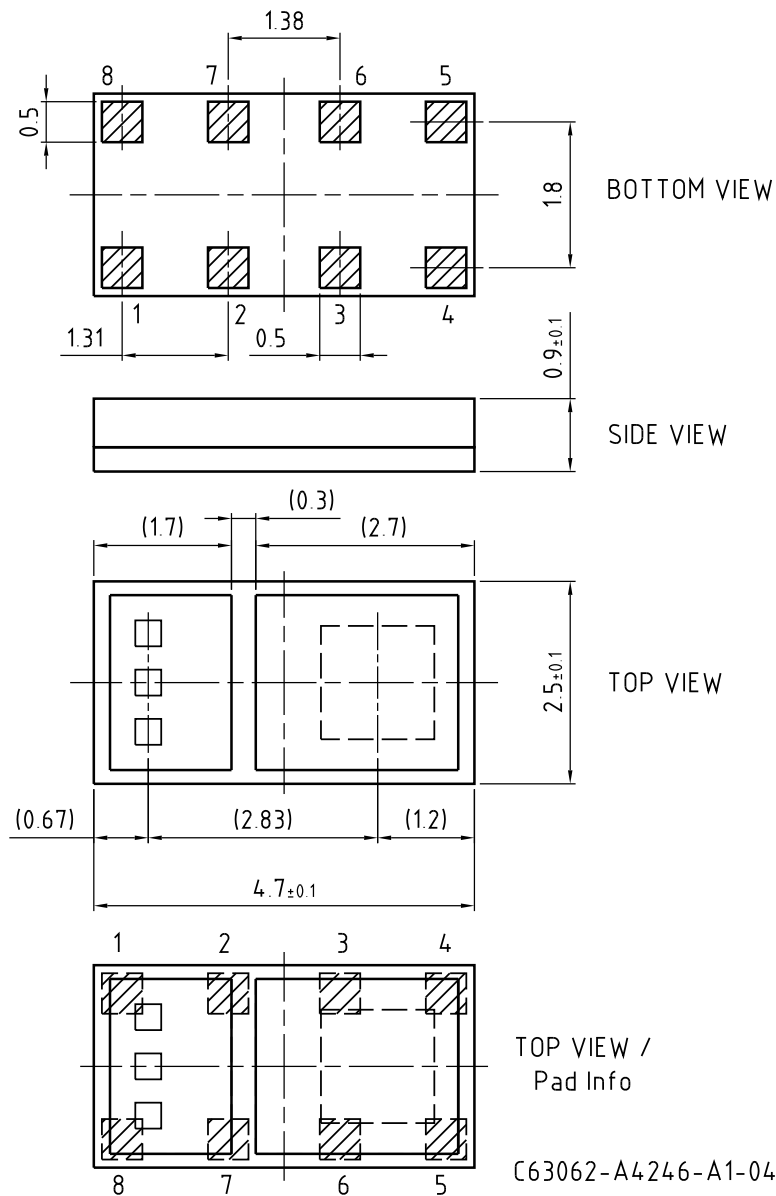

Pin1	Green LED cathode
Pin2	Green LED anode
Pin3	Red LED anode
Pin4	PD anode
Pin5	PD cathode
Pin6	Red LED cathode
Pin7	IR LED anode
Pin8	IR LED cathode

Dimensions in mm / Maße in mm.

Package: chip on board

## Reflow Soldering Profile

Product complies to MSL Level 4 acc. to JEDEC J-STD-020D.01

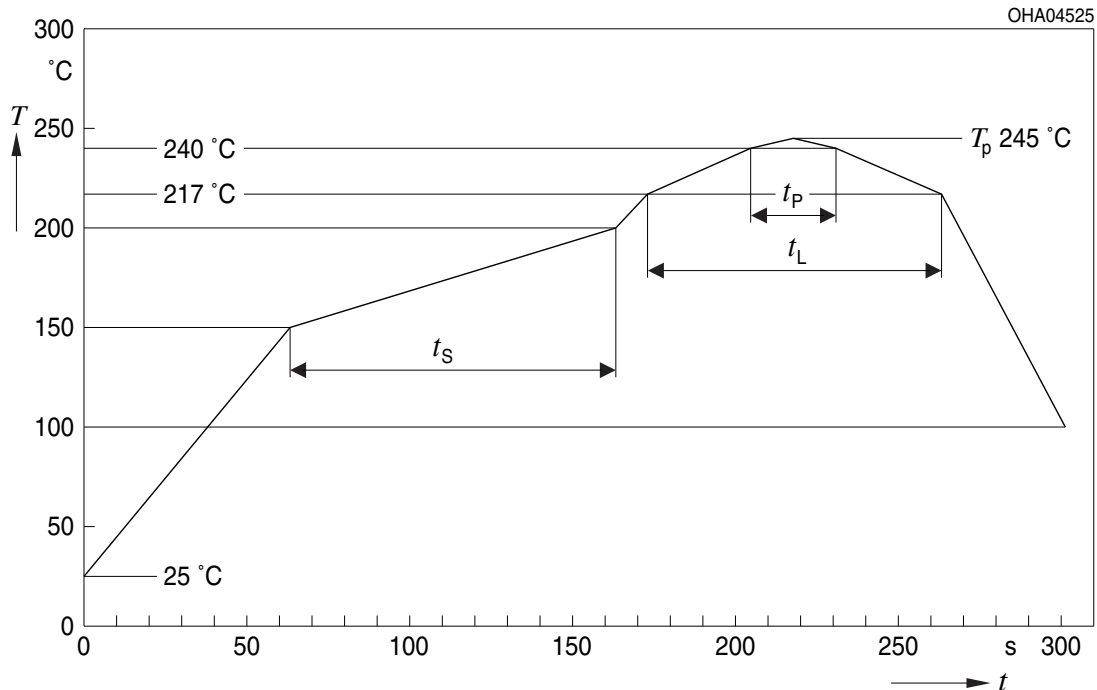

OHA04612

Profile Feature Profil-Charakteristik	Symbol Symbol	Pb-Free (SnAgCu) Assembly			Unit Einheit
		Minimum	Recommendation	Maximum	
Ramp-up rate to preheat*) 25 °C to 150 °C			2	3	K/s
Time $t_S$ $T_{Smin}$ to $T_{Smax}$	$t_S$	60	100	120	s
Ramp-up rate to peak*) $T_{Smax}$ to $T_P$			2	3	K/s
Liquidus temperature	$T_L$	217			°C
Time above liquidus temperature	$t_L$		80	100	s
Peak temperature	$T_P$		245	260	°C
Time within 5 °C of the specified peak temperature $T_P - 5$ K	$t_p$	10	20	30	s
Ramp-down rate* $T_P$ to 100 °C			3	6	K/s
Time 25 °C to $T_P$				480	s

All temperatures refer to the center of the package, measured on the top of the component

\* slope calculation  $DT/Dt$ :  $Dt$  max. 5 s; fulfillment for the whole T-range



### Disclaimer

OSRAM OS assumes no liability whatsoever for any use of this document or its content by recipient including, but not limited to, for any design in activities based on this preliminary draft version. OSRAM OS may e.g. decide at its sole discretion to stop developing and/or finalizing the underlying design at any time.

### Attention please!

The information describes the type of component and shall not be considered as assured characteristics.

Terms of delivery and rights to change design reserved.

Due to technical requirements components may contain dangerous substances.

For information on the types in question please contact our Sales Organization. If printed or downloaded, please find the latest version in the Internet.

### Packing

Please use the recycling operators known to you. We can also help you – get in touch with your nearest sales office. By agreement we will take packing material back, if it is sorted. You must bear the costs of transport.

For packing material that is returned to us unsorted or which we are not obliged to accept, we shall have to invoice you for any costs incurred.

### Components used in life-support devices or systems must be expressly authorized for such purpose!

Critical components\* may only be used in life-support devices\*\* or systems with the express written approval of OSRAM OS.

\*) A critical component is a component used in a life-support device or system whose failure can reasonably be expected to cause the failure of that life-support device or system, or to affect its safety or the effectiveness of that device or system.

\*\*) Life support devices or systems are intended (a) to be implanted in the human body, or (b) to support and/or maintain and sustain human life. If they fail, it is reasonable to assume that the health and the life of the user may be endangered.

### Disclaimer

OSRAM OS übernimmt keine wie auch immer geartete Haftung für die Nutzung dieses Dokuments und seines Inhaltes durch den Empfänger, insbesondere nicht für irgendwelche Design-Aktivitäten, die auf dieser vorläufigen Entwurfsversion basieren. OSRAM OS behält sich beispielsweise auch vor, jederzeit die Weiter- und Fertigentwicklung des zugrundeliegenden Designs einseitig einzustellen.

### Bitte beachten!

Lieferbedingungen und Änderungen im Design vorbehalten. Aufgrund technischer Anforderungen können die Bauteile Gefahrstoffe enthalten. Für weitere Informationen zu gewünschten Bauteilen, wenden Sie sich bitte an unseren Vertrieb. Falls Sie dieses Datenblatt ausgedruckt oder heruntergeladen haben, finden Sie die aktuellste Version im Internet.

### Verpackung

Benutzen Sie bitte die Ihnen bekannten Recyclingwege. Wenn diese nicht bekannt sein sollten, wenden Sie sich bitte an das nächstgelegene Vertriebsbüro. Wir nehmen das Verpackungsmaterial zurück, falls dies vereinbart wurde und das Material sortiert ist. Sie tragen die Transportkosten. Für Verpackungsmaterial, das unsortiert an uns zurückgeschickt wird oder das wir nicht annehmen müssen, stellen wir Ihnen die anfallenden Kosten in Rechnung.

### Bauteile, die in lebenserhaltenden Apparaten und Systemen eingesetzt werden, müssen für diese Zwecke ausdrücklich zugelassen sein!

Kritische Bauteile\* dürfen in lebenserhaltenden Apparaten und Systemen\*\* nur dann eingesetzt werden, wenn ein schriftliches Einverständnis von OSRAM OS vorliegt.

\*) Ein kritisches Bauteil ist ein Bauteil, das in lebenserhaltenden Apparaten oder Systemen eingesetzt wird und dessen Defekt voraussichtlich zu einer Fehlfunktion dieses lebenserhaltenden Apparates oder Systems führen wird oder die Sicherheit oder Effektivität dieses Apparates oder Systems beeinträchtigt.

\*\*) Lebenserhaltende Apparate oder Systeme sind für (a) die Implantierung in den menschlichen Körper oder (b) für die Lebenserhaltung bestimmt. Falls Sie versagen, kann davon ausgegangen werden, dass die Gesundheit und das Leben des Patienten in Gefahr ist.

## Glossary

<sup>1)</sup> **Typical Values:** Due to the special conditions of the manufacturing processes of LED and photodiodes, the typical data or calculated correlations of technical parameters can only reflect statistical figures. These do not necessarily correspond to the actual parameters of each single product, which could differ from the typical data and calculated correlations or the typical characteristic line. If requested, e.g. because of technical improvements, these typ. data will be changed without any further notice.

## Glossar

<sup>1)</sup> **Typische Werte:** Wegen der besonderen Prozessbedingungen bei der Herstellung von LED und Photodioden können typische oder abgeleitete technische Parameter nur aufgrund statistischer Werte wiedergegeben werden. Diese stimmen nicht notwendigerweise mit den Werten jedes einzelnen Produktes überein, dessen Werte sich von typischen und abgeleiteten Werten oder typischen Kennlinien unterscheiden können. Falls erforderlich, z.B. aufgrund technischer Verbesserungen, werden diese typischen Werte ohne weitere Ankündigung geändert.

Published by OSRAM Opto Semiconductors GmbH  
Leibnizstraße 4, D-93055 Regensburg  
www.osram-os.com © All Rights Reserved.

EU RoHS and China RoHS compliant product



此产品符合欧盟 RoHS 指令的要求；

按照中国的相关法规和标准，不含有毒有害物质或元素。

# Mouser Electronics

Authorized Distributor

Click to View Pricing, Inventory, Delivery & Lifecycle Information:

[Osram Opto Semiconductor:](#)

[SFH 7050](#)