



## Optocoupler, Photodarlington Output (Single, Dual, Quad Channel)

### Features

- 125 mA Load Current Rating
- Fast Rise Time, 10  $\mu$ s
- Fast Fall Time, 35  $\mu$ s
- Single, Dual and Quad Channel
- Solid State Reliability
- Standard DIP Packages
- Lead-free component
- Component in accordance to RoHS 2002/95/EC and WEEE 2002/96/EC

### Agency Approvals

- UL1577, File No. E52744 System Code H or J, Double Protection
- DIN EN 60747-5-2 (VDE0884)  
DIN EN 60747-5-5 pending  
Available with Option 1
- BSI IEC60950 IEC60065
- FIMKO

### Description

The IL30/ IL31/ IL55 single, ILD30/ ILD31/ ILD55 dual, and ILQ30/ ILQ31/ ILQ55 quad are optically coupled isolators with Gallium Arsenide infrared emitters and silicon photodarlington sensors. Switching can be achieved while maintaining a high degree of isolation between driving and load circuits, with no crosstalk between channels. These optocouplers can be used to replace reed and mercury relays with advantages of long life, high speed switching and elimination of magnetic fields.

The IL30/ IL31/ IL55 are equivalent to MCA230/ MCA231/ MCA255. The ILD30/ ILD31/ ILD55 are designed to reduce board space requirements in high density applications.

Single Channel

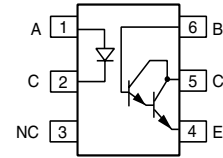
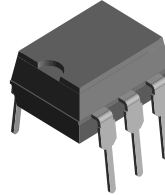

Dual Channel

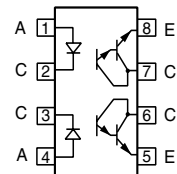
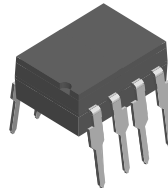

Quad Channel

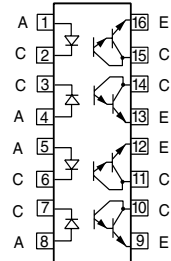
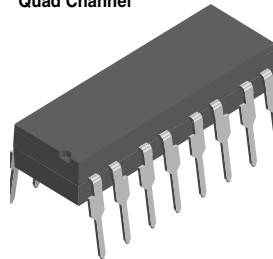

1179011



### Order Information

| Part       | Remarks                                      |
|------------|--|
| IL30       | CTR > 100 %, Single Channel DIP-6            |
| IL31       | CTR > 200 %, Single Channel DIP-6            |
| IL55       | CTR > 100 %, Single Channel DIP-6            |
| ILD30      | CTR > 100 %, Dual Channel DIP-8              |
| ILD31      | CTR > 200 %, Dual Channel DIP-8              |
| ILD55      | CTR > 100 %, Dual Channel DIP-8              |
| ILQ30      | CTR > 100 %, Quad Channel DIP-16             |
| ILQ31      | CTR > 200 %, Quad Channel DIP-16             |
| ILQ55      | CTR > 100 %, Quad Channel DIP-16             |
| IL55-X009  | CTR > 100 %, Single Channel SMD-6 (option 9) |
| ILD30-X009 | CTR > 100 %, Dual Channel SMD-8 (option 9)   |
| ILD31-X007 | CTR > 200 %, Dual Channel SMD-8 (option 7)   |
| ILD31-X009 | CTR > 200 %, Dual Channel SMD-8 (option 9)   |
| ILD55-X007 | CTR > 100 %, Dual Channel SMD-8 (option 7)   |
| ILD55-X009 | CTR > 100 %, Dual Channel SMD-8 (option 9)   |
| ILQ30-X009 | CTR > 100 %, Quad Channel SMD-16 (option 9)  |
| ILQ55-X007 | CTR > 100 %, Quad Channel SMD-16 (option 7)  |
| ILQ55-X009 | CTR > 100 %, Quad Channel SMD-16 (option 9)  |

For additional information on the available options refer to Option Information.

### Absolute Maximum Ratings

$T_{amb} = 25\text{ }^{\circ}\text{C}$ , unless otherwise specified

Stresses in excess of the absolute Maximum Ratings can cause permanent damage to the device. Functional operation of the device is not implied at these or any other conditions in excess of those given in the operational sections of this document. Exposure to absolute Maximum Rating for extended periods of the time can adversely affect reliability.

### Input

(each channel)

| Parameter                  | Test condition | Symbol     | Value | Unit  |
|----------------------------|----------------|------------|-------|-------|
| Peak reverse voltage       |                | $V_{RM}$   | 3.0   | V     |
| Forward continuous current |                | $I_F$      | 60    | mA    |
| Power dissipation          |                | $P_{diss}$ | 100   | mW    |
| Derate linearly from 25 °C |                |            | 1.33  | mW/°C |

### Output

| Parameter                           | Test condition | Part  | Symbol     | Value | Unit |
|-------------------------------------|----------------|-------|------------|-------|------|
| Collector-emitter breakdown voltage |                | IL30  | $BV_{CEO}$ | 30    | V    |
|                                     |                | ILD30 | $BV_{CEO}$ | 30    | V    |
|                                     |                | ILQ30 | $BV_{CEO}$ | 30    | V    |
|                                     |                | IL55  | $BV_{CEO}$ | 55    | V    |
|                                     |                | ILD55 | $BV_{CEO}$ | 55    | V    |
|                                     |                | ILD55 | $BV_{CEO}$ | 55    | V    |



| Parameter                  | Test condition | Part | Symbol     | Value | Unit  |
|----------------------------|----------------|------|------------|-------|-------|
| Collector (load) current   |                |      | $I_C$      | 125   | mA    |
| Power dissipation          |                |      | $P_{diss}$ | 150   | mW    |
| Derate linearly from 25 °C |                |      |            | 2.0   | mW/°C |

## Coupler

| Parameter                       | Test condition | Part  | Symbol    | Value         | Unit      |
|---------------------------------|----------------|-------|-----------|---------------|-----------|
| Total package power dissipation |                | IL30  | $P_{tot}$ | 250           | mW        |
|                                 |                | IL31  | $P_{tot}$ | 250           | mW        |
|                                 |                | IL55  | $P_{tot}$ | 250           | mW        |
|                                 |                | ILD30 | $P_{tot}$ | 400           | mW        |
|                                 |                | ILD31 | $P_{tot}$ | 400           | mW        |
|                                 |                | ILD55 | $P_{tot}$ | 400           | mW        |
|                                 |                | ILQ30 | $P_{tot}$ | 500           | mW        |
|                                 |                | ILQ31 | $P_{tot}$ | 500           | mW        |
|                                 |                | ILQ55 | $P_{tot}$ | 500           | mW        |
| Derate linearly from 25 °C      |                | IL30  |           | 3.3           | mW/°C     |
|                                 |                | IL31  |           | 3.3           | mW/°C     |
|                                 |                | IL55  |           | 3.3           | mW/°C     |
|                                 |                | ILD30 |           | 5.33          | mW/°C     |
|                                 |                | ILD31 |           | 5.33          | mW/°C     |
|                                 |                | ILD55 |           | 5.33          | mW/°C     |
|                                 |                | ILQ30 |           | 6.67          | mW/°C     |
|                                 |                | ILQ31 |           | 6.67          | mW/°C     |
|                                 |                | ILQ55 |           | 6.67          | mW/°C     |
| Isolation test voltage          |                |       | $V_{ISO}$ | 5300          | $V_{RMS}$ |
| Creepage                        |                |       |           | ≥ 7.0         | mm        |
| Clearance                       |                |       |           | ≥ 7.0         | mm        |
| Comparative tracking index      |                |       |           | 175           |           |
| Storage temperature             |                |       | $T_{stg}$ | - 55 to + 125 | °C        |
| Operating temperature           |                |       | $T_{amb}$ | - 55 to + 100 | °C        |
| Lead soldering time at 260 °C   |                |       |           | 10            | sec.      |

## Electrical Characteristics

$T_{amb} = 25\text{ °C}$ , unless otherwise specified

Minimum and maximum values are testing requirements. Typical values are characteristics of the device and are the result of engineering evaluation. Typical values are for information only and are not part of the testing requirements.

## Input

GaAs emitter (per channel)

| Parameter       | Test condition       | Symbol | Min | Typ. | Max | Unit |
|-----------------|----------------------|--------|-----|------|-----|------|
| Forward voltage | $I_F = 20\text{ mA}$ | $V_F$  |     | 1.25 | 1.5 | V    |
| Reverse current | $V_R = 3.0\text{ V}$ | $I_R$  |     | 0.1  | 10  | μA   |
| Capacitance     | $V_R = 0\text{ V}$   | $C_O$  |     | 25   |     | pF   |

### Output

per channel

| Parameter                           | Test condition                               | Symbol     | Min   | Typ. | Max | Unit |
|-------------------------------------|--|------------|-------|------|-----|------|
| Collector-emitter breakdown voltage | $I_C = 100 \mu\text{A}$                      | $BV_{CEO}$ | 30/55 |      |     | V    |
| Collector-emitter leakage current   | $V_{CE} = 10 \text{ V}, I_F = 0$             | $I_{CEO}$  |       | 1.0  | 100 | nA   |
| Collector-emitter capacitance       | $V_{CE} = 10 \text{ V}, f = 1.0 \text{ MHz}$ | $C_{CE}$   |       | 3.4  |     | pF   |

### Coupler

| Parameter                            | Test condition                             | Symbol      | Min  | Typ.      | Max | Unit      |
|--------------------------------------|--|-------------|------|-----------|-----|-----------|
| Collector-emitter saturation voltage | $I_C = 50 \text{ mA}, I_F = 50 \text{ mA}$ | $V_{CEsat}$ |      | 0.9       | 1.0 | V         |
| Isolation test voltage               |  |             | 5300 |           |     | $V_{RMS}$ |
| Isolation resistance                 |  | $R_{IO}$    |      | $10^{12}$ |     | $\Omega$  |
| Capacitance (input-output)           |  | $C_{IO}$    |      | 0.5       |     | pF        |

### Current Transfer Ratio

| Parameter              | Test condition                                | Part  | Symbol | Min | Typ. | Max | Unit |
|------------------------|---|-------|--------|-----|------|-----|------|
| Current Transfer Ratio | $I_F = 10 \text{ mA}, V_{CE} = 5.0 \text{ V}$ | IL30  | CTR    | 100 | 400  |     | %    |
|                        |   | IL55  | CTR    | 100 | 400  |     | %    |
|                        |   | ILD30 | CTR    | 100 | 400  |     | %    |
|                        |   | ILD55 | CTR    | 100 | 400  |     | %    |
|                        |   | ILQ30 | CTR    | 100 | 400  |     | %    |
|                        |   | ILQ55 | CTR    | 100 | 400  |     | %    |
|                        |   | IL31  | CTR    | 200 | 400  |     | %    |
|                        |   | ILD31 | CTR    | 200 | 400  |     | %    |
| ILQ31                  | CTR   | 200   | 400    |     | %    |     |      |



## Switching Characteristics

| Parameter | Test condition  | Symbol | Min | Typ. | Max | Unit          |
|-----------|---|--------|-----|------|-----|---------------|
| Rise time | $V_{CC} = 13.5\text{ V}$ , $I_F = 50\text{ mA}$ , $R_L = 100\ \Omega$ | $t_r$  |     | 10   |     | $\mu\text{s}$ |
| Fall time | $V_{CC} = 13.5\text{ V}$ , $I_F = 50\text{ mA}$ , $R_L = 100\ \Omega$ | $t_f$  |     | 35   |     | $\mu\text{s}$ |

## Typical Characteristics ( $T_{amb} = 25\text{ }^\circ\text{C}$ unless otherwise specified)

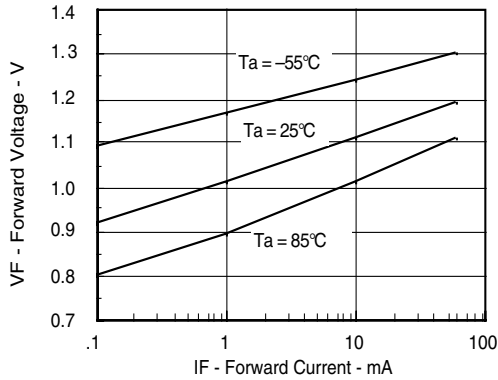

830\_01

Figure 1. Forward Voltage vs. Forward Current

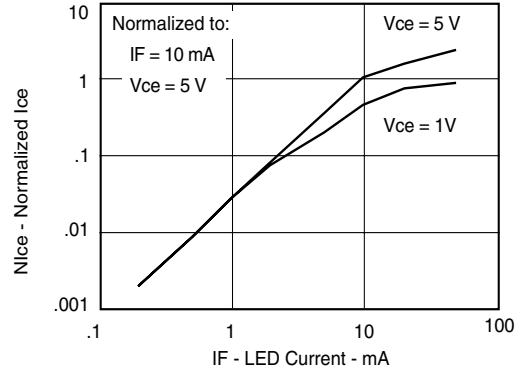

830\_03

Figure 3. Normalized Non-Saturated and Saturated Collector-Emitter Current vs. LED Current

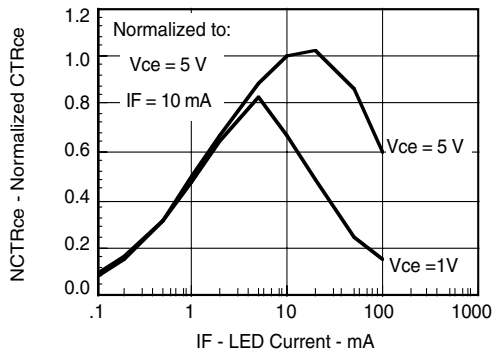

830\_02

Figure 2. Normalized Non-Saturated and Saturated  $CTR_{CE}$  vs. LED Current

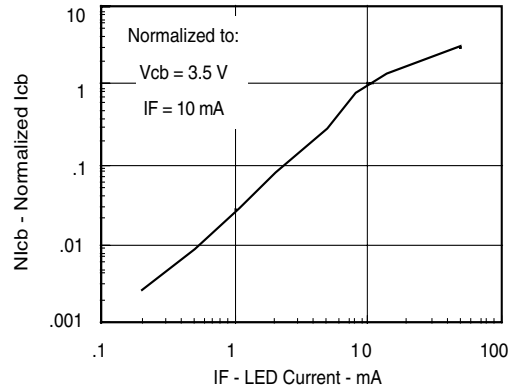

830\_04

Figure 4. Normalized Collector-Base Photocurrent vs. LED Current

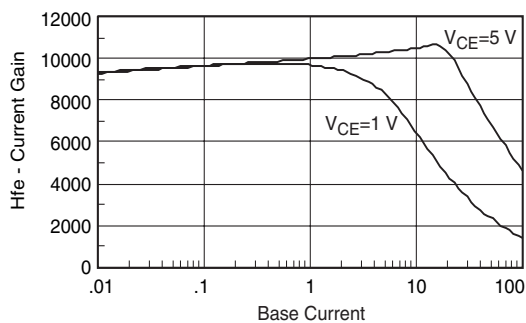

#30\_05

Figure 5. HFE Current Gain vs. Base Current

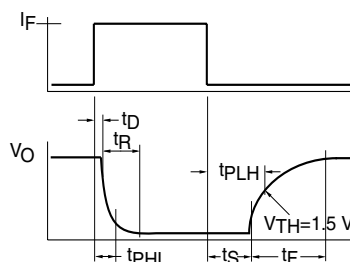

#30\_08

Figure 8. Switching Waveform

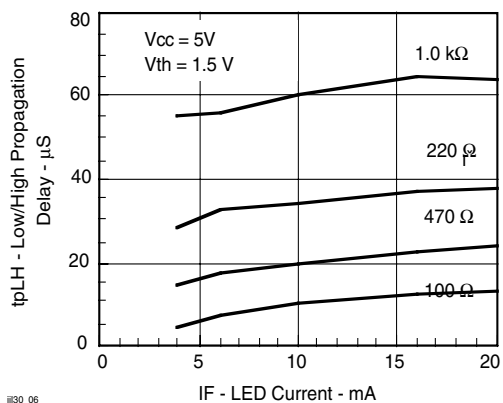

#30\_06

Figure 6. Low to High Propagation Delay vs. Collector Load Resistance and LED Current

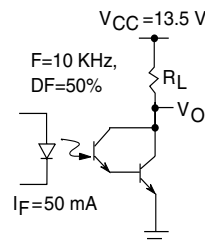

#30\_09

Figure 9. Switching Schematic

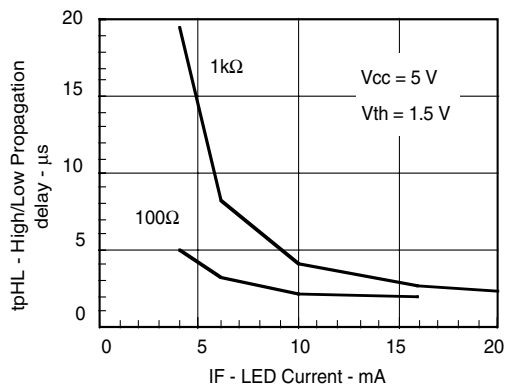

#30\_07

Figure 7. High to low Propagation Delay vs. Collector Load Resistance and LED Current



# IL30/ 31/ 55/ ILD30/ 31/ 55/ ILQ30/ 31/ 55

Vishay Semiconductors

## Package Dimensions in Inches (mm)

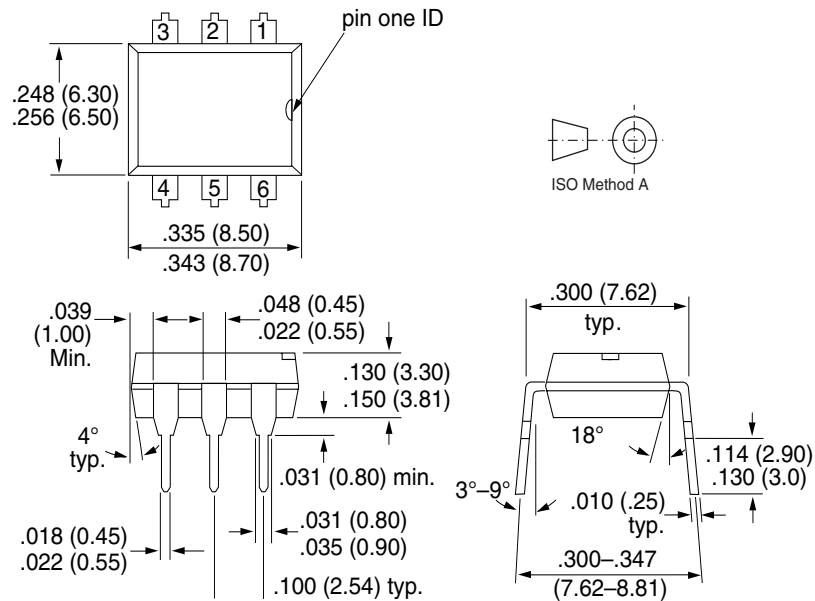

i178004

## Package Dimensions in Inches (mm)

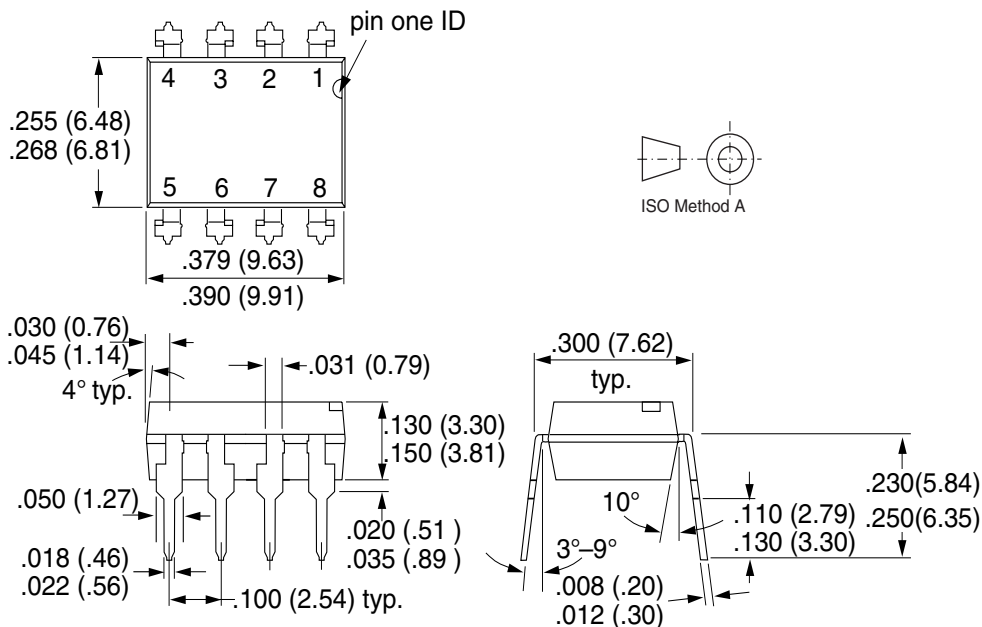

i178006

# IL30/ 31/ 55/ ILD30/ 31/ 55/ ILQ30/ 31/ 55



Vishay Semiconductors

## Package Dimensions in Inches (mm)

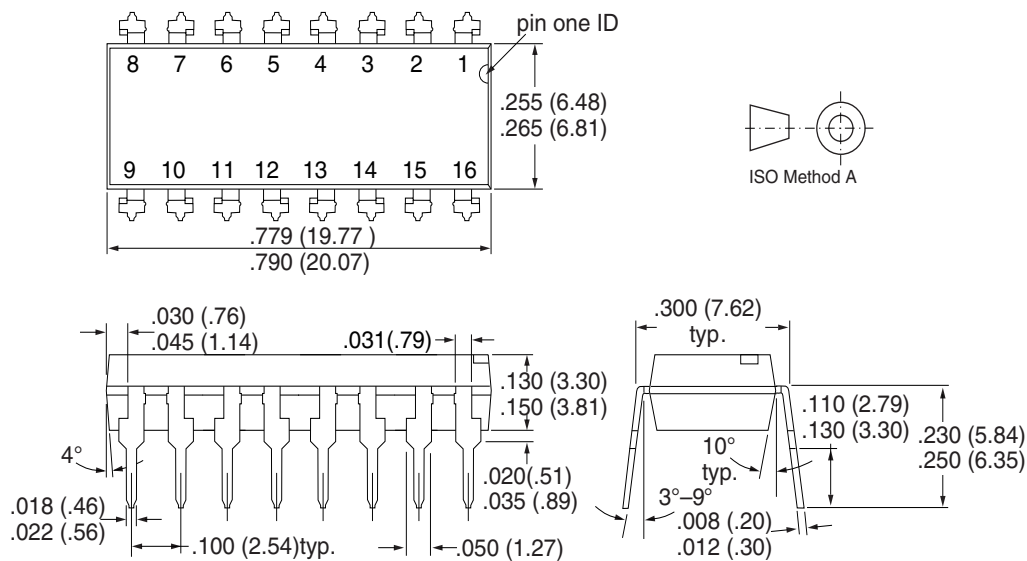

i178007

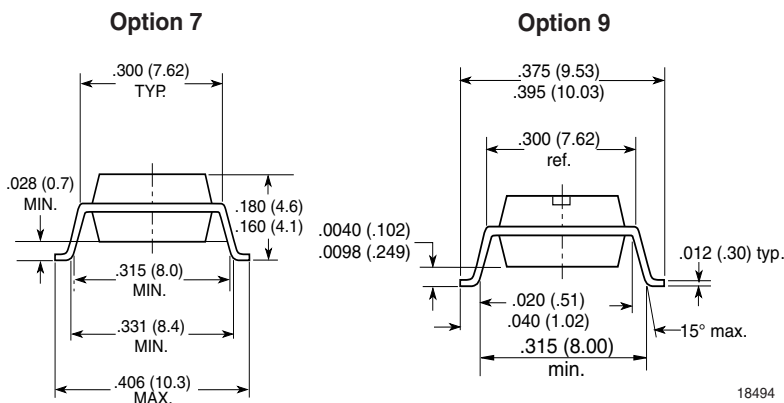





## Ozone Depleting Substances Policy Statement

It is the policy of Vishay Semiconductor GmbH to

1. Meet all present and future national and international statutory requirements.
2. Regularly and continuously improve the performance of our products, processes, distribution and operating systems with respect to their impact on the health and safety of our employees and the public, as well as their impact on the environment.

It is particular concern to control or eliminate releases of those substances into the atmosphere which are known as ozone depleting substances (ODSs).

The Montreal Protocol (1987) and its London Amendments (1990) intend to severely restrict the use of ODSs and forbid their use within the next ten years. Various national and international initiatives are pressing for an earlier ban on these substances.

Vishay Semiconductor GmbH has been able to use its policy of continuous improvements to eliminate the use of ODSs listed in the following documents.

1. Annex A, B and list of transitional substances of the Montreal Protocol and the London Amendments respectively
2. Class I and II ozone depleting substances in the Clean Air Act Amendments of 1990 by the Environmental Protection Agency (EPA) in the USA
3. Council Decision 88/540/EEC and 91/690/EEC Annex A, B and C (transitional substances) respectively.

Vishay Semiconductor GmbH can certify that our semiconductors are not manufactured with ozone depleting substances and do not contain such substances.

We reserve the right to make changes to improve technical design and may do so without further notice.

Parameters can vary in different applications. All operating parameters must be validated for each customer application by the customer. Should the buyer use Vishay Semiconductors products for any unintended or unauthorized application, the buyer shall indemnify Vishay Semiconductors against all claims, costs, damages, and expenses, arising out of, directly or indirectly, any claim of personal damage, injury or death associated with such unintended or unauthorized use.

Vishay Semiconductor GmbH, P.O.B. 3535, D-74025 Heilbronn, Germany  
Telephone: 49 (0)7131 67 2831, Fax number: 49 (0)7131 67 2423