

Pro-face
for the best interface

HMI Screen Editor & Logic Programming Software
GP-Pro EX

HVS
PRECONISATEUR DE SOLUTIONS DEPUIS 1986

2 rue René Laennec 51500 Taissy France
Fax: 03 26 85 19 08, Tel : 03 26 82 49 29

E-mail: hvssystem@hvssystem.com
Site web : www.hvssystem.com

GP-Pro EX Ver. 3.0

HMI Screen Editor & Logic Programming Software

Easy to Use

Supports the new **GP4000** Series



New Products Introducing

Easy creation of easy-to-read screens

Design sample parts can be downloaded and used immediately.

3D Real Parts

Add three-dimensional graphical real parts and easily create easy-to-read screens with high added value.

Meters Production equipment measurements and temperatures are intuitively displayed.



Switches/Lamps Can be visually checked like real switches and lamps. It increases the added value of your screens.

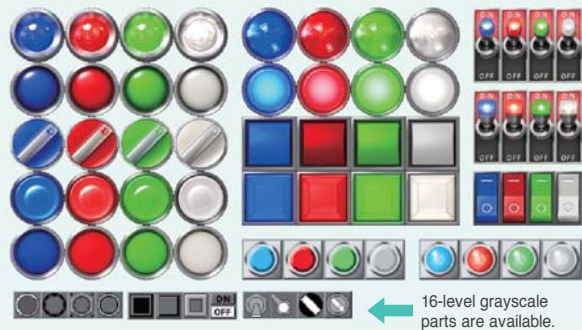

16-level grayscale parts are available.

Bitmaps and other formats can be used



Extensive samples

Finished sample parts are available on the web!

Parts Samples Easily add part samples on existing screens.

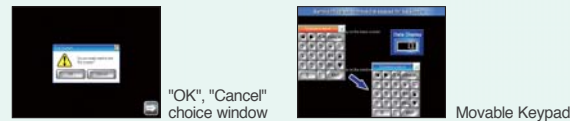

Screen Samples Reduce screen development time with the samples.



Feature Samples High-functionality samples with a combination of multiple functions and scripts.

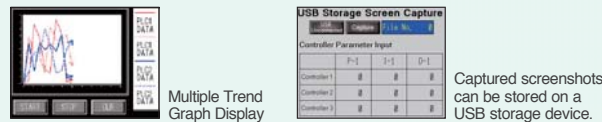

Captured screenshots can be stored on a USB storage device.

Connected Device Samples Simplify complex control settings for controllers and inverters with these defined samples.

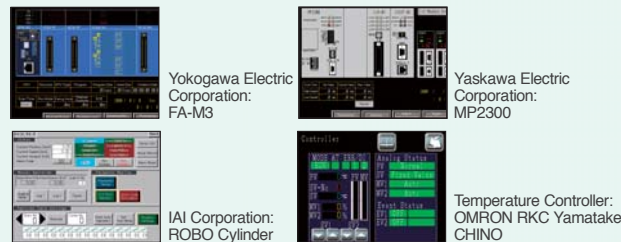

More samples of temperature controllers and inverters of various manufacturers are available.

PLC Connected Test Samples

You can download PLC programs with preset communication settings and GP screen data.

For details on features and supported models, please go to our website of software product page.
<http://www.pro-face.com/product/soft/gpproex/>

Download sample parts for FREE!

Sample parts can be downloaded for free to meet various needs in creating screens. Repair and other support services are also available.

More support content available. Access the site below.
<http://www.pro-face.com/otasuke/>



Easy creation of elaborate screens

Alarm Analysis

When an error occurs, an operator can easily seek and check the condition on-site, just by touching the alarm message to call up various error-related data in chronological order.

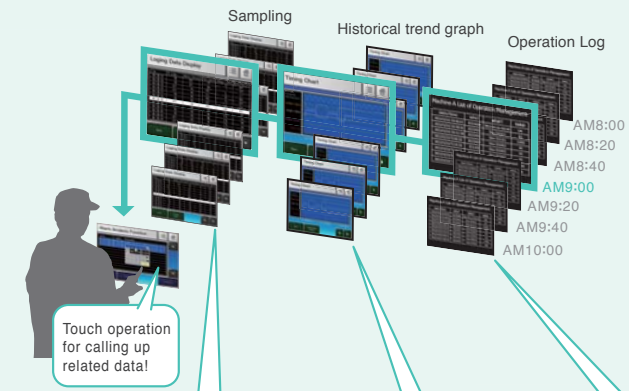

Storing various data during production

Sampling data

Temperature, voltage, and other desired address values can be stored in the GP. Data and times can be confirmed on the sampling display.

Displaying data in an easy-to-see graph

Historical trend graph

The change in the collected data over time is displayed in an easy-to-understand form with a graph. The graph can be traced back to see the past data.

Recording the operator's operation

Operation log

Operations are saved to a log, so you can see who did what, and when. The log can also be used for a trend analysis of erroneous operation of operators.

Searching/sorting alarm and sampling history

Easy ascending/descending sorting and conditional search using symbols such as =, > or < of Alarm Part and Sampling Display.

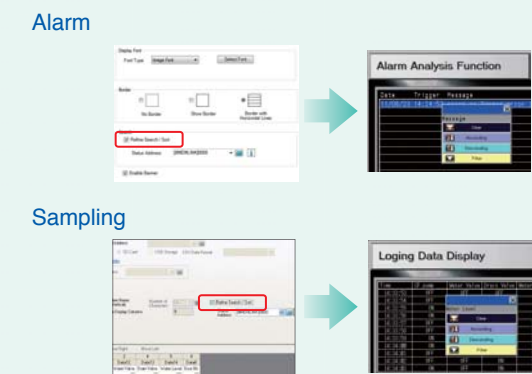

For details on features and supported models, please go to our website of software product page.
<http://www.pro-face.com/product/soft/gpproex/>

Enhanced Recipes

Even with different data like bit data, word data, and strings, recipes can be created for devices.

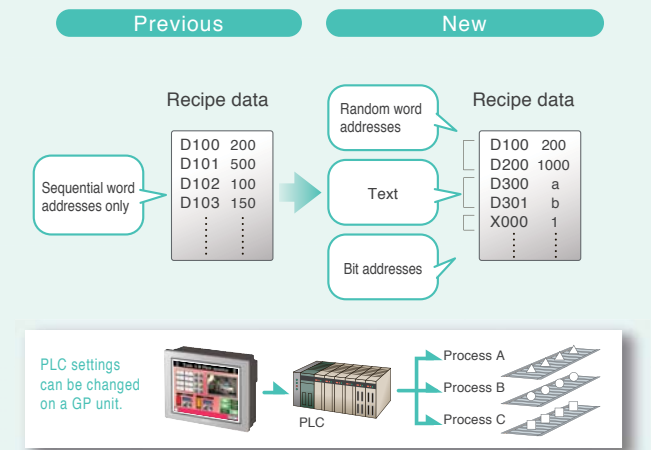

Sampling in different device formats

Text, bits, and variables can be mixed. Connected devices + internal addresses can also be set.

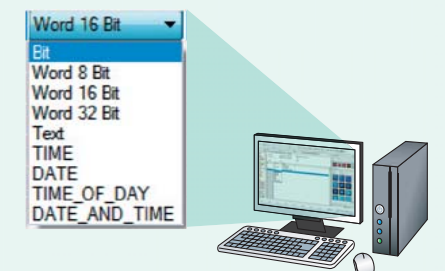

Alarm History Banner Display

Long alarm messages are automatically scrolled and displayed so their details can be checked.

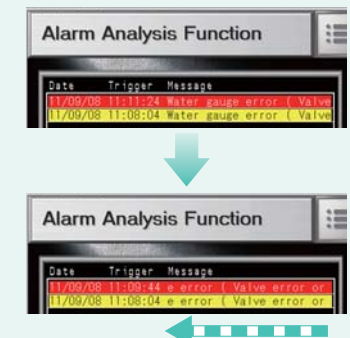

For details on features and supported models, please go to our website of software product page.
<http://www.pro-face.com/product/soft/gpproex/>

Faster and more efficient

Program with a familiar ladder language [Logic Program]

Screens and logic programming can be edited with the same software, so editing between parts and logic elements can be performed via drag and drop. Controller addresses can be directly written, allowing you to reduce development time.

The online editing function allows you to make program changes on a computer during operation.

You can make changes in a program without stopping operation - even while the control function is in operation. This enables work efficiency at startup and during maintenance.

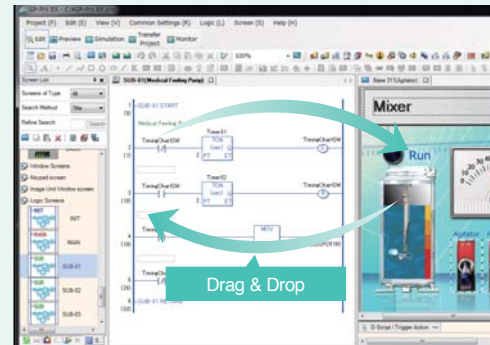

Supports Siemens AG's tag import function

Reduce screen development time by communicating with Siemens AG PLCs.

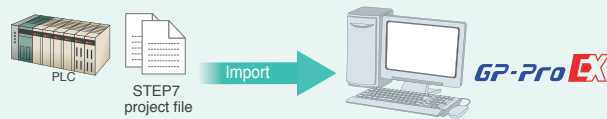

User Original Start Screen

Display a registered start screen (image) from when the power is turned on until when the initial base screen is displayed.



D-Script

Configure these settings based on trigger conditions including "Continuous Action", "Timer", "Bit Change", and "Condition Satisfied". Many functions are also provided including search (search and replace strings in the script) and debug functions (display messages and addresses on the unit).

Function	Bit operation	ON, OFF, clear
	Memory operation	Copy and shift, etc.
	CF file operation	File access, delete list output, etc.
	USB file operation	File access, delete list output, etc.
	SIO port operation	Send/receive data
	Printer operation	Send data
	Draw	Call screen, circle, straight line, square, etc.
	Others	Debug message and exit WinGP
	Bit turning ON Condition becoming true	
Tool Conditional	Trigger	Bit is ON/OFF, Timer, Condition is Satisfied, etc.
	Branching	IF, LOOP, etc.
	Comparison	AND, OR >, =, <, etc.
	Operation	+, x, bit operator, etc.

Create programs with our unique simplified language. D-Scripts created with GP-PRO/PBIII can be used unmodified so replacement is a breeze.

Windows® 7 64-bit

GP-Pro EX can be used in a wide range of PC operating environments such as Windows® 7, Windows® XP and Windows Vista®.

Edition	64/32-bit	Edition	64/32-bit
Ultimate	✓	Home Premium	✓
Enterprise	✓	Home Basic	✓
Professional	✓		

Some features are not supported. For details, visit our website.

Display/Hide parts

Control part visibility by device or operator. Save development time and reduce project file size.

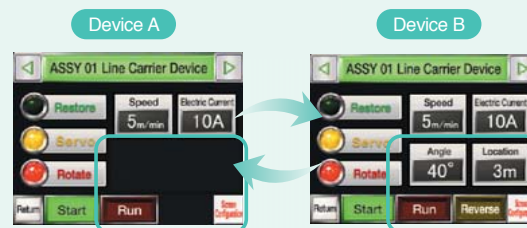

The same base screen may be used

This can reduce man-hours since separate screens do not need to be created.

Move/Rotate Graphics

Possible to move/rotate graphics, drawings and images, etc., allowing you to save time when creating screens with movement.

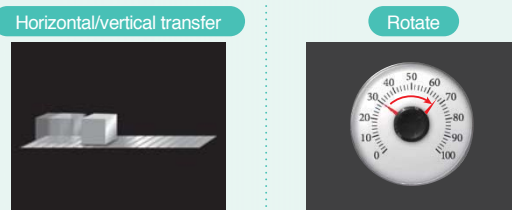

Express progress and movements on a conveyor

Animate meters to display realistic situations.

Remote monitoring of on-site situations in real-time

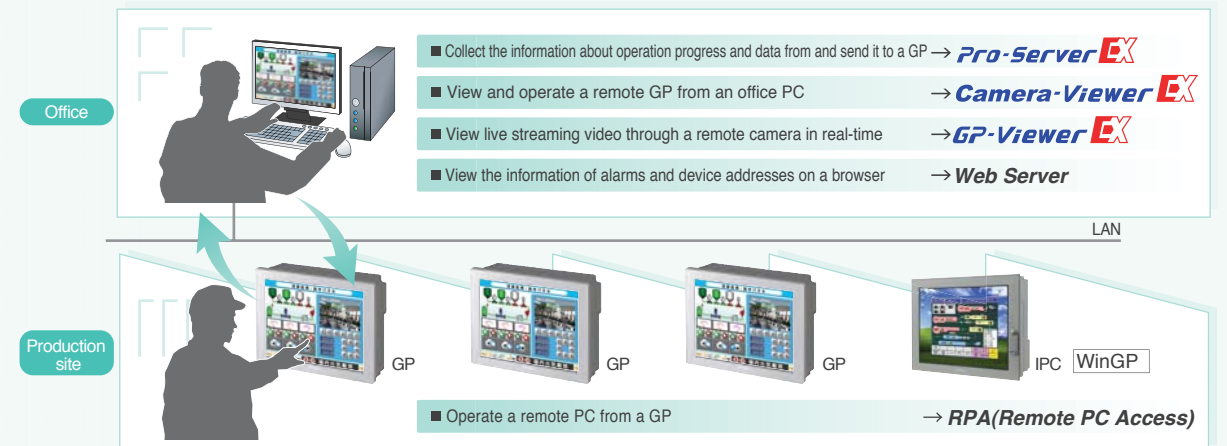

Data Management Software Pro-Server EX^{*1}

Collect information of operation progress on a PC via Ethernet network. Download operating instructions, such as recipes, from an office PC to a GP.

Assist the office and production sites with remote solutions

Web Server

Remote monitoring and maintenance can be done from office viewing the information of alarms and device addresses on a browser. Additionally, alarm notifications can be sent in real-time through RSS feeds.

RPA (Remote PC Access)^{*2}

View and operate a remote PC from an on-site GP. The GP shows the PC display on its screen.

WinGP

Reduce screen creation time with the same screen operations and communication settings as done on a GP.

WinGP allows you to create screens with the screen editor software, GP-Pro EX, on IPC. You can also reuse screen data for a GP for the use on IPC.



*1 To use Pro-Server EX, separate software must be purchased.

*2 To use GP-Viewer EX, Camera-Viewer EX, RPA, a separate license must be purchased.

Remote Monitoring Software GP-Viewer EX^{*2}

View and operate on-site GP display on a remote PC via Ethernet to monitor on-site status.

Operation Lock

To prevent operation mistakes made by operators, operations on GPs (or PCs) other than the one being operated can be locked.

Camera-Viewer EX^{*2}

Camera-Viewer EX allows you to view in real-time, record and play video through a remote camera connected to a GP on an office PC.

Automatically save on a PC

No need to load video to a PC. Video can be checked any time you need.

Video is stored in a PC's hard disk drive which is capable of long-time recording.

1. Check the time when the error occurred in alarm logs
2. Set the error time in Camera-Viewer EX
3. Check the status before and after the error occurred at a glance

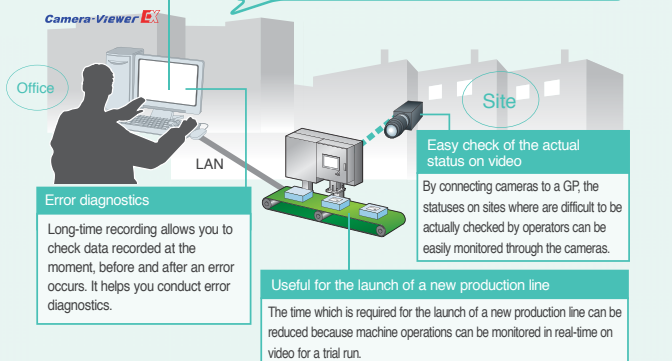

Error diagnostics

Long-time recording allows you to check data recorded at the moment, before and after an error occurs. It helps you conduct error diagnostics.

Easy check of the actual status on video

By connecting cameras to a GP, the statuses on sites where are difficult to be actually checked by operators can be easily monitored through the cameras.

Useful for the launch of a new production line

The time which is required for the launch of a new production line can be reduced because machine operations can be monitored in real-time on video for a trial run.

Easily check on-site statuses

Use Video for On-Site Adjustments

In combination with a COGNEX In-Sight vision system*1, the settings can be changed when watching images from the cameras on a GP unit on site.

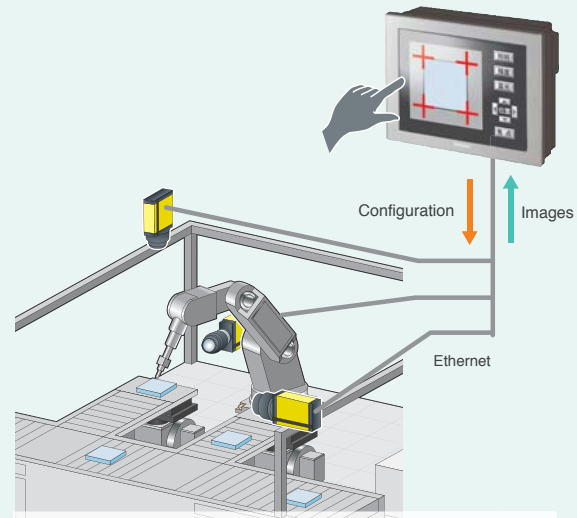

Trip events that occur in the inspection process can be monitored on screen. Inspection cameras can also be adjusted from GP.*2

- *1: GP3000 Series supports In-Sight Micro series and In-Sight 5000 series.
- *2: You can view video images from up to 3 cameras on a single screen. Up to 16 cameras can be connected to GP. Display position (X/Y), exposure time, focus, lighting and brightness can be adjusted on GP.

No need for a HMI or PC dedicated to a camera on site. Only a single GP is required to check and adjust inspection images and to operate equipment. This integrated functionality enhances maintainability.

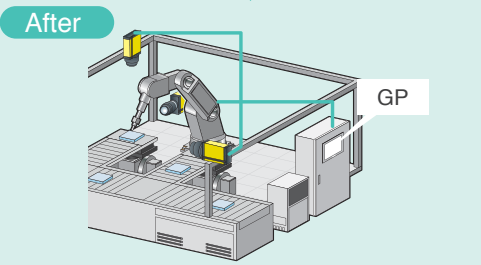
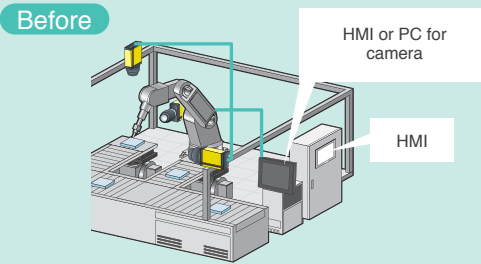

Easily appropriate past screens and sample parts

Indirect Device Setting

Only one screen is required to communicate with multiple devices. It allows you to reduce time for screen design.

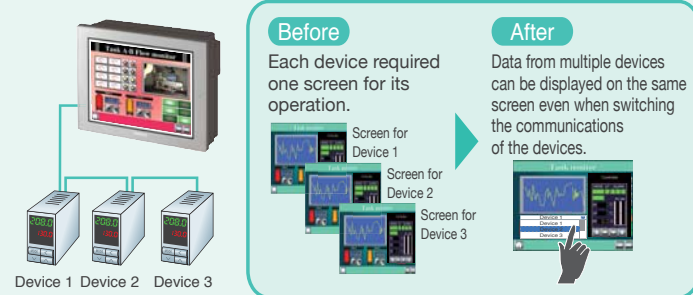

Project Converter

Project files created in GP-PRO/PBIII for Windows can be converted and used in GP-Pro EX.

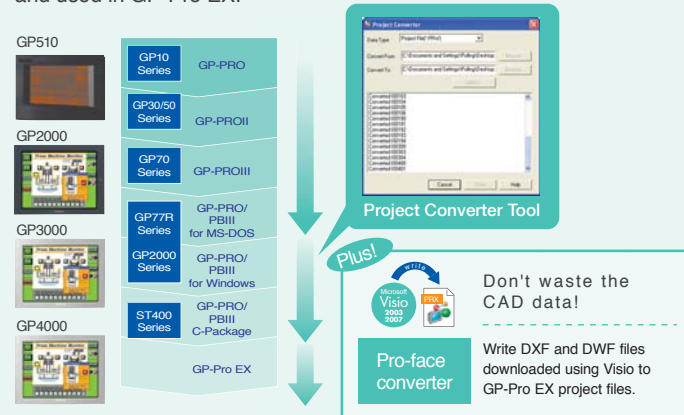

Appropriate Data from GP3000 Series to GP4000 Series

The data in GP4000 Series and GP3000 Series screen project data can be mutually appropriated.



Share Images and Parts

Parts and graphics you have created can be registered as a package. Save the packages to a server to share them among designers.

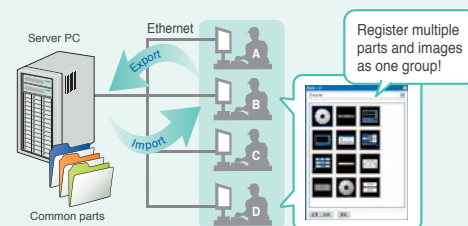

Pro-face meets your needs

GP4000

The New Pro-face Standard

- Features 65,536-color TFT
- LED backlight LCD + Lighting adjustment
- Alarm analysis function
- Ethernet I/F featured



GP3000

The GP3000 Series is available in four classes with diverse interfaces to suit your application perfectly

- M class offers real visualization through video recording and playback.
- C class offers control functions on HMI units
- S class comes equipped with an information network connection
- The handheld model features enhanced safety and ease of use



Graphic Logic Controller LT3000

Innovative all-in-one HMI integrated with control, operations, and display functions.

- Compact Design: Space-saving, all-in-one design
- Compact but with powerful functions
- A variety of interfaces



Industrial Personal Computer & Flat Panel Monitor IPC&FP

Industrial Flat Panel Monitors that can be used as displays for PCs on site.

- Expandability and Serviceability, "PL3000 Series"
- Value and High Usability, "PS3000 Series"
- DVI I/F Supported Flat Panel Monitors, "FP3000 Series"
- a rugged, high-performance built-in computer, "PS-4000 Series"



For details on catalog requests, please go to our website or contact the relevant Pro-face office.

Service & Support Information

With the Pro-face global brand, get the support you need anytime, anywhere!
We have a reliable service and support system.

Telephone Support
In an effort to gain greater customer satisfaction, Pro-face's telephone support services are based on the key words of availability, quick response and friendliness.

Web Support
The content of our "Otasuke Pro!" support site has been upgraded with services aimed at reducing development man-hours for the customer with contents such as FAQ and manual downloads.

Repair Services
Pro-face has eliminated loss throughout the entire repair process. We are constantly re-evaluating our systems to ensure satisfaction all of our customers.

Seminars
A variety of technical seminars are offered to help customers in order to get the most out of our Pro-face products. Easy-to-understand textbooks are prepared for what the customer wants to learn.

Manuals
So that even beginners can use products immediately, we aim to make manuals easy-to-understand. We have already received high reviews from many customers.

For details on features and supported models, please go to our website of software product page.
<http://www.pro-face.com/product/soft/gpproex/>

© List of available software

Product Name	Model No.	
GP-Pro EX Ver.3.0	PFXEXEDV30	
GP-Pro EX Editor License	PFXEXEDLS3X	
Pro-Server EX Developer	EX-SDV-V**	
Pro-Server EX Developer License	EX-SED-LICENSE	
Pro-Server EX Runtime License	EX-SRT-LICENSE	
MES Action License	EX-MES-LICENSE-V**	
GP-Viewer EX	Single license	EX-VIEWER-LICENSEv
	10 license	EX-VIEWER-LICENSE-10
	30 license	EX-VIEWER-LICENSE-30

Product Name	Model No.	
Camera-Viewer EX License	EXCAVELS	
RPA Client License	Single license	EX-RPA
	10 license	EX-RPA-10
	30 license	EX-RPA-30
Ladder Monitor License	Mitsubishi's PLC A Series	EX-LADM-MIT-Q02
	Mitsubishi's PLC A Series	EX-LADM-MIT-A01
	OMRON's PLC CS/CJ Series	EX-LADM-OMR-CJ01
Video Converter License	EX-MOVCON-LICENSE	
WinGP for IPC	EX-WINGP-IPC	
WinGP for PC/AT	EX-WINGP-PCAT	



We are always striving to bring you the high quality interface designed to provide a cohesive, evolving connection between customers and the quality products, service and support from around the world.

We provide our best possible support for each and every individual customer.

Our Environmental Policy and Compliance with the RoHS Directive

Pro-face has taken significant steps to meet increasingly stringent requirements for environmental preservation and has sought to comply with the RoHS Directive by adopting measures to eliminate specified harmful substances from existing products and products to be manufactured and sold beginning in 2006. For details, please refer to our web site or contact our sales office in your country.



www.pro-face.com

Global Network and Global Support

⚠ WARNING

HAZARD OF OPERATOR INJURY, OR UNINTENDED EQUIPMENT DAMAGE

Before operating any of these products, be sure to read all related manuals thoroughly. Failure to follow these instructions can result in death or serious injury, unintended equipment damage.

- For printing purposes, the colors in this catalog may differ from those of the actual unit.
- Actual user screens may differ from the screens shown here.
- Electric equipment should be installed, operated, serviced, and maintained only by qualified personnel. No responsibility is assumed by Digital for any consequences arising out of the use of this material.
- All product names used in this catalog are the registered trademarks or trademarks of their respective companies.
- All information contained in this catalog is subject to change without notice.

Global Head Office Digital Electronics Corporation Osaka, JAPAN Tel: +81 (0)6 6613 3116 Fax: +81 (0)6 6613 5888 http://www.pro-face.com info@pro-face.com	North/South American Head Office Pro-face America, Inc. Saline, MI U.S.A. Tel: +1 734 429 4971 Fax: +1 734 429 1010 http://www.profaceamerica.com sales.info@profaceamerica.com	Taiwan Pro-face Taiwan Co., Ltd. Taipei, TAIWAN Tel: +886 (0)2 2657 1121 Fax: +886 (0)2 2657 1021 http://www.proface.com.tw proface@proface.com.tw	European Head Office Pro-face Europe B.V. Hoofddorp, THE NETHERLANDS Tel: +31 (0)23 55 44 099 Fax: +31 (0)23 55 44 090 http://www.proface.eu info@proface.eu	Italy Pro-face Italia S.p.a. Bovisio Masciago (Milano), ITALY Tel: +39 (0)362 59 96 1 Fax: +39 (0)362 59 96 69 http://www.proface.it info@proface.it	Spain and Portugal Pro-face España Cardedeu (Barcelona), SPAIN Tel: +34 (0)93 846 07 45 Fax: +34 (0)93 846 48 68 http://www.proface.es info@proface.es
Australia and New Zealand Pro-face Australia Mt. Waverley, AUSTRALIA Tel: +61 (0)3 9550 7395 Fax: +61 (0)3 9550 7390 http://www.pro-face.com.au http://www.pro-face.co.nz pfau@pro-face.com	Singapore Pro-face Singapore TechPoint, Singapore Tel: +65-6832-5533 Fax: +65-6415-1605 http://www.proface.sg info@proface.sg	France Pro-face France S.A.S. Mity-Mory, FRANCE Tel: +33 (0)1 60 21 22 91 Fax: +33 (0)1 60 21 22 92 http://www.proface.fr info@proface.fr	Austria Pro-face Europe B.V. (Austria Office) Hagenberg, AUSTRIA Tel: +43 7236 3343 620 Fax: +43 7236 3343 629 http://www.proface.at info@proface.at	Northern Europe Pro-face Northern Europe ApS Roskilde, DENMARK Tel: +45 70 22 01 22 Fax: +45 70 22 01 33 http://www.proface.dk info@proface.dk	Sweden Pro-face Sweden AB Löddeköpinge (Malmö), SWEDEN Tel: +46 46 540 90 70 Fax: +46 46 71 27 90 http://www.proface.se info@proface.se
China Pro-face China International Trading Co., Ltd. Shanghai, P. R. CHINA Tel: +86 (0)21 6361 5175 Fax: +86 (0)21 6361 5176 http://www.proface.com.cn proface@proface.com.cn	South-East Asia Pacific Pro-face South-East Asia Pacific Co., Ltd. Bangkok, THAILAND Tel: +66 (0)2 617 5678 Fax: +66 (0)2 617 5688 http://www.proface.co.th support@proface.co.th	Germany Pro-face Deutschland GmbH Solingen, GERMANY Tel: +49 (0)212 258 260 Fax: +49 (0)212 258 2640 http://www.pro-face.de info@pro-face.de	Poland Pro-face Europe B.V. (Warszawa Office) Warszawa, POLAND Tel: +48 (22) 465 66 62 Fax: +48 (22) 465 66 67 http://www.proface.pl info@proface.pl	Russia Pro-face Europe B.V. (Russia Office) Saint-Petersburg, RUSSIA Tel: +007 (812) 336 47 06 Fax: +007 (812) 336 47 18 http://www.pro-face.ru info@pro-face.ru	Switzerland Pro-face Schweiz GmbH Regensdorf, SWITZERLAND Tel: +41 (0)43 343 7272 Fax: +41 (0)43 343 7279 http://www.proface.ch info@proface.ch
India Pro-face India Bangalore, INDIA Tel: +91 80 4333 3540/3541 Fax: +91 80 4333 3222 http://www.proface.com.in sales.proface@proface.com.in	South Korea Pro-face Korea Co., Ltd. Seoul, SOUTH KOREA Tel: +82 (0)2 2630 9850 Fax: +82 (0)2 2630 9860 http://www.proface.co.kr proface@proface.co.kr	United Kingdom Pro-face UK Ltd Coventry, ENGLAND Tel: +44 (0)2476 511288 Fax: +44 (0)2476 511489 http://www.proface.co.uk info@proface.co.uk			



2 rue René Laennec 51500 Taissy France
 Fax: 03 26 85 19 08, Tel : 03 26 82 49 29

E-mail: hvssystem@hvssystem.com
 Site web : www.hvssystem.com